

**ARXB07GALH**  
**ARXB09GALH**  
**ARXB12GALH**  
**ARXB14GALH**  
**ARXB18GALH**

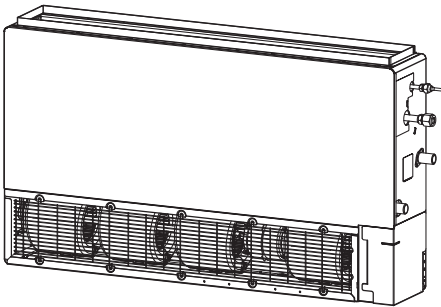

**ARXD07GALH**  
**ARXD09GALH**  
**ARXD12GALH**  
**ARXD14GALH**  
**ARXD18GALH**  
**ARXD24GALH**

Refer to the rating label for the serial number,  
manufactured year and month.

**FUJITSU GENERAL LIMITED**

## **OPERATING MANUAL**

INDOOR UNIT (Duct type)  
Keep this manual for future reference.

## **BEDIENUNGSANLEITUNG**

INNENGERÄT (Kanaltyp)  
Bewahren Sie dieses Handbuch für eine spätere Bezugnahme auf.

## **MODE D'EMPLOI**

UNITÉ INTÉRIEURE (type conduit)  
Conservez ce manuel pour pour toute référence ultérieure.

## **MANUAL DE FUNCIONAMIENTO**

UNIDAD INTERIOR (Tipo conducto)  
Conserve este manual para posibles consultas futuras.

## **MANUALE DI ISTRUZIONI**

UNITÀ INTERNA (tipo a condotto)  
Conservare questo manuale per consultazione futura.

## **ΕΓΧΕΙΡΙΔΙΟ ΛΕΙΤΟΥΡΓΙΑΣ**

ΕΣΩΤΕΡΙΚΗ ΜΟΝΑΔΑ (Τύπος αγωγού)  
Διατηρήστε το παρόν εγχειρίδιο για μελλοντική αναφορά.

## **MANUAL DE FUNCIONAMENTO**

UNIDADE INTERIOR (Tipo de tubagem)  
Guarde este manual para consulta futura.

## **РУКОВОДСТВО ПО ЭКСПЛУАТАЦИИ**

ВНУТРЕННИЙ МОДУЛЬ (Короб)  
Сохраните данное руководство для последующего использования.

## **KULLANIM KILAVUZU**

İÇ ÜNİTE (Kanal tipi)  
Bu kılavuzu ileride başvurmak üzere saklayın.

MADE IN P.R.C.



[Original instructions]

PART NO. 9374343331-02

English

Deutsch

Français

Español

Italiano

Ελληνικά

Português

Русский

Türkçe

# OPERATING MANUAL



PART NO. 9374343331-02  
VRF system indoor unit (Duct type)

## CONTENTS

SAFETY PRECAUTIONS.....	1
NAME OF PARTS.....	1
MANUAL AUTO OPERATION.....	2
OPERATING TIPS.....	2
CLEANING AND CARE.....	3
TROUBLESHOOTING.....	3
SPECIFICATIONS.....	4

## SAFETY PRECAUTIONS

- Before using the appliance, read these “PRECAUTIONS” thoroughly and operate in the correct way.
- The instructions in this section all relate to safety; be sure to maintain safe operating conditions.
- “WARNING” and “CAUTION” have the following meanings in these instructions:

 <b>WARNING</b>	This mark indicates procedures which, if improperly performed, might lead to the death or serious injury of the user.
 <b>CAUTION</b>	This mark indicates procedures which, if improperly performed, might possibly result in personal harm to the user, or damage to property.

### PRECAUTIONS ON USE

#### WARNING

- Do not keep exposing oneself to the direct wind of air conditioner for a long time.
- Do not insert fingers or objects into the outlet port or intake grilles.
- Except for EMERGENCY, never turn off main as well as sub breaker of the indoor units during operation. It will cause compressor failure as well as water leakage. First, stop the indoor unit by operating the control unit, converter or external input device and then cut the breaker. Make sure to operate through the control unit, converter or external input device.
- If the power supply cord of this appliance is damaged, it should only be replaced by the authorized service personal, since special purpose tools and specified cord are required.
- If any refrigerant happens to leak, extinguish any flames, ventilate the room and get in touch with authorized service personnel.

#### CAUTION

- Do not place animals or plants in the direct path of the airflow.
- Do not direct airflow at fireplaces or heating apparatus.
- Do not block or cover the inlet port and outlet port.
- Do not climb on, or place objects on, the air conditioner.
- Do not set flower vases or water containers on top of air conditioners.
- Do not hang objects from the indoor unit.
- Do not place anything below the indoor unit that should not get wet.
- Always turn off the electrical breaker whenever cleaning the air conditioner or the air filter.
- Do not pour water or cleaning solvent on the unit directly, or wash the unit with them.
- Do not expose the air conditioner directly to water.
- Do not operate the air conditioner with wet hands.
- Check the condition of the installation stand for damage.
- Operate only with air filters installed.
- Do not drink the water drained from the air conditioner.

- Do not apply any heavy pressure to radiator fins.
- Do not use inflammable gases near the air conditioner.
- Do not touch the piping during operation.
- Ensure that any electronic equipment is at least 1m away from either the indoor or outdoor units.
- This appliance is not intended for use by persons (including children) with reduced physical, sensory or mental capabilities, or lack of experience and knowledge, unless they have been given supervision or instruction concerning use of the appliance by a person responsible for their safety. Children should be supervised to ensure that they do not play with the appliance.

#### Note:

Switching the operating mode in the heat recovery system may require some time to prepare for operation. Please note that this is not a fault.

### PRECAUTIONS ON INSTALLATION

#### CAUTION

- Do not attempt to install this air conditioner by yourself.
- This unit contains no user-serviceable parts. Always consult authorized service personnel for repairs.
- When moving, consult authorized service personnel for disconnection and installation of the unit.
- The unit must be earthed (grounded).
- Make sure drain work is implemented properly for drainage.
- Avoid installing the air conditioner near a fireplace or other heating apparatus.
- When installing the indoor and outdoor units, take precautions to prevent access by infants.

## NAME OF PARTS

### ARXB 07/09/12/14/18

#### • Ceiling Concealed

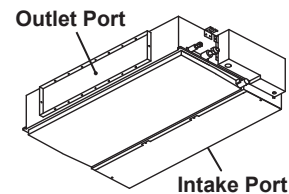

#### • Floor Standing Concealed

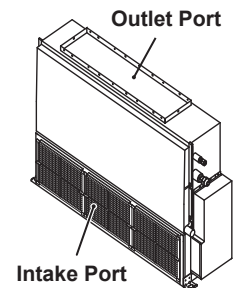

### ARXD 07/09/12/14/18/24

#### • Ceiling Concealed

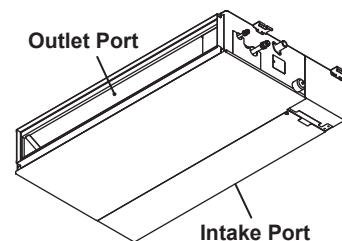

#### • Wall Mounted / Floor Standing Concealed

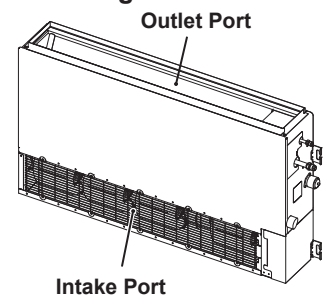

## Control unit (optional)

Types of remote controllers:

- Wireless remote controller  
(Be sure to use after connecting receiver unit.)
- Wired remote controller
- Simple remote controller

For operation method, please refer to the Operating Manual of each device.

# MANUAL AUTO OPERATION

Use the MANUAL AUTO operation in the event the remote control unit is lost or otherwise unavailable.

\*Limited to only when receiver unit is connected.



**CAUTION**

Do not press the MANUAL AUTO button with wet hands or pointed objects, otherwise an electric shock or malfunction may occur.

### Starting Operation

**Press the MANUAL AUTO button on the operating control panel.**

The operation can be set in the following setting.

Operating mode	AUTO: When Auto mode cannot be selected, it will operate in the same mode as the other indoor unit in the same system. (When other indoor unit in the same system doesn't operate, the air conditioner will operate in cooling.)
Fan speed	AUTO
Setting temperature	23 °C

### Stopping Operation

**Press the MANUAL AUTO button on the operating control panel.**

# OPERATING TIPS

### Operation and Performance

#### About priority state and standby state

- Multiple indoor units can be connected within the same system. Depending on the system, choice of operating mode are limited.

#### Cooling priority state:

When the other indoor units within the same system operate in cooling or dry mode, heating can not be selected at the same time.

#### Heating priority state:

When the other indoor units within the same system operate in heating mode, cooling and dry mode can not be selected at the same time.

#### Standby state:

The standby state activates when 2 or more indoor units start up at the same time in different mode. Any indoor unit other than priority mode will wait in standby state until priority mode changes (operation starts as soon as priority is switched).

At this time, the OPERATION indicator lamp (green) lights up and the TIMER indicator lamp (orange) flashes (limited to only when receiver unit is connected).

### Low ambient cooling

- When the outdoor temperature drops, the outdoor unit's fans may switch to Low Speed, or one of the fans may stop intermittently.

### Heating performance

- Heating mode operates on the heat-pump principle, absorbing heat from outdoor air and transferring that heat indoors. As a result, the operating performance is reduced as outdoor air temperature drops. If you feel that insufficient heating performance is being produced, we recommend you use this air conditioner in conjunction with another type of heating appliance.
- Heating mode heat your entire room by recirculating air throughout the room, with the result that some time may be required after first starting the air conditioner until the room is heated.

### Microcomputer-controlled automatic defrosting

- When using the Heating mode under conditions of low outdoor air temperature high humidity, frost may form on the outdoor unit, resulting in reduced operating performance. In order to prevent this kind of reduced performance, this unit is equipped with a Microcomputer-controlled automatic defrosting function. If frost forms, the air conditioner will temporarily stop, and the defrosting circuit will operate briefly (for about 4 to 15 minutes).  
During Automatic Defrosting operation, the OPERATION indicator lamp (green) will flash (limited to only when receiver unit is connected).

### Oil recovery operation

- Periodically, the oil recovery operation is performed in order to return compressor oil to the outdoor unit.  
During oil recovery operation, the OPERATION indicator lamp (green) will flash (for about 10 minutes) (limited to only when receiver unit is connected).

### Temperature and humidity range

- The temperature and humidity required for operating this product is as shown in the following table.

	Cooling/Dry Mode	Heating Mode
Outdoor temperature	Please refer to the specification of outdoor units.	
Indoor temperature	About 18 to 32 °C DB	About 10 to 30 °C DB
Indoor humidity	About 80% or less	

- If the air conditioner is operated under higher temperature conditions than those listed, the built-in protection circuit may operate to prevent internal circuit damage. Also, during Cooling and Dry modes, if the unit is used under conditions of lower temperature than those listed above, the heat-exchanger may freeze, leading to water leakage and other damage.
- If the unit is used for long periods under high-humidity conditions, condensation may form on the surface of the indoor unit, and drip onto the floor or other objects underneath.
- Do not use this unit for any purposes other than the Cooling, Heating, Dehumidifying, and air-circulation of rooms in ordinary dwellings.

# CLEANING AND CARE



- Before cleaning the unit, be sure to stop the unit and disconnect the power supply.
- Do not stand on an unstable platform when cleaning.
- When removing and replacing the air filters, be sure not to touch the heat exchanger, as personal injury may result.
- Do not clean the inside of the unit by yourself. To clean the inside, always consult authorized service personnel.
- When cleaning the unit's body, do not use water hotter than 40 °C, harsh abrasive cleansers, or volatile agents like benzene or thinner.
- If dirt is allowed to accumulate on the air filter, airflow will be reduced, lowering operating efficiency and increasing noise. During periods of normal use, the air filter should be cleaned every 2 weeks.

## Cleaning the air filter

### Cleaning

Cleaning the air filter

Remove dust with a vacuum cleaner or by washing. After washing, be sure to allow it to dry thoroughly in a shady place before reinstalling.

## When not using for an extended period

Leave the breaker on for at least 12 hours before starting operation when it is to be used again.

# TROUBLESHOOTING

## The following conditions are not breakdowns or operation failures.

### Doesn't operate immediately:

- If the unit is stopped and then immediately started again, the compressor will not operate for about 3 minutes, in order to prevent fuse blowouts.
- Whenever the electrical breaker is turned off then on again, the protection circuit will operate for about 3 minutes, preventing unit operation during that period.

### Airflow is weak or stops:

- When Heating operation is started, indoor unit's fan may temporarily stop, to allow internal parts to warm up.
- During Heating operation, if the room temperature rises above the thermostat setting, the outdoor unit will stop, and the indoor unit's fan will stop. If you wish to warm the room further, set the thermostat for a higher setting.
- During oil recovery operation, the airflow may stop for approximately 10 minutes. (See page 2)
- During Heating operation, the unit will temporarily stop operation (between 4 and 15 minutes) as the Automatic Defrosting mode operates. (See page 2)
- The fan may operate at low speed during Dry operation or when the unit is monitoring the room's temperature.
- In the monitor AUTO operation, the fan will operate at low speed.

### Flashing lamps:

(Limited to only when receiver unit is connected)

- The Operation indicator lamp (green) flashes:  
An oil recovery operation is being performed. (See page 2)
- The Operation indicator lamp (green) flashes:  
An automatic defrosting operation is being performed. (See page 2)
- The Operation indicator lamp (green) and Timer indicator lamp (orange) are flashing alternately:  
It has recovered from a power outage.
- The Operation indicator lamp (green) and Timer indicator lamp (orange) are flashing simultaneously:  
It is operating in trial operation mode. Ask a manager as there may be maintenance being conducted.
- The Operation indicator lamp (green) lights up and the Timer indicator lamp (orange) flashes:  
This is the standby state. (See page 2)

### Noise is heard:

- In the following conditions there are sounds of water flowing from the indoor unit and the operation sound becomes loud. These are the sounds of the flowing of refrigerant.
  - When operation starts
  - When oil recovery operation finishes
  - When automatic defrosting operation finishes
- During operation, a slight squeaking sound may be heard. This is the result of minute expansion and contraction of the panel due to temperature changes.
- During Heating operation, a sizzling sound may be heard occasionally. This sound is produced by the Automatic Defrosting operation. (See page 2)

### Smells:

- Some smell may be emitted from the indoor unit. This smell is the result of room smells (furniture, tobacco, etc.) which have been taken into the air conditioner.

### Fog comes out of the indoor unit:

- During Cooling operation, a thin mist may be seen emitted from the indoor unit. This results from the sudden Cooling of room air by the air emitted from the air conditioner, resulting in condensation and misting.

### Steam comes out of the indoor unit:

- During Heating operation, the outdoor unit's fan may stop, and steam may be seen rising from the unit. This is due to the Automatic Defrosting operation. (See page 2)

### Water is produced from the outdoor unit:

- During Heating operation, water may be produced from the outdoor unit due to the Automatic Defrosting operation.

## The following conditions may not be breakdowns so check again.

### Doesn't operate at all:

- Has there been a power failure?
- Has a fuse blown out, or a circuit breaker been tripped?
- Is the main power switch set to the OFF position?
- Are you trying to engage in an operation different from the priority state? (See page 2)
- Is it in standby state? (See page 2)

### The operation mode cannot be changed:

- Are you trying to change to an operation different from the priority conditions? (See page 2)

### Poor Cooling (or Heating) performance:

- Did you adjust the room temperature settings (thermostat) correctly?
- Is the air filter dirty? (See page 3)
- Are the air conditioner's inlet port or outlet port blocked?
- Is there a window or door open?
- In the case of Cooling operation, is a window allowing bright sunlight to enter? (Close the curtains.)
- In the case of Cooling operation, are there heating apparatus and computers inside the room, or are there too many people in the room?
- Is the fan speed set to low?

### Set the temperature lower than the room temperature and use it:

- Temperature does not fall down well. Temperature may not fall down depending on the room conditions. (While high humidity or the room temperature is high.) (See page 2)

## In the following situations stop operation immediately and get in touch with authorized service personnel.

- The problem cannot be solved even when the troubleshooting checks have been performed.
- The FILTER indicator lamp (red) is flashing very fast (when receiver unit is connected).
- The wired remote controller or simple remote controller indicate Er (when connected).
- It has burning smell.
- For details on marking the Flashing lamps, please refer to the Manual of "IR Receiver Unit" or "Wired Remote Controller".

# SPECIFICATIONS

MODEL	ARXB07 GALH	ARXB09 GALH	ARXB12 GALH	ARXB14 GALH	ARXB18 GALH	
POWER SOURCE	230 V ~ 50 Hz					
AVAILABLE VOLT-AGE RANGE	198 to 264 V (50Hz)					
COOLING CAPACITY	[kW]	2.2	2.8	3.6	4.5	5.6
	[BTU/h]	7,500	9,600	12,300	15,400	19,100
HEATING CAPACITY	[kW]	2.8	3.2	4.0	5.0	6.3
	[BTU/h]	9,600	10,900	13,600	17,100	21,500
INPUT POWER	[W]	46	55	63	90	96
CURRENT	[A]	0.24	0.25	0.30	0.40	0.42
SOUND PRESSURE LEVEL						
HIGH	dB [A]	29	31	30	33	36
MED	dB [A]	26	29	28	32	34
LOW	dB [A]	24	27	25	30	30
DIMENSIONS & WEIGHT						
HEIGHT	[mm]	217		217		
WIDTH	[mm]	663		953		
DEPTH	[mm]	595		595		
WEIGHT	[kg]	15		23		

- Acoustic Noise Information :  
The maximum sound pressure level is less than 70 dB (A) for both indoor unit and outdoor unit. According to IEC 704-1 and ISO 3744.
- Standard static pressure : 25 Pa

MODEL	ARXD 07 GALH	ARXD 09 GALH	ARXD 12 GALH	ARXD 14 GALH	ARXD 18 GALH	ARXD 24 GALH	
POWER SOURCE	230 V ~ 50/60 Hz						
AVAILABLE VOLT-AGE RANGE	198 to 264 V (50Hz) , 198 to 253 V (60Hz)						
COOLING CAPACITY	[kW]	2.2	2.8	3.6	4.5	5.6	7.1
	[BTU/h]	7,500	9,600	12,300	15,400	19,100	24,200
HEATING CAPACITY	[kW]	2.8	3.2	4.0	5.0	6.3	8.0
	[BTU/h]	9,600	10,900	13,600	17,100	21,500	27,300
INPUT POWER	[W]	44	50	54	92	83	122
CURRENT	[A]	0.31	0.35	0.38	0.61	0.55	0.78
SOUND PRESSURE LEVEL							
HIGH	dB [A]	28	29	30	34	34	35
MED	dB [A]	25	26	27	32	32	32
LOW	dB [A]	22	24	24	28	28	29
DIMENSIONS & WEIGHT							
HEIGHT	[mm]	198			198	198	
WIDTH	[mm]	700			900	1,100	
DEPTH	[mm]	620			620	620	
WEIGHT	[kg]	17		18	22	26	

- Acoustic Noise Information :  
The maximum sound pressure level is less than 70 dB (A) for both indoor unit and outdoor unit. According to IEC 704-1 and ISO 3744.
- Standard static pressure : 25 Pa

**FUJITSU GENERAL LIMITED**  
3-3-17, Suenaga, Takatsu-ku, Kawasaki 213-8502, Japan