

AUXM018GLAH
AUXM024GLAH
AUXM030GLAH
AUXK018GLAH
AUXK024GLAH
AUXK030GLAH
AUXK034GLAH
AUXK036GLAH
AUXK045GLAH
AUXK054GLAH

OPERATING MANUAL

INDOOR UNIT (Cassette type)
Keep this manual for future reference.

English

BEDIENUNGSANLEITUNG

INNENGERÄT (Kassettyp)
Bewahren Sie dieses Handbuch für eine spätere Bezugnahme auf.

Deutsch

MODE D'EMPLOI

UNITÉ INTÉRIEURE (Type cassette)
Conservez ce manuel pour toute référence ultérieure.

Français

MANUAL DE FUNCIONAMIENTO

UNIDAD INTERIOR (Tipo casete)
Conserve este manual para posibles consultas futuras.

Español

MANUALE DI ISTRUZIONI

UNITÀ INTERNA (tipo a cassetta)
Conservare questo manuale per consultazione futura.

Italiano

ΕΓΧΕΙΡΙΔΙΟ ΛΕΙΤΟΥΡΓΙΑΣ

ΕΣΩΤΕΡΙΚΗ ΜΟΝΑΔΑ (Τύπος κασέτας)
Διατηρήστε το παρόν εγχειρίδιο για μελλοντική αναφορά.

Ελληνικά

MANUAL DE FUNCIONAMENTO

UNIDADE INTERIOR (Tipo cassette)
Guarde este manual para consulta futura.

Português

РУКОВОДСТВО ПО ЭКСПЛУАТАЦИИ

ВНУТРЕННИЙ МОДУЛЬ (кассетного типа)
Сохраните данное руководство для последующего использования.

Русский

KULLANIM KILAVUZU

İÇ ÜNİTE (Kaset tipi)
Bu kılavuzu ileride başvurmak üzere saklayın.

Türkçe

Refer to the rating label with the serial number.
MADE IN P.R.C.



[Original instructions]

FUJITSU GENERAL LIMITED

PART NO. 9369313226-02

OPERATING MANUAL



PART NO. 9369313226-02
VRF system indoor unit (Cassette type)

CONTENTS

SAFETY PRECAUTIONS.....	1
NAME OF PARTS	1
MANUAL AUTO OPERATION	2
AIRFLOW DIRECTION	2
HUMAN SENSOR (Optional)	2
OPERATING TIPS	3
CLEANING AND CARE.....	3
TROUBLESHOOTING	4
SPECIFICATIONS.....	5

SAFETY PRECAUTIONS

- Before using the appliance, read these “PRECAUTIONS” thoroughly and operate in the correct way.
- The instructions in this section all relate to safety; be sure to maintain safe operating conditions.
- “WARNING” and “CAUTION” have the following meanings in these instructions:

 WARNING	This mark indicates procedures which, if improperly performed, might lead to the death or serious injury of the user.
 CAUTION	This mark indicates procedures which, if improperly performed, might possibly result in personal harm to the user, or damage to property.

PRECAUTIONS ON USE

WARNING

- Do not keep exposing oneself to the direct wind of air conditioner for a long time.
- Do not insert fingers or objects into the outlet port or intake grilles.
- Except for EMERGENCY, never turn off main as well as sub breaker of the indoor units during operation. It will cause compressor failure as well as water leakage. First, stop the indoor unit by operating the control unit, converter or external input device and then cut the breaker. Make sure to operate through the control unit, converter or external input device.
- If the power supply cord of this appliance is damaged, it should only be replaced by the authorized service personal, since special purpose tools and specified cord are required.
- If any refrigerant happens to leak, extinguish any flames, ventilate the room and get in touch with authorized service personnel.

CAUTION

- Do not place animals or plants in the direct path of the airflow.
- Do not direct airflow at fireplaces or heating apparatus.
- Do not block or cover the inlet port and outlet port.
- Do not climb on, or place objects on, the air conditioner.
- Do not set flower vases or water containers on top of air conditioners.
- Do not hang objects from the indoor unit.
- Do not place anything below the indoor unit that should not get wet.
- Always turn off the electrical breaker whenever cleaning the air conditioner or the air filter.
- Do not pour water or cleaning solvent on the unit directly, or wash the unit with them.
- Do not expose the air conditioner directly to water.
- Do not operate the air conditioner with wet hands.
- Check the condition of the installation stand for damage.
- Operate only with air filters installed.
- Do not drink the water drained from the air conditioner.
- Do not apply any heavy pressure to radiator fins.
- Do not use inflammable gases near the air conditioner.

- Do not touch the piping during operation.
- Ensure that any electronic equipment is at least 1 m away from either the indoor or outdoor units.
- This appliance is not intended for use by persons (including children) with reduced physical, sensory or mental capabilities, or lack of experience and knowledge, unless they have been given supervision or instruction concerning use of the appliance by a person responsible for their safety. Children should be supervised to ensure that they do not play with the appliance.

Note:

Switching the operating mode in the heat recovery system may require some time to prepare for operation. Please note that this is not a fault.

PRECAUTIONS ON INSTALLATION

CAUTION

- Do not attempt to install this air conditioner by yourself.
- This unit contains no user-serviceable parts. Always consult authorized service personnel for repairs.
- When moving, consult authorized service personnel for disconnection and installation of the unit.
- The unit must be grounded.
- Make sure drain work is implemented properly for drainage.
- Avoid installing the air conditioner near a fireplace or other heating apparatus.
- When installing the indoor and outdoor units, take precautions to prevent access by infants.

NAME OF PARTS

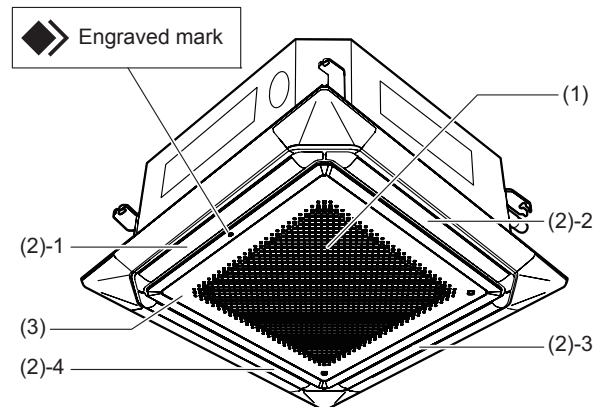

- (1) Air filter (in air intake grille)
- (2) Airflow direction flaps
The name of the outlet ports (in “Individual VT Hold setting” by the wired remote controller).
(2)-1: Outlet 1
(2)-2: Outlet 2
(2)-3: Outlet 3
(2)-4: Outlet 4
Please refer to the “AIRFLOW DIRECTION SETTING”.
- (3) Air intake grille
- (4) Control panel (optional)

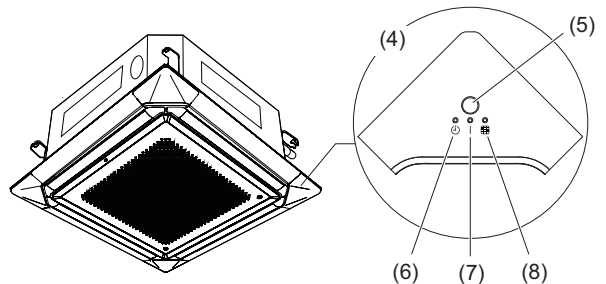

- (5) Remote control signal receiver and Manual auto button: Remote control signal receiver is the place to receive the signals from the remote controller. MANUAL AUTO button is used to operate it while remote controller is not available.

- (6) TIMER Indicator Lamp (Orange): It lights on while timer is working.
- (7) OPERATION Indicator Lamp (Green): It lights on while operating.
- (8) FILTER Indicator Lamp (Red): It lights on if the filter became dirty.
Clean the filter referring to "CLEANING AND CARE". It lights off when RESET button is pressed after cleaning.
- (9) Human sensor (optional)

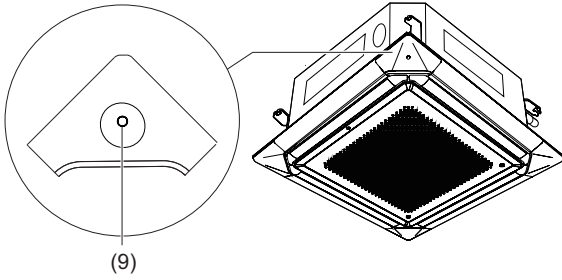

Control unit (optional)

Types of remote controllers:

- Wireless remote controller
- Wired remote controller
- Simple remote controller

For operation method, please refer to the operating manual of each device.

MANUAL AUTO OPERATION

Use the MANUAL AUTO operation in the event the remote control unit is lost or otherwise unavailable.

*Limited to only when IR receiver kit is attached.



Do not press the MANUAL AUTO button with wet hands or pointed objects, otherwise an electric shock or malfunction may occur.

Starting Operation

Press the MANUAL AUTO button on the operating control panel.

The operation can be set in the following setting.

Operating mode	AUTO: When Auto mode cannot be selected, it will operate in the same mode as the other indoor unit in the same system. (When other indoor unit in the same system doesn't operate, the air conditioner will operate in cooling.)
Fan speed	AUTO
Setting temperature	23 °C

Stopping Operation

Press the MANUAL AUTO button on the operating control panel.

AIRFLOW DIRECTION

The vertical wind direction can be controlled with the remote controller.

Vertical airflow direction

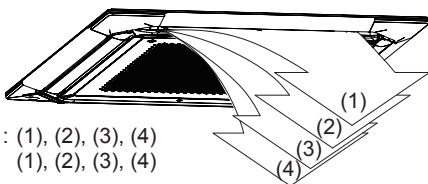

Cooling & Dry : (1), (2), (3), (4)
Heating : (1), (2), (3), (4)

Individual VT Hold

You can set the airflow direction of the outlet ports individually using a remote controller.
Setting of "Individual VT Hold setting" can be done in the remote controller of the following.

- UTY-RNR*Z* (wired remote controller)

Refer to the operating manual of the remote controller.

HUMAN SENSOR (Optional)

About the human sensor

The Human sensor detects whether there are people in the room by looking for movement by people in the room.

* Limited to only when Human sensor kit is attached.

Setting of Human sensor can be done in the remote controller of the following. Refer to the operating manual of the remote controller.

- UTY-RNR*Z* (wired remote controller)

About the Auto saving operation

If no one enters the room during the set time (15, 30, 60, 90, 120, 180 minutes), the set temperature will be automatically controlled.

(When someone comes back into the room, the Human sensor will detect this, and automatically revert to the original settings.)

About the Auto off operation

If no one enters the room during the set time (1 to 24 hours in 1 hour increments), the air conditioner will automatically stop operation.

NOTES:

- To restart operation, press the [On/Off] button of the remote controller.
- The Auto off operation may not operate even if there is no one in the room. The sensor may incorrectly detect people even if there is no one in the room.

Application range



- Do not place large objects near the Human sensor. Also keep heating units outside the sensor's detection area.

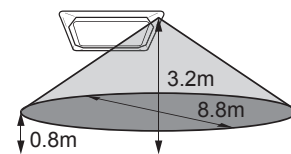

Equal sensitivity range of temperature
Ceiling height: 3.2 m
Detecting position: 0.8 m from floor surface

NOTES:

- When the installation height gets higher, the temperature sensitivity decreases.
- Energy Saving function may not work when the room temperature is very different from the temperature defined in temperature setting, such as when immediately after starting the operation.
- Since the Human sensor detects infrared light given out by people, there may be cases where this detection is incorrect.

Situations in which the sensor will detect no people in the room, even when there is someone there

- When the temperature is high and the difference with between people's body temperature is small. (Such as during the summer when the temperature is 30°C or higher.)
- When there is someone in the room, but they do not move for a long period of time.
- When someone is hidden behind a sofa, other furniture, glass, or in similar situations.
- When someone is wearing extremely thick clothing and has their back facing the sensor.

Situations in which the sensor will incorrectly detect people in the room, even when there is no one there

- When there is a dog or a cat moving around in the room.
- When the wind is making curtains or plants move.
- When there are heating units, humidifiers, or electric appliances such as oscillating electric fans operating.

OPERATING TIPS

Operation and Performance

About priority state and standby state

- Multiple indoor units can be connected within the same system. Depending on the system, choice of operating mode are limited.

Cooling priority state:

When the other indoor units within the same system operate in cooling or dry mode, heating can not be selected at the same time.

Heating priority state:

When the other indoor units within the same system operate in heating mode, cooling and dry mode can not be selected at the same time.

Standby state:

The standby state activates when 2 or more indoor units start up at the same time in different mode. Any indoor unit other than priority mode will wait in standby state until priority mode changes (operation starts as soon as priority is switched).

At this time, the OPERATION indicator lamp (green) lights up and the TIMER indicator lamp (orange) flashes.

Low ambient cooling

- When the outdoor temperature drops, the outdoor unit's fans may switch to Low Speed, or one of the fans may stop intermittently.

Heating performance

- Heating mode operates on the heat-pump principle, absorbing heat from outdoor air and transferring that heat indoors. As a result, the operating performance is reduced as outdoor air temperature drops. If you feel that insufficient heating performance is being produced, we recommend you use this air conditioner in conjunction with another type of heating appliance.
- Heating mode heat your entire room by recirculating air throughout the room, with the result that some time may be required after first starting the air conditioner until the room is heated.

Microcomputer-controlled automatic defrosting

- When using the Heating mode under conditions of low outdoor air temperature high humidity, frost may form on the outdoor unit, resulting in reduced operating performance. In order to prevent this kind of reduced performance, this unit is equipped with a Microcomputer-controlled automatic defrosting function. If frost forms, the air conditioner will temporarily stop, and the defrosting circuit will operate briefly (for about 4 to 15 minutes). During Automatic Defrosting operation, the OPERATION indicator lamp (green) will flash.

Oil recovery operation

- Periodically, the oil recovery operation is performed in order to return compressor oil to the outdoor unit. During oil recovery operation, the OPERATION indicator lamp (green) will flash (for about 10 minutes).

Temperature and humidity range

- The temperature and humidity required for operating this product is as shown in the following table.

	Cooling/Dry Mode	Heating Mode
Outdoor temperature	Please refer to the specification of outdoor units.	
Indoor temperature	18 to 32 °C DB	10 to 30 °C DB
Indoor humidity	About 80% or less	

- If the air conditioner is operated under higher temperature conditions than those listed, the built-in protection circuit may operate to prevent internal circuit damage. Also, during Cooling and Dry modes, if the unit is used under conditions of lower temperature than those listed above, the heat-exchanger may freeze, leading to water leakage and other damage.
- If the unit is used for long periods under high-humidity conditions, condensation may form on the surface of the indoor unit, and drip onto the floor or other objects underneath.
- Do not use this unit for any purposes other than the Cooling, Heating, Dehumidifying, and air-circulation of rooms in ordinary dwellings.

CLEANING AND CARE

CAUTION

- Before cleaning the unit, be sure to stop the unit and disconnect the power supply.
- Do not stand on an unstable platform when cleaning.
- When removing and replacing the air filters, be sure not to touch the heat exchanger, as personal injury may result.
- Be sure the intake grille is installed securely.
- Do not clean the inside of the unit by yourself. To clean the inside, always consult authorized service personnel.
- When cleaning the unit's body, do not use water hotter than 40 °C, harsh abrasive cleansers, or volatile agents like benzene or thinner.
- Do not remove any part from the unit except for the filter.
- If dirt is allowed to accumulate on the Air Filter, airflow will be reduced, lowering operating efficiency and increasing noise.
- During periods of normal use, the air filters should be cleaned every 2 months.

Cleaning the Air Filter

When the filter lamp flashes, remove and clean the filter.

1. Push the intake grille push-buttons (two places) and open the intake grille.

2. Pull out the filter from the intake grille.

1.

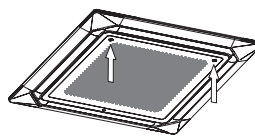

2.

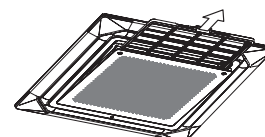

3. Clean the air filters.

Remove the dust from the air filters by vacuuming or washing them. After washing, allow the air filters to dry thoroughly in an area protected from sunlight.

- Dust can be cleaned from the air filter either with a vacuum cleaner, or by washing the filter in a solution of mild detergent and warm water. If you wash the filter, be sure to allow it to dry thoroughly in a shady place before reinstalling.
- If dirt is allowed to accumulate on the air filter, air flow will be reduced, lowering operating efficiency and increasing noise.

4. Re-attach the air filters to the intake grille.

- (1) Replace the air filter into its holder.
- (2) Make sure that the air filter makes contact with the filter stopper when it is replaced into its holder.

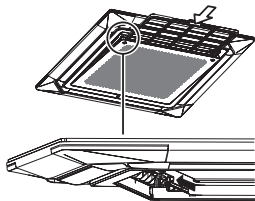

5. Close the intake grille and push the intake grille's hooks outward.

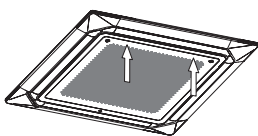

- Dust can be cleaned from the air filter either with a vacuum cleaner, or by washing the filter in a solution of mild detergent and warm water. If you wash the filter, be sure to allow it to dry thoroughly in a shady place before reinstalling.
- If dirt is allowed to accumulate on the air filter, airflow will be reduced, lowering operating efficiency and increasing noise.
- After turning the power on, press the filter button on the remote control to turn off the filter lamp. (Refer to the operation manual packed with remote control unit for details.)

Cleaning the body

Wash the body with warm water, and then dry with a clean and soft cloth.

When not using for an extended period

Leave the breaker on for at least 12 hours before starting operation when it is to be used again.

TROUBLESHOOTING

The following conditions are not breakdowns or operation failures.

Doesn't operate immediately:

- If the unit is stopped and then immediately started again, the compressor will not operate for about 3 minutes, in order to prevent fuse blowouts.
- Whenever the electrical breaker is turned off then on again, the protection circuit will operate for about 3 minutes, preventing unit operation during that period.

Airflow is weak or stops:

- When Heating operation is started, indoor unit's fan may temporarily stop, to allow internal parts to warm up.
- During Heating operation, if the room temperature rises above the thermostat setting, the outdoor unit will stop, and the indoor unit's fan will stop. If you wish to warm the room further, set the thermostat for a higher setting.
- During oil recovery operation, the airflow may stop for approximately 10 minutes. (See page 2)
- During Heating operation, the unit will temporarily stop operation (between 4 and 15 minutes) as the Automatic Defrosting mode operates. (See page 2)

- The fan may operate at low speed during Dry operation or when the unit is monitoring the room's temperature.
- In the monitor AUTO operation, the fan will operate at low speed.

Flashing lamps:

- The OPERATION indicator lamp (green) flashes:
An oil recovery operation is being performed. (See page 2)
- The OPERATION indicator lamp (green) flashes:
An automatic defrosting operation is being performed. (See page 2)
- The OPERATION indicator lamp (green) and TIMER indicator lamp (orange) are flashing alternately:
It has recovered from a power outage.
- The OPERATION indicator lamp (green) and TIMER indicator lamp (orange) are flashing simultaneously:
It is operating in trial operation mode. Ask a manager as there may be maintenance being conducted.
- The OPERATION indicator lamp (green) lights up and the TIMER indicator lamp (orange) flashes:
This is the standby state. (See page 2)

Noise is heard:

- In the following conditions there are sounds of water flowing from the indoor unit and the operation sound becomes loud. These are the sounds of the flowing of refrigerant.
When operation starts
When oil recovery operation finishes
When automatic defrosting operation finishes
- During operation, a slight squeaking sound may be heard. This is the result of minute expansion and contraction of the panel due to temperature changes.
- During Heating operation, a sizzling sound may be heard occasionally. This sound is produced by the Automatic Defrosting operation. (See page 2)

Smells:

- Some smell may be emitted from the indoor unit. This smell is the result of room smells (furniture, tobacco, etc.) which have been taken into the air conditioner.

Fog comes out of the indoor unit:

- During Cooling operation, a thin mist may be seen emitted from the indoor unit. This results from the sudden Cooling of room air by the air emitted from the air conditioner, resulting in condensation and misting.

Steam comes out of the indoor unit:

- During Heating operation, the outdoor unit's fan may stop, and steam may be seen rising from the unit. This is due to the Automatic Defrosting operation. (See page 2)

Water is produced from the outdoor unit:

- During Heating operation, water may be produced from the outdoor unit due to the Automatic Defrosting operation.

The following conditions may not be breakdowns so check again.

Doesn't operate at all:

- Has there been a power failure?
- Has a fuse blown out, or a circuit breaker been tripped?
- Is the main power switch set to the OFF position?
- Are you trying to engage in an operation different from the priority state? (See page 3)
- Is it in standby state? (See page 3)
- Is the Auto off operation of the Human sensor setting active? (See page 2)

The operation mode cannot be changed:

- Are you trying to change to an operation different from the priority conditions? (See page 3)

Poor Cooling (or Heating) performance:

- Did you adjust the room temperature settings (thermostat) correctly?
- Is the air filter dirty? (See page 3)
- Are the air conditioner's inlet port or outlet port blocked?
- Is there a window or door open?
- In the case of Cooling operation, is a window allowing bright sunlight to enter? (Close the curtains.)

- In the case of Cooling operation, are there heating apparatus and computers inside the room, or are there too many people in the room?
- Is the fan speed set to low?
- Is the Auto saving operation of the Human sensor setting active? (See page 2)

Set the temperature lower than the room temperature and use it:

- Temperature does not fall down well. Temperature may not fall down depending on the room conditions. (While high humidity or the room temperature is high.) (See page 3)

In the following situations stop operation immediately and get in touch with authorized service personnel.

- The problem cannot be solved even when the troubleshooting checks have been performed.
- The FILTER indicator lamp (red) is flashing very fast.
- The wired remote controller or simple remote controller indicate Er (when connected).
- It has burning smell.

SPECIFICATIONS

MODEL	AUXM 018GLAH	AUXM 024GLAH	AUXM 030GLAH	AUXK 018GLAH	AUXK 024GLAH	
POWER SOURCE	220-240V ~ 50Hz, 230V ~ 60Hz					
AVAILABLE VOLT-AGE RANGE	198 to 264 V (50Hz) , 198 to 253 V (60Hz)					
COOLING CAPACITY	[kW]	5.6	7.1	9.0	5.6	7.1
	[BTU/h]	19,100	24,200	30,700	19,100	24,200
HEATING CAPACITY	[kW]	6.3	8.0	10.0	6.3	8.0
	[BTU/h]	21,500	27,300	34,100	21,500	27,300
INPUT POWER	[W]	20	25	49	40	40
CURRENT	[A]	0.20	0.24	0.41	0.34	0.34
SOUND PRESSURE LEVEL						
HIGH	dB [A]	33	35	40	38	38
MED - HIGH	dB [A]	32	33	36	37	37
MED	dB [A]	31	32	34	36	36
MED - LOW	dB [A]	30	31	32	35	35
LOW	dB [A]	29	30	31	34	34
QUIET	dB [A]	28	28	28	33	33
DIMENSIONS & WEIGHT						
HEIGHT	[mm]	246			288	
WIDTH	[mm]	840				
DEPTH	[mm]	840				
WEIGHT	[kg]	24	24.5		26.5	

MODEL	AUXK 030GLAH	AUXK 034GLAH	AUXK 036GLAH	AUXK 045GLAH	AUXK 054GLAH	
POWER SOURCE	220-240V ~ 50Hz, 230V ~ 60Hz					
AVAILABLE VOLT-AGE RANGE	198 to 264 V (50Hz) , 198 to 253 V (60Hz)					
COOLING CAPACITY	[kW]	9.0	10.0	11.2	12.5	14.0
	[BTU/h]	30,700	34,100	38,200	42,700	47,800
HEATING CAPACITY	[kW]	10.0	11.2	12.5	14.0	16.0
	[BTU/h]	34,100	38,200	42,700	47,800	54,600
INPUT POWER	[W]	47	47	61	89	116
CURRENT	[A]	0.38	0.38	0.47	0.67	0.86
SOUND PRESSURE LEVEL						
HIGH	dB [A]	39	39	41	44	47
MED - HIGH	dB [A]	38	38	40	42	45
MED	dB [A]	37	37	38	40	42
MED - LOW	dB [A]	36	36	37	38	39
LOW	dB [A]	35	35	35	36	36
QUIET	dB [A]	33	33	33	33	33
DIMENSIONS & WEIGHT						
HEIGHT	[mm]	288				
WIDTH	[mm]	840				
DEPTH	[mm]	840				
WEIGHT	[kg]	29.5				

- Acoustic Noise Information:
The maximum sound pressure level is less than 70 dB (A) for both indoor unit and outdoor unit. According IEC 704-1 and ISO 3744.
- This product contains fluorinated greenhouse gases.

FUJITSU GENERAL LIMITED
3-3-17, Suenaga, Takatsu-ku, Kawasaki 213-8502, Japan