

Auto Louver Grille

INSTALLATION MANUAL

For authorized service personnel only.

Contents

1. SAFETY PRECAUTIONS	1
2. STANDARD PARTS	1
3. DIMENSION	1
4. LOCATION	2
5. INSTALLATION METHOD	2
5.1. Mounting the bracket frame	2
5.2. Mounting the grille	3
6. WIRING-INSIDE THE EQUIPMENT	3
6.1. For Type-A	3
6.2. For Type-B	3
7. WIRING-OUTSIDE THE EQUIPMENT	4
8. FIELD SETTING	4
9. TEST OPERATION	4

1. SAFETY PRECAUTIONS

- Be sure to read this Manual thoroughly before installation.
- The warnings and precautions indicated in this Manual contain important information pertaining to your safety. Be sure to observe them.
- Hand this Manual, together with the Operating Manual to the customer. Request the customer to keep them on hand for future use, such as for relocating or repairing the unit.

 WARNING	This mark indicates procedures which, if improperly performed, might lead to the death or serious injury of the user.
Install at a location that can sufficiently withstand the weight. If the strength is inadequate, grille may fall and cause an injury.	
Firmly install the grille. Or else, it may fall and cause an injury.	
Do not turn ON the power until all work has been completed. Turning ON the power before the work is completed can cause serious accidents such as electric shock or fire.	
Never touch electrical components immediately after the power supply has been turned off. Electrical shock may occur. After turning off the power, always wait 5 minutes or more before touching electrical components.	

 CAUTION	This mark indicates procedures which, if improperly performed, might possibly result in personal harm to the user, or damage to property.
Do not install the unit in the following areas	
<ul style="list-style-type: none"> • In the upper part of the vicinity of room entrance. It may cause condensation on the outlet port. • Near a wall surface. It may cause condensation on the wall during cooling. • Area filled with mineral oil or containing a large amount of splashed oil or steam, such as a kitchen. 	
Perform heat insulation and field setting according the manual. Not installing as per the instructions may cause condensation.	
Do not move the up-down louvers manually. It may cause a malfunction.	
Don't install the unit where it will be exposed to direct sunlight. Or else, it may cause a change in color.	
When the installation area is exposed to direct sunlight, take measures to block the light such as covering the grille surface with a sheet. Or else, it may cause a change in color.	
Use an appropriate Grille that is compatible with the indoor unit. Refer to Design & Technical manual for further details. If not used with the correct combination, it may cause condensation.	

2. STANDARD PARTS

- The following installation parts are supplied. Use them as required.

Name and shape	Q'ty
Installation manual (This manual)	1
Operating manual	1
Grille	1
Bracket frame	1
Screw-A	16
Screw-B	6
Cable clip	2
Binder	3
Bushing	1

3. DIMENSION

Diagrams showing connection between bracket frame and Grille are given below.

UTD-G*SA

[Top View]

Unit : mm

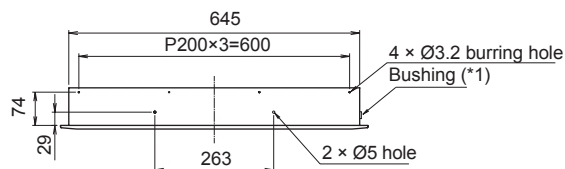

[Front View]

[Side View]

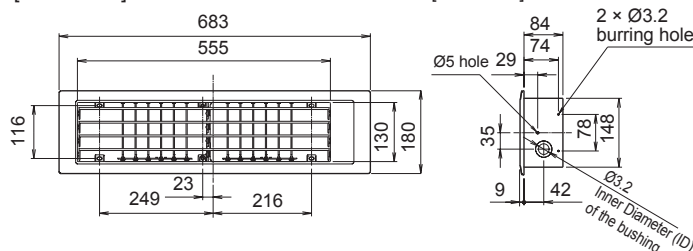

English

Deutsch

Français

Español

Italiano

Ελληνικά

Português

Русский

Türkçe

UTD-G*SB

[Top View]

Unit : mm

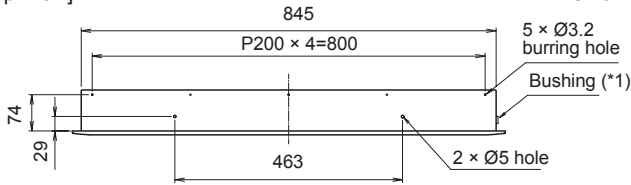

[Front View]

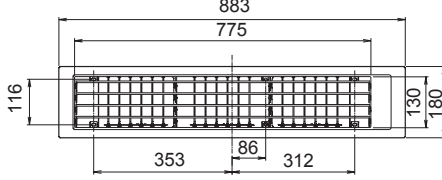

[Side View]

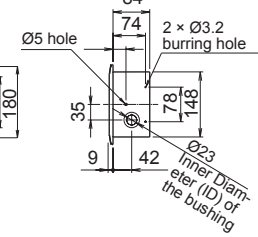

UTD-G*SC

[Top View]

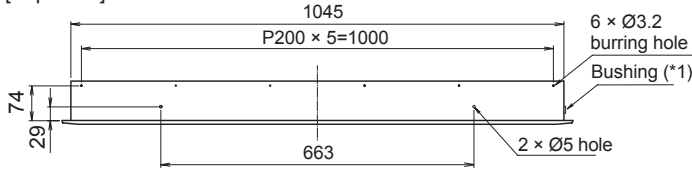

[Front View]

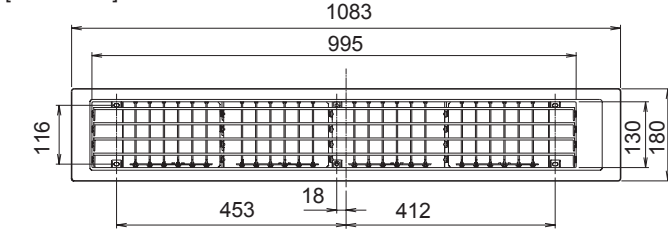

[Side View]

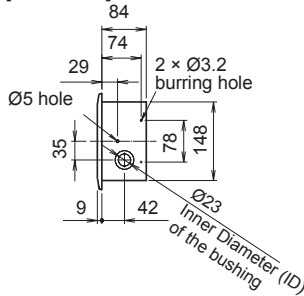

*1) Detailed drawing of bushing

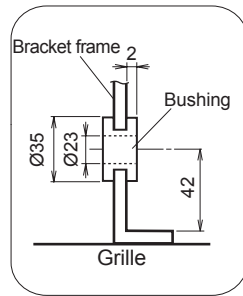

4. LOCATION

Select the installation location that meets the following requirement and that is approved by the customer.

- Cold and warm air should reach the entire room.

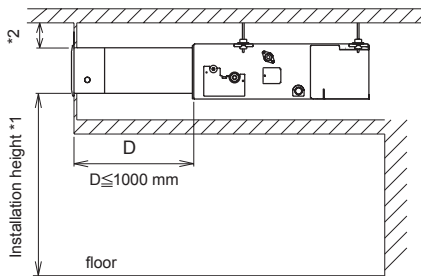

*1) Refer to Design & Technical manual for Air velocity distribution and Air temperature distribution during heating.

*2) If the distance from the ceiling is not adequate, it may cause mildew stains on the wall or the ceiling. (Ensure to fix at least 150 mm away from any surface of the equipment.)

5. INSTALLATION METHOD

5.1. Mounting the bracket frame

A: When directly connecting to the indoor unit

- (1) Bore a hole in the wall

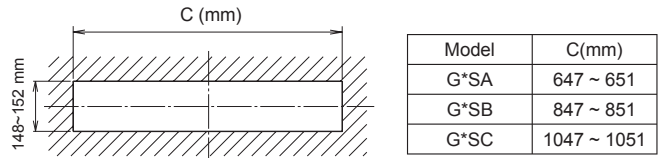

- (2) Mount the bracket frame on the wall. Mount so that the wiring hole is on the right side of the frame.
- (3) Fasten the bracket frame and the indoor unit with Screw-A (Accessories).

Model	Screw-A
G*SA	12 places
G*SB	14 places
G*SC	16 places

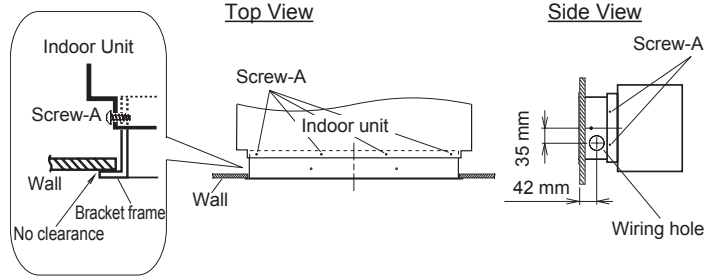

- (4) Insulate the bracket frame. (Insulation material: Field supply) Create a slit in the insulation material on the wiring hole so that the cable can pass through.

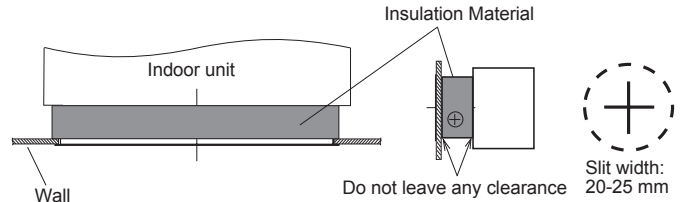

B: When using a rectangular duct

CAUTION

Securely fasten the bracket frame on a stable foundation. Or else, it may cause an injury.

- (1) Bore a hole in the wall. The rectangular duct dimensions follow figure below. Create a wiring hole in the rectangular duct (right side) if the wiring hole is covered with the rectangular duct.

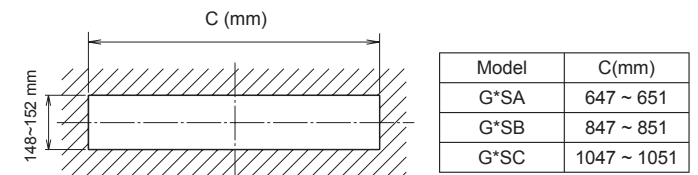
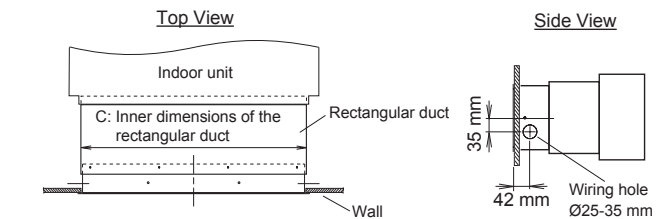

- (2) Mount the bracket frame on the rectangular duct. Fasten it with Screw-A (Accessories) or Rivet (Field supply). Mount so that the wiring hole is on the right side of the frame.

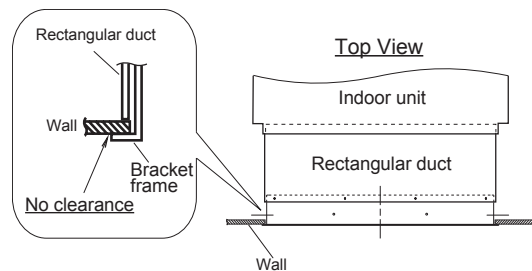

- Insulate the rectangular duct. (Insulation material: Field supply)
Create a slit in the insulation material on the wiring hole so that the cable can pass through.

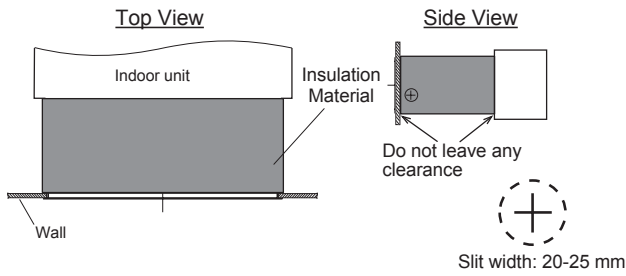

5.2. Mounting the grille

- Pass the cable through the wiring hole. Insert the cable so that the wiring length from the grille to wiring hole is 150 mm.
- Seal the wiring hole with putty from the inner side.
- Mount the grille on the bracket frame.
Mount so that there is no clearance between the grille and the wall.

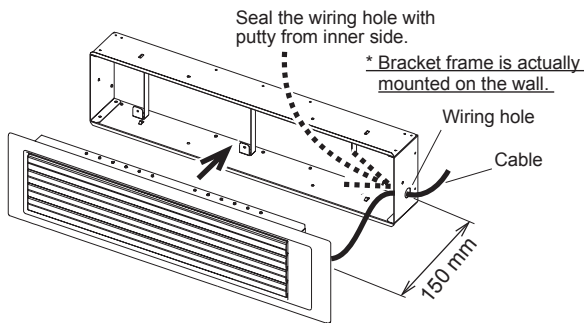

- Fasten the Screw-B (6 places, Accessories).
After fastening the 2 Screw-B in the center, fasten 4 Screw-B on both the sides.

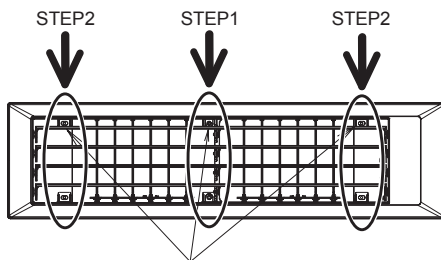

* Fasten the screw with the protective tape affixed on the up-down louvers.
Remove the protective tape after the work is completed.

6. WIRING-INSIDE THE EQUIPMENT

CAUTION

- To protect the cable insulation after opening a knockout hole, remove any burrs from the edge of the hole.
- Do not bind the power supply cable and other cables together.

Controller PCB located inside the electric equipment box differs according to the model. Set according to the Controller PCB.

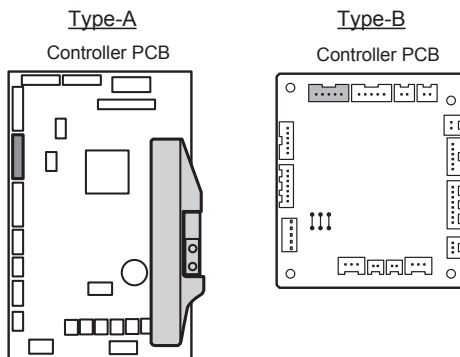

6.1. For Type-A

- Connect the cable to the Auto louver grille terminal (CN12) of the controller PCB of the indoor unit.

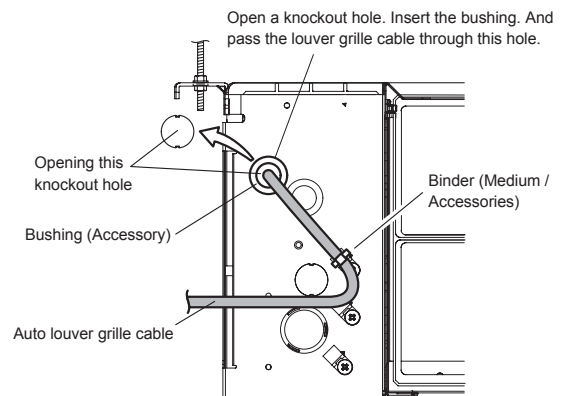
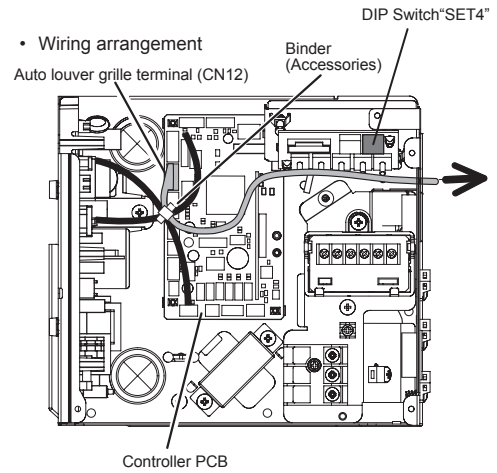

* Collect all the cables if there are any other cables. Refer to the installation manual of the indoor unit for details.

- Set SW2 of DIP Switch "SET4" to ON.

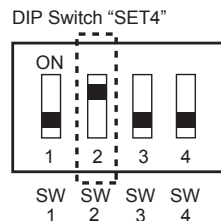

6.2. For Type-B

- Connect the cable to the Auto louver grille terminal (CN11) of the controller PCB of the indoor unit.

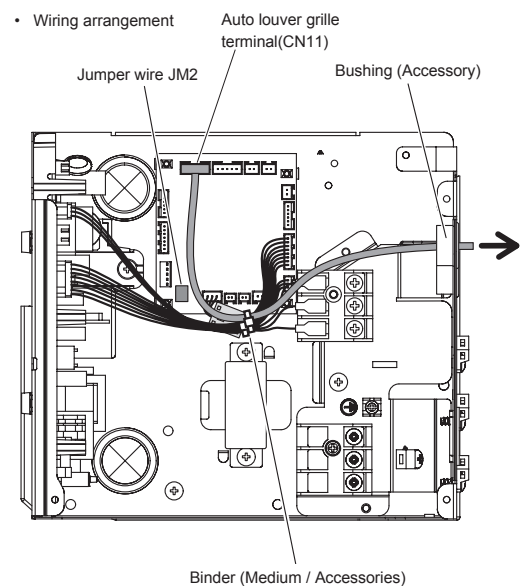

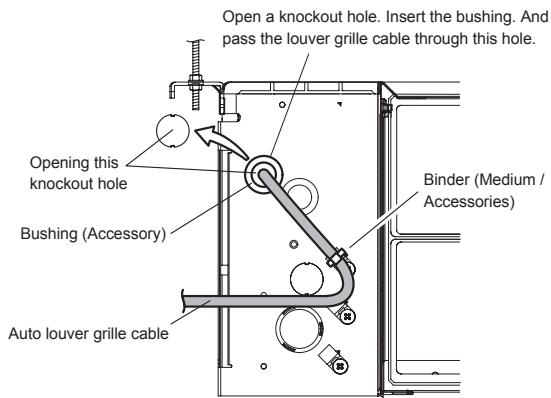

* Collect all the cables if there are any other cables. Refer to the installation manual of the indoor unit for details.

(2) Cut jumper wire JM2

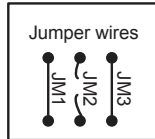

7. WIRING-OUTSIDE THE EQUIPMENT

(1) Firmly fasten the cable in line with the side surface of the indoor unit with cable clip. Fasten the cable clip jointly with the screw of the control box cover.

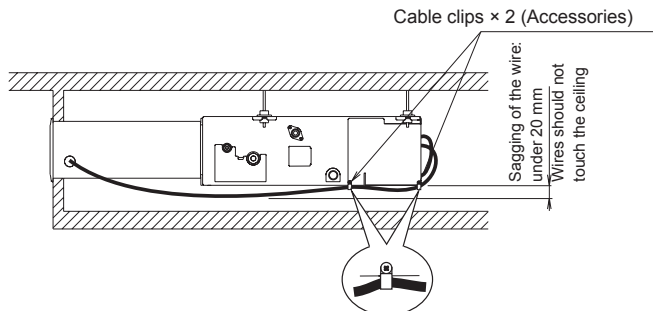

Bundle the extra cables as shown in the diagram.

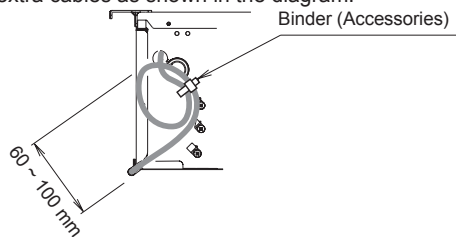

8. FIELD SETTING

⚠ CAUTION

Set the static pressure settings correctly. If not set correctly, it may cause a condensation.

Perform static pressure setting according to the static pressure on the inlet side. For details of static pressure setting, refer to the corresponding contents of "Field setting" in indoor unit installation manual. Perform the static pressure settings with the up-down louvers and right-left louvers in horizontal position.

9. TEST OPERATION

Adjust the right-left louvers so that warm air and cold air reaches the entire room.

Refer to the Operation Manual, operate the up-down louvers with a remote controller and check the up-down louvers is operating normally.