

Air Conditioning
Technical Data

ERQ-AW1



- > ERQ125A7W1B
- > ERQ200A7W1B
- > ERQ250A7W1B

TABLE OF CONTENTS

ERQ-AW1

1	Features	2
2	Specifications	3
	Technical Specifications	3
	Electrical Specifications	4
3	Options	6
4	Combination table	7
5	Capacity tables	8
	Cooling Capacity Tables	8
	Heating Capacity Tables	14
	Integrated Heating Capacity Correction Factor	20
	Capacity Correction Factor	21
6	Dimensional drawings	22
	Dimensional Drawings	22
	Dimensional Drawings with Accessories	23
7	Centre of gravity	24
8	Piping diagrams	26
9	Wiring diagrams	29
	Wiring Diagrams - Single Phase	29
10	External connection diagrams	32
11	Sound data	33
	Sound Power Spectrum	33
	Sound Pressure Spectrum	34
12	Installation	35
	Installation Method	35
	Fixation and Foundation of Units	36
13	Operation range	37

1 Features

- Benefit from the high efficiency and fast response to changing loads of ERQ condensing units
- Inverter controlled outdoor unit
- Predefined combinations with Daikin Modular air handling unit offer ready to use 'fresh air packages'
- R-410A heat pump

1



2 Specifications

2-1 Technical Specifications				ERQ125AW1	ERQ200AW1	ERQ250AW1	
Capacity range			HP	5	8	10	
Cooling capacity	Nom.		kW	14.0 (1)	22.4 (1)	28.0 (1)	
Heating capacity	Nom.		kW	16.0 (2)	25.0 (2)	31.5 (2)	
Power input	Cooling	Nom.	kW	3.52 (1)	5.22 (1)	7.42 (1)	
	Heating	Nom.	kW	4.00 (2)	5.56 (2)	7.70 (2)	
Capacity control	Method			Inverter controlled			
	Cooling	Max.	%	100			
EER				3.98 (1)	4.29 (1)	3.77 (1)	
COP				4.00 (2)	4.50 (2)	4.09 (2)	
Dimensions	Unit	Height	mm	1,680			
		Width	mm	635	930		
		Depth	mm	765			
	Packed unit	Height	mm	1,855			
		Width	mm	704	995		
		Depth	mm	860			
Weight	Unit		kg	159	187	240	
	Packed unit		kg	182	217	273	
Packing	Material			Carton			
	Weight			kg	3.8	4.02	
Packing 2	Material			Wood			
	Weight			kg	19.15	20.85	
Packing 3	Material			Plastic			
	Weight			kg	0.215	0.265	
Casing	Colour			Daikin White			
	Material			Painted galvanized steel plate			
Heat exchanger	Length		mm	1,483	1,778		
	Rows	Quantity		54			
	Fin pitch		mm	2			
	Passes	Quantity		8	18		
	Face area		m ²	1.762	2.112		
	Stages	Quantity		2			
	Empty tubeplate hole	Quantity		0			
	Tube type			ø8 Hi-XSS			
	Fin	Type			Non-symmetric waffle louver		
		Treatment			Hydrophilic and corrosion resistant		
	Compressor	Quantity			1		2
Model			Inverter				
Type			Hermetically sealed scroll compressor				
Speed		rpm		6,300	7,980	6,300	
Output		W		2,800	3,800	1,200	
Crankcase heater		W	33				
Compressor 2	Model			-			
	Type			-			
	Speed	rpm		-			
	Output	W		-			
	Crankcase heater		W	-			
Fan	Type			Propeller fan			
	Discharge direction			Vertical			
	Quantity			1			
	Air flow rate	Cooling	Nom.	m ³ /min	95	171	185
		Heating	Nom.	m ³ /min	95	171	185
	External static pressure	Max.		Pa	78		
Fan motor	Quantity			1			
	Model			Brushless DC motor			
	Output		W	350	750		
Sound power level	Nom.		dBA	72	78		

2 Specifications

2

2-1 Technical Specifications				ERQ125AW1	ERQ200AW1	ERQ250AW1	
Sound pressure level	Nom.			dBa	54	57	58
Operation range	Cooling	Min.		°CDB	-5		
		Max.		°CDB	43		
	Heating	Min.		°CWB	-20		
		Max.		°CWB	15		
	On coil temperature	Heating	Min.	°CDB	10		
Cooling		Max.	°CDB	35			
Refrigerant	Type			R-410A			
	Charge			kg	6.2	7.7	8.4
				TCO _{2eq}	12.9	16.1	17.5
	GWP			2,087.5			
	Control			Electronic expansion valve			
Circuits	Quantity			1			
Refrigerant oil	Type			Synthetic (ether) oil			
	Charged volume			l	1.7	2.1	4.3
Piping connections	Liquid	Type		Braze connection			
		OD	mm	9.52			
	Gas	Type		Braze connection			
		OD	mm	15.9	19.1	22.2	
	Piping length	OU - IU	Max.	m	55		
Heat insulation			Both liquid and gas pipes				
Defrost method				Reversed cycle			
Defrost control				Sensor for outdoor heat exchanger temperature			
Safety devices	Item	01		High pressure switch			
		02		Fan motor driver overload protector			
		03		Overcurrent relay			
		04		Inverter overload protector			
		05		PC board fuse			
PED	Category			Category II			

Standard Accessories : Installation manual; Quantity : 1;

Standard Accessories : Operation manual; Quantity : 1;

Standard Accessories : Connection pipes; Quantity : 4;

2-2 Electrical Specifications				ERQ125AW1	ERQ200AW1	ERQ250AW1	
Power supply	Name			W1			
	Phase			3N~			
	Frequency		Hz	50			
	Voltage		V	400			
	Voltage range	Min.		%			
Max.		%					
Current	Nominal running current (RLA)	Cooling	A	5.1	7.5	11.3	
		Heating	A	5.8	8.2	11.1	
	Starting current	Cooling	A	-		74 (1)	
	Zmax	Text	Ω	-	0.27		
	Minimum circuit amps (MCA)		A	11.9	18.5	21.6	
	Maximum fuse amps (MFA)		A	16	25		
	Total overcurrent amps (TOCA)		A	15.6	16.5	31.5	
	Full load amps (FLA)	Fan motor	A	0.4	0.7	0.9	
Minimum Ssc value		kVa	-	910	838		
Wiring connections	For power supply	Quantity		5			
		Remark		Earth wire included			
	For connection with indoor	Quantity		2			
		Remark		F1,F2			
Power supply intake				Both indoor and outdoor unit			

4

2 Specifications

Notes

(1) Cooling: indoor temp. 27°CDB, 19.0°CWB; outdoor temp. 35°CDB; equivalent piping length: 5m; level difference: 0m

(2) Heating: indoor temp. 20°CDB; outdoor temp. 7°CDB, 6°CWB; equivalent refrigerant piping: 5m; level difference: 0m

Sound values are measured in a semi-anechoic room.

Sound power level is an absolute value that a sound source generates.

Sound pressure level is a relative value, depending on the distance and acoustic environment. For more details, please refer to the sound level drawings.

MFA is used to select the circuit breaker and the ground fault circuit interrupter (earth leakage circuit breaker).

Maximum allowable voltage range variation between phases is 2%.

RLA is based on following conditions: indoor temp. 27°CDB, 19°CWB; outdoor temp. 35°CDB

Select wire size based on the value of MCA

TOCA means the total value of each OC set.

Voltage range: units are suitable for use on electrical systems where voltage supplied to unit terminal is not below or above listed range limits.

FLA means the full load amps of the fan motor.

In accordance with EN/IEC 61000-3-11, respectively EN/IEC 61000-3-12, it may be necessary to consult the distribution network operator to ensure that the equipment is connected only to a supply with $Z_{sys} \leq Z_{max}$, respectively $S_{sc} \geq \text{minimum } S_{sc} \text{ value}$.

EN/IEC 61000-3-11: European/international technical standard setting the limits for voltage changes, voltage fluctuations and flicker in public low-voltage supply systems for equipment with rated $\leq 75A$

EN/IEC 61000-3-12: European/international technical standard setting the limits for harmonic currents produced by equipment connected to public low-voltage system with input current $> 16A$ and $\leq 75A$ per phase

Short-circuit power

system impedance

Contains fluorinated greenhouse gases

MSC means the maximum current during start up of the compressor

3 Options

3 - 1 Options

3

ERQ-AW1			
N°	Item	ERQ125A7W1B	ERQ200A7W1B ERQ250A7W1B
1	Cool/heat selector	KRC19-26A6	
2	One option per module is required	KJB111A	
3	Central drain pan kit	KWC26B160	KWC26B280

4TW32031-4

Notes:

1. All options are kits.
2. Only 1 option per installation is needed.
3. One option per module is required
4. The option should be installed inside the outdoor unit.

4 Combination table

4 - 1 Combination Table

ERQ-AW1

Combination table

Outdoor unit		Control box			Expansion valve kit					
		EKEQDCBV3	EKEQFCBV3	EKEXV63	EKEXV80	EKEXV100	EKEXV125	EKEXV140	EKEXV200	EKEXV250
1 ph	ERQ100	P	P	P	P	P	P	-	-	-
	ERQ125	P	P	P	P	P	P	P	-	-
	ERQ140	P	P	-	P	P	P	P	-	-
3 ph	ERQ125	P	P	P	P	P	P	P	-	-
	ERQ200	P	P	-	-	P	P	P	P	P
	ERQ250	P	P	-	-	-	P	P	P	P

Heat pump

P: Pair: Combination depending on AHU heat exchanger volume and capacity

EKEXV Class	Allowed heat exchanger volume (dm ³)		Allowed heat exchanger capacity (kW)	
	Minimum	Maximum	Minimum	Maximum
63	1.66	2.08	6.3	7.8
80	2.09	2.64	7.9	9.9
100	2.65	3.3	10	12.3
125	3.31	4.12	12.4	15.4
140	4.13	4.62	15.5	17.6
200	4.63	6.6	17.7	24.6
250	6.61	8.25	24.7	30.8

Saturated suction temperature (SST) = 6°C, Superheat (SH) = 5K
Air temperature = 27°CDB/19°CWB

If conflicting result occurs, capacity selection has priority over volume.

3TW32009-1

5 Capacity tables

5 - 1 Cooling Capacity Tables

ERQ125AW1 Cooling

TC: Total capacity; kW; PI: Power Input; kW (Comp. + Outdoor fan motor)

Combination % kW (Capacity index)	Outdoor air temp. (°CDB)	Indoor air temp. °CWB														
		14.0 °CWB		16.0 °CWB		18.0 °CWB		19.0 °CWB		20.0 °CWB		22.0 °CWB		24.0 °CWB		
		20.0 °CDB		23.0 °CDB		26.0 °CDB		27.0 °CDB		28.0 °CDB		30.0 °CDB		32.0 °CDB		
		TC	PI	TC	PI	TC	PI	TC	PI	TC	PI	TC	PI	TC	PI	
100% 14.00 kW (125)	10	9.45	1.21	11.3	1.47	13.1	1.74	14.0	1.88	14.9	2.02	16.7	2.31	17.7	2.39	
	12	9.45	1.23	11.3	1.50	13.1	1.78	14.0	1.92	14.9	2.06	16.7	2.36	17.5	2.38	
	14	9.45	1.26	11.3	1.53	13.1	1.81	14.0	1.95	14.9	2.10	16.7	2.40	17.2	2.37	
	16	9.45	1.28	11.3	1.55	13.1	1.84	14.0	1.99	14.9	2.14	16.7	2.43	17.0	2.41	
	18	9.45	1.30	11.3	1.58	13.1	1.88	14.0	2.03	14.9	2.19	16.4	2.51	16.8	2.53	
	20	9.45	1.33	11.3	1.62	13.1	1.94	14.0	2.13	14.9	2.24	16.2	2.64	16.6	2.66	
	21	9.45	1.34	11.3	1.63	13.1	2.01	14.0	2.21	14.9	2.43	16.1	2.70	16.4	2.72	
	23	9.45	1.38	11.3	1.74	13.1	2.15	14.0	2.37	14.9	2.60	15.9	2.82	16.2	2.84	
	25	9.45	1.47	11.3	1.86	13.1	2.30	14.0	2.54	14.9	2.79	15.6	2.94	16.0	2.97	
	27	9.45	1.56	11.3	1.98	13.1	2.46	14.0	2.71	14.9	2.98	15.4	3.07	15.8	3.09	
	29	9.45	1.67	11.3	2.12	13.1	2.62	14.0	2.90	14.9	3.16	15.2	3.19	15.5	3.22	
	31	9.45	1.77	11.3	2.26	13.1	2.80	14.0	3.09	14.6	3.29	15.0	3.32	15.3	3.34	
	33	9.45	1.89	11.3	2.40	13.1	2.99	14.0	3.30	14.4	3.41	14.7	3.44	15.1	3.47	
	35	9.45	2.00	11.3	2.56	13.1	3.18	14.0	3.52	14.2	3.54	14.5	3.57	14.9	3.60	
	37	9.45	2.13	11.3	2.72	13.1	3.39	13.8	3.64	13.9	3.66	14.3	3.69	14.6	3.73	
	39	9.45	2.26	11.3	2.90	13.1	3.61	13.5	3.77	13.7	3.79	14.1	3.82	14.4	3.85	
	90% 12.60 kW (113)	10	8.50	1.09	10.1	1.31	11.8	1.55	12.6	1.67	13.4	1.79	15.1	2.05	16.7	2.31
		12	8.50	1.10	10.1	1.33	11.8	1.57	12.6	1.70	13.4	1.83	15.1	2.09	16.7	2.35
		14	8.50	1.12	10.1	1.36	11.8	1.60	12.6	1.73	13.4	1.86	15.1	2.13	16.7	2.40
16		8.50	1.14	10.1	1.38	11.8	1.63	12.6	1.76	13.4	1.90	15.1	2.17	16.7	2.44	
18		8.50	1.16	10.1	1.41	11.8	1.67	12.6	1.80	13.4	1.94	15.1	2.21	16.4	2.51	
20		8.50	1.18	10.1	1.44	11.8	1.70	12.6	1.84	13.4	2.01	15.1	2.28	16.2	2.63	
21		8.50	1.20	10.1	1.45	11.8	1.73	12.6	1.90	13.4	2.08	15.1	2.46	16.1	2.70	
23		8.50	1.22	10.1	1.51	11.8	1.85	12.6	2.03	13.4	2.23	15.1	2.64	15.9	2.82	
25		8.50	1.28	10.1	1.61	11.8	1.98	12.6	2.18	13.4	2.38	15.1	2.83	15.6	2.94	
27		8.50	1.37	10.1	1.72	11.8	2.11	12.6	2.32	13.4	2.55	15.1	3.03	15.4	3.07	
29		8.50	1.45	10.1	1.83	11.8	2.25	12.6	2.48	13.4	2.72	14.9	3.17	15.2	3.19	
31		8.50	1.55	10.1	1.95	11.8	2.40	12.6	2.65	13.4	2.90	14.7	3.29	15.0	3.31	
33		8.50	1.64	10.1	2.07	11.8	2.56	12.6	2.82	13.4	3.10	14.4	3.41	14.7	3.44	
35		8.50	1.74	10.1	2.21	11.8	2.73	12.6	3.01	13.4	3.30	14.2	3.54	14.5	3.57	
37		8.50	1.85	10.1	2.35	11.8	2.90	12.6	3.20	13.4	3.52	14.0	3.66	14.3	3.69	
39		8.50	1.96	10.1	2.49	11.8	3.09	12.6	3.41	13.4	3.75	13.7	3.79	14.0	3.82	
80% 11.20 kW (100)		10	7.56	0.96	9.02	1.15	10.5	1.36	11.2	1.46	11.9	1.57	13.4	1.79	14.8	2.01
		12	7.56	0.98	9.02	1.17	10.5	1.38	11.2	1.49	11.9	1.60	13.4	1.82	14.8	2.05
		14	7.56	1.00	9.02	1.19	10.5	1.41	11.2	1.51	11.9	1.63	13.4	1.86	14.8	2.09
	16	7.56	1.01	9.02	1.22	10.5	1.43	11.2	1.54	11.9	1.66	13.4	1.89	14.8	2.13	
	18	7.56	1.03	9.02	1.24	10.5	1.46	11.2	1.57	11.9	1.69	13.4	1.93	14.8	2.17	
	20	7.56	1.05	9.02	1.26	10.5	1.49	11.2	1.60	11.9	1.72	13.4	2.00	14.8	2.33	
	21	7.56	1.06	9.02	1.27	10.5	1.50	11.2	1.62	11.9	1.76	13.4	2.07	14.8	2.41	
	23	7.56	1.08	9.02	1.30	10.5	1.58	11.2	1.73	11.9	1.86	13.4	2.22	14.8	2.58	
	25	7.56	1.11	9.02	1.38	10.5	1.68	11.2	1.84	11.9	2.01	13.4	2.37	14.8	2.77	
	27	7.56	1.18	9.02	1.47	10.5	1.79	11.2	1.97	11.9	2.15	13.4	2.54	14.8	2.96	
	29	7.56	1.26	9.02	1.57	10.5	1.91	11.2	2.10	11.9	2.29	13.4	2.71	14.8	3.16	
	31	7.56	1.33	9.02	1.67	10.5	2.04	11.2	2.24	11.9	2.45	13.4	2.89	14.6	3.29	
	33	7.56	1.42	9.02	1.77	10.5	2.17	11.2	2.38	11.9	2.61	13.4	3.09	14.4	3.41	
	35	7.56	1.50	9.02	1.88	10.5	2.31	11.2	2.54	11.9	2.78	13.4	3.29	14.2	3.53	
	37	7.56	1.59	9.02	2.00	10.5	2.45	11.2	2.70	11.9	2.96	13.4	3.51	13.9	3.66	
	39	7.56	1.69	9.02	2.12	10.5	2.61	11.2	2.87	11.9	3.15	13.4	3.73	13.7	3.78	
	70% 9.80 kW (88)	10	6.61	0.85	7.89	1.01	9.16	1.17	9.80	1.26	10.4	1.35	11.7	1.54	13.0	1.73
		12	6.61	0.86	7.89	1.02	9.16	1.19	9.80	1.28	10.4	1.38	11.7	1.56	13.0	1.76
		14	6.61	0.87	7.89	1.04	9.16	1.22	9.80	1.31	10.4	1.40	11.7	1.59	13.0	1.79
16		6.61	0.89	7.89	1.06	9.16	1.24	9.80	1.33	10.4	1.43	11.7	1.62	13.0	1.83	
18		6.61	0.90	7.89	1.08	9.16	1.26	9.80	1.36	10.4	1.45	11.7	1.66	13.0	1.86	
20		6.61	0.92	7.89	1.10	9.16	1.28	9.80	1.38	10.4	1.48	11.7	1.69	13.0	1.92	
21		6.61	0.93	7.89	1.11	9.16	1.30	9.80	1.40	10.4	1.50	11.7	1.71	13.0	1.98	
23		6.61	0.94	7.89	1.13	9.16	1.32	9.80	1.44	10.4	1.57	11.7	1.84	13.0	2.12	
25		6.61	0.96	7.89	1.17	9.16	1.41	9.80	1.54	10.4	1.67	11.7	1.96	13.0	2.27	
27		6.61	1.01	7.89	1.25	9.16	1.50	9.80	1.64	10.4	1.79	11.7	2.09	13.0	2.43	
29		6.61	1.08	7.89	1.32	9.16	1.60	9.80	1.75	10.4	1.90	11.7	2.23	13.0	2.59	
31		6.61	1.14	7.89	1.41	9.16	1.70	9.80	1.86	10.4	2.03	11.7	2.38	13.0	2.77	
33		6.61	1.21	7.89	1.49	9.16	1.81	9.80	1.98	10.4	2.16	11.7	2.54	13.0	2.95	
35		6.61	1.28	7.89	1.58	9.16	1.92	9.80	2.11	10.4	2.30	11.7	2.70	13.0	3.14	
37		6.61	1.35	7.89	1.68	9.16	2.04	9.80	2.24	10.4	2.44	11.7	2.88	13.0	3.35	
39		6.61	1.43	7.89	1.78	9.16	2.17	9.80	2.38	10.4	2.60	11.7	3.06	13.0	3.57	

4TW32032-1

NOTES - ANMERKUNGEN - Σημειώσεις - NOTAS - REMARQUES - NOTE - OPMERKINGEN - примечания - NOTLAR

- The above table shows the average value of conditions which may occur.
Die obige Tabelle zeigt den Durchschnittswert der Bedingungen, die auftreten können.
Στον παραπάνω πίνακα αναγράφεται η μέση τιμή για συνθήκες που μπορεί να προκύψουν.
La tabla de arriba muestra el valor medio de condiciones que pueden ocurrir.
Le tableau ci-dessus donne la valeur moyenne pour des conditions qui peuvent survenir.
La tabella in alto mostra il valore delle condizioni medie che si possono riscontrare.
De tabel hierboven geeft de gemiddelde waarde aan van situaties die kunnen voorvallen.
Таблица расположенная выше показывает среднее значение условий, которые могут наступить.
Yukarıdaki tablo meydana gelebilecek koşulların ortalama değerini göstermektedir.

5 Capacity tables

5 - 1 Cooling Capacity Tables

ERQ125AW1 Cooling

TC: Total capacity; kW; PI: Power Input; kW (Comp. + Outdoor fan motor)

Combination % kW (Capacity index)	Outdoor air temp. (°CDB)	Indoor air temp. °CWB													
		14.0 °CWB 20.0 °CDB		16.0 °CWB 23.0 °CDB		18.0 °CWB 26.0 °CDB		19.0 °CWB 27.0 °CDB		20.0 °CWB 28.0 °CDB		22.0 °CWB 30.0 °CDB		24.0 °CWB 32.0 °CDB	
		TC	PI	TC	PI	TC	PI	TC	PI	TC	PI	TC	PI	TC	PI
60% 8.40 kW (75)	10	5.67	0.74	6.76	0.87	7.85	1.00	8.40	1.07	8.95	1.14	10.0	1.29	11.1	1.45
	12	5.67	0.75	6.76	0.88	7.85	1.02	8.40	1.09	8.95	1.16	10.0	1.32	11.1	1.48
	14	5.67	0.76	6.76	0.89	7.85	1.03	8.40	1.11	8.95	1.18	10.0	1.34	11.1	1.50
	16	5.67	0.77	6.76	0.91	7.85	1.05	8.40	1.13	8.95	1.21	10.0	1.37	11.1	1.53
	18	5.67	0.78	6.76	0.92	7.85	1.07	8.40	1.15	8.95	1.23	10.0	1.39	11.1	1.56
	20	5.67	0.79	6.76	0.94	7.85	1.09	8.40	1.17	8.95	1.25	10.0	1.42	11.1	1.59
	21	5.67	0.80	6.76	0.95	7.85	1.10	8.40	1.18	8.95	1.26	10.0	1.43	11.1	1.61
	23	5.67	0.81	6.76	0.96	7.85	1.12	8.40	1.20	8.95	1.29	10.0	1.49	11.1	1.71
	25	5.67	0.83	6.76	0.98	7.85	1.16	8.40	1.26	8.95	1.37	10.0	1.59	11.1	1.83
	27	5.67	0.86	6.76	1.04	7.85	1.24	8.40	1.35	8.95	1.46	10.0	1.70	11.1	1.95
	29	5.67	0.91	6.76	1.10	7.85	1.32	8.40	1.43	8.95	1.55	10.0	1.81	11.1	2.08
	31	5.67	0.96	6.76	1.17	7.85	1.40	8.40	1.52	8.95	1.65	10.0	1.92	11.1	2.22
	33	5.67	1.02	6.76	1.24	7.85	1.48	8.40	1.62	8.95	1.75	10.0	2.05	11.1	2.36
	35	5.67	1.08	6.76	1.31	7.85	1.58	8.40	1.72	8.95	1.86	10.0	2.18	11.1	2.51
37	5.67	1.14	6.76	1.39	7.85	1.67	8.40	1.82	8.95	1.98	10.0	2.31	11.1	2.67	
39	5.67	1.20	6.76	1.47	7.85	1.77	8.40	1.93	8.95	2.10	10.0	2.46	11.1	2.84	
50% 7.00 kW (63)	10	4.72	0.63	5.63	0.73	6.54	0.84	7.00	0.89	7.46	0.95	8.37	1.07	9.28	1.19
	12	4.72	0.64	5.63	0.74	6.54	0.85	7.00	0.91	7.46	0.97	8.37	1.09	9.28	1.21
	14	4.72	0.65	5.63	0.75	6.54	0.87	7.00	0.92	7.46	0.98	8.37	1.10	9.28	1.23
	16	4.72	0.66	5.63	0.77	6.54	0.88	7.00	0.94	7.46	1.00	8.37	1.12	9.28	1.25
	18	4.72	0.67	5.63	0.78	6.54	0.89	7.00	0.95	7.46	1.02	8.37	1.14	9.28	1.28
	20	4.72	0.68	5.63	0.79	6.54	0.91	7.00	0.97	7.46	1.03	8.37	1.16	9.28	1.30
	21	4.72	0.68	5.63	0.80	6.54	0.92	7.00	0.98	7.46	1.04	8.37	1.18	9.28	1.31
	23	4.72	0.69	5.63	0.81	6.54	0.93	7.00	1.00	7.46	1.06	8.37	1.20	9.28	1.34
	25	4.72	0.70	5.63	0.82	6.54	0.95	7.00	1.02	7.46	1.09	8.37	1.26	9.28	1.43
	27	4.72	0.71	5.63	0.85	6.54	1.00	7.00	1.08	7.46	1.16	8.37	1.34	9.28	1.53
	29	4.72	0.76	5.63	0.90	6.54	1.06	7.00	1.15	7.46	1.24	8.37	1.42	9.28	1.63
	31	4.72	0.80	5.63	0.96	6.54	1.13	7.00	1.22	7.46	1.31	8.37	1.51	9.28	1.73
	33	4.72	0.84	5.63	1.01	6.54	1.19	7.00	1.29	7.46	1.39	8.37	1.61	9.28	1.84
	35	4.72	0.89	5.63	1.07	6.54	1.26	7.00	1.37	7.46	1.48	8.37	1.71	9.28	1.95
37	4.72	0.94	5.63	1.13	6.54	1.34	7.00	1.45	7.46	1.57	8.37	1.81	9.28	2.08	
39	4.72	0.99	5.63	1.19	6.54	1.42	7.00	1.53	7.46	1.66	8.37	1.92	9.28	2.20	

5 Capacity tables

5 - 1 Cooling Capacity Tables

ERQ200AW1 Cooling

TC: Total capacity; kW; PI: Power Input; kW (Comp. + Outdoor fan motor)

Combination % kW (Capacity index)	Outdoor air temp. (°CDB)	Indoor air temp. °CWB																																																																																																																																																																																																																																																	
		14.0 °CWB		16.0 °CWB		18.0 °CWB		19.0 °CWB		20.0 °CWB		22.0 °CWB		24.0 °CWB																																																																																																																																																																																																																																					
		20.0 °CDB	TC	PI	23.0 °CDB	TC	PI	26.0 °CDB	TC	PI	27.0 °CDB	TC	PI	28.0 °CDB	TC	PI	30.0 °CDB	TC	PI	32.0 °CDB	TC	PI																																																																																																																																																																																																																													
100% 22.40 kW (200)	10	15.1	1.80	18.0	2.18	20.9	2.58	22.4	2.79	23.9	3.00	26.8	3.43	28.3	3.55	12	15.1	1.83	18.0	2.22	20.9	2.63	22.4	2.84	23.9	3.06	26.8	3.50	28.0	3.53	14	15.1	1.86	18.0	2.26	20.9	2.68	22.4	2.90	23.9	3.12	26.8	3.56	27.6	3.51	16	15.1	1.90	18.0	2.31	20.9	2.73	22.4	2.96	23.9	3.18	26.7	3.61	27.2	3.57	18	15.1	1.93	18.0	2.35	20.9	2.79	22.4	3.01	23.9	3.24	26.3	3.73	26.9	3.75	20	15.1	1.97	18.0	2.40	20.9	2.87	22.4	3.17	23.9	3.47	26.0	3.91	26.5	3.94	21	15.1	1.99	18.0	2.42	20.9	2.97	22.4	3.28	23.9	3.60	25.8	4.00	26.3	4.03	23	15.1	2.04	18.0	2.58	20.9	3.19	22.4	3.51	23.9	3.86	25.4	4.18	25.9	4.21	25	15.1	2.18	18.0	2.76	20.9	3.41	22.4	3.76	23.9	4.13	25.0	4.36	25.6	4.40	27	15.1	2.32	18.0	2.94	20.9	3.64	22.4	4.02	23.9	4.42	24.7	4.55	25.2	4.58	29	15.1	2.47	18.0	3.14	20.9	3.89	22.4	4.30	23.8	4.69	24.3	4.73	24.9	4.77	31	15.1	2.63	18.0	3.35	20.9	4.15	22.4	4.59	23.4	4.88	23.9	4.92	24.5	4.96	33	15.1	2.80	18.0	3.56	20.9	4.43	22.4	4.89	23.0	5.06	23.6	5.10	24.1	5.15	35	15.1	2.97	18.0	3.79	20.9	4.72	22.4	5.22	22.7	5.24	23.2	5.29	23.8	5.34	37	15.1	3.16	18.0	4.04	20.9	5.03	22.0	5.40	22.3	5.43	22.9	5.48	23.4	5.53	39	15.1	3.35	18.0	4.29	20.9	5.35	21.7	5.59	21.9	5.61	22.5	5.67	23.0	5.72			
	90% 20.16 kW (180)	10	13.6	1.61	16.2	1.94	18.8	2.29	20.2	2.47	21.5	2.66	24.1	3.04	26.7	3.42	12	13.6	1.64	16.2	1.98	18.8	2.33	20.2	2.52	21.5	2.71	24.1	3.09	26.7	3.49	14	13.6	1.67	16.2	2.01	18.8	2.38	20.2	2.57	21.5	2.76	24.1	3.15	26.7	3.55	16	13.6	1.69	16.2	2.05	18.8	2.42	20.2	2.62	21.5	2.81	24.1	3.22	26.7	3.61	18	13.6	1.73	16.2	2.09	18.8	2.47	20.2	2.67	21.5	2.87	24.1	3.28	26.3	3.73	20	13.6	1.76	16.2	2.13	18.8	2.52	20.2	2.72	21.5	2.98	24.1	3.52	25.9	3.91	21	13.6	1.77	16.2	2.15	18.8	2.56	20.2	2.82	21.5	3.08	24.1	3.65	25.8	4.00	23	13.6	1.81	16.2	2.24	18.8	2.74	20.2	3.02	21.5	3.30	24.1	3.65	25.4	4.18	25	13.6	1.90	16.2	2.39	18.8	2.93	20.2	3.23	21.5	3.53	24.1	4.19	25.0	4.36	27	13.6	2.03	16.2	2.55	18.8	3.13	20.2	3.45	21.5	3.78	24.1	4.49	24.7	4.55	29	13.6	2.16	16.2	2.72	18.8	3.34	20.2	3.68	21.5	4.04	23.8	4.70	24.3	4.73	31	13.6	2.29	16.2	2.89	18.8	3.56	20.2	3.93	21.5	4.31	23.4	4.88	23.9	4.92	33	13.6	2.44	16.2	3.08	18.8	3.80	20.2	4.19	21.5	4.59	23.1	5.06	23.6	5.10	35	13.6	2.59	16.2	3.27	18.8	4.04	20.2	4.46	21.5	4.90	22.7	5.25	23.2	5.29	37	13.6	2.74	16.2	3.48	18.8	4.30	20.2	4.75	21.5	5.22	22.4	5.43	22.8	5.48	39	13.6	2.91	16.2	3.70	18.8	4.58	20.2	5.06	21.5	5.56	22.0	5.62	22.5	5.66		
		80% 17.92 kW (160)	10	12.1	1.43	14.4	1.71	16.8	2.01	17.9	2.17	19.1	2.33	21.4	2.65	23.7	2.99	12	12.1	1.45	14.4	1.74	16.8	2.05	17.9	2.21	19.1	2.37	21.4	2.70	23.7	3.04	14	12.1	1.48	14.4	1.77	16.8	2.08	17.9	2.25	19.1	2.41	21.4	2.75	23.7	3.10	16	12.1	1.50	14.4	1.80	16.8	2.12	17.9	2.29	19.1	2.46	21.4	2.81	23.7	3.16	18	12.1	1.53	14.4	1.84	16.8	2.16	17.9	2.33	19.1	2.51	21.4	2.86	23.7	3.22	20	12.1	1.55	14.4	1.87	16.8	2.21	17.9	2.38	19.1	2.56	21.4	2.97	23.7	3.45	21	12.1	1.57	14.4	1.89	16.8	2.23	17.9	2.40	19.1	2.61	21.4	3.07	23.7	3.57	23	12.1	1.60	14.4	1.93	16.8	2.34	17.9	2.56	19.1	2.79	21.4	3.29	23.7	3.83	25	12.1	1.65	14.4	2.05	16.8	2.49	17.9	2.73	19.1	2.99	21.4	3.52	23.7	4.10	27	12.1	1.75	14.4	2.18	16.8	2.66	17.9	2.92	19.1	3.19	21.4	3.76	23.7	4.39	29	12.1	1.86	14.4	2.32	16.8	2.84	17.9	3.11	19.1	3.40	21.4	4.02	23.7	4.69	31	12.1	1.98	14.4	2.47	16.8	3.02	17.9	3.32	19.1	3.63	21.4	4.29	23.4	4.87	33	12.1	2.10	14.4	2.63	16.8	3.22	17.9	3.53	19.1	3.86	21.4	4.58	23.0	5.06	35	12.1	2.23	14.4	2.79	16.8	3.42	17.9	3.76	19.1	4.12	21.4	4.88	22.7	5.24	37	12.1	2.36	14.4	2.96	16.8	3.64	17.9	4.00	19.1	4.38	21.4	5.20	22.3	5.43	39	12.1	2.50	14.4	3.15	16.8	3.87	17.9	4.26	19.1	4.66	21.4	5.54	21.9	5.61	
			70% 15.68 kW (140)	10	10.6	1.26	12.6	1.49	14.7	1.74	15.7	1.87	16.7	2.00	18.7	2.28	20.8	2.56	12	10.6	1.28	12.6	1.52	14.7	1.77	15.7	1.90	16.7	2.04	18.7	2.32	20.8	2.61	14	10.6	1.30	12.6	1.54	14.7	1.80	15.7	1.94	16.7	2.08	18.7	2.36	20.8	2.66	16	10.6	1.32	12.6	1.57	14.7	1.83	15.7	1.97	16.7	2.12	18.7	2.41	20.8	2.71	18	10.6	1.34	12.6	1.60	14.7	1.87	15.7	2.01	16.7	2.16	18.7	2.45	20.8	2.76	20	10.6	1.36	12.6	1.62	14.7	1.90	15.7	2.05	16.7	2.20	18.7	2.50	20.8	2.84	21	10.6	1.37	12.6	1.64	14.7	1.92	15.7	2.07	16.7	2.22	18.7	2.54	20.8	2.94	23	10.6	1.40	12.6	1.67	14.7	1.96	15.7	2.14	16.7	2.33	18.7	2.72	20.8	3.15	25	10.6	1.42	12.6	1.74	14.7	2.09	15.7	2.28	16.7	2.48	18.7	2.91	20.8	3.37	27	10.6	1.50	12.6	1.85	14.7	2.23	15.7	2.43	16.7	2.65	18.7	3.11	20.8	3.60	29	10.6	1.59	12.6	1.96	14.7	2.37	15.7	2.59	16.7	2.82	18.7	3.31	20.8	3.85	31	10.6	1.69	12.6	2.09	14.7	2.52	15.7	2.76	16.7	3.01	18.7	3.53	20.8	4.10	33	10.6	1.79	12.6	2.21	14.7	2.68	15.7	2.94	16.7	3.20	18.7	3.76	20.8	4.38	35	10.6	1.90	12.6	2.35	14.7	2.85	15.7	3.12	16.7	3.40	18.7	4.01	20.8	4.66	37	10.6	2.01	12.6	2.49	14.7	3.03	15.7	3.32	16.7	3.62	18.7	4.27	20.8	4.97	39	10.6	2.13	12.6	2.64	14.7	3.22	15.7	3.52	16.7	3.85	18.7	4.54	20.8	5.29

4TW32032-1

NOTES - ANMERKUNGEN - Σημειώσεις - NOTAS - REMARQUES - NOTE - OPMERKINGEN - примечания - NOTLAR

- The above table shows the average value of conditions which may occur.
Die obige Tabelle zeigt den Durchschnittswert der Bedingungen, die auftreten können.
Στον παραπάνω πίνακα αναγράφεται η μέση τιμή για συνθήκες που μπορεί να προκύψουν.
La tabla de arriba muestra el valor medio de condiciones que pueden ocurrir.
Le tableau ci-dessus donne la valeur moyenne pour des conditions qui peuvent survenir.
La tabella in alto mostra il valore delle condizioni medie che si possono riscontrare.
De tabel hierboven geeft de gemiddelde waarde aan van situaties die kunnen voorvallen.
Таблица расположенная выше показывает среднее значение условий, которые могут наступить.
Yukarıdaki tablo meydana gelebilecek koşulların ortalama değerini göstermektedir.

5 Capacity tables

5 - 1 Cooling Capacity Tables

ERQ200AW1 Cooling

TC: Total capacity; kW; PI: Power Input; kW (Comp. + Outdoor fan motor)

Combination % kW (Capacity index)	Outdoor air temp. (°CDB)	Indoor air temp. °CWB														
		14.0 °CWB 20.0 °CDB		16.0 °CWB 23.0 °CDB		18.0 °CWB 26.0 °CDB		19.0 °CWB 27.0 °CDB		20.0 °CWB 28.0 °CDB		22.0 °CWB 30.0 °CDB		24.0 °CWB 32.0 °CDB		
		TC	PI	TC	PI	TC	PI	TC	PI	TC	PI	TC	PI	TC	PI	
60% 13.44 kW (120)	10	9.1	1.09	10.8	1.28	12.6	1.48	13.4	1.59	14.3	1.70	16.1	1.92	17.8	2.15	
	12	9.1	1.11	10.8	1.30	12.6	1.51	13.4	1.62	14.3	1.73	16.1	1.95	17.8	2.19	
	14	9.1	1.12	10.8	1.32	12.6	1.53	13.4	1.64	14.3	1.76	16.1	1.99	17.8	2.23	
	16	9.1	1.14	10.8	1.34	12.6	1.56	13.4	1.67	14.3	1.79	16.1	2.03	17.8	2.27	
	18	9.1	1.16	10.8	1.37	12.6	1.59	13.4	1.70	14.3	1.82	16.1	2.06	17.8	2.32	
	20	9.1	1.18	10.8	1.39	12.6	1.62	13.4	1.73	14.3	1.86	16.1	2.10	17.8	2.36	
	21	9.1	1.19	10.8	1.40	12.6	1.63	13.4	1.75	14.3	1.87	16.1	2.12	17.8	2.39	
	23	9.1	1.21	10.8	1.43	12.6	1.66	13.4	1.78	14.3	1.91	16.1	2.17	17.8	2.54	
	25	9.1	1.23	10.8	1.45	12.6	1.73	13.4	1.87	14.3	2.03	16.1	2.36	17.8	2.71	
	27	9.1	1.27	10.8	1.54	12.6	1.84	13.4	2.00	14.3	2.16	16.1	2.51	17.8	2.89	
	29	9.1	1.35	10.8	1.63	12.6	1.95	13.4	2.12	14.3	2.30	16.1	2.68	17.8	3.09	
	31	9.1	1.43	10.8	1.73	12.6	2.07	13.4	2.26	14.3	2.45	16.1	2.85	17.8	3.29	
	33	9.1	1.51	10.8	1.84	12.6	2.20	13.4	2.40	14.3	2.60	16.1	3.03	17.8	3.50	
	35	9.1	1.59	10.8	1.95	12.6	2.34	13.4	2.54	14.3	2.76	16.1	3.23	17.8	3.73	
	37	9.1	1.69	10.8	2.06	12.6	2.48	13.4	2.70	14.3	2.93	16.1	3.43	17.8	3.97	
	39	9.1	1.78	10.8	2.18	12.6	2.63	13.4	2.86	14.3	3.11	16.1	3.64	17.8	4.22	
	50% 11.20 kW (100)	10	7.56	0.94	9.0	1.09	10.5	1.24	11.2	1.33	11.9	1.41	13.4	1.58	14.8	1.76
		12	7.56	0.95	9.0	1.10	10.5	1.26	11.2	1.35	11.9	1.43	13.4	1.61	14.8	1.79
		14	7.56	0.96	9.0	1.12	10.5	1.28	11.2	1.37	11.9	1.46	13.4	1.64	14.8	1.83
16		7.56	0.98	9.0	1.14	10.5	1.30	11.2	1.39	11.9	1.48	13.4	1.67	14.8	1.86	
18		7.56	0.99	9.0	1.15	10.5	1.32	11.2	1.41	11.9	1.51	13.4	1.70	14.8	1.89	
20		7.56	1.01	9.0	1.17	10.5	1.35	11.2	1.44	11.9	1.53	13.4	1.73	14.8	1.93	
21		7.56	1.01	9.0	1.18	10.5	1.36	11.2	1.45	11.9	1.55	13.4	1.74	14.8	1.95	
23		7.56	1.03	9.0	1.20	10.5	1.38	11.2	1.48	11.9	1.57	13.4	1.78	14.8	1.99	
25		7.56	1.04	9.0	1.22	10.5	1.41	11.2	1.51	11.9	1.62	13.4	1.87	14.8	2.13	
27		7.56	1.06	9.0	1.26	10.5	1.48	11.2	1.60	11.9	1.73	13.4	1.99	14.8	2.27	
29		7.56	1.12	9.0	1.34	10.5	1.58	11.2	1.70	11.9	1.83	13.4	2.11	14.8	2.41	
31		7.56	1.18	9.0	1.42	10.5	1.67	11.2	1.81	11.9	1.95	13.4	2.25	14.8	2.57	
33		7.56	1.25	9.0	1.50	10.5	1.77	11.2	1.91	11.9	2.07	13.4	2.38	14.8	2.73	
35		7.56	1.32	9.0	1.58	10.5	1.87	11.2	2.03	11.9	2.19	13.4	2.53	14.8	2.90	
37		7.56	1.39	9.0	1.67	10.5	1.98	11.2	2.15	11.9	2.32	13.4	2.69	14.8	3.08	
39		7.56	1.47	9.0	1.77	10.5	2.10	11.2	2.28	11.9	2.46	13.4	2.85	14.8	3.27	

5 Capacity tables

5 - 1 Cooling Capacity Tables

ERQ250AW1 Cooling

TC: Total capacity; kW; PI: Power Input; kW (Comp. + Outdoor fan motor)

Combination % kW (Capacity index)	Outdoor air temp. (°CDB)	Indoor air temp. °CWB															
		14.0 °CWB		16.0 °CWB		18.0 °CWB		19.0 °CWB		20.0 °CWB		22.0 °CWB		24.0 °CWB			
		TC	PI	TC	PI	TC	PI	TC	PI	TC	PI	TC	PI	TC	PI		
100% 28.00 kW (250)	10	18.9	2.56	22.5	3.10	26.2	3.67	28.0	3.97	29.8	4.27	33.5	4.88	35.4	5.05		
	12	18.9	2.60	22.5	3.16	26.2	3.74	28.0	4.04	29.8	4.35	33.5	4.97	34.9	5.02		
	14	18.9	2.65	22.5	3.22	26.2	3.81	28.0	4.12	29.8	4.43	33.5	5.07	34.5	4.99		
	16	18.9	2.70	22.5	3.28	26.2	3.89	28.0	4.20	29.8	4.52	33.3	5.13	34.0	5.08		
	18	18.9	2.75	22.5	3.34	26.2	3.96	28.0	4.28	29.8	4.61	32.9	5.20	33.6	5.34		
	20	18.9	2.80	22.5	3.41	26.2	4.03	28.0	4.36	29.8	4.70	32.4	5.27	33.1	5.60		
	21	18.9	2.83	22.5	3.44	26.2	4.07	28.0	4.40	29.8	4.74	32.2	5.31	32.9	5.73		
	23	18.9	2.90	22.5	3.51	26.2	4.15	28.0	4.49	29.8	4.83	31.8	5.39	32.4	5.99		
	25	18.9	3.09	22.5	3.69	26.2	4.33	28.0	4.67	29.8	5.01	31.3	5.47	32.0	6.25		
	27	18.9	3.30	22.5	3.90	26.2	4.54	28.0	4.88	29.8	5.22	30.8	5.56	31.5	6.52		
90% 25.20 kW (225)	10	17.0	2.29	20.3	2.76	23.6	3.26	25.2	3.52	26.8	3.78	30.1	4.32	33.4	4.87		
	12	17.0	2.33	20.3	2.81	23.6	3.32	25.2	3.58	26.8	3.85	30.1	4.40	33.4	4.96		
	14	17.0	2.37	20.3	2.86	23.6	3.38	25.2	3.65	26.8	3.92	30.1	4.48	33.4	5.05		
	16	17.0	2.41	20.3	2.91	23.6	3.45	25.2	3.72	26.8	4.00	30.1	4.57	33.3	5.14		
	18	17.0	2.45	20.3	2.97	23.6	3.51	25.2	3.79	26.8	4.08	30.1	4.66	32.9	5.30		
	20	17.0	2.50	20.3	3.03	23.6	3.58	25.2	3.87	26.8	4.17	30.1	4.75	32.4	5.55		
	21	17.0	2.52	20.3	3.06	23.6	3.64	25.2	3.90	26.8	4.20	30.1	4.79	32.2	5.68		
	23	17.0	2.57	20.3	3.12	23.6	3.70	25.2	3.97	26.8	4.29	30.1	4.88	31.7	5.94		
	25	17.0	2.71	20.3	3.40	23.6	4.17	25.2	4.29	26.8	4.61	30.1	5.19	31.3	6.20		
	27	17.0	2.88	20.3	3.62	23.6	4.45	25.2	4.59	26.8	4.90	30.1	5.57	30.8	6.46		
80% 22.40 kW (200)	10	15.1	2.03	18.0	2.43	20.9	2.86	22.4	3.08	23.9	3.30	26.8	3.77	29.7	4.25		
	12	15.1	2.06	18.0	2.47	20.9	2.91	22.4	3.14	23.9	3.37	26.8	3.84	29.7	4.33		
	14	15.1	2.10	18.0	2.52	20.9	2.96	22.4	3.19	23.9	3.43	26.8	3.91	29.7	4.41		
	16	15.1	2.13	18.0	2.56	20.9	3.02	22.4	3.25	23.9	3.49	26.8	3.99	29.7	4.49		
	18	15.1	2.17	18.0	2.61	20.9	3.08	22.4	3.32	23.9	3.56	26.8	4.07	29.7	4.58		
	20	15.1	2.21	18.0	2.66	20.9	3.14	22.4	3.38	23.9	3.63	26.8	4.15	29.7	4.66		
	21	15.1	2.23	18.0	2.68	20.9	3.17	22.4	3.42	23.9	3.67	26.8	4.19	29.7	4.74		
	23	15.1	2.27	18.0	2.74	20.9	3.22	22.4	3.48	23.9	3.74	26.8	4.27	29.7	4.82		
	25	15.1	2.34	18.0	2.91	20.9	3.55	22.4	3.89	23.9	4.24	26.8	5.01	29.7	5.45		
	27	15.1	2.49	18.0	3.10	20.9	3.78	22.4	4.15	23.9	4.53	26.8	5.35	29.7	6.24		
70% 19.60 kW (175)	10	13.2	1.79	15.8	2.12	18.3	2.47	19.6	2.66	20.9	2.85	23.4	3.24	26.0	3.64		
	12	13.2	1.81	15.8	2.15	18.3	2.52	19.6	2.71	20.9	2.90	23.4	3.30	26.0	3.71		
	14	13.2	1.84	15.8	2.19	18.3	2.56	19.6	2.75	20.9	2.95	23.4	3.36	26.0	3.78		
	16	13.2	1.87	15.8	2.23	18.3	2.61	19.6	2.81	20.9	3.01	23.4	3.42	26.0	3.85		
	18	13.2	1.90	15.8	2.27	18.3	2.66	19.6	2.86	20.9	3.06	23.4	3.49	26.0	3.93		
	20	13.2	1.93	15.8	2.31	18.3	2.71	19.6	2.91	20.9	3.12	23.4	3.56	26.0	4.04		
	21	13.2	1.95	15.8	2.33	18.3	2.73	19.6	2.94	20.9	3.15	23.4	3.61	26.0	4.18		
	23	13.2	1.98	15.8	2.37	18.3	2.79	19.6	3.04	20.9	3.23	23.4	3.69	26.0	4.48		
	25	13.2	2.02	15.8	2.47	18.3	2.97	19.6	3.25	20.9	3.53	23.4	4.14	26.0	4.79		
	27	13.2	2.14	15.8	2.63	18.3	3.17	19.6	3.46	20.9	3.77	23.4	4.42	26.0	5.12		
50% 12.80 kW (112)	10	11.3	1.52	13.5	1.81	15.8	2.01	16.8	2.16	18.0	2.31	20.1	2.56	22.4	2.81		
	12	11.3	1.54	13.5	1.84	15.8	2.04	16.8	2.19	18.0	2.34	20.1	2.59	22.4	2.84		
	14	11.3	1.56	13.5	1.87	15.8	2.07	16.8	2.22	18.0	2.37	20.1	2.62	22.4	2.87		
	16	11.3	1.58	13.5	1.90	15.8	2.10	16.8	2.25	18.0	2.40	20.1	2.65	22.4	2.90		
	18	11.3	1.60	13.5	1.93	15.8	2.13	16.8	2.28	18.0	2.43	20.1	2.68	22.4	2.93		
	20	11.3	1.62	13.5	1.96	15.8	2.16	16.8	2.31	18.0	2.46	20.1	2.71	22.4	2.96		
	21	11.3	1.63	13.5	1.97	15.8	2.17	16.8	2.32	18.0	2.47	20.1	2.72	22.4	2.97		
	23	11.3	1.65	13.5	1.99	15.8	2.19	16.8	2.34	18.0	2.49	20.1	2.74	22.4	2.99		
	25	11.3	1.67	13.5	2.01	15.8	2.21	16.8	2.36	18.0	2.51	20.1	2.76	22.4	3.01		
	27	11.3	1.69	13.5	2.03	15.8	2.23	16.8	2.38	18.0	2.53	20.1	2.78	22.4	3.03		

4TW32032-1

NOTES - ANMERKUNGEN - Σημειώσεις - NOTAS - REMARQUES - NOTE - OPMERKINGEN - примечания - NOTLAR

- The above table shows the average value of conditions which may occur.
 Die obige Tabelle zeigt den Durchschnittswert der Bedingungen, die auftreten können.
 Στον παραπάνω πίνακα αναγράφεται η μέση τιμή για συνθήκες που μπορεί να προκύψουν.
 La tabla de arriba muestra el valor medio de condiciones que pueden ocurrir.
 Le tableau ci-dessus donne la valeur moyenne pour des conditions qui peuvent survenir.
 La tabella in alto mostra il valore delle condizioni medie che si possono riscontrare.
 De tabel hierboven geeft de gemiddelde waarde aan van situaties die kunnen voorvallen.
 Таблица расположенная выше показывает среднее значение условий, которые могут наступить.
 Yukarıdaki tablo meydana gelebilecek koşulların ortalama değerini göstermektedir.

5 Capacity tables

5 - 1 Cooling Capacity Tables

ERQ250AW1 Cooling

TC: Total capacity; kW; PI: Power Input; kW (Comp. + Outdoor fan motor)

Combination % kW (Capacity index)	Outdoor air temp. (°CDB)	Indoor air temp. °CWB														
		14.0 °CWB 20.0 °CDB		16.0 °CWB 23.0 °CDB		18.0 °CWB 26.0 °CDB		19.0 °CWB 27.0 °CDB		20.0 °CWB 28.0 °CDB		22.0 °CWB 30.0 °CDB		24.0 °CWB 32.0 °CDB		
		TC	PI	TC	PI	TC	PI	TC	PI	TC	PI	TC	PI	TC	PI	
60% 16.80 kW (150)	10	11.3	1.55	13.5	1.82	15.7	2.11	16.8	2.26	17.9	2.41	20.1	2.73	22.3	3.06	
	12	11.3	1.58	13.5	1.85	15.7	2.15	16.8	2.30	17.9	2.45	20.1	2.78	22.3	3.11	
	14	11.3	1.60	13.5	1.88	15.7	2.18	16.8	2.34	17.9	2.50	20.1	2.83	22.3	3.17	
	16	11.3	1.62	13.5	1.91	15.7	2.22	16.8	2.38	17.9	2.54	20.1	2.88	22.3	3.23	
	18	11.3	1.65	13.5	1.94	15.7	2.26	16.8	2.42	17.9	2.59	20.1	2.93	22.3	3.29	
	20	11.3	1.67	13.5	1.98	15.7	2.30	16.8	2.47	17.9	2.64	20.1	2.99	22.3	3.36	
	21	11.3	1.69	13.5	1.99	15.7	2.32	16.8	2.49	17.9	2.66	20.1	3.02	22.3	3.39	
	23	11.3	1.71	13.5	2.03	15.7	2.36	16.8	2.54	17.9	2.71	20.1	3.14	22.3	3.61	
	25	11.3	1.74	13.5	2.06	15.7	2.45	16.8	2.66	17.9	2.88	20.1	3.35	22.3	3.85	
	27	11.3	1.81	13.5	2.19	15.7	2.61	16.8	2.84	17.9	3.07	20.1	3.57	22.3	4.11	
	29	11.3	1.91	13.5	2.32	15.7	2.78	16.8	3.02	17.9	3.27	20.1	3.81	22.3	4.39	
	31	11.3	2.03	13.5	2.46	15.7	2.95	16.8	3.21	17.9	3.48	20.1	4.05	22.3	4.67	
	33	11.3	2.14	13.5	2.61	15.7	3.13	16.8	3.41	17.9	3.70	20.1	4.31	22.3	4.98	
	35	11.3	2.27	13.5	2.77	15.7	3.32	16.8	3.62	17.9	3.93	20.1	4.59	22.3	5.30	
	37	11.3	2.40	13.5	2.93	15.7	3.52	16.8	3.84	17.9	4.17	20.1	4.88	22.3	5.64	
	39	11.3	2.53	13.5	3.10	15.7	3.73	16.8	4.07	17.9	4.43	20.1	5.18	22.3	6.00	
	50% 14.00 kW (125)	10	9.45	1.34	11.3	1.55	13.1	1.77	14.0	1.89	14.9	2.00	16.7	2.25	18.6	2.51
		12	9.45	1.35	11.3	1.57	13.1	1.80	14.0	1.91	14.9	2.04	16.7	2.29	18.6	2.55
		14	9.45	1.37	11.3	1.59	13.1	1.82	14.0	1.95	14.9	2.07	16.7	2.33	18.6	2.60
16		9.45	1.39	11.3	1.61	13.1	1.85	14.0	1.98	14.9	2.10	16.7	2.37	18.6	2.64	
18		9.45	1.41	11.3	1.64	13.1	1.88	14.0	2.01	14.9	2.14	16.7	2.41	18.6	2.69	
20		9.45	1.43	11.3	1.66	13.1	1.91	14.0	2.04	14.9	2.18	16.7	2.45	18.6	2.74	
21		9.45	1.44	11.3	1.68	13.1	1.93	14.0	2.06	14.9	2.20	16.7	2.48	18.6	2.77	
23		9.45	1.46	11.3	1.70	13.1	1.96	14.0	2.10	14.9	2.24	16.7	2.52	18.6	2.83	
25		9.45	1.48	11.3	1.73	13.1	2.00	14.0	2.14	14.9	2.31	16.7	2.65	18.6	3.02	
27		9.45	1.51	11.3	1.80	13.1	2.11	14.0	2.28	14.9	2.45	16.7	2.82	18.6	3.22	
29		9.45	1.59	11.3	1.90	13.1	2.24	14.0	2.42	14.9	2.61	16.7	3.00	18.6	3.43	
31		9.45	1.68	11.3	2.01	13.1	2.37	14.0	2.57	14.9	2.77	16.7	3.19	18.6	3.65	
33		9.45	1.78	11.3	2.13	13.1	2.52	14.0	2.72	14.9	2.94	16.7	3.39	18.6	3.88	
35		9.45	1.88	11.3	2.25	13.1	2.66	14.0	2.88	14.9	3.11	16.7	3.60	18.6	4.12	
37		9.45	1.98	11.3	2.38	13.1	2.82	14.0	3.05	14.9	3.30	16.7	3.82	18.6	4.38	
39		9.45	2.09	11.3	2.51	13.1	2.98	14.0	3.23	14.9	3.50	16.7	4.05	18.6	4.65	

5 Capacity tables

5 - 2 Heating Capacity Tables

ERQ125AW1

Heating

TC: Total capacity; kW; PI: Power Input; kW (Comp. + Outdoor fan motor)

Combination % kW (Capacity index)	Outdoor air temp.		Indoor air temp. °CWB											
			16.0		18.0		20.0		21.0		22.0		24.0	
			TC	PI	TC	PI	TC	PI	TC	PI	TC	PI	TC	PI
100% 14.00 kW (125)	-19.8	-20.0	10.4	3.61	10.4	3.76	10.4	3.91	10.3	3.98	10.3	4.06	10.3	4.20
	-18.8	-19.0	10.7	3.69	10.7	3.84	10.7	3.98	10.7	4.05	10.6	4.12	10.6	4.27
	-16.7	-17.0	11.3	3.84	11.3	3.98	11.3	4.11	11.3	4.18	11.3	4.25	11.2	4.38
	-13.7	-15.0	12.0	3.97	11.9	4.10	11.9	4.23	11.9	4.29	11.9	4.36	11.9	4.49
	-11.8	-13.0	12.6	4.09	12.6	4.21	12.5	4.34	12.5	4.40	12.5	4.46	12.5	4.58
	-9.8	-11.0	13.2	4.20	13.2	4.32	13.2	4.43	13.2	4.49	13.1	4.55	13.1	4.66
	-9.5	-10.0	13.5	4.25	13.5	4.36	13.5	4.48	13.5	4.53	13.5	4.59	13.4	4.70
	-8.5	-9.1	13.8	4.30	13.8	4.41	13.8	4.52	13.7	4.57	13.7	4.63	13.7	4.74
	-7.0	-7.6	14.3	4.36	14.3	4.47	14.2	4.58	14.2	4.63	14.2	4.68	13.9	4.67
	-5.0	-5.6	14.9	4.45	14.9	4.55	14.9	4.65	14.8	4.70	14.8	4.76	13.9	4.42
	-3.0	-3.7	15.5	4.52	15.5	4.62	15.5	4.72	15.4	4.77	15.0	4.60	13.9	4.21
	0.0	-0.7	16.4	4.63	16.4	4.72	16.0	4.63	15.5	4.45	15.0	4.27	13.9	3.92
	3.0	2.2	17.4	4.72	17.0	4.68	16.0	4.34	15.5	4.17	15.0	4.00	13.9	3.68
	5.0	4.1	18.0	4.78	17.0	4.49	16.0	4.16	15.5	4.00	15.0	3.84	13.9	3.54
	7.0	6.0	18.1	4.63	17.0	4.31	16.0	4.00	15.5	3.85	15.0	3.70	13.9	3.40
9.0	7.9	18.1	4.45	17.0	4.15	16.0	3.85	15.5	3.71	15.0	3.56	13.9	3.28	
11.0	9.8	18.1	4.29	17.0	4.00	16.0	3.71	15.5	3.57	15.0	3.44	13.9	3.17	
13.0	11.8	18.1	4.13	17.0	3.85	16.0	3.58	15.5	3.45	15.0	3.32	13.9	3.06	
15.0	13.7	18.1	3.99	17.0	3.72	16.0	3.46	15.5	3.33	15.0	3.21	13.9	2.96	
90% 12.60 kW (113)	-19.8	-20.0	10.4	3.87	10.3	4.00	10.3	4.14	10.3	4.20	10.3	4.27	10.3	4.40
	-18.8	-19.0	10.7	3.94	10.6	4.07	10.6	4.20	10.6	4.27	10.6	4.33	10.6	4.46
	-16.7	-17.0	11.3	4.08	11.3	4.20	11.2	4.32	11.2	4.38	11.2	4.44	11.2	4.57
	-13.7	-15.0	11.9	4.20	11.9	4.31	11.9	4.43	11.9	4.49	11.8	4.54	11.8	4.66
	-11.8	-13.0	12.6	4.31	12.5	4.42	12.5	4.53	12.5	4.58	12.5	4.63	12.4	4.74
	-9.8	-11.0	13.2	4.40	13.2	4.51	13.1	4.61	13.1	4.66	13.1	4.72	12.5	4.52
	-9.5	-10.0	13.5	4.45	13.5	4.55	13.4	4.65	13.4	4.70	13.4	4.75	12.5	4.39
	-8.5	-9.1	13.8	4.49	13.7	4.59	13.7	4.69	13.7	4.74	13.5	4.67	12.5	4.28
	-7.0	-7.6	14.2	4.55	14.2	4.65	14.2	4.74	13.9	4.66	13.5	4.47	12.5	4.10
	-5.0	-5.6	14.9	4.63	14.8	4.72	14.4	4.60	13.9	4.42	13.5	4.24	12.5	3.90
	-3.0	-3.7	15.5	4.70	15.3	4.73	14.4	4.38	13.9	4.21	13.5	4.04	12.5	3.72
	0.0	-0.7	16.3	4.72	15.3	4.40	14.4	4.08	13.9	3.92	13.5	3.77	12.5	3.47
	3.0	2.2	16.3	4.42	15.3	4.12	14.4	3.82	13.9	3.68	13.5	3.53	12.5	3.26
	5.0	4.1	16.3	4.24	15.3	3.95	14.4	3.67	13.9	3.53	13.5	3.40	12.5	3.13
	7.0	6.0	16.3	4.07	15.3	3.80	14.4	3.53	13.9	3.40	13.5	3.27	12.5	3.02
9.0	7.9	16.3	3.92	15.3	3.66	14.4	3.40	13.9	3.28	13.5	3.16	12.5	2.91	
11.0	9.8	16.3	3.78	15.3	3.53	14.4	3.29	13.9	3.17	13.5	3.05	12.5	2.82	
13.0	11.8	16.3	3.65	15.3	3.41	14.4	3.17	13.9	3.06	13.5	2.94	12.5	2.72	
15.0	13.7	16.3	3.52	15.3	3.29	14.4	3.07	13.9	2.96	13.5	2.85	12.5	2.64	
80% 11.20 kW (100)	-19.8	-20.0	10.3	4.13	10.3	4.25	10.3	4.37	10.3	4.43	10.2	4.49	10.2	4.60
	-18.8	-19.0	10.6	4.20	10.6	4.31	10.6	4.43	10.6	4.48	10.6	4.54	10.5	4.66
	-16.7	-17.0	11.2	4.32	11.2	4.42	11.2	4.53	11.2	4.59	11.2	4.64	11.2	4.75
	-13.7	-15.0	11.9	4.42	11.9	4.53	11.8	4.63	11.8	4.68	11.8	4.73	11.2	4.43
	-11.8	-13.0	12.5	4.52	12.5	4.62	12.5	4.71	12.4	4.73	12.0	4.54	11.2	4.16
	-9.8	-11.0	13.1	4.61	13.1	4.70	12.8	4.63	12.4	4.45	12.0	4.27	11.2	3.92
	-9.5	-10.0	13.4	4.65	13.4	4.74	12.8	4.50	12.4	4.32	12.0	4.15	11.2	3.81
	-8.5	-9.1	13.7	4.68	13.6	4.73	12.8	4.38	12.4	4.21	12.0	4.04	11.2	3.72
	-7.0	-7.6	14.2	4.74	13.6	4.53	12.8	4.20	12.4	4.04	12.0	3.88	11.2	3.57
	-5.0	-5.6	14.4	4.62	13.6	4.30	12.8	3.99	12.4	3.84	12.0	3.69	11.2	3.39
	-3.0	-3.7	14.4	4.40	13.6	4.10	12.8	3.80	12.4	3.66	12.0	3.52	11.2	3.24
	0.0	-0.7	14.4	4.09	13.6	3.82	12.8	3.55	12.4	3.41	12.0	3.28	11.2	3.03
	3.0	2.2	14.4	3.84	13.6	3.58	12.8	3.33	12.4	3.21	12.0	3.09	11.2	2.85
	5.0	4.1	14.4	3.68	13.6	3.44	12.8	3.20	12.4	3.09	12.0	2.97	11.2	2.75
	7.0	6.0	14.4	3.55	13.6	3.31	12.8	3.09	12.4	2.97	12.0	2.86	11.2	2.65
9.0	7.9	14.4	3.42	13.6	3.19	12.8	2.98	12.4	2.87	12.0	2.77	11.2	2.56	
11.0	9.8	14.4	3.30	13.6	3.09	12.8	2.88	12.4	2.78	12.0	2.67	11.2	2.48	
13.0	11.8	14.4	3.18	13.6	2.98	12.8	2.78	12.4	2.68	12.0	2.59	11.2	2.40	
15.0	13.7	14.4	3.08	13.6	2.88	12.8	2.69	12.4	2.60	12.0	2.51	11.2	2.32	

4TW32032-2

NOTES - ANMERKUNGEN - Σημειώσεις - NOTAS - REMARQUES - NOTE - OPMERKINGEN - примечания - NOTLAR

- is shown as reference
 - When selecting the unit models, avoid the outdoor air temperature range shown by ■
 - dient als Verweis.
 - Vermeiden Sie bei der Auswahl der Gerätemodelle den als ■ markierten Temperaturbereich der Außenluft.
 - εμφανίζεται σαν τιμή αναφοράς.
 - Κατά την επιλογή μοντέλων μονάδων, αποφύγετε την περιοχή θερμοκρασίας εξωτερικού αέρα που εμφανίζεται στο. ■
 - se muestra a modo de referencia.
 - Cuando seleccione los modelos de unidad, evite el intervalo de temperaturas del aire exterior indicado mediante ■
 - est indiqué à titre de référence.
 - Lors de la sélection des modèles d'unité, évitez la plage de température d'air extérieur repérée par ■
 - viene mostrato come riferimento.
 - Nel selezionare i modelli delle unità, non considerare i valori di temperatura dell'aria esterna indicati con il colore ■
 - wordt ter referentie opgegeven
 - Bij selectie van de modellen dient u het gemarkeerde ■ bereik voor de buitenluchttemperatuur te vermijden.
 - приведено для справки
 - При выборе моделей блоков избегайте диапазон температура наружного воздуха, показанный в ■
 - referans olarak görülmektedir.
 - Ünite modellerini seçerken, görülen dış hava sıcaklığı aralığından kaçınınız ■
- The above table shows the average value of conditions which may occur.
 - Die obige Tabelle zeigt den Durchschnittswert der Bedingungen, die auftreten können.
 - Στον παραπάνω πίνακα αναγράφεται η μέση τιμή για συνθήκες που μπορεί να προκύψουν.
 - La tabla de arriba muestra el valor medio de condiciones que pueden ocurrir.
 - Le tableau ci-dessus donne la valeur moyenne pour des conditions qui peuvent survenir.
 - La tabella in alto mostra il valore delle condizioni medie che si possono riscontrare.
 - De tabel hierboven geeft de gemiddelde waarde aan van situaties die kunnen voorvallen.
 - Таблица расположенная выше показывает среднее значение условий, которые могут наступить.
 - Yukarıdaki tablo meydana gelebilecek koşulların ortalama değerini göstermektedir.

5 Capacity tables

5 - 2 Heating Capacity Tables

ERQ125AW1

Heating

TC: Total capacity; kW; PI: Power Input; kW (Comp. + Outdoor fan motor)

Combination % kW (Capacity index)	Outdoor air temp.		Indoor air temp. °CWB											
			16.0		18.0		20.0		21.0		22.0		24.0	
			TC	PI	TC	PI	TC	PI	TC	PI	TC	PI	TC	PI
	°CDB	°CWB												
70% 9.80 kW (88)	-19.8	-20.0	10.3	4.39	10.2	4.49	10.2	4.60	10.2	4.65	10.2	4.70	9.8	4.50
	-18.8	-19.0	10.6	4.45	10.6	4.55	10.5	4.65	10.5	4.70	10.5	4.73	9.8	4.33
	-16.7	-17.0	11.2	4.55	11.2	4.65	11.2	4.74	10.8	4.58	10.5	4.40	9.8	4.03
	-13.7	-15.0	11.8	4.65	11.8	4.74	11.2	4.46	10.8	4.28	10.5	4.11	9.8	3.78
	-11.8	-13.0	12.5	4.73	11.9	4.51	11.2	4.18	10.8	4.02	10.5	3.86	9.8	3.55
	-9.8	-11.0	12.6	4.56	11.9	4.24	11.2	3.94	10.8	3.79	10.5	3.64	9.8	3.35
	-9.5	-10.0	12.6	4.43	11.9	4.12	11.2	3.83	10.8	3.68	10.5	3.54	9.8	3.26
	-8.5	-9.1	12.6	4.31	11.9	4.02	11.2	3.73	10.8	3.59	10.5	3.45	9.8	3.18
	-7.0	-7.6	12.6	4.14	11.9	3.86	11.2	3.59	10.8	3.45	10.5	3.32	9.8	3.06
	-5.0	-5.6	12.6	3.93	11.9	3.67	11.2	3.41	10.8	3.28	10.5	3.16	9.8	2.92
	-3.0	-3.7	12.6	3.75	11.9	3.50	11.2	3.26	10.8	3.14	10.5	3.02	9.8	2.79
	0.0	-0.7	12.6	3.49	11.9	3.27	11.2	3.04	10.8	2.93	10.5	2.83	9.8	2.61
	3.0	2.2	12.6	3.28	11.9	3.07	11.2	2.86	10.8	2.76	10.5	2.66	9.8	2.47
	5.0	4.1	12.6	3.16	11.9	2.96	11.2	2.76	10.8	2.66	10.5	2.57	9.8	2.38
	7.0	6.0	12.6	3.04	11.9	2.85	11.2	2.66	10.8	2.57	10.5	2.48	9.8	2.30
9.0	7.9	12.6	2.94	11.9	2.75	11.2	2.57	10.8	2.48	10.5	2.39	9.8	2.22	
11.0	9.8	12.6	2.84	11.9	2.66	11.2	2.49	10.8	2.40	10.5	2.32	9.8	2.15	
13.0	11.8	12.6	2.74	11.9	2.57	11.2	2.41	10.8	2.32	10.5	2.24	9.8	2.08	
15.0	13.7	12.6	2.66	11.9	2.49	11.2	2.33	10.8	2.25	10.5	2.18	9.8	2.02	
60% 8.40 kW (75)	-19.8	-20.0	10.2	4.65	10.2	4.74	9.6	4.41	9.3	4.23	9.0	4.06	8.4	3.73
	-18.8	-19.0	10.5	4.70	10.2	4.58	9.6	4.24	9.3	4.08	9.0	3.92	8.4	3.60
	-16.7	-17.0	10.8	4.58	10.2	4.26	9.6	3.95	9.3	3.80	9.0	3.65	8.4	3.36
	-13.7	-15.0	10.8	4.28	10.2	3.99	9.6	3.70	9.3	3.56	9.0	3.43	8.4	3.16
	-11.8	-13.0	10.8	4.02	10.2	3.75	9.6	3.48	9.3	3.35	9.0	3.23	8.4	2.98
	-9.8	-11.0	10.8	3.79	10.2	3.53	9.6	3.29	9.3	3.17	9.0	3.05	8.4	2.82
	-9.5	-10.0	10.8	3.68	10.2	3.44	9.6	3.20	9.3	3.08	9.0	2.97	8.4	2.74
	-8.5	-9.1	10.8	3.59	10.2	3.35	9.6	3.12	9.3	3.01	9.0	2.90	8.4	2.68
	-7.0	-7.6	10.8	3.45	10.2	3.23	9.6	3.01	9.3	2.90	9.0	2.79	8.4	2.58
	-5.0	-5.6	10.8	3.28	10.2	3.07	9.6	2.86	9.3	2.76	9.0	2.66	8.4	2.46
	-3.0	-3.7	10.8	3.14	10.2	2.94	9.6	2.74	9.3	2.64	9.0	2.55	8.4	2.36
	0.0	-0.7	10.8	2.93	10.2	2.75	9.6	2.57	9.3	2.48	9.0	2.39	8.4	2.22
	3.0	2.2	10.8	2.76	10.2	2.59	9.6	2.42	9.3	2.34	9.0	2.26	8.4	2.10
	5.0	4.1	10.8	2.66	10.2	2.50	9.6	2.34	9.3	2.26	9.0	2.18	8.4	2.03
	7.0	6.0	10.8	2.57	10.2	2.41	9.6	2.26	9.3	2.18	9.0	2.11	8.4	1.96
9.0	7.9	10.8	2.48	10.2	2.33	9.6	2.18	9.3	2.11	9.0	2.04	8.4	1.90	
11.0	9.8	10.8	2.40	10.2	2.26	9.6	2.12	9.3	2.05	9.0	1.98	8.4	1.84	
13.0	11.8	10.8	2.32	10.2	2.18	9.6	2.05	9.3	1.98	9.0	1.92	8.4	1.79	
15.0	13.7	10.8	2.25	10.2	2.12	9.6	1.99	9.3	1.93	9.0	1.86	8.4	1.74	
50% 7.00 kW (63)	-19.8	-20.0	9.0	4.09	8.5	3.81	8.0	3.54	7.7	3.41	7.5	3.28	7.0	3.03
	-18.8	-19.0	9.0	3.94	8.5	3.68	8.0	3.42	7.7	3.29	7.5	3.17	7.0	2.92
	-16.7	-17.0	9.0	3.68	8.5	3.43	8.0	3.20	7.7	3.08	7.5	2.96	7.0	2.74
	-13.7	-15.0	9.0	3.45	8.5	3.22	8.0	3.00	7.7	2.89	7.5	2.79	7.0	2.58
	-11.8	-13.0	9.0	3.24	8.5	3.04	8.0	2.83	7.7	2.73	7.5	2.63	7.0	2.44
	-9.8	-11.0	9.0	3.07	8.5	2.87	8.0	2.68	7.7	2.59	7.5	2.49	7.0	2.31
	-9.5	-10.0	9.0	2.98	8.5	2.80	8.0	2.61	7.7	2.52	7.5	2.43	7.0	2.25
	-8.5	-9.1	9.0	2.91	8.5	2.73	8.0	2.55	7.7	2.46	7.5	2.38	7.0	2.21
	-7.0	-7.6	9.0	2.81	8.5	2.63	8.0	2.46	7.7	2.38	7.5	2.29	7.0	2.13
	-5.0	-5.6	9.0	2.68	8.5	2.51	8.0	2.35	7.7	2.27	7.5	2.19	7.0	2.04
	-3.0	-3.7	9.0	2.56	8.5	2.41	8.0	2.25	7.7	2.18	7.5	2.10	7.0	1.96
	0.0	-0.7	9.0	2.40	8.5	2.26	8.0	2.12	7.7	2.05	7.5	1.98	7.0	1.84
	3.0	2.2	9.0	2.27	8.5	2.14	8.0	2.00	7.7	1.94	7.5	1.87	7.0	1.75
	5.0	4.1	9.0	2.19	8.5	2.06	8.0	1.94	7.7	1.87	7.5	1.81	7.0	1.69
	7.0	6.0	9.0	2.12	8.5	1.99	8.0	1.87	7.7	1.81	7.5	1.76	7.0	1.64
9.0	7.9	9.0	2.05	8.5	1.93	8.0	1.82	7.7	1.76	7.5	1.70	7.0	1.59	
11.0	9.8	9.0	1.99	8.5	1.87	8.0	1.76	7.7	1.71	7.5	1.65	7.0	1.55	
13.0	11.8	9.0	1.93	8.5	1.82	8.0	1.71	7.7	1.66	7.5	1.60	7.0	1.50	
15.0	13.7	9.0	1.87	8.5	1.77	8.0	1.66	7.7	1.61	7.5	1.56	7.0	1.46	

4TW32032-2

5 Capacity tables

5 - 2 Heating Capacity Tables

ERQ200AW1

Heating

TC: Total capacity; kW; PI: Power Input; kW (Comp. + Outdoor fan motor)

Combination % kW (Capacity index)	Outdoor air temp.		Indoor air temp. °CWB											
			16.0		18.0		20.0		21.0		22.0		24.0	
			TC kW	PI kW	TC kW	PI kW	TC kW	PI kW	TC kW	PI kW	TC kW	PI kW	TC kW	PI kW
100% 22.40 kW (200)	-19.8	-20.0	16.0	4.84	16.0	5.05	15.9	5.26	15.9	5.36	15.9	5.46	15.8	5.67
	-18.8	-19.0	16.5	4.96	16.4	5.16	16.4	5.36	16.4	5.46	16.3	5.56	16.3	5.75
	-16.7	-17.0	17.4	5.16	17.4	5.35	17.4	5.54	17.3	5.63	17.3	5.73	17.3	5.92
	-13.7	-15.0	18.4	5.35	18.4	5.53	18.3	5.70	18.3	5.79	18.3	5.88	18.2	6.06
	-11.8	-13.0	19.4	5.51	19.3	5.68	19.3	5.85	19.3	5.94	19.2	6.02	19.2	6.19
	-9.8	-11.0	20.3	5.66	20.3	5.82	20.2	5.99	20.2	6.07	20.2	6.15	20.1	6.31
	-9.5	-10.0	20.8	5.73	20.8	5.89	20.7	6.05	20.7	6.13	20.7	6.20	20.6	6.36
	-8.5	-9.1	21.2	5.79	21.2	5.95	21.1	6.10	21.1	6.18	21.1	6.25	21.1	6.41
	-7.0	-7.6	22.0	5.89	21.9	6.04	21.9	6.19	21.8	6.26	21.8	6.33	21.8	6.48
	-5.0	-5.6	22.9	6.01	22.9	6.15	22.8	6.29	22.8	6.36	22.8	6.43	21.8	6.15
	-3.0	-3.7	23.8	6.11	23.8	6.25	23.7	6.38	23.7	6.45	23.4	6.39	21.8	5.86
	0.0	-0.7	25.3	6.26	25.2	6.39	25.0	6.44	24.2	6.19	23.4	5.94	21.8	5.45
	3.0	2.2	26.7	6.39	26.6	6.50	25.0	6.03	24.2	5.79	23.4	5.56	21.8	5.11
	5.0	4.1	27.6	6.47	26.6	6.24	25.0	5.78	24.2	5.56	23.4	5.34	21.8	4.91
	7.0	6.0	28.2	6.44	26.6	5.99	25.0	5.56	24.2	5.35	23.4	5.14	21.8	4.73
9.0	7.9	28.2	6.19	26.6	5.77	25.0	5.35	24.2	5.15	23.4	4.95	21.8	4.56	
11.0	9.8	28.2	5.96	26.6	5.56	25.0	5.16	24.2	4.97	23.4	4.78	21.8	4.40	
13.0	11.8	28.2	5.74	26.6	5.35	25.0	4.98	24.2	4.79	23.4	4.61	21.8	4.25	
15.0	13.7	28.2	5.55	26.6	5.17	25.0	4.81	24.2	4.63	23.4	4.46	21.8	4.11	
90% 20.16 kW (180)	-19.8	-20.0	15.9	5.21	15.9	5.39	15.8	5.58	15.8	5.67	15.8	5.76	15.8	5.95
	-18.8	-19.0	16.4	5.31	16.4	5.49	16.3	5.67	16.3	5.76	16.3	5.85	16.2	6.03
	-16.7	-17.0	17.4	5.49	17.3	5.66	17.3	5.83	17.3	5.92	17.2	6.00	17.2	6.17
	-13.7	-15.0	18.3	5.66	18.3	5.82	18.2	5.98	18.2	6.06	18.2	6.14	18.2	6.30
	-11.8	-13.0	19.3	5.81	19.2	5.96	19.2	6.11	19.2	6.19	19.2	6.27	19.1	6.42
	-9.8	-11.0	20.2	5.95	20.2	6.09	20.2	6.24	20.1	6.31	20.1	6.38	19.6	6.28
	-9.5	-10.0	20.7	6.01	20.7	6.15	20.6	6.29	20.6	6.36	20.6	6.43	19.6	6.10
	-8.5	-9.1	21.2	6.06	21.1	6.20	21.1	6.34	21.1	6.41	21.0	6.48	19.6	5.95
	-7.0	-7.6	21.9	6.15	21.8	6.28	21.8	6.42	21.8	6.48	21.1	6.22	19.6	5.71
	-5.0	-5.6	22.8	6.26	22.8	6.38	22.5	6.39	21.8	6.14	21.1	5.90	19.6	5.41
	-3.0	-3.7	23.8	6.35	23.7	6.47	22.5	6.09	21.8	5.85	21.1	5.62	19.6	5.17
	0.0	-0.7	25.2	6.49	23.9	6.11	22.5	5.67	21.8	5.45	21.1	5.24	19.6	4.82
	3.0	2.2	25.4	6.14	23.9	5.72	22.5	5.31	21.8	5.11	21.1	4.91	19.6	4.53
	5.0	4.1	25.4	5.89	23.9	5.49	22.5	5.10	21.8	4.91	21.1	4.72	19.6	4.35
	7.0	6.0	25.4	5.66	23.9	5.28	22.5	4.91	21.8	4.73	21.1	4.55	19.6	4.20
9.0	7.9	25.4	5.45	23.9	5.09	22.5	4.73	21.8	4.56	21.1	4.39	19.6	4.05	
11.0	9.8	25.4	5.26	23.9	4.91	22.5	4.57	21.8	4.40	21.1	4.24	19.6	3.91	
13.0	11.8	25.4	5.07	23.9	4.73	22.5	4.41	21.8	4.25	21.1	4.09	19.6	3.78	
15.0	13.7	25.4	4.90	23.9	4.58	22.5	4.27	21.8	4.11	21.1	3.96	19.6	3.66	
80% 17.92 kW (160)	-19.8	-20.0	15.8	5.57	15.8	5.73	15.8	5.90	15.8	5.98	15.7	6.06	15.7	6.22
	-18.8	-19.0	16.3	5.66	16.3	5.82	16.3	5.98	16.2	6.06	16.2	6.14	16.2	6.30
	-16.7	-17.0	17.3	5.82	17.2	5.97	17.2	6.12	17.2	6.20	17.2	6.28	17.1	6.43
	-13.7	-15.0	18.2	5.97	18.2	6.11	18.2	6.26	18.2	6.33	18.1	6.40	17.4	6.16
	-11.8	-13.0	19.2	6.11	19.2	6.24	19.1	6.38	19.1	6.44	18.7	6.31	17.4	5.78
	-9.8	-11.0	20.2	6.23	20.1	6.36	20.0	6.44	19.4	6.18	18.7	5.93	17.4	5.45
	-9.5	-10.0	20.6	6.28	20.6	6.41	20.0	6.25	19.4	6.00	18.7	5.76	17.4	5.29
	-8.5	-9.1	21.1	6.33	21.0	6.46	20.0	6.09	19.4	5.85	18.7	5.62	17.4	5.16
	-7.0	-7.6	21.8	6.41	21.3	6.30	20.0	5.84	19.4	5.62	18.7	5.40	17.4	4.96
	-5.0	-5.6	22.6	6.42	21.3	5.98	20.0	5.54	19.4	5.33	18.7	5.12	17.4	4.72
	-3.0	-3.7	22.6	6.11	21.3	5.70	20.0	5.29	19.4	5.09	18.7	4.89	17.4	4.51
	0.0	-0.7	22.6	5.69	21.3	5.30	20.0	4.93	19.4	4.75	18.7	4.57	17.4	4.21
	3.0	2.2	22.6	5.33	21.3	4.98	20.0	4.63	19.4	4.46	18.7	4.29	17.4	3.96
	5.0	4.1	22.6	5.12	21.3	4.78	20.0	4.45	19.4	4.29	18.7	4.13	17.4	3.82
	7.0	6.0	22.6	4.93	21.3	4.60	20.0	4.29	19.4	4.14	18.7	3.98	17.4	3.68
9.0	7.9	22.6	4.75	21.3	4.44	20.0	4.14	19.4	3.99	18.7	3.85	17.4	3.56	
11.0	9.8	22.6	4.58	21.3	4.29	20.0	4.00	19.4	3.86	18.7	3.72	17.4	3.44	
13.0	11.8	22.6	4.42	21.3	4.14	20.0	3.86	19.4	3.73	18.7	3.59	17.4	3.33	
15.0	13.7	22.6	4.28	21.3	4.01	20.0	3.74	19.4	3.61	18.7	3.48	17.4	3.23	

4TW32032-2

NOTES - ANMERKUNGEN - Σημειώσεις - NOTAS - REMARQUES - NOTE - OPMERKINGEN - примечания - NOTLAR

- is shown as reference
 - When selecting the unit models, avoid the outdoor air temperature range shown by ■
 - dient als Verweis.
 - Vermeiden Sie bei der Auswahl der Gerätemodelle den als ■ markierten Temperaturbereich der Außenluft.
 - εμφανίζεται σαν τιμή αναφοράς.
 - Κατά την επιλογή μοντέλων μονάδων, αποφύγετε την περιοχή θερμοκρασίας εξωτερικού αέρα που εμφανίζεται στο. ■
 - se muestra a modo de referencia.
 - Cuando seleccione los modelos de unidad, evite el intervalo de temperaturas del aire exterior indicado mediante ■
 - est indiqué à titre de référence.
 - Lors de la sélection des modèles d'unité, évitez la plage de température d'air extérieur repérée par ■
 - viene mostrato come riferimento.
 - Nel selezionare i modelli delle unità, non considerare i valori di temperatura dell'aria esterna indicati con il colore ■
 - wordt ter referentie opgegeven
 - Bij selectie van de modellen dient u het gemarkeerde ■ bereik voor de buitenluchttemperatuur te vermijden.
 - приведено для справки
 - При выборе моделей блоков избегайте диапазон температура наружного воздуха, показанный в ■
 - referans olarak görülmektedir.
 - Ünite modellerini seçerken, görülen dış hava sıcaklığı aralığından kaçının ■
- The above table shows the average value of conditions which may occur.
 - Die obige Tabelle zeigt den Durchschnittswert der Bedingungen, die auftreten können.
 - Στον παραπάνω πίνακα αναγράφεται η μέση τιμή για συνθήκες που μπορεί να προκύψουν.
 - La tabla de arriba muestra el valor medio de condiciones que pueden ocurrir.
 - Le tableau ci-dessus donne la valeur moyenne pour des conditions qui peuvent survenir.
 - La tabella in alto mostra il valore delle condizioni medie che si possono riscontrare.
 - De tabel hierboven geeft de gemiddelde waarde aan van situaties die kunnen voorvallen.
 - Таблица расположенная выше показывает среднее значение условий, которые могут наступить.
 - Yukarıdaki tablo meydana gelebilecek koşulların ortalama değerini göstermektedir.

5 Capacity tables

5 - 2 Heating Capacity Tables

ERQ200AW1

Heating

TC: Total capacity; kW; PI: Power Input; kW (Comp. + Outdoor fan motor)

Combination % kW (Capacity index)	Outdoor air temp.		Indoor air temp. °CWB											
			16.0		18.0		20.0		21.0		22.0		24.0	
			TC	PI	TC	PI	TC	PI	TC	PI	TC	PI	TC	PI
	°CDB	°CWB												
70% 15.68 kW (140)	-19.8	-20.0	15.8	5.93	15.7	6.07	15.7	6.22	15.7	6.29	15.7	6.36	15.3	6.25
	-18.8	-19.0	16.2	6.01	16.2	6.15	16.2	6.29	16.2	6.36	16.2	6.43	15.3	6.02
	-16.7	-17.0	17.2	6.15	17.2	6.29	17.1	6.42	16.9	6.37	16.4	6.11	15.3	5.61
	-13.7	-15.0	18.2	6.28	18.1	6.41	17.5	6.19	16.9	5.95	16.4	5.71	15.3	5.25
	-11.8	-13.0	19.1	6.40	18.6	6.27	17.5	5.81	16.9	5.59	16.4	5.37	15.3	4.93
	-9.8	-11.0	19.7	6.34	18.6	5.90	17.5	5.47	16.9	5.27	16.4	5.06	15.3	4.66
	-9.5	-10.0	19.7	6.15	18.6	5.73	17.5	5.32	16.9	5.12	16.4	4.92	15.3	4.53
	-8.5	-9.1	19.7	6.00	18.6	5.59	17.5	5.19	16.9	4.99	16.4	4.80	15.3	4.42
	-7.0	-7.6	19.7	5.75	18.6	5.36	17.5	4.99	16.9	4.80	16.4	4.62	15.3	4.26
	-5.0	-5.6	19.7	5.46	18.6	5.09	17.5	4.74	16.9	4.56	16.4	4.39	15.3	4.05
	-3.0	-3.7	19.7	5.21	18.6	4.86	17.5	4.53	16.9	4.36	16.4	4.20	15.3	3.88
	0.0	-0.7	19.7	4.86	18.6	4.54	17.5	4.23	16.9	4.08	16.4	3.93	15.3	3.63
	3.0	2.2	19.7	4.56	18.6	4.27	17.5	3.98	16.9	3.84	16.4	3.70	15.3	3.43
	5.0	4.1	19.7	4.39	18.6	4.11	17.5	3.83	16.9	3.70	16.4	3.57	15.3	3.30
	7.0	6.0	19.7	4.23	18.6	3.96	17.5	3.70	16.9	3.57	16.4	3.44	15.3	3.19
9.0	7.9	19.7	4.08	18.6	3.82	17.5	3.57	16.9	3.45	16.4	3.33	15.3	3.09	
11.0	9.8	19.7	3.94	18.6	3.70	17.5	3.46	16.9	3.34	16.4	3.22	15.3	2.99	
13.0	11.8	19.7	3.81	18.6	3.57	17.5	3.34	16.9	3.23	16.4	3.12	15.3	2.90	
15.0	13.7	19.7	3.69	18.6	3.47	17.5	3.24	16.9	3.13	16.4	3.03	15.3	2.81	
60% 13.44 kW (120)	-19.8	-20.0	15.7	6.29	15.7	6.41	15.0	6.12	14.5	5.88	14.0	5.65	13.1	5.19
	-18.8	-19.0	16.2	6.36	16.0	6.36	15.0	5.90	14.5	5.67	14.0	5.45	13.1	5.01
	-16.7	-17.0	16.9	6.36	16.0	5.92	15.0	5.50	14.5	5.29	14.0	5.08	13.1	4.68
	-13.7	-15.0	16.9	5.95	16.0	5.54	15.0	5.15	14.5	4.95	14.0	4.76	13.1	4.39
	-11.8	-13.0	16.9	5.58	16.0	5.21	15.0	4.84	14.5	4.66	14.0	4.48	13.1	4.14
	-9.8	-11.0	16.9	5.26	16.0	4.91	15.0	4.57	14.5	4.40	14.0	4.24	13.1	3.91
	-9.5	-10.0	16.9	5.12	16.0	4.78	15.0	4.45	14.5	4.28	14.0	4.13	13.1	3.81
	-8.5	-9.1	16.9	4.99	16.0	4.66	15.0	4.34	14.5	4.18	14.0	4.03	13.1	3.72
	-7.0	-7.6	16.9	4.80	16.0	4.48	15.0	4.18	14.5	4.03	14.0	3.88	13.1	3.59
	-5.0	-5.6	16.9	4.56	16.0	4.27	15.0	3.98	14.5	3.84	14.0	3.70	13.1	3.42
	-3.0	-3.7	16.9	4.36	16.0	4.08	15.0	3.81	14.5	3.67	14.0	3.54	13.1	3.28
	0.0	-0.7	16.9	4.08	16.0	3.82	15.0	3.57	14.5	3.44	14.0	3.32	13.1	3.08
	3.0	2.2	16.9	3.84	16.0	3.60	15.0	3.37	14.5	3.25	14.0	3.14	13.1	2.92
	5.0	4.1	16.9	3.70	16.0	3.47	15.0	3.25	14.5	3.14	14.0	3.03	13.1	2.82
	7.0	6.0	16.9	3.57	16.0	3.35	15.0	3.14	14.5	3.03	14.0	2.93	13.1	2.72
9.0	7.9	16.9	3.45	16.0	3.24	15.0	3.04	14.5	2.93	14.0	2.84	13.1	2.64	
11.0	9.8	16.9	3.34	16.0	3.14	15.0	2.94	14.5	2.84	14.0	2.75	13.1	2.56	
13.0	11.8	16.9	3.23	16.0	3.04	15.0	2.85	14.5	2.76	14.0	2.66	13.1	2.48	
15.0	13.7	16.9	3.13	16.0	2.95	15.0	2.77	14.5	2.68	14.0	2.59	13.1	2.41	
50% 11.20 kW (100)	-19.8	-20.0	14.1	5.68	13.3	5.30	12.5	4.93	12.1	4.74	11.7	4.56	10.9	4.21
	-18.8	-19.0	14.1	5.48	13.3	5.11	12.5	4.75	12.1	4.56	11.7	4.40	10.9	4.06
	-16.7	-17.0	14.1	5.11	13.3	4.77	12.5	4.44	12.1	4.28	11.7	4.12	10.9	3.81
	-13.7	-15.0	14.1	4.79	13.3	4.48	12.5	4.17	12.1	4.02	11.7	3.87	10.9	3.58
	-11.8	-13.0	14.1	4.51	13.3	4.22	12.5	3.94	12.1	3.80	11.7	3.66	10.9	3.39
	-9.8	-11.0	14.1	4.26	13.3	3.99	12.5	3.73	12.1	3.60	11.7	3.47	10.9	3.21
	-9.5	-10.0	14.1	4.15	13.3	3.89	12.5	3.63	12.1	3.50	11.7	3.38	10.9	3.13
	-8.5	-9.1	14.1	4.05	13.3	3.80	12.5	3.55	12.1	3.43	11.7	3.30	10.9	3.07
	-7.0	-7.6	14.1	3.90	13.3	3.66	12.5	3.42	12.1	3.30	11.7	3.19	10.9	2.96
	-5.0	-5.6	14.1	3.72	13.3	3.49	12.5	3.26	12.1	3.15	11.7	3.05	10.9	2.83
	-3.0	-3.7	14.1	3.56	13.3	3.34	12.5	3.13	12.1	3.03	11.7	2.92	10.9	2.72
	0.0	-0.7	14.1	3.34	13.3	3.14	12.5	2.94	12.1	2.85	11.7	2.75	10.9	2.56
	3.0	2.2	14.1	3.15	13.3	2.97	12.5	2.79	12.1	2.70	11.7	2.61	10.9	2.43
	5.0	4.1	14.1	3.05	13.3	2.87	12.5	2.69	12.1	2.61	11.7	2.52	10.9	2.35
	7.0	6.0	14.1	2.94	13.3	2.77	12.5	2.61	12.1	2.52	11.7	2.44	10.9	2.28
9.0	7.9	14.1	2.85	13.3	2.69	12.5	2.52	12.1	2.45	11.7	2.37	10.9	2.21	
11.0	9.8	14.1	2.76	13.3	2.61	12.5	2.45	12.1	2.37	11.7	2.30	10.9	2.15	
13.0	11.8	14.1	2.68	13.3	2.53	12.5	2.38	12.1	2.30	11.7	2.23	10.9	2.09	
15.0	13.7	14.1	2.60	13.3	2.46	12.5	2.31	12.1	2.24	11.7	2.17	10.9	2.03	

4TW32032-2

5 Capacity tables

5 - 2 Heating Capacity Tables

ERQ250AW1

Heating

TC: Total capacity; kW; PI: Power Input; kW (Comp. + Outdoor fan motor)

Combination % kW (Capacity index)	Outdoor air temp.		Indoor air temp. °CWB											
			16.0		18.0		20.0		21.0		22.0		24.0	
			°CDB	°CWB	TC	PI	TC	PI	TC	PI	TC	PI	TC	PI
70% 19.60 kW (175)	-19.8	-20.0	19.8	8.56	19.7	8.76	19.7	8.97	19.7	9.07	19.7	9.18	19.2	9.08
	-18.8	-19.0	20.1	8.63	20.1	8.83	20.0	9.03	20.0	9.13	20.0	9.24	19.2	8.89
	-16.7	-17.0	20.9	8.77	20.9	8.97	20.8	9.16	20.8	9.26	20.6	9.25	19.2	8.48
	-13.7	-15.0	21.8	8.92	21.7	9.11	21.7	9.30	21.3	9.16	20.6	8.79	19.2	8.06
	-11.8	-13.0	22.7	9.07	22.7	9.25	22.1	9.03	21.3	8.68	20.6	8.33	19.2	7.64
	-9.8	-11.0	23.8	9.22	23.5	9.21	22.1	8.53	21.3	8.20	20.6	7.87	19.2	7.23
	-9.5	-10.0	24.4	9.30	23.5	8.94	22.1	8.28	21.3	7.96	20.6	7.65	19.2	7.03
	-8.5	-9.1	24.9	9.35	23.5	8.70	22.1	8.06	21.3	7.75	20.6	7.45	19.2	6.85
	-7.0	-7.6	24.9	8.93	23.5	8.31	22.1	7.71	21.3	7.42	20.6	7.13	19.2	6.56
	-5.0	-5.6	24.9	8.39	23.5	7.82	22.1	7.26	21.3	6.98	20.6	6.71	19.2	6.19
	-3.0	-3.7	24.9	7.90	23.5	7.37	22.1	6.85	21.3	6.59	20.6	6.34	19.2	5.85
	0.0	-0.7	24.9	7.19	23.5	6.72	22.1	6.25	21.3	6.02	20.6	5.80	19.2	5.36
	3.0	2.2	24.9	6.57	23.5	6.15	22.1	5.73	21.3	5.52	20.6	5.32	19.2	4.92
	5.0	4.1	24.9	6.20	23.5	5.80	22.1	5.42	21.3	5.22	20.6	5.03	19.2	4.66
	7.0	6.0	24.9	5.86	23.5	5.49	22.1	5.12	21.3	4.94	20.6	4.77	19.2	4.42
9.0	7.9	24.9	5.54	23.5	5.19	22.1	4.85	21.3	4.68	20.6	4.52	19.2	4.19	
11.0	9.8	24.9	5.24	23.5	4.91	22.1	4.60	21.3	4.44	20.6	4.29	19.2	3.98	
13.0	11.8	24.9	4.95	23.5	4.65	22.1	4.35	21.3	4.21	20.6	4.06	19.2	3.78	
15.0	13.7	24.9	4.69	23.5	4.41	22.1	4.13	21.3	4.00	20.6	3.86	19.2	3.60	
60% 16.80 kW (150)	-19.8	-20.0	19.7	9.08	19.6	9.25	18.9	8.90	18.3	8.55	17.7	8.21	16.5	7.53
	-18.8	-19.0	20.0	9.14	20.0	9.31	18.9	8.71	18.3	8.37	17.7	8.03	16.5	7.37
	-16.7	-17.0	20.8	9.26	20.1	8.97	18.9	8.31	18.3	7.99	17.7	7.67	16.5	7.05
	-13.7	-15.0	21.3	9.16	20.1	8.52	18.9	7.90	18.3	7.60	17.7	7.30	16.5	6.71
	-11.8	-13.0	21.3	8.67	20.1	8.07	18.9	7.49	18.3	7.21	17.7	6.93	16.5	6.38
	-9.8	-11.0	21.3	8.19	20.1	7.63	18.9	7.09	18.3	6.82	17.7	6.56	16.5	6.05
	-9.5	-10.0	21.3	7.96	20.1	7.42	18.9	6.89	18.3	6.64	17.7	6.38	16.5	5.88
	-8.5	-9.1	21.3	7.75	20.1	7.23	18.9	6.72	18.3	6.47	17.7	6.22	16.5	5.74
	-7.0	-7.6	21.3	7.41	20.1	6.92	18.9	6.43	18.3	6.20	17.7	5.96	16.5	5.51
	-5.0	-5.6	21.3	6.98	20.1	6.52	18.9	6.07	18.3	5.85	17.7	5.63	16.5	5.21
	-3.0	-3.7	21.3	6.59	20.1	6.16	18.9	5.74	18.3	5.54	17.7	5.33	16.5	4.93
	0.0	-0.7	21.3	6.02	20.1	5.64	18.9	5.26	18.3	5.08	17.7	4.89	16.5	4.53
	3.0	2.2	21.3	5.52	20.1	5.18	18.9	4.84	18.3	4.67	17.7	4.51	16.5	4.18
	5.0	4.1	21.3	5.22	20.1	4.90	18.9	4.58	18.3	4.43	17.7	4.27	16.5	3.97
	7.0	6.0	21.3	4.94	20.1	4.64	18.9	4.34	18.3	4.20	17.7	4.06	16.5	3.77
9.0	7.9	21.3	4.68	20.1	4.40	18.9	4.12	18.3	3.99	17.7	3.85	16.5	3.59	
11.0	9.8	21.3	4.44	20.1	4.18	18.9	3.92	18.3	3.79	17.7	3.66	16.5	3.42	
13.0	11.8	21.3	4.20	20.1	3.96	18.9	3.72	18.3	3.60	17.7	3.48	16.5	3.25	
15.0	13.7	21.3	4.00	20.1	3.76	18.9	3.54	18.3	3.43	17.7	3.32	16.5	3.10	
50% 14.00 kW (125)	-19.8	-20.0	17.8	8.26	16.8	7.69	15.8	7.14	15.2	6.88	14.7	6.61	13.7	6.09
	-18.8	-19.0	17.8	8.08	16.8	7.53	15.8	7.00	15.2	6.73	14.7	6.47	13.7	5.97
	-16.7	-17.0	17.8	7.71	16.8	7.19	15.8	6.69	15.2	6.44	14.7	6.20	13.7	5.72
	-13.7	-15.0	17.8	7.34	16.8	6.85	15.8	6.37	15.2	6.14	14.7	5.91	13.7	5.46
	-11.8	-13.0	17.8	6.97	16.8	6.51	15.8	6.06	15.2	5.84	14.7	5.62	13.7	5.20
	-9.8	-11.0	17.8	6.60	16.8	6.17	15.8	5.75	15.2	5.54	14.7	5.34	13.7	4.94
	-9.5	-10.0	17.8	6.42	16.8	6.00	15.8	5.60	15.2	5.40	14.7	5.20	13.7	4.81
	-8.5	-9.1	17.8	6.26	16.8	5.86	15.8	5.46	15.2	5.27	14.7	5.08	13.7	4.70
	-7.0	-7.6	17.8	6.00	16.8	5.62	15.8	5.24	15.2	5.06	14.7	4.88	13.7	4.52
	-5.0	-5.6	17.8	5.66	16.8	5.31	15.8	4.96	15.2	4.79	14.7	4.62	13.7	4.28
	-3.0	-3.7	17.8	5.36	16.8	5.03	15.8	4.70	15.2	4.54	14.7	4.38	13.7	4.07
	0.0	-0.7	17.8	4.92	16.8	4.62	15.8	4.33	15.2	4.18	14.7	4.04	13.7	3.76
	3.0	2.2	17.8	4.53	16.8	4.26	15.8	3.99	15.2	3.86	14.7	3.73	13.7	3.48
	5.0	4.1	17.8	4.30	16.8	4.04	15.8	3.79	15.2	3.67	14.7	3.55	13.7	3.31
	7.0	6.0	17.8	4.08	16.8	3.84	15.8	3.61	15.2	3.49	14.7	3.38	13.7	3.16
9.0	7.9	17.8	3.87	16.8	3.65	15.8	3.43	15.2	3.33	14.7	3.22	13.7	3.01	
11.0	9.8	17.8	3.68	16.8	3.47	15.8	3.27	15.2	3.17	14.7	3.07	13.7	2.87	
13.0	11.8	17.8	3.50	16.8	3.30	15.8	3.11	15.2	3.02	14.7	2.92	13.7	2.74	
15.0	13.7	17.8	3.33	16.8	3.15	15.8	2.97	15.2	2.88	14.7	2.79	13.7	2.62	

4TW32032-2

NOTES - ANMERKUNGEN - Σημειώσεις - NOTAS - REMARQUES - NOTE - OPMERKINGEN - примечания - NOTLAR

- is shown as reference
 - When selecting the unit models, avoid the outdoor air temperature range shown by ■
 - dient als Verweis.
 - Vermeiden Sie bei der Auswahl der Gerätemodelle den als ■ markierten Temperaturbereich der Außenluft.
 - εμφανίζεται σαν τιμή αναφοράς.
 - Κατά την επιλογή μοντέλων μονάδων, αποφύγετε την περιοχή θερμοκρασίας εξωτερικού αέρα που εμφανίζεται στο. ■
 - se muestra a modo de referencia.
 - Cuando seleccione los modelos de unidad, evite el intervalo de temperaturas del aire exterior indicado mediante ■
 - est indiqué à titre de référence.
 - Lors de la sélection des modèles d'unité, évitez la plage de température d'air extérieur repérée par ■
 - viene mostrato come riferimento.
 - Nel selezionare i modelli delle unità, non considerare i valori di temperatura dell'aria esterna indicati con il colore ■
 - wordt ter referentie opgegeven
 - Bij selectie van de modellen dient u het gemarkeerde ■ bereik voor de buitenluchttemperatuur te vermijden.
 - приведено для справки
 - При выборе моделей блоков избегайте диапазон температура наружного воздуха, показанный в ■
 - referans olarak görülmektedir.
 - Ünite modellerini seçerken, görülen dış hava sıcaklığı aralığından kaçının ■
- The above table shows the average value of conditions which may occur.
 - Die obige Tabelle zeigt den Durchschnittswert der Bedingungen, die auftreten können.
 - Στον παραπάνω πίνακα αναγράφεται η μέση τιμή για συνθήκες που μπορεί να προκύψουν.
 - La tabla de arriba muestra el valor medio de condiciones que pueden ocurrir.
 - Le tableau ci-dessus donne la valeur moyenne pour des conditions qui peuvent survenir.
 - La tabella in alto mostra il valore delle condizioni medie che si possono riscontrare.
 - De tabel hierboven geeft de gemiddelde waarde aan van situaties die kunnen voorvallen.
 - Таблица расположенная выше показывает среднее значение условий, которые могут наступить.
 - Yukarıdaki tablo meydana gelebilecek koşulların ortalama değerini göstermektedir.

5 Capacity tables

5 - 2 Heating Capacity Tables

ERQ250AW1

Heating

TC: Total capacity; kW; PI: Power Input; kW (Comp. + Outdoor fan motor)

Combination % kW (Capacity index)	Outdoor air temp. °CDB °CWB		Indoor air temp. °CWB											
			16.0		18.0		20.0		21.0		22.0		24.0	
			TC kW	PI kW	TC kW	PI kW	TC kW	PI kW	TC kW	PI kW	TC kW	PI kW	TC kW	PI kW
100% 28.00 kW (250)	-19.8	-20.0	20.1	7.00	20.0	7.29	20.0	7.59	19.9	7.74	19.9	7.88	19.8	8.18
	-18.8	-19.0	20.4	7.09	20.4	7.38	20.3	7.67	20.3	7.82	20.2	7.97	20.2	8.26
	-16.7	-17.0	21.2	7.29	21.1	7.57	21.1	7.85	21.0	7.99	21.0	8.13	21.0	8.41
	-13.7	-15.0	22.1	7.50	22.0	7.77	21.9	8.04	21.9	8.18	21.9	8.31	21.8	8.58
	-11.8	-13.0	23.0	7.72	23.0	7.97	22.9	8.23	22.9	8.36	22.9	8.49	22.8	8.75
	-9.8	-11.0	24.1	7.93	24.0	8.18	24.0	8.42	24.0	8.55	23.9	8.67	23.9	8.91
	-9.5	-10.0	24.7	8.04	24.6	8.28	24.6	8.52	24.5	8.64	24.5	8.76	24.4	9.00
	-8.5	-9.1	25.2	8.13	25.1	8.37	25.1	8.60	25.1	8.72	25.0	8.84	25.0	9.07
	-7.0	-7.6	26.1	8.29	26.1	8.52	26.0	8.74	26.0	8.86	26.0	8.97	25.9	9.20
	-5.0	-5.6	27.5	8.50	27.4	8.71	27.4	8.93	27.3	9.03	27.3	9.14	27.2	9.36
	-3.0	-3.7	28.8	8.69	28.8	8.89	28.7	9.10	28.7	9.20	28.7	9.30	27.5	8.91
	0.0	-0.7	31.1	8.97	31.1	9.16	31.0	9.35	30.5	9.20	29.5	8.82	27.5	8.09
	3.0	2.2	33.6	9.23	33.5	9.40	31.5	8.70	30.5	8.36	29.5	8.03	27.5	7.37
	5.0	4.1	35.3	9.40	33.5	8.83	31.5	8.18	30.5	7.87	29.5	7.56	27.5	6.95
	7.0	6.0	35.5	8.92	33.5	8.30	31.5	7.70	30.5	7.41	29.5	7.12	27.5	6.55
	9.0	7.9	35.5	8.38	33.5	7.81	31.5	7.25	30.5	6.98	29.5	6.71	27.5	6.18
	11.0	9.8	35.5	7.89	33.5	7.36	31.5	6.84	30.5	6.58	29.5	6.33	27.5	5.84
13.0	11.8	35.5	7.41	33.5	6.92	31.5	6.44	30.5	6.20	29.5	5.97	27.5	5.51	
15.0	13.7	35.5	6.99	33.5	6.53	31.5	6.08	30.5	5.86	29.5	5.64	27.5	5.22	
90% 25.20 kW (225)	-19.8	-20.0	20.0	7.52	19.9	7.78	19.9	8.05	19.8	8.18	19.8	8.32	19.8	8.58
	-18.8	-19.0	20.3	7.60	20.3	7.87	20.2	8.13	20.2	8.26	20.2	8.39	20.1	8.65
	-16.7	-17.0	21.1	7.79	21.0	8.04	21.0	8.29	21.0	8.42	20.9	8.54	20.9	8.79
	-13.7	-15.0	22.0	7.98	21.9	8.22	21.9	8.46	21.8	8.58	21.8	8.70	21.8	8.94
	-11.8	-13.0	22.9	8.17	22.9	8.40	22.8	8.63	22.8	8.75	22.8	8.86	22.7	9.09
	-9.8	-11.0	24.0	8.36	24.0	8.58	23.9	8.80	23.9	8.91	23.9	9.03	23.8	9.25
	-9.5	-10.0	24.6	8.46	24.5	8.68	24.5	8.89	24.4	9.00	24.4	9.11	24.4	9.32
	-8.5	-9.1	25.1	8.55	25.1	8.76	25.0	8.97	25.0	9.07	25.0	9.18	24.7	9.27
	-7.0	-7.6	26.0	8.69	26.0	8.89	25.9	9.10	25.9	9.20	25.9	9.30	24.7	8.85
	-5.0	-5.6	27.4	8.88	27.3	9.07	27.3	9.26	27.2	9.36	26.5	9.07	24.7	8.32
	-3.0	-3.7	28.7	9.05	28.7	9.23	28.4	9.27	27.4	8.90	26.5	8.54	24.7	7.84
	0.0	-0.7	31.1	9.31	30.2	9.08	28.4	8.41	27.4	8.08	26.5	7.76	24.7	7.13
	3.0	2.2	32.0	8.87	30.2	8.26	28.4	7.66	27.4	7.37	26.5	7.08	24.7	6.52
	5.0	4.1	32.0	8.34	30.2	7.77	28.4	7.22	27.4	6.94	26.5	6.68	24.7	6.15
	7.0	6.0	32.0	7.84	30.2	7.32	28.4	6.80	27.4	6.55	26.5	6.30	24.7	5.81
	9.0	7.9	32.0	7.39	30.2	6.89	28.4	6.41	27.4	6.18	26.5	5.95	24.7	5.49
	11.0	9.8	32.0	6.96	30.2	6.50	28.4	6.06	27.4	5.84	26.5	5.62	24.7	5.20
13.0	11.8	32.0	6.55	30.2	6.13	28.4	5.71	27.4	5.51	26.5	5.31	24.7	4.91	
15.0	13.7	32.0	6.19	30.2	5.79	28.4	5.41	27.4	5.22	26.5	5.03	24.7	4.66	
80% 22.40 kW (200)	-19.8	-20.0	19.9	8.04	19.8	8.27	19.8	8.51	19.8	8.63	19.7	8.75	19.7	8.98
	-18.8	-19.0	20.2	8.11	20.2	8.35	20.1	8.58	20.1	8.70	20.1	8.81	20.0	9.05
	-16.7	-17.0	21.0	8.28	20.9	8.50	20.9	8.73	20.9	8.84	20.9	8.95	20.8	9.17
	-13.7	-15.0	21.9	8.45	21.8	8.66	21.8	8.88	21.8	8.98	21.7	9.09	21.7	9.31
	-11.8	-13.0	22.8	8.62	22.8	8.83	22.7	9.03	22.7	9.13	22.7	9.24	22.0	8.99
	-9.8	-11.0	23.9	8.79	23.9	8.99	23.8	9.19	23.8	9.28	23.6	9.26	22.0	8.49
	-9.5	-10.0	24.5	8.88	24.4	9.07	24.4	9.26	24.4	9.36	23.6	8.99	22.0	8.24
	-8.5	-9.1	25.0	8.96	25.0	9.15	24.9	9.33	24.4	9.12	23.6	8.75	22.0	8.02
	-7.0	-7.6	25.9	9.09	25.9	9.27	25.2	9.07	24.4	8.71	23.6	8.36	22.0	7.67
	-5.0	-5.6	27.3	9.25	26.8	9.20	25.2	8.52	24.4	8.19	23.6	7.86	22.0	7.22
	-3.0	-3.7	28.4	9.30	26.8	8.66	25.2	8.02	24.4	7.72	23.6	7.41	22.0	6.82
	0.0	-0.7	28.4	8.44	26.8	7.86	25.2	7.30	24.4	7.03	23.6	6.75	22.0	6.22
	3.0	2.2	28.4	7.69	26.8	7.17	25.2	6.67	24.4	6.42	23.6	6.18	22.0	5.70
	5.0	4.1	28.4	7.24	26.8	6.76	25.2	6.29	24.4	6.06	23.6	5.84	22.0	5.39
	7.0	6.0	28.4	6.82	26.8	6.38	25.2	5.94	24.4	5.73	23.6	5.52	22.0	5.10
	9.0	7.9	28.4	6.44	26.8	6.02	25.2	5.61	24.4	5.41	23.6	5.22	22.0	4.83
	11.0	9.8	28.4	6.08	26.8	5.69	25.2	5.31	24.4	5.12	23.6	4.94	22.0	4.58
13.0	11.8	28.4	5.73	26.8	5.37	25.2	5.02	24.4	4.84	23.6	4.67	22.0	4.33	
15.0	13.7	28.4	5.42	26.8	5.09	25.2	4.76	24.4	4.59	23.6	4.43	22.0	4.12	

4TW32032-2

5 Capacity tables

5 - 3 Integrated Heating Capacity Correction Factor

5

ERQ-AW1

Integrated heating capacity coefficient

The heating capacity tables do not take account of the reduction in capacity, when frost has accumulated or while the defrosting operation is in progress. The capacity values, which take these factors into account, in other words, the integrated heating capacity values, can be calculated as follows

Formula:
 Integrated heating capacity = A
 Value given in table of capacity characteristics = B
 Integrating correction factor for frost accumulation (kW) = C
 $A = B \times C$

Correction factor for finding integrated heating capacity

Inlet port temperature of heat exchanger (°C/RH 85%)	-7	-5	-3	0	3	5	7
Integrating correction factor for frost accumulation	0,96	0,93	0,87	0,81	0,83	0,89	1,0

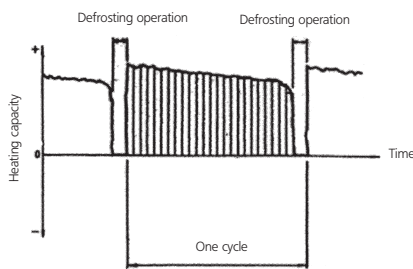

Note:
 1. The figures shows that the integrated heating capacity expresses the integrated capacity for a single cycle (from defrost operation to defrost operation) in terms of time.

Please note that, when there is an accumulation of snow against the outside surface of the outdoor unit heat exchanger, there will always be a temporary reduction in capacity, although this will of course vary in degree in accordance with a number of other factors, such as the outdoor temperature (°CDB), relative humidity (RH) and the amount of frosting which occurs.

3TW27232-7

5 Capacity tables

5 - 4 Capacity Correction Factor

ERQ-AW1

Correction factor for piping length (α)
Cooling

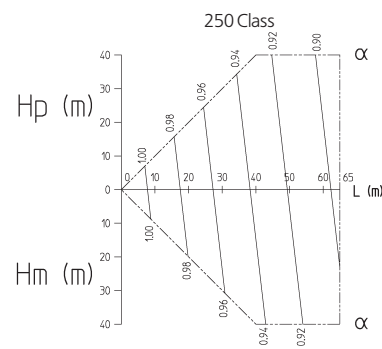
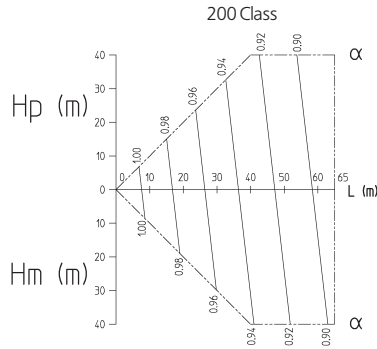
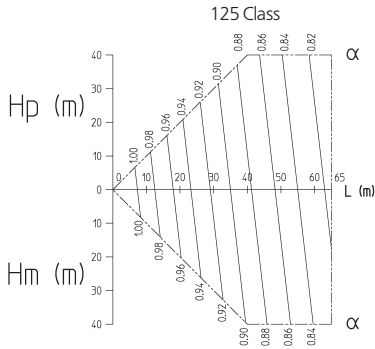

Correction factor for piping length (α)
Heating

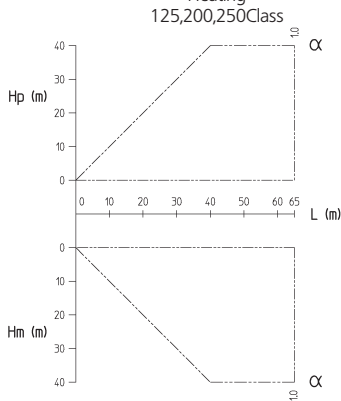

Explanation of symbols:

- Hp: Level difference between air handling unit and outdoorunit when air handling unit is installed below the outdoor unit
- Hm: Level difference between air handling unit and outdoorunit when air handling unit is installed above the outdoor unit
- L: Equivalent piping length (m)
- α: Capacity correction factor

Diameter of pipes:

Outdoor unit class	Gas	Liquid
125	φ 15.9	φ 9.5
200	φ 19.1	φ 9.5
250	φ 22.2	φ 9.5

Notes:

- 1 These figures illustrate the correction factor for piping length of the system at maximum load under standard conditions. Under partial load conditions there is only minor deviation from the correction factor shown in the figures above.
- 2 Method of calculating cooling capacity (max. capacity)
Cooling capacity = Cooling capacity obtained from the cooling capacity characteristics table X Capacity correction factor
- 3 Method of calculating heating capacity (max. capacity)
Heating capacity = Heating capacity obtained from the heating capacity characteristics table X Capacity correction factor

3TW32032-2

6 Dimensional drawings

6 - 1 Dimensional Drawings

6

ERQ125AW1

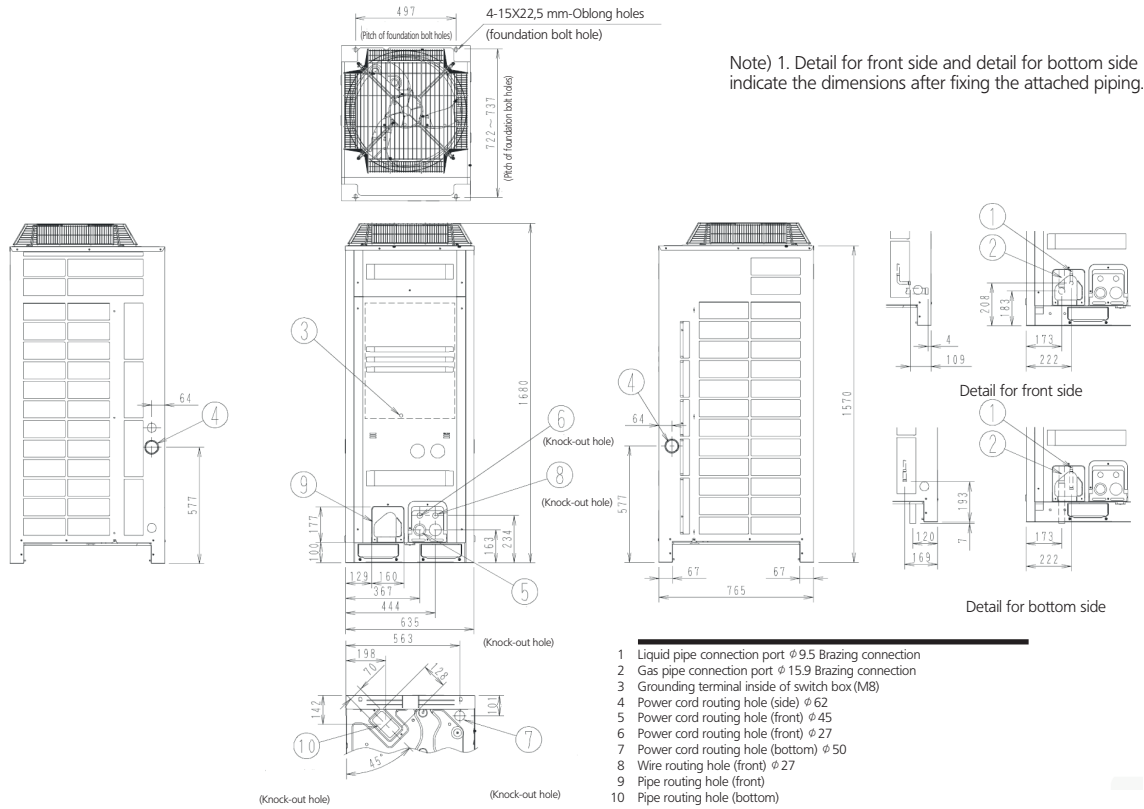

3D051448F

ERQ200,250AW1B

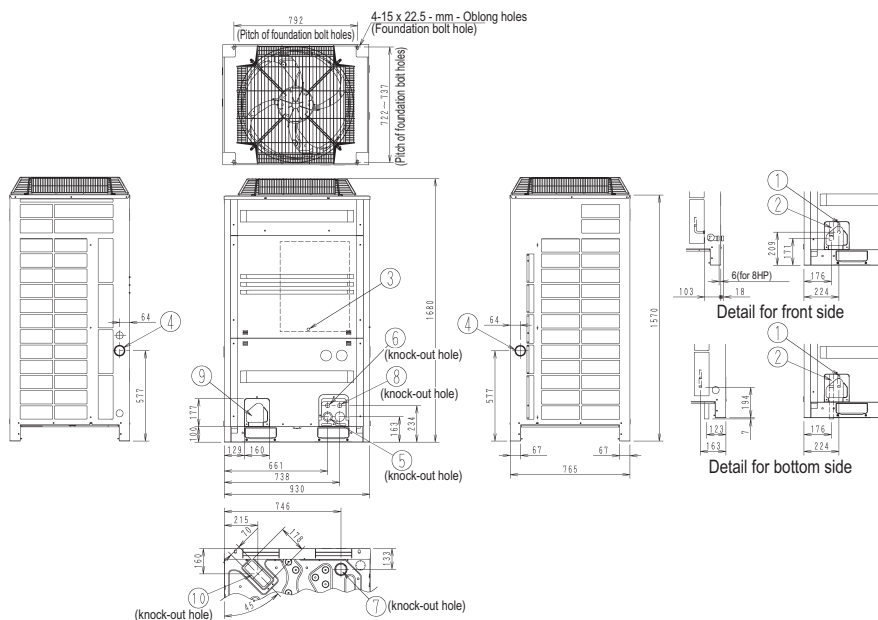

3D051449P

No.	Parts name	Remarks
1	Liquid pipe connection port	See note 2
2	Gas pipe connection port	See note 2
3	Grounding terminal	Inside of switch box (M8)
4	Power cord routing hole (side)	ø 62
5	Power cord routing hole (front)	ø 45
6	Power cord routing hole (front)	ø 27
7	Power cord routing hole (bottom)	ø 66.5
8	Wire routing hole (front)	ø 27
9	Pipe routing hole (front)	
10	Pipe routing hole (bottom)	

NOTES

- Detail for front side and detail for bottom side indicate the dimensions after fixing the attached piping.
- Gas pipe (Heat pump type)
 - ø 19.1 Brazing connection 8PY1, YL, 8PAY1(S), Y6, YL, YLD(9), 200KY1, 8PTLK, 8PYNK, 8PRY6 type RQYQ8PY1, PY1B, RXYQ8PYLT, RXYQ8PTLT, RZQS180 • 200AY1, RZQ180 • 200LY1
 - ø 22.2 Brazing connection 10PY1, YL, 10PAY1(S), Y6, YL, YLD, 10PRY6 type RQYQ10PY1, PY1B, RXYQ10PYLT, RXYQ10PTLT, RZQ250LY1
 - ø 28.6 Brazing connection RQYQ12PY1, PY1B
- Liquid pipe (Heat pump type)
 - ø 9.5 Brazing connection 8 • 10PY1, YL, 8 • 10PAY1(S), Y6, YL, YLD(9), 200KY1, 8PTLK, 8PYNK, 8 • 10PRY6 type RQYQ8 • 10PY1, PY1B, RXYQ8 • 10PYLT, RXYQ8 • 10PTLT, RZQS180 • 200AY1, RZQ180 • 200 • 250LY1
 - ø 12.7 Brazing connection RQYQ12PY1, PY1B

6 Dimensional drawings

6 - 2 Dimensional Drawings with Accessories

ERQ125AW1

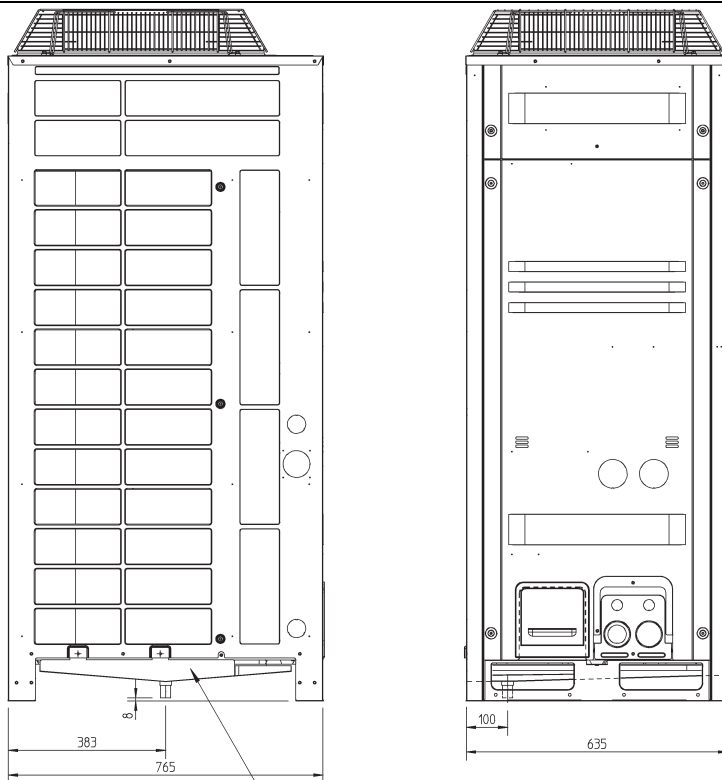

① Central drain pan kit (KWC26B160)

3TW27234-1

ERQ200,250AW1

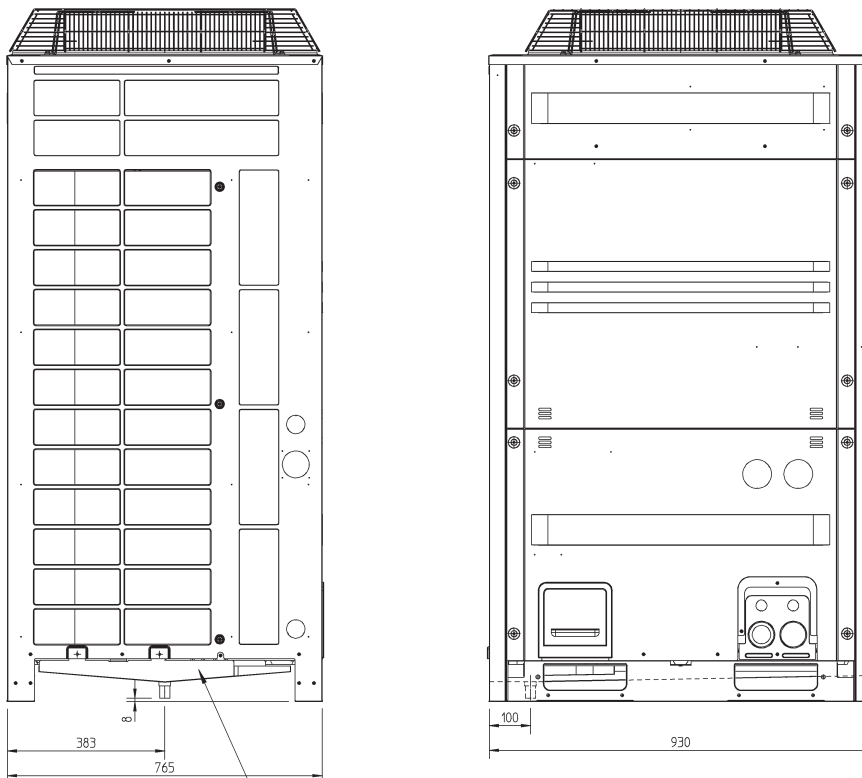

①

3TW27244-1

7 Centre of gravity

7 - 1 Centre of Gravity

7

ERQ125AW1

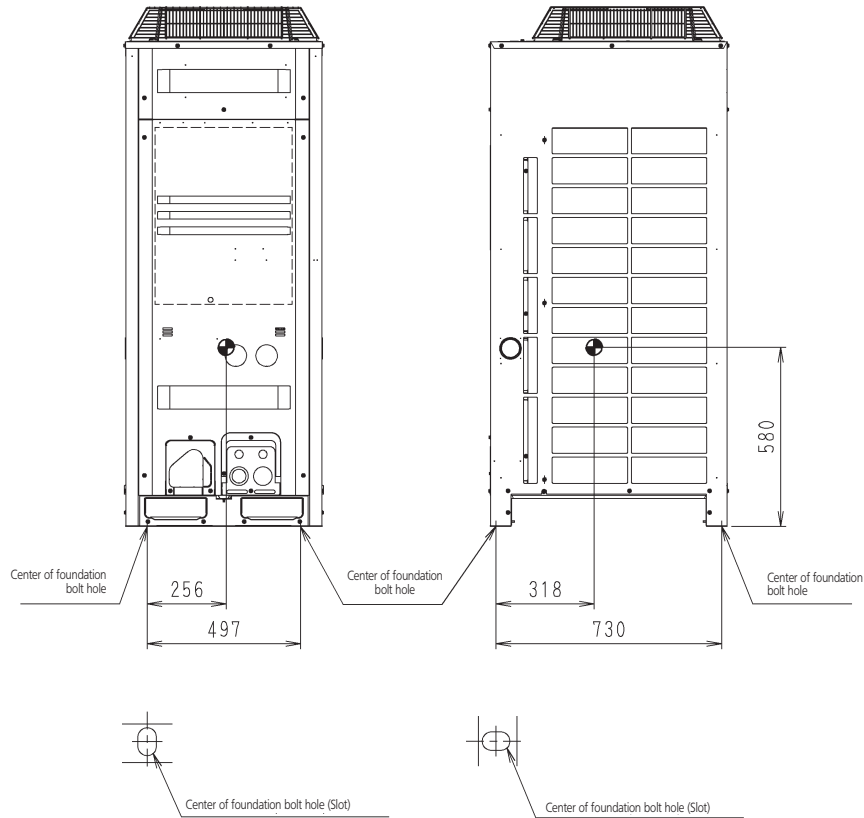

4D052145E

ERQ200AW1

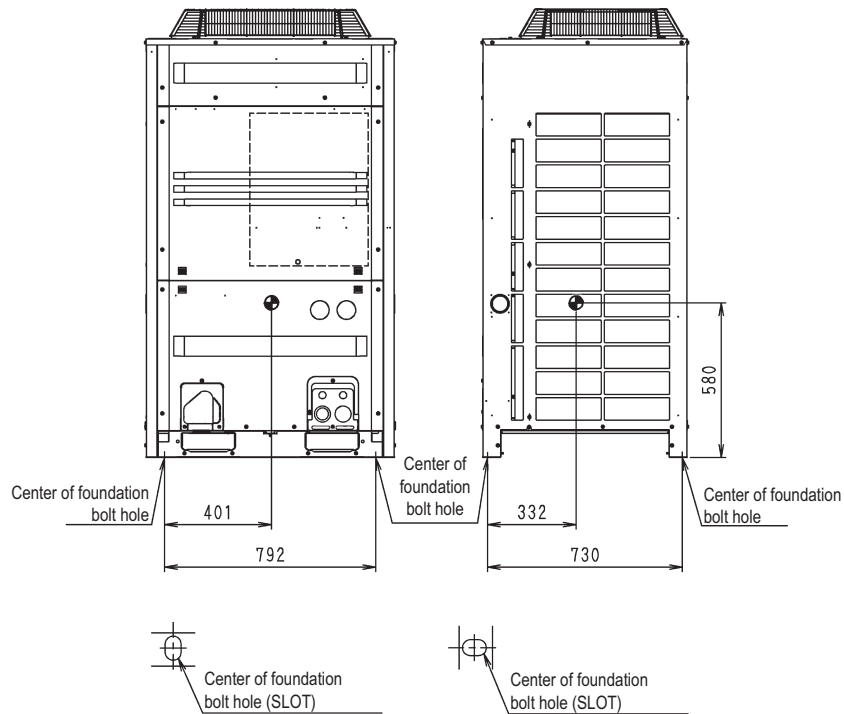

4D052146P

7 Centre of gravity

7 - 1 Centre of Gravity

ERQ250AW1

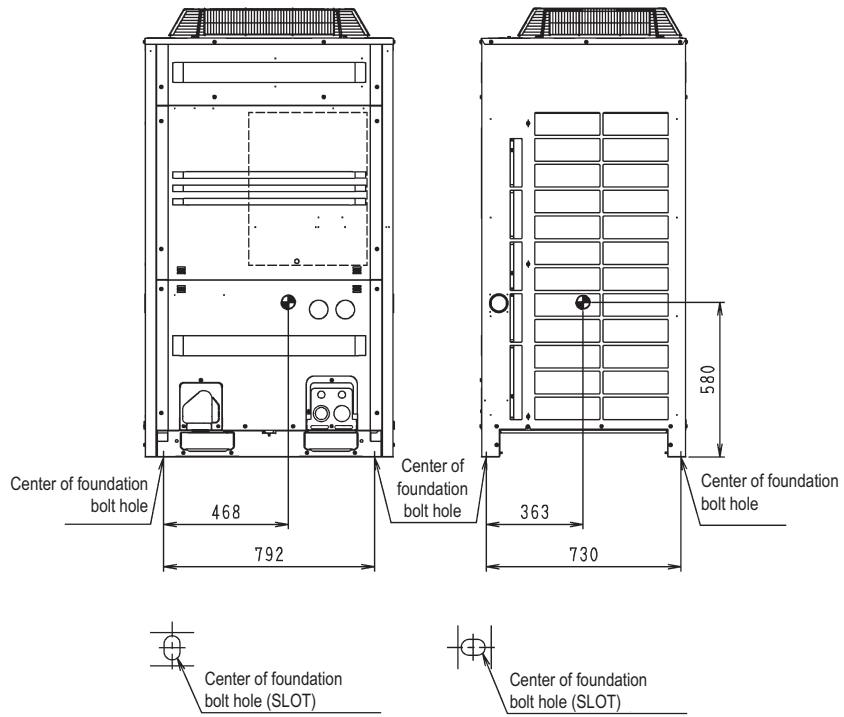

4D052147N

8 Piping diagrams

8 - 1 Piping Diagrams

8

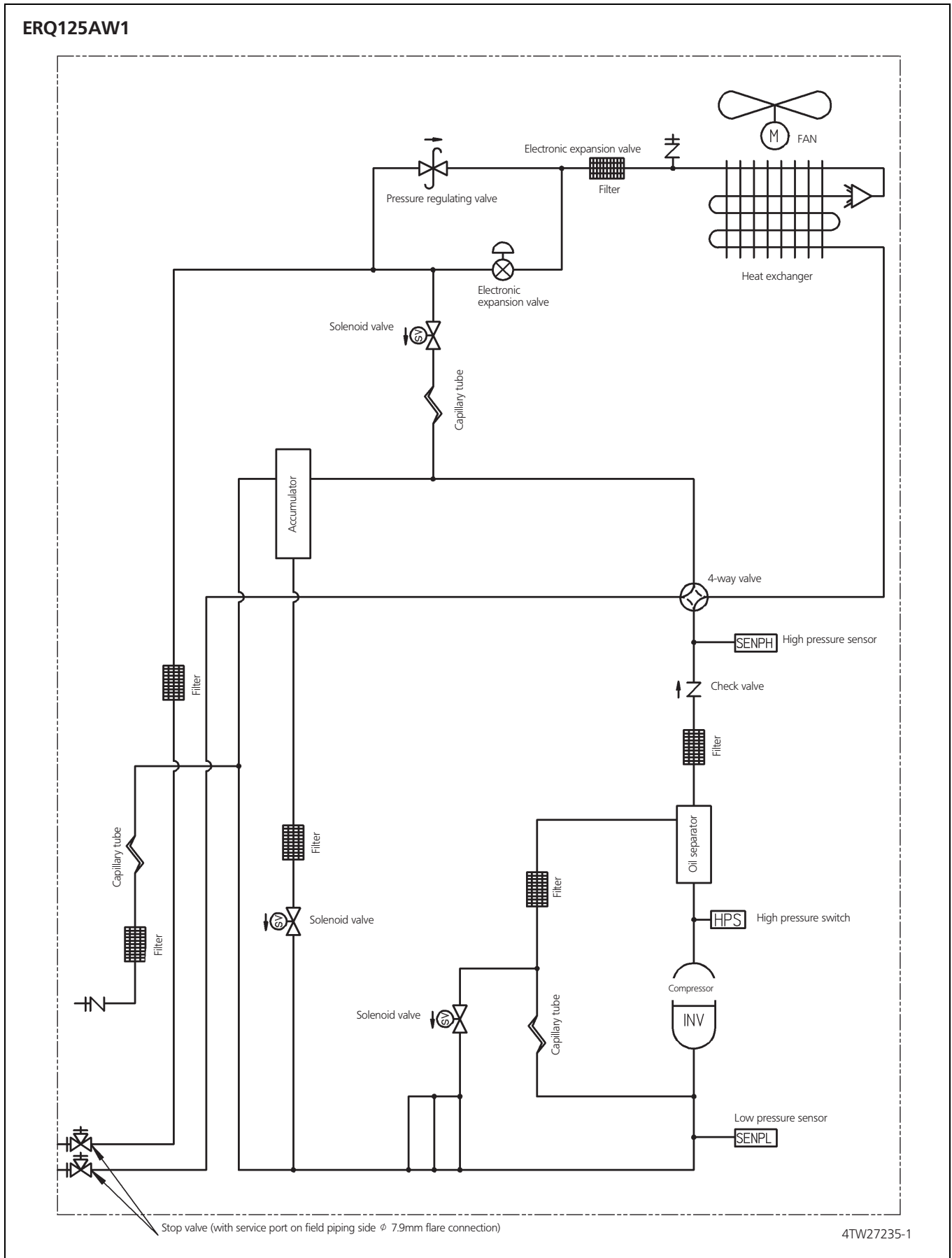

8 Piping diagrams

8 - 1 Piping Diagrams

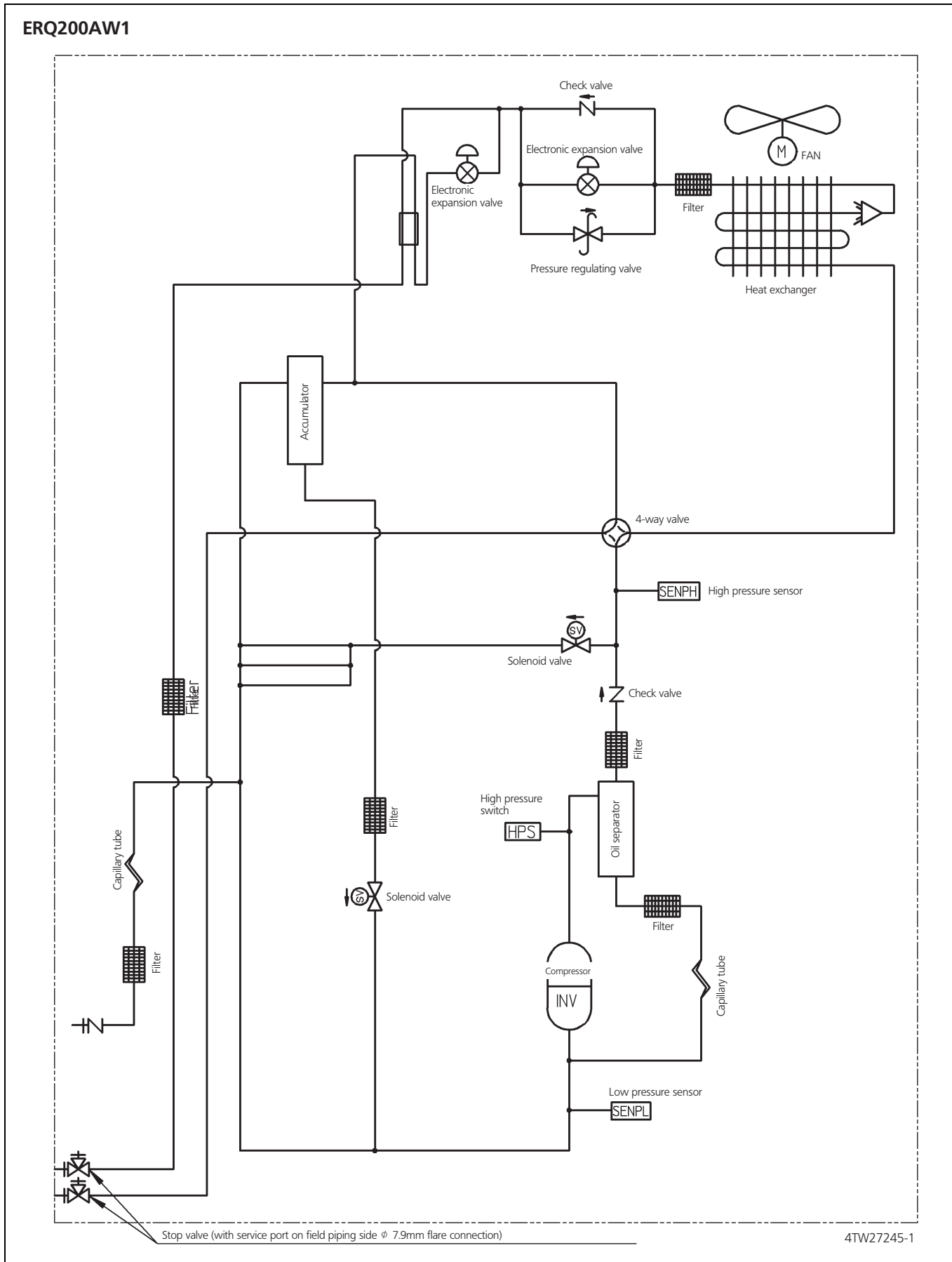

8 Piping diagrams

8 - 1 Piping Diagrams

8

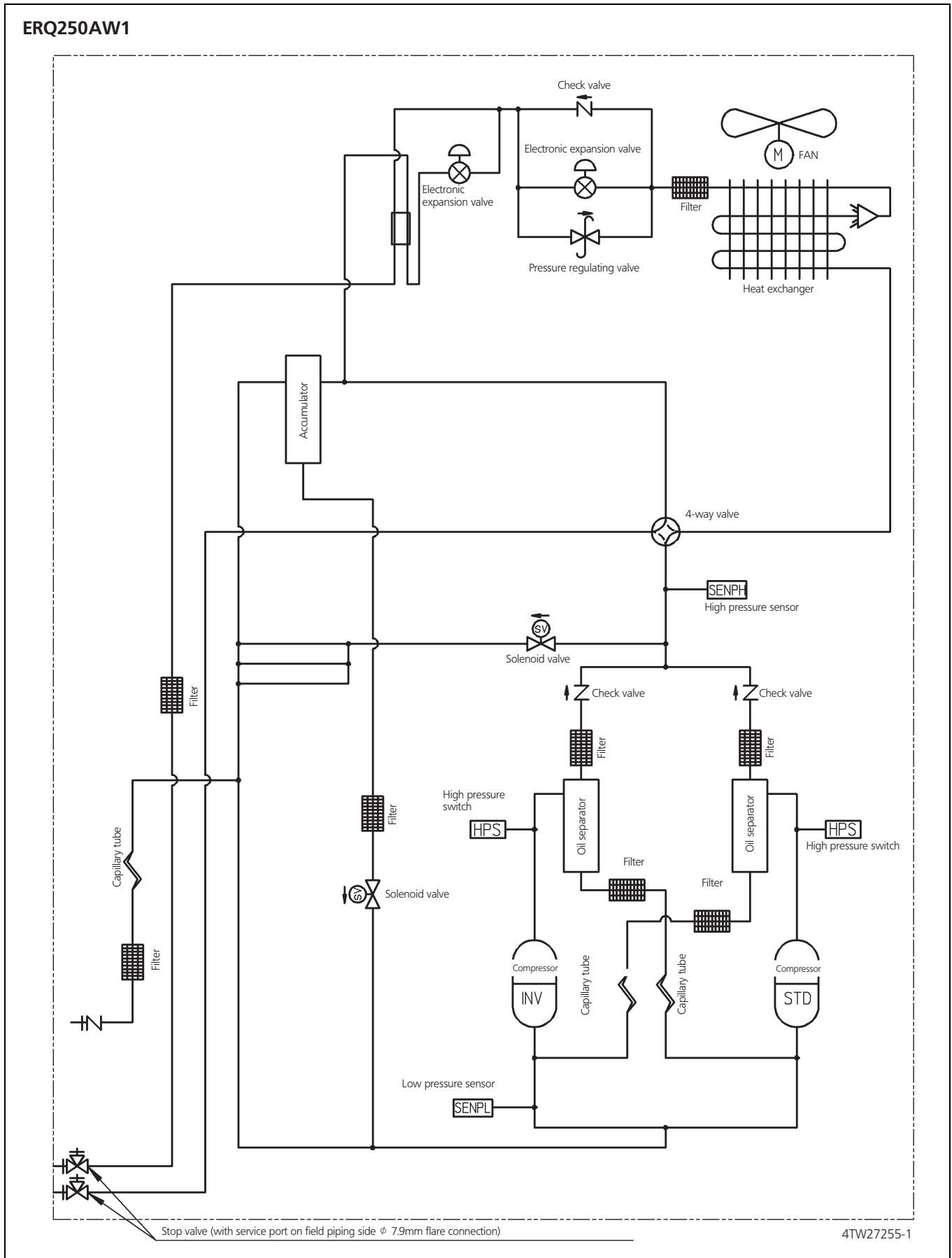

9 Wiring diagrams

9 - 1 Wiring Diagrams - Single Phase

ERQ125AW1

Position of M1C, M1F

Detail of M1C

F5U	Field fuse
F400U	Fuse (250V, 6.3A ⊕) (A2P)
H1P~H8P	Pilot lamp (service monitor-orange) [H2P] prepare, test -- flickering malfunction detection -- light up
HAP	Pilotlamp (service monitor-green)
K1R	Magnetic relay
K1M, K2M	Magnetic contactor (M1C)
K3R~K11R	K3R: Y1S K7R: E1HC K4R: Y2S K11R: Y4S K5R: Y3S
L1R	Reactor
M1C	Motor (compressor)
M1F	Motor (fan)
PS	Switching power supply (A1P, A3P)
Q1RP	Phase reversal detect circuit
Q1DI	Earth leakage breaker
R24	Resistor (current sensor) (A4P)
R1, R3	Resistor
R78	Resistor (current limiting)
R1T~R6T	Thermistor R1T: air (A1P) R4T: heat exch. deicer R2T: suction R5T: liquid pipe R3T: M1C discharge R6T: accumulator
S1NPH	Pressure sensor (high)
S1NPL	Pressure sensor (low)
S1PH	Pressure switch (high)
SD1	Safety devices input
V1R	Power module (A4P)
V1P	Power module (A3P)
X1A, 2A	Connector (M1F)
X1M	Terminal strip (power supply)
X1M	Terminal strip (control) (A1P)
X1M	Terminal strip (A5P)
Y1E	Electronic expansion valve (main)
Y1S~Y4S	Solenoid valve Y1S: hot gas Y3S: 4 way valve Y2S: oil return Y4S: injection
Z1C~Z6C	Noise filter (Ferrite core)
Z1F	Noise filter (with surge absorber)
Cool/heat selector	
S1S	Selector switch (fan/cool-heat)
S2S	Selector switch (cool-heat)

NOTES

- This wiring diagram only applies to the outdoor unit.
- : field wiring, ---: indication of parts outside switchbox
- : terminal strip, ⊙: connector, ○: terminal, ⊕: protective earth (screw)
- When using the option adapter, refer to the installation manual.
- Refer to the installation manual, for connection wiring to indoor-outdoor transmission F1-F2 and on how to use BS1-BS5 and DS1, DS2 switch.
- Do not operate the unit by short-circuiting protection device S1PH.
- BLK: black, RED: red, BLU: blue, WHT: white, PNK: pink, YLW: yellow, BRN: brown, GRY: grey, GRN: green, ORG: orange.

A1P~5P	Printed circuit board
A1P: Main	A4P: Fan
A2P: Noise filter	A5P: ABC I/P
A3P: Inverter	
BS1-BS5	Push button switch (mode, set, return, test, reset)
C1	Capacitor
C32, C66	Capacitor
DS1, DS2	Dip switch
E1HC	Crankcase heater
F101U	Fuse (A4P)
F1U, F2U	Fuse (250V, 3.15A ⊕) (A1P)

2TW32036-1A

9 Wiring diagrams

9 - 1 Wiring Diagrams - Single Phase

9

ERQ200AW1

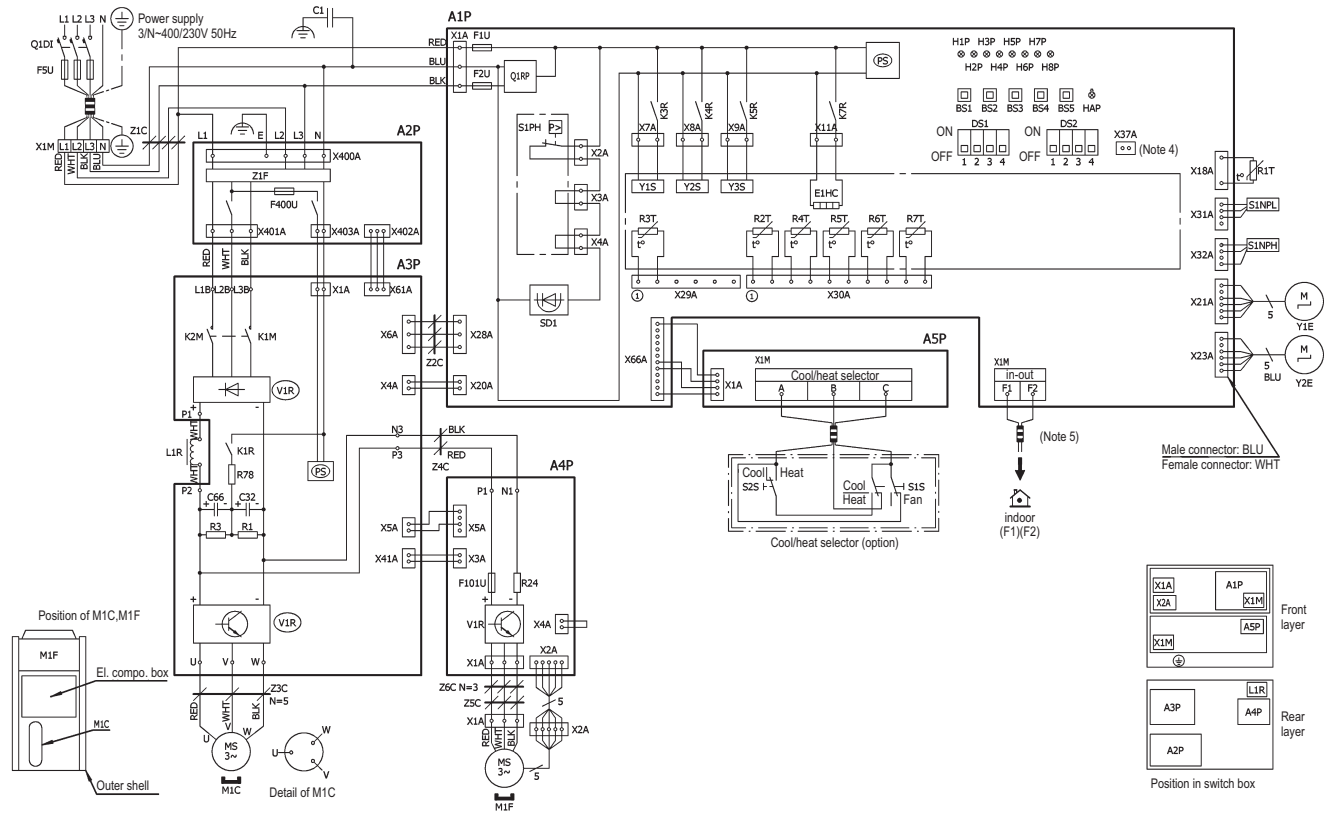

A1P~A5P	Printed circuit board		R1,R3	Resistor
	A1P: Main	A4P: Fan	R78	Resistor (current limiting)
BS1~BS5	Push Button Switch (mode, set, return, test, reset)		R1T~R7T	Thermistor
				R1T: Air (A1P) R4T: Heat exch. deicer R2T: Suction R5T: Heat exch. outlet R3T: M1C discharge R6T: Liquid pipe R7T: Accumulator
C1	Capacitor		S1NPH	Pressure sensor (high)
C32,C66	Capacitor		S1NPL	Pressure sensor (low)
DS1,DS2	DIP switch		S1PH	Pressure switch (high)
E1HC	Crankcase heater		SD1	Safety devices input
F101U	Fuse (A4P)		V1R	Power module (A4P)
F1U,F2U	Fuse (250V, 3.15AⓄ) (A1P)		V1R	Power module (A3P)
F5U	Field fuse		X1A,X2A	Connector (M1F)
F400U	Fuse (250V, 6.3AⓄ) (A2P)		X1M	Terminal strip (power supply)
H1P~H8P	Pilotlamp (Service monitor - orange) [H2P] Prepare, test- - - - - flickering Malfunction detection- - light up		X1M	Terminal strip (control)(A1P)
			X1M	Terminal strip(A5P)
HAP	Pilotlamp (service monitor - green)		Y1E	Electronic expansion valve (main)
K1R	Magnetic relay		Y2E	Electronic expansion valve (subcool)
K1M,K2M	Magnetic contactor (M1C)		Y1S~Y3S	Solenoid valve
K3R~K7R	K3R: Y1S K5R: Y3S K4R: Y2S K7R: E1HC		Y1S	Hot gas
			Y3S	4 way valve
L1R	Reactor		Z1C~6C	Noise filter (ferrite core)
M1C	Motor (compressor)		Z1F	Noise filter (with surge absorber)
M1F	Motor (fan)			
PS	Switching power supply (A1P,A3P)			Cool/heat selector
Q1RP	Phase reversal detect circuit		S1S	Selector switch (fan/cool - heat)
Q1DI	Earth leakage breaker		S2S	Selector switch (cool - heat)
R24	Resistor (current sensor) (A4P)			

NOTES

- This wiring diagram only applies to the outdoor unit.
- - [] : field wiring, [] : indication of parts outside switchbox.
- [] : terminal strip, [] : connector, ○ : terminal, ⊕ : protective earth (screw).
- When using the option adapter, refer to the installation manual.
- Refer to the installation manual, for connection wiring to indoor-outdoor transmission F1 - F2 and on how to use BS1~BS5 and DS1, DS2 switch.
- Do not operate the unit by short-circuiting protection device S1PH.
- BLK: black, RED: red, BLU: blue, WHT: white, PNK: pink, YLW: yellow, BRN: brown, GRY: grey, GRN: green, ORG: orange.

9 Wiring diagrams

9 - 1 Wiring Diagrams - Single Phase

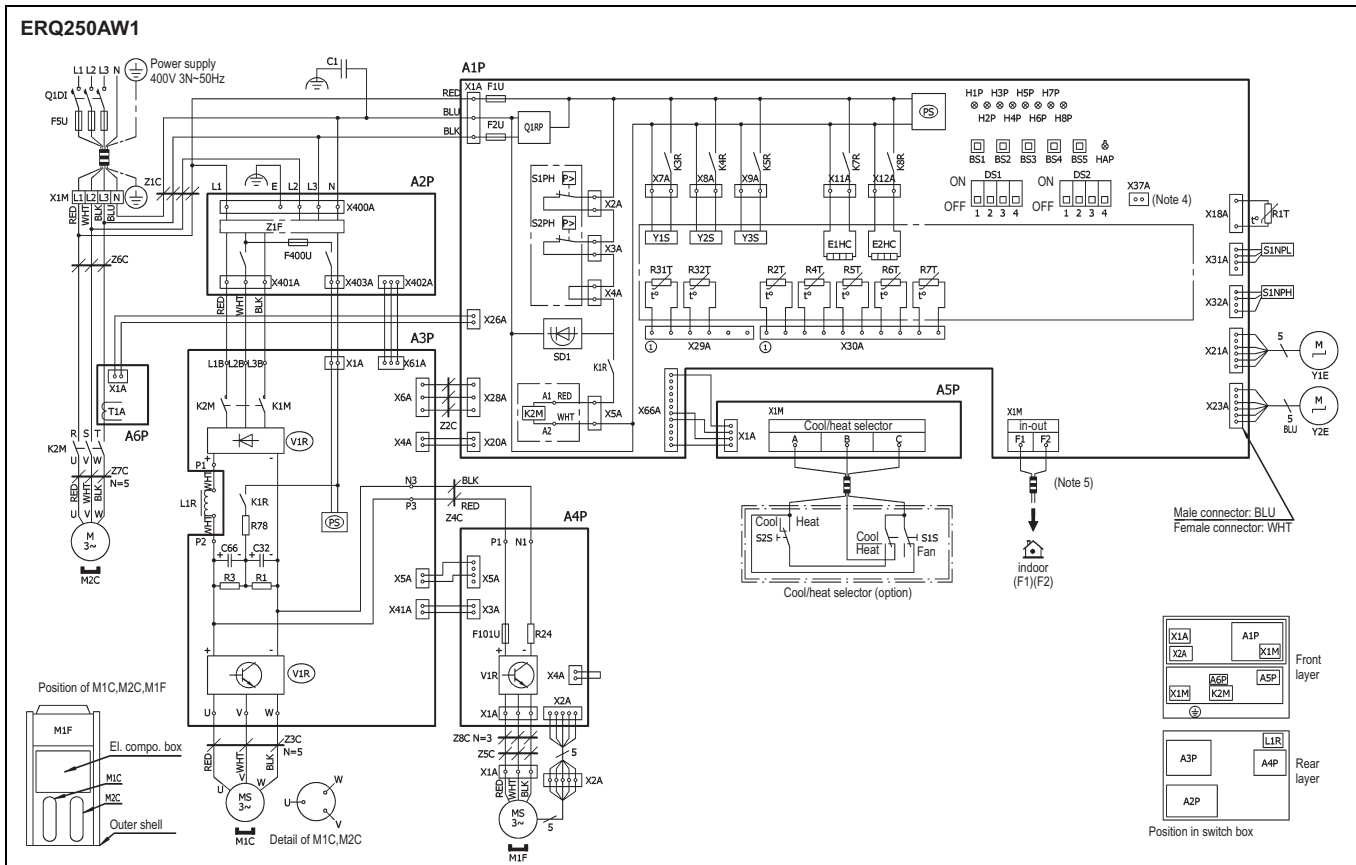

A1P~A6P	Printed circuit board		Q1D1	Earth leakage breaker
	A1P: Main	A4P: Fan	R24	Resistor (current sensor) (A4P)
	A2P: Noise Filter	A5P: ABC I/P	R1,R3	Resistor
	A3P: Inverter	A6P: Current Sensor	R78	Resistor (current limiting)
BS1~BS5	Push Button Switch (mode, set, return, test, reset)		R1T~R7T	Thermistor
C1	Capacitor		R31T,R32T	R1T: Air (A1P) R4T: Heat exch. deicer
C32,C66	Capacitor			R2T: Suction R5T: Heat exch. outlet
DS1,DS2	DIP switch			R31T: M1C discharge R6T: Liquid pipe
E1HC,E2HC	Crankcase heater			R32T: M2C discharge R7T: Accumulator
F101U	Fuse (A4P)		S1NPH	Pressure sensor (high)
F1U,F2U	Fuse (250V, 3.15A) (A1P)		S1NPL	Pressure sensor (low)
F5U	Field fuse		S1PH,S2PH	Pressure switch (high)
F400U	Fuse (250V, 6.3A) (A2P)		T1A	Current sensor (A6P)
H1P~H8P	Pilotlamp (Service monitor - orange) [H2P] Prepare, test - - - - - flickering Malfunction detection - - -light up		SD1	Safety devices input
HAP	Pilotlamp (service monitor - green)		V1R	Power module (A4P)
K1R	Magnetic relay		V1R	Power module (A3P)
K1M,K2M	Magnetic contactor (M1C)		X1A,X2A	Connector (M1F)
K2M	Magnetic contactor (M2C)		X1M	Terminal strip (power supply)
K1R	Magnetic relays (K2M)		X1M	Terminal strip (control)(A1P)
			X1M	Terminal strip(A5P)
K3R~K8R	K3R: Y1S K4R: Y2S K5R: Y3S	K7R: E1HC K8R: E2HC	Y1E	Electronic expansion valve (main)
			Y2E	Electronic expansion valve (subcool)
L1R	Reactor		Y1S~Y3S	Solenoid valve
M1C,M2C	Motor (compressor)			Y1S: Hot gas Y3S: 4 way valve
M1F	Motor (fan)		Z1C~Z8C	Noise filter (ferrite core)
PS	Switching power supply (A1P,A3P)		Z1F	Noise filter (with surge absorber)
Q1RP	Phase reversal detect circuit		S1S	Selector switch (fan/cool - heat)
			S2S	Selector switch (cool - heat)

- NOTES**
- This wiring diagram only applies to the outdoor unit.
 - :field wiring.
 - : terminal strip, □□□□: connector, ○-○-: terminal, ⊕: protective earth (screw).
 - When using the option adapter, refer to the installation manual.
 - Refer to the installation manual, for connection wiring to indoor-outdoor transmission F1 - F2 and on how to use BS1~BS5 and DS1, DS2 switch.
 - Do not operate the unit by short-circuiting protection device S1PH.
 - BLK: black, RED: red, BLU: blue, WHT: white, PNK: pink, YLW: yellow, BRN: brown, GRY: grey, GRN: green, ORG: orange.

10 External connection diagrams

10 - 1 External Connection Diagrams

10

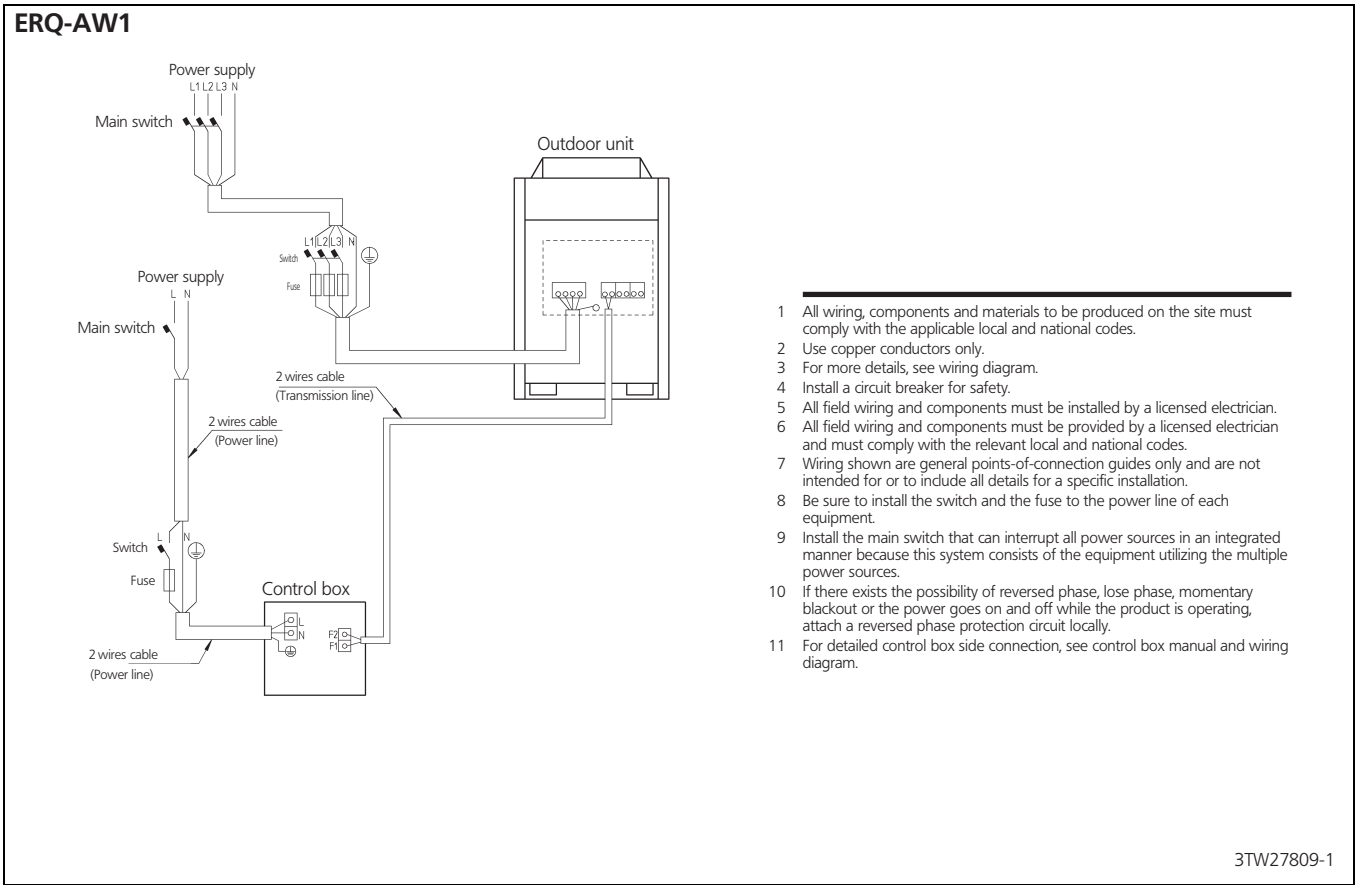

11 Sound data

11 - 1 Sound Power Spectrum

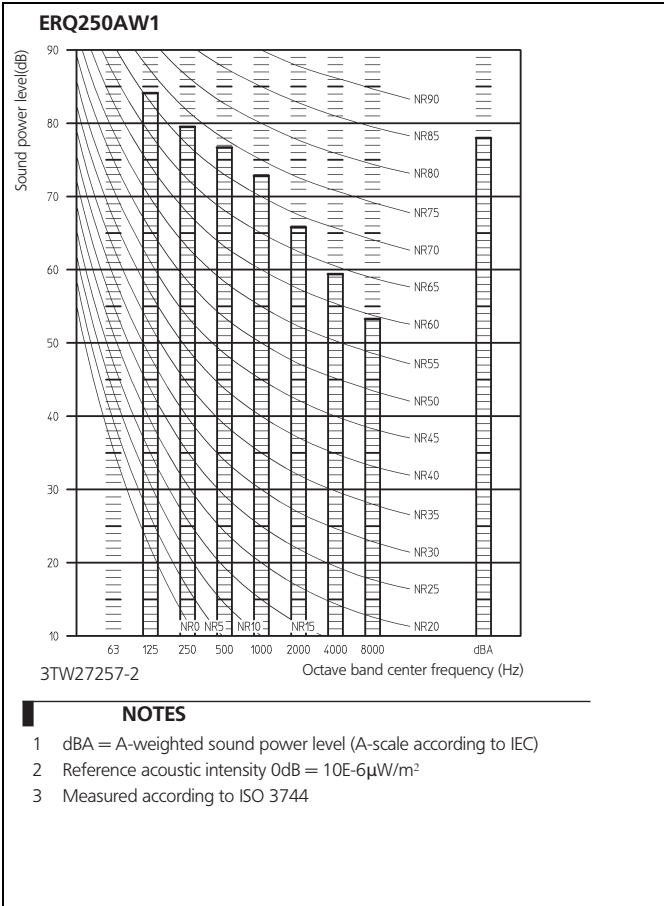
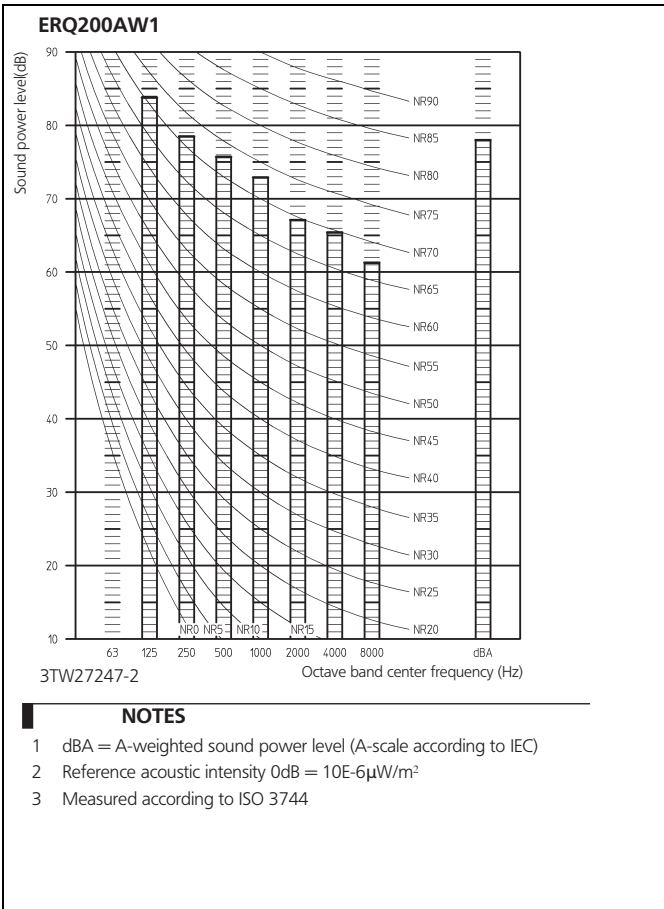
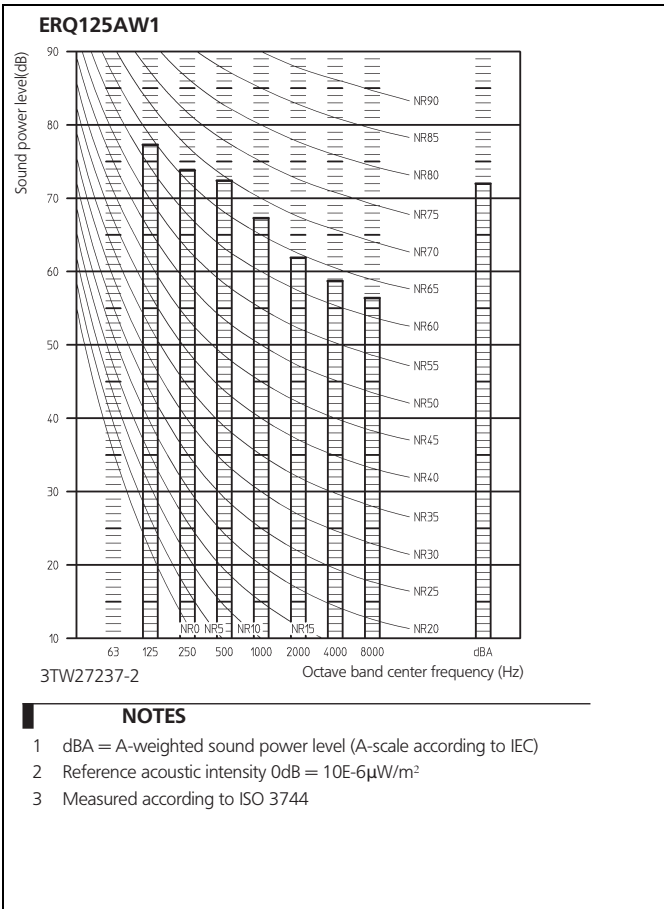

11 Sound data

11 - 2 Sound Pressure Spectrum

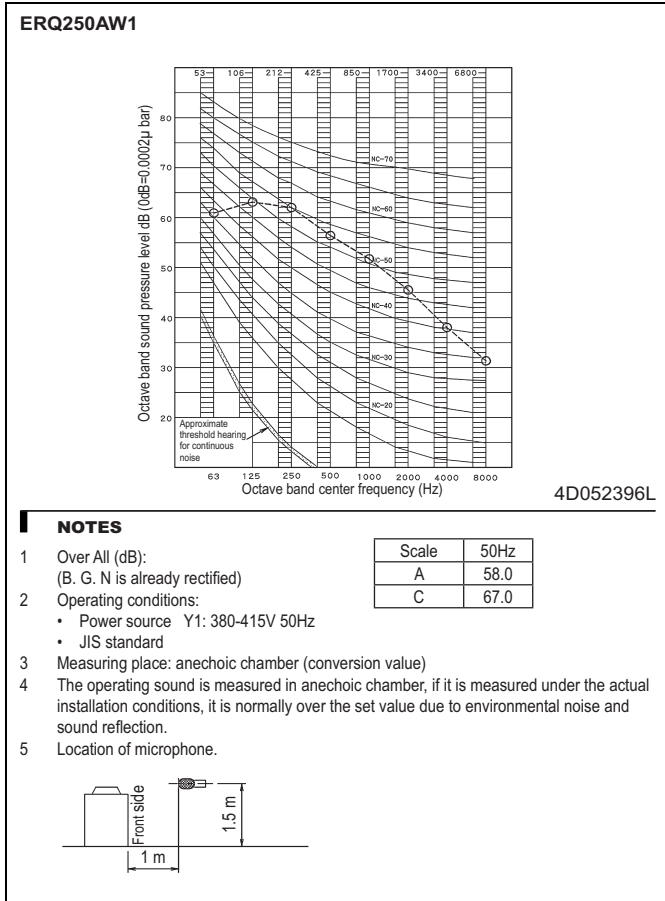
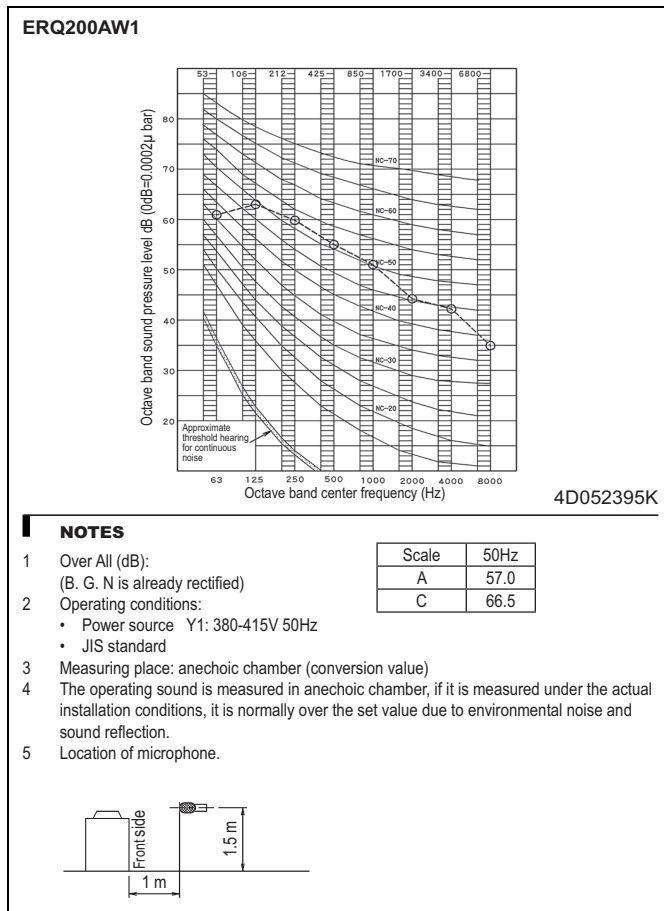
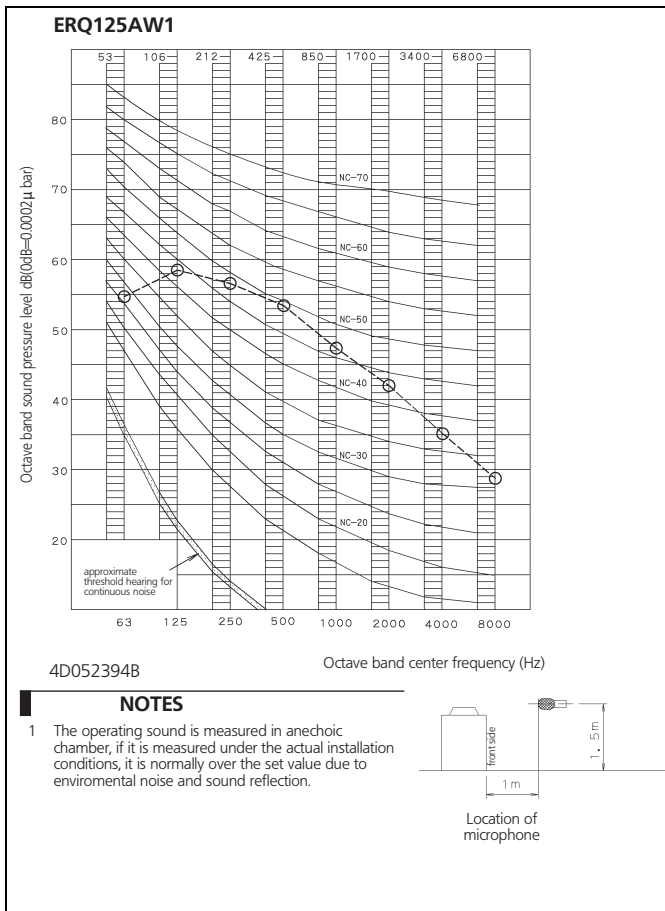

12 Installation

12 - 1 Installation Method

ERQ-AW1B

For single unit installation

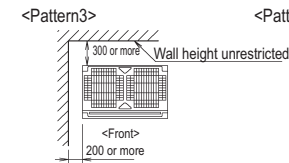
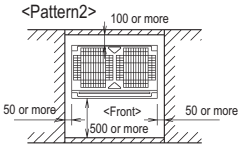
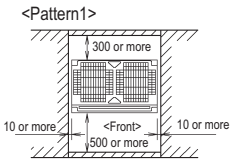

For installation in rows

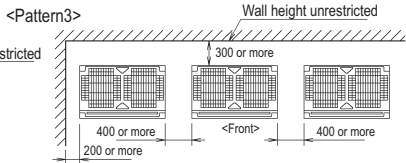
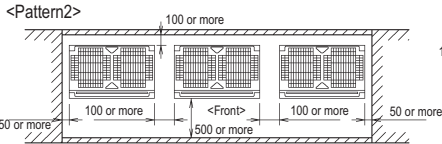
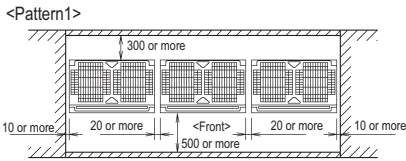

For centralized group layout

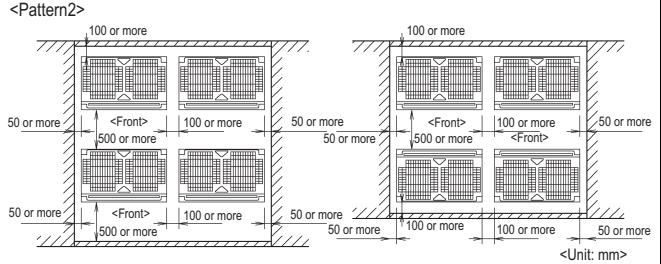
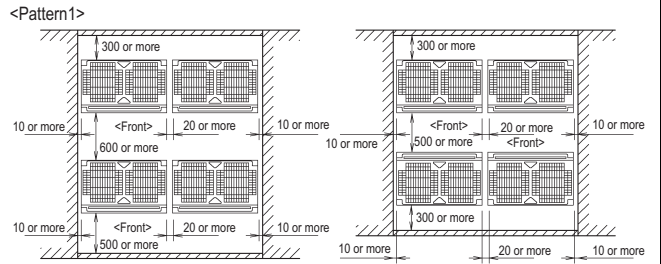

NOTES

- Heights of walls in case of Patterns 1 and 2:
Front: 1500mm
Suction side: 500mm
Side: Height unrestricted.
Installation space to be shown in this drawing is based on the cooling operation at 35 degrees outdoor air temperature. When the design outdoor air temperature exceeds 35 degrees or the load exceeds maximum ability because of much generation load of heat in all outdoor unit, take the suction side space more broadly than the space to be shown in this drawing.
- If the above wall heights are exceeded then h2/2 and h1/2 should be added to the front and suction side service spaces respectively as shown in the figure on the right.
- When installing the units most appropriate pattern should be selected from those shown above in order to obtain the best fit in the space available always bearing in mind the need to leave enough space for a person to pass between units and wall and for the air to circulate freely. (If more units are to be installed than are catered for in the above patterns your layout should take account of the possibility of short circuits.)
- The units should be installed to leave sufficient space at the front for the on site refrigerant piping work to be carried out comfortably.

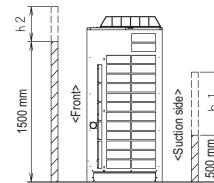

3D051451W

12 Installation

12 - 2 Fixation and Foundation of Units

12

ERQ-AW1

Foundation bolt
Type: JA
Size: M12
Four bolts are required
3 thread ridges or more

Foundation bolt executing method

Model	A	B
ERQ125A7W18	497	697
ERQ200A7W18	792	992
ERQ250A7W18	792	992

NOTES

- 1 The proportions of cement: sand: gravel for the concrete shall be 1:2:4, and the reinforcement bars that their diameter are 10mm, (approx. 300mm intervals) shall be placed.
- 2 The surface shall be finished with mortar. The corner edges shall be chamfered.
- 3 When the foundation is built on a concrete floor, rubble is not necessary. However, the surface of the section on which the foundation is built shall have rough finish.
- 4 A drain ditch shall be made around the foundation to thoroughly drain water from the equipment installation area.
- 5 When installing the equipment on a roof, the floor strength shall be checked, and water-proofing measures shall be taken.
- 6 Y Ditch is not necessary for 125 models.

3TW32039-6

13 Operation range

13 - 1 Operation Range

ERQ-AW1

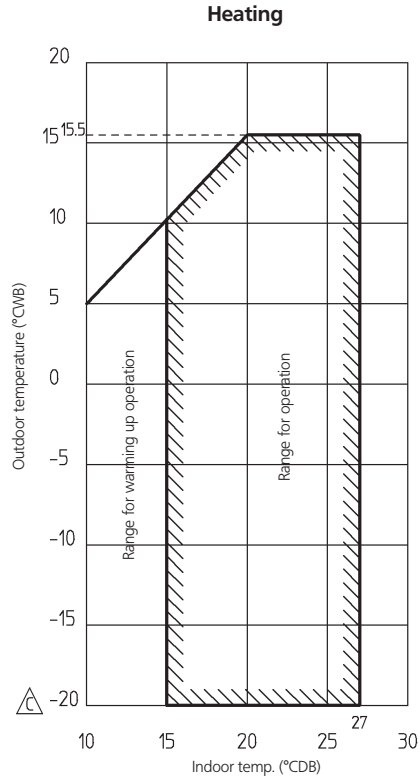
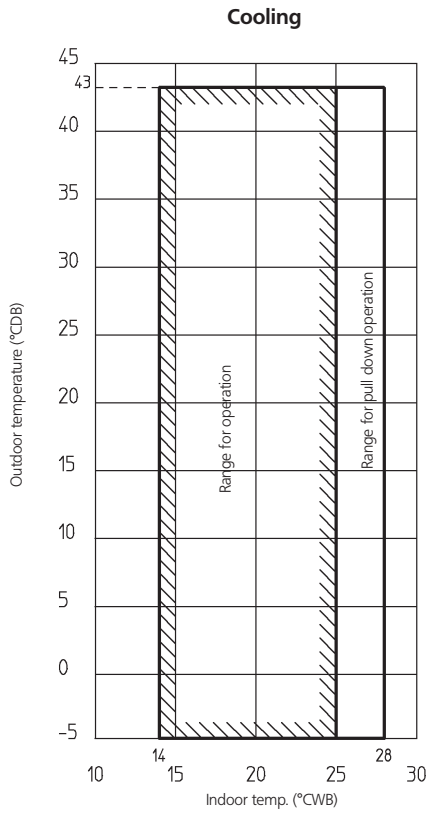

NOTES

1 These figures assume the following operating conditions.

- Indoor and outdoor units:
- Equivalent piping length 7.5m
 - Level difference 0m

2 Depending on operation and installation conditions, the indoor unit can change over to freeze-up operation (indoor de-icing).

3 To reduce the freeze-up operation (indoor de-icing) frequency it is recommended to install the outdoor unit in a location not exposed to wind.

4TW25797-3C



Daikin Europe N.V. Naamloze Vennootschap - Zandvoordestraat 300, B-8400 Oostende - Belgium - www.daikin.eu - BE 0412 120 336 - RPR Oostende

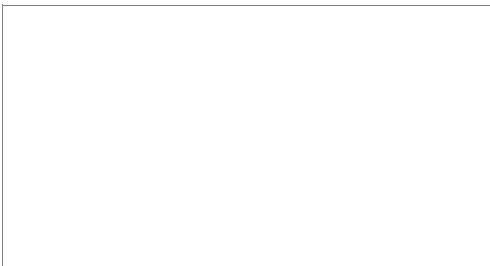

EEDEN 08/16



The present leaflet is drawn up by way of information only and does not constitute an offer binding upon Daikin Europe N.V.. Daikin Europe N.V. has compiled the content of this leaflet to the best of its knowledge. No express or implied warranty is given for the completeness, accuracy, reliability or fitness for particular purpose of its content and the products and services presented therein. Specifications are subject to change without prior notice. Daikin Europe N.V. explicitly rejects any liability for any direct or indirect damage, in the broadest sense, arising from or related to the use and/or interpretation of this leaflet. All content is copyrighted by Daikin Europe N.V.