

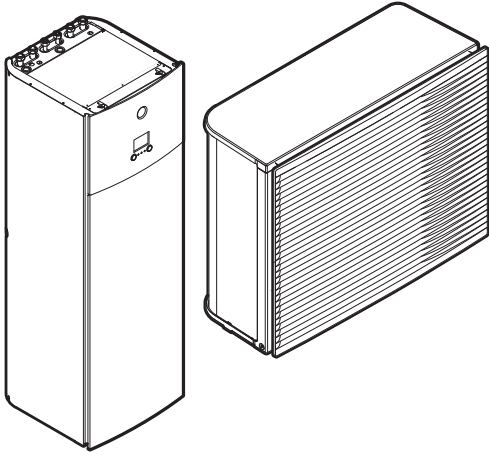

Installer reference guide

Daikin Altherma 3 H HT F



<https://daikintechnicaldatahub.eu>



EPRA14DAV3
EPRA16DAV3
EPRA18DAV3

EPRA14DAW1
EPRA16DAW1
EPRA18DAW1

ETVH16S18DA6V(G)
ETVH16S23DA6V(G)
ETVH16S18DA9W(G)
ETVH16S23DA9W(G)
ETVX16S18DA6V(G)
ETVX16S23DA6V(G)
ETVX16S18DA9W(G)
ETVX16S23DA9W(G)

Table of contents

1	General safety precautions	6
1.1	About the documentation	6
1.1.1	Meaning of warnings and symbols	6
1.2	For the installer	7
1.2.1	General	7
1.2.2	Installation site	8
1.2.3	Refrigerant — in case of R410A or R32.....	9
1.2.4	Water.....	10
1.2.5	Electrical	11
2	About the documentation	13
2.1	About this document	13
2.2	Installer reference guide at a glance	14
3	About the box	16
3.1	Overview: About the box.....	16
3.2	Outdoor unit	16
3.2.1	To handle the outdoor unit.....	16
3.2.2	To unpack the outdoor unit	18
3.2.3	To remove the accessories from the outdoor unit.....	19
3.3	Indoor unit	20
3.3.1	To unpack the indoor unit.....	20
3.3.2	To remove the accessories from the indoor unit	20
3.3.3	To handle the indoor unit.....	20
4	About the units and options	21
4.1	Overview: About the units and options.....	21
4.2	Identification	21
4.2.1	Identification label: Outdoor unit	21
4.2.2	Identification label: Indoor unit	22
4.3	Combining units and options.....	22
4.3.1	Possible combinations of indoor unit and outdoor unit.....	22
4.3.2	Possible options for the outdoor unit.....	23
4.3.3	Possible options for the indoor unit.....	23
5	Application guidelines	26
5.1	Overview: Application guidelines	26
5.2	Setting up the space heating/cooling system	27
5.2.1	Single room	28
5.2.2	Multiple rooms – One LWT zone	32
5.2.3	Multiple rooms – Two LWT zones.....	36
5.3	Setting up an auxiliary heat source for space heating	39
5.4	Setting up the domestic hot water tank.....	42
5.4.1	System layout – Integrated DHW tank.....	42
5.4.2	Selecting the volume and desired temperature for the DHW tank	42
5.4.3	Setup and configuration – DHW tank	44
5.4.4	DHW pump for instant hot water	44
5.4.5	DHW pump for disinfection	45
5.5	Setting up the energy metering.....	45
5.5.1	Produced heat	46
5.5.2	Consumed energy.....	46
5.5.3	Normal kWh rate power supply.....	47
5.5.4	Preferential kWh rate power supply.....	48
5.6	Setting up the power consumption control	49
5.6.1	Permanent power limitation	49
5.6.2	Power limitation activated by digital inputs	50
5.6.3	Power limitation process.....	51
5.6.4	BBR16 power limitation.....	52
5.7	Setting up an external temperature sensor	52
6	Unit installation	54
6.1	Preparing the installation site.....	54
6.1.1	Installation site requirements of the outdoor unit.....	54
6.1.2	Additional installation site requirements of the outdoor unit in cold climates.....	57
6.1.3	Installation site requirements of the indoor unit	57
6.2	Opening and closing the units	58

6.2.1	About opening the units.....	58
6.2.2	To open the outdoor unit.....	58
6.2.3	To remove the transportation stay.....	59
6.2.4	To close the outdoor unit.....	59
6.2.5	To open the indoor unit.....	60
6.2.6	To lower the switch box on the indoor unit.....	62
6.2.7	To close the indoor unit.....	63
6.3	Mounting the outdoor unit.....	63
6.3.1	About mounting the outdoor unit.....	63
6.3.2	Precautions when mounting the outdoor unit.....	63
6.3.3	To provide the installation structure.....	63
6.3.4	To install the outdoor unit.....	64
6.3.5	To provide drainage.....	65
6.3.6	To install the discharge grille.....	67
6.3.7	To remove the discharge grille, and put the grille in safety position.....	68
6.4	Mounting the indoor unit.....	70
6.4.1	About mounting the indoor unit.....	70
6.4.2	Precautions when mounting the indoor unit.....	70
6.4.3	To install the indoor unit.....	70
6.4.4	To connect the drain hose to the drain.....	71
7	Piping installation	73
7.1	Preparing water piping.....	73
7.1.1	Water circuit requirements.....	73
7.1.2	Formula to calculate the expansion vessel pre-pressure.....	75
7.1.3	To check the water volume and flow rate.....	75
7.1.4	Changing the pre-pressure of the expansion vessel.....	78
7.1.5	To check the water volume: Examples.....	78
7.2	Connecting water piping.....	79
7.2.1	About connecting the water piping.....	79
7.2.2	Precautions when connecting the water piping.....	79
7.2.3	To connect the water piping.....	79
7.2.4	To connect the recirculation piping.....	82
7.2.5	To fill the water circuit.....	82
7.2.6	To protect the water circuit against freezing.....	82
7.2.7	To fill the domestic hot water tank.....	85
7.2.8	To insulate the water piping.....	86
8	Electrical installation	87
8.1	About connecting the electrical wiring.....	87
8.1.1	Precautions when connecting the electrical wiring.....	87
8.1.2	Guidelines when connecting the electrical wiring.....	88
8.1.3	About electrical compliance.....	89
8.1.4	About preferential kWh rate power supply.....	89
8.1.5	Overview of electrical connections except external actuators.....	90
8.2	Connections to the outdoor unit.....	91
8.2.1	To connect the electrical wiring to the outdoor unit.....	91
8.2.2	To reposition the air thermistor on the outdoor unit.....	97
8.3	Connections to the indoor unit.....	98
8.3.1	To connect the main power supply.....	101
8.3.2	To connect the backup heater power supply.....	103
8.3.3	To connect the shut-off valve.....	105
8.3.4	To connect the electricity meters.....	106
8.3.5	To connect the domestic hot water pump.....	107
8.3.6	To connect the alarm output.....	108
8.3.7	To connect the space cooling/heating ON/OFF output.....	109
8.3.8	To connect the changeover to external heat source.....	110
8.3.9	To connect the power consumption digital inputs.....	111
8.3.10	To connect the safety thermostat (normally closed contact).....	112
8.4	After connecting the electrical wiring to the indoor unit.....	113
9	Configuration	115
9.1	Overview: Configuration.....	115
9.1.1	To access the most used commands.....	116
9.2	Configuration wizard.....	118
9.3	Possible screens.....	119
9.3.1	Possible screens: Overview.....	119
9.3.2	Home screen.....	120
9.3.3	Main menu screen.....	123
9.3.4	Menu screen.....	124

9.3.5	Setpoint screen.....	124
9.3.6	Detailed screen with values	125
9.3.7	Schedule screen: Example.....	125
9.4	Weather-dependent curve.....	130
9.4.1	What is a weather-dependent curve?	130
9.4.2	2-points curve.....	130
9.4.3	Slope-offset curve.....	131
9.4.4	Using weather-dependent curves.....	133
9.5	Settings menu	135
9.5.1	Malfunctioning	135
9.5.2	Room.....	135
9.5.3	Main zone	139
9.5.4	Additional zone.....	149
9.5.5	Space heating/cooling	155
9.5.6	Tank.....	163
9.5.7	User settings.....	170
9.5.8	Information.....	175
9.5.9	Installer settings	176
9.5.10	Commissioning	194
9.5.11	Operation.....	194
9.5.12	WLAN	195
9.6	Menu structure: Overview user settings.....	197
9.7	Menu structure: Overview installer settings.....	198
10	Commissioning	199
10.1	Overview: Commissioning	199
10.2	Precautions when commissioning	200
10.3	Checklist before commissioning.....	200
10.4	Checklist during commissioning	201
10.4.1	Minimum flow rate.....	201
10.4.2	Air purge function.....	202
10.4.3	Operation test run	203
10.4.4	Actuator test run	204
10.4.5	Underfloor heating screed dryout	205
11	Hand-over to the user	209
12	Maintenance and service	210
12.1	Overview: Maintenance and service.....	210
12.2	Maintenance safety precautions.....	210
12.3	Yearly maintenance	211
12.3.1	Yearly maintenance outdoor unit: overview	211
12.3.2	Yearly maintenance outdoor unit: instructions.....	211
12.3.3	Yearly maintenance indoor unit: overview	211
12.3.4	Yearly maintenance indoor unit: instructions	211
12.4	To drain the domestic hot water tank.....	214
12.5	About cleaning the water filter in case of trouble	214
12.5.1	To remove the water filter	215
12.5.2	To clean the water filter in case of trouble.....	215
12.5.3	To install the water filter	216
13	Troubleshooting	218
13.1	Overview: Troubleshooting	218
13.2	Precautions when troubleshooting	218
13.3	Solving problems based on symptoms.....	219
13.3.1	Symptom: The unit is NOT heating or cooling as expected.....	219
13.3.2	Symptom: Hot water does NOT reach the desired temperature.....	220
13.3.3	Symptom: The compressor does NOT start (space heating or domestic water heating)	220
13.3.4	Symptom: The system is making gurgling noises after commissioning	220
13.3.5	Symptom: The pump is blocked.....	221
13.3.6	Symptom: The pump is making noise (cavitation).....	221
13.3.7	Symptom: The pressure relief valve opens.....	222
13.3.8	Symptom: The water pressure relief valve leaks	222
13.3.9	Symptom: The space is NOT sufficiently heated at low outdoor temperatures.....	223
13.3.10	Symptom: The pressure at the tapping point is temporarily unusually high	224
13.3.11	Symptom: Tank disinfection function is NOT completed correctly (AH-error).....	224
13.4	Solving problems based on error codes	224
13.4.1	To display the help text in case of a malfunction	225
13.4.2	Error codes: Overview.....	225
14	Disposal	230

14.1	To recover refrigerant.....	230
15	Technical data	232
15.1	Service space: Outdoor unit	233
15.2	Piping diagram: Outdoor unit	234
15.3	Piping diagram: Indoor unit	235
15.4	Wiring diagram: Outdoor unit	236
15.5	Wiring diagram: Indoor unit	241
16	Glossary	247
17	Field settings table	248

1 General safety precautions

In this chapter

1.1	About the documentation.....	6
1.1.1	Meaning of warnings and symbols.....	6
1.2	For the installer.....	7
1.2.1	General.....	7
1.2.2	Installation site.....	8
1.2.3	Refrigerant — in case of R410A or R32.....	9
1.2.4	Water.....	10
1.2.5	Electrical.....	11

1.1 About the documentation

- The original documentation is written in English. All other languages are translations.
- The precautions described in this document cover very important topics, follow them carefully.
- The installation of the system, and all activities described in the installation manual and in the installer reference guide **MUST** be performed by an authorised installer.

1.1.1 Meaning of warnings and symbols

	DANGER Indicates a situation that results in death or serious injury.
	DANGER: RISK OF ELECTROCUTION Indicates a situation that could result in electrocution.
	DANGER: RISK OF BURNING/SCALDING Indicates a situation that could result in burning/scalding because of extreme hot or cold temperatures.
	DANGER: RISK OF EXPLOSION Indicates a situation that could result in explosion.
	WARNING Indicates a situation that could result in death or serious injury.
	WARNING: FLAMMABLE MATERIAL
	CAUTION Indicates a situation that could result in minor or moderate injury.

**NOTICE**

Indicates a situation that could result in equipment or property damage.

**INFORMATION**

Indicates useful tips or additional information.

Symbols used on the unit:

Symbol	Explanation
	Before installation, read the installation and operation manual, and the wiring instruction sheet.
	Before performing maintenance and service tasks, read the service manual.
	For more information, see the installer and user reference guide.
	The unit contains rotating parts. Be careful when servicing or inspecting the unit.

Symbols used in the documentation:

Symbol	Explanation
	Indicates a figure title or a reference to it. Example: "▲ 1-3 Figure title" means "Figure 3 in chapter 1".
	Indicates a table title or a reference to it. Example: "■ 1-3 Table title" means "Table 3 in chapter 1".

1.2 For the installer

1.2.1 General

If you are NOT sure how to install or operate the unit, contact your dealer.

**DANGER: RISK OF BURNING/SCALDING**

- Do NOT touch the refrigerant piping, water piping or internal parts during and immediately after operation. It could be too hot or too cold. Give it time to return to normal temperature. If you must touch it, wear protective gloves.
- Do NOT touch any accidental leaking refrigerant.

**WARNING**

Improper installation or attachment of equipment or accessories could result in electrical shock, short-circuit, leaks, fire or other damage to the equipment. Only use accessories, optional equipment and spare parts made or approved by Daikin.

**WARNING**

Make sure installation, testing and applied materials comply with applicable legislation (on top of the instructions described in the Daikin documentation).



CAUTION

Wear adequate personal protective equipment (protective gloves, safety glasses,...) when installing, maintaining or servicing the system.



WARNING

Tear apart and throw away plastic packaging bags so that nobody, especially children, can play with them. Possible risk: suffocation.



WARNING

Provide adequate measures to prevent that the unit can be used as a shelter by small animals. Small animals that make contact with electrical parts can cause malfunctions, smoke or fire.



CAUTION

Do NOT touch the air inlet or aluminium fins of the unit.



CAUTION

- Do NOT place any objects or equipment on top of the unit.
- Do NOT sit, climb or stand on the unit.



NOTICE

Works executed on the outdoor unit are best done under dry weather conditions to avoid water ingress.

In accordance with the applicable legislation, it might be necessary to provide a logbook with the product containing at least: information on maintenance, repair work, results of tests, stand-by periods,...

Also, at least, following information MUST be provided at an accessible place at the product:

- Instructions for shutting down the system in case of an emergency
- Name and address of fire department, police and hospital
- Name, address and day and night telephone numbers for obtaining service

In Europe, EN378 provides the necessary guidance for this logbook.

1.2.2 Installation site

- Provide sufficient space around the unit for servicing and air circulation.
- Make sure the installation site withstands the weight and vibration of the unit.
- Make sure the area is well ventilated. Do NOT block any ventilation openings.
- Make sure the unit is level.

Do NOT install the unit in the following places:

- In potentially explosive atmospheres.
- In places where there is machinery that emits electromagnetic waves. Electromagnetic waves may disturb the control system, and cause malfunction of the equipment.
- In places where there is a risk of fire due to the leakage of flammable gases (example: thinner or gasoline), carbon fibre, ignitable dust.

- In places where corrosive gas (example: sulphurous acid gas) is produced. Corrosion of copper pipes or soldered parts may cause the refrigerant to leak.

1.2.3 Refrigerant — in case of R410A or R32

If applicable. See the installation manual or installer reference guide of your application for more information.



NOTICE

Make sure refrigerant piping installation complies with applicable legislation. In Europe, EN378 is the applicable standard.



NOTICE

Make sure the field piping and connections are NOT subjected to stress.



WARNING

During tests, NEVER pressurize the product with a pressure higher than the maximum allowable pressure (as indicated on the nameplate of the unit).



WARNING

Take sufficient precautions in case of refrigerant leakage. If refrigerant gas leaks, ventilate the area immediately. Possible risks:

- Excessive refrigerant concentrations in a closed room can lead to oxygen deficiency.
- Toxic gas might be produced if refrigerant gas comes into contact with fire.



DANGER: RISK OF EXPLOSION

Pump down – Refrigerant leakage. If you want to pump down the system, and there is a leak in the refrigerant circuit:

- Do NOT use the unit's automatic pump down function, with which you can collect all refrigerant from the system into the outdoor unit. **Possible consequence:** Self-combustion and explosion of the compressor because of air going into the operating compressor.
- Use a separate recovery system so that the unit's compressor does NOT have to operate.



WARNING

ALWAYS recover the refrigerant. Do NOT release them directly into the environment. Use a vacuum pump to evacuate the installation.



NOTICE

After all the piping has been connected, make sure there is no gas leak. Use nitrogen to perform a gas leak detection.



NOTICE

- To avoid compressor breakdown, do NOT charge more than the specified amount of refrigerant.
- When the refrigerant system is to be opened, refrigerant MUST be treated according to the applicable legislation.





WARNING

Make sure there is no oxygen in the system. Refrigerant may only be charged after performing the leak test and the vacuum drying.

Possible consequence: Self-combustion and explosion of the compressor because of oxygen going into the operating compressor.

- In case recharge is required, see the nameplate of the unit. It states the type of refrigerant and necessary amount.
- The unit is factory charged with refrigerant and depending on pipe sizes and pipe lengths some systems require additional charging of refrigerant.
- Only use tools exclusively for the refrigerant type used in the system, this to ensure pressure resistance and prevent foreign materials from entering into the system.
- Charge the liquid refrigerant as follows:

If	Then
A siphon tube is present (i.e., the cylinder is marked with "Liquid filling siphon attached")	Charge with the cylinder upright. 
A siphon tube is NOT present	Charge with the cylinder upside down. 

- Open refrigerant cylinders slowly.
- Charge the refrigerant in liquid form. Adding it in gas form may prevent normal operation.



CAUTION

When the refrigerant charging procedure is done or when pausing, close the valve of the refrigerant tank immediately. If the valve is NOT closed immediately, remaining pressure might charge additional refrigerant. **Possible consequence:** Incorrect refrigerant amount.

1.2.4 Water

If applicable. See the installation manual or installer reference guide of your application for more information.



NOTICE

Make sure water quality complies with EU directive 98/83 EC.

1.2.5 Electrical

**DANGER: RISK OF ELECTROCUTION**

- Turn OFF all power supply before removing the switch box cover, connecting electrical wiring or touching electrical parts.
- Disconnect the power supply for more than 10 minutes, and measure the voltage at the terminals of main circuit capacitors or electrical components before servicing. The voltage **MUST** be less than 50 V DC before you can touch electrical components. For the location of the terminals, see the wiring diagram.
- Do NOT touch electrical components with wet hands.
- Do NOT leave the unit unattended when the service cover is removed.

**WARNING**

If NOT factory installed, a main switch or other means for disconnection, having a contact separation in all poles providing full disconnection under overvoltage category III condition, **MUST** be installed in the fixed wiring.

**WARNING**

- **ONLY** use copper wires.
- Make sure the field wiring complies with the applicable legislation.
- All field wiring **MUST** be performed in accordance with the wiring diagram supplied with the product.
- **NEVER** squeeze bundled cables and make sure they do NOT come in contact with the piping and sharp edges. Make sure no external pressure is applied to the terminal connections.
- Make sure to install earth wiring. Do NOT earth the unit to a utility pipe, surge absorber, or telephone earth. Incomplete earth may cause electrical shock.
- Make sure to use a dedicated power circuit. **NEVER** use a power supply shared by another appliance.
- Make sure to install the required fuses or circuit breakers.
- Make sure to install an earth leakage protector. Failure to do so may cause electrical shock or fire.
- When installing the earth leakage protector, make sure it is compatible with the inverter (resistant to high frequency electric noise) to avoid unnecessary opening of the earth leakage protector.

**CAUTION**

- When connecting the power supply: connect the earth cable first, before making the current-carrying connections.
- When disconnecting the power supply: disconnect the current-carrying cables first, before separating the earth connection.
- The length of the conductors between the power supply stress relief and the terminal block itself must be as such that the current-carrying wires are tautened before the earth wire is in case the power supply is pulled loose from the stress relief.



NOTICE

Precautions when laying power wiring:

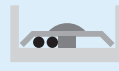

- Do NOT connect wiring of different thicknesses to the power terminal block (slack in the power wiring may cause abnormal heat).
- When connecting wiring which is the same thickness, do as shown in the figure above.
- For wiring, use the designated power wire and connect firmly, then secure to prevent outside pressure being exerted on the terminal board.
- Use an appropriate screwdriver for tightening the terminal screws. A screwdriver with a small head will damage the head and make proper tightening impossible.
- Over-tightening the terminal screws may break them.

Install power cables at least 1 m away from televisions or radios to prevent interference. Depending on the radio waves, a distance of 1 m may not be sufficient.



WARNING

- After finishing the electrical work, confirm that each electrical component and terminal inside the electrical components box is connected securely.
- Make sure all covers are closed before starting up the unit.



NOTICE

Only applicable if the power supply is three-phase, and the compressor has an ON/OFF starting method.

If there exists the possibility of reversed phase after a momentary black out and the power goes on and off while the product is operating, attach a reversed phase protection circuit locally. Running the product in reversed phase can break the compressor and other parts.

2 About the documentation

In this chapter

2.1	About this document.....	13
2.2	Installer reference guide at a glance.....	14

2.1 About this document

Target audience

Authorised installers

Documentation set

This document is part of a documentation set. The complete set consists of:

- **General safety precautions:**

- Safety instructions that you must read before installing
- Format: Paper (in the box of the indoor unit)

- **Operation manual:**

- Quick guide for basic usage
- Format: Paper (in the box of the indoor unit)

- **User reference guide:**

- Detailed step-by-step instructions and background information for basic and advanced usage
- Format: Digital files on <http://www.daikineurope.com/support-and-manuals/product-information/>

- **Installation manual – Outdoor unit:**

- Installation instructions
- Format: Paper (in the box of the outdoor unit)

- **Installation manual – Indoor unit:**

- Installation instructions
- Format: Paper (in the box of the indoor unit)

- **Installer reference guide:**

- Preparation of the installation, good practices, reference data, ...
- Format: Digital files on <http://www.daikineurope.com/support-and-manuals/product-information/>

- **Addendum book for optional equipment:**

- Additional info about how to install optional equipment
- Format: Paper (in the box of the indoor unit) + Digital files on <http://www.daikineurope.com/support-and-manuals/product-information/>

Latest revisions of the supplied documentation may be available on the regional Daikin website or via your dealer.

The original documentation is written in English. All other languages are translations.

Technical engineering data

- A **subset** of the latest technical data is available on the regional Daikin website (publicly accessible).
- The **full set** of latest technical data is available on the Daikin Business Portal (authentication required).

Online tools

In addition to the documentation set, some online tools are available for installers:

- **Daikin Technical Data Hub**
 - Central hub for technical specifications of the unit, useful tools, digital resources, and more.
 - Publicly accessible via <https://daikintechnicaldatahub.eu>.
- **Heating Solutions Navigator**
 - Digital toolbox that offers a variety of tools to facilitate the installation and configuration of heating systems.
 - To access Heating Solutions Navigator, registration to the Stand By Me platform is required. For more information, see <https://professional.standbyme.daikin.eu>.
- **Daikin e-Care**
 - Mobile app for installers and service technicians that allows you to register, configure and troubleshoot heating systems.
 - The mobile app can be downloaded for iOS and Android devices using the QR codes below. Registration to the Stand By Me platform is required to access the app.

App Store



Google Play



2.2 Installer reference guide at a glance

Chapter	Description
General safety precautions	Safety instructions that you must read before installing
About the documentation	What documentation exists for the installer
About the box	How to unpack the units and remove their accessories
About the units and options	<ul style="list-style-type: none"> ▪ How to identify the units ▪ Possible combinations of units and options
Application guidelines	Various installation setups of the system
Unit installation	What to do and know to install the system, including information on how to prepare for an installation

Chapter	Description
Piping installation	What to do and know to install the piping of the system, including information on how to prepare for an installation
Electrical installation	What to do and know to install the electrical components of the system, including information on how to prepare for an installation
Configuration	What to do and know to configure the system after it is installed
Commissioning	What to do and know to commission the system after it is configured
Hand-over to the user	What to give and explain to the user
Maintenance and service	How to maintain and service the units
Troubleshooting	What to do in case of problems
Disposal	How to dispose of the system
Technical data	Specifications of the system
Glossary	Definition of terms
Field settings table	Table to be filled in by the installer, and kept for future reference Note: There is also an installer settings table in the user reference guide. This table has to be filled in by the installer and handed over to the user.

3 About the box

In this chapter

3.1	Overview: About the box.....	16
3.2	Outdoor unit.....	16
3.2.1	To handle the outdoor unit.....	16
3.2.2	To unpack the outdoor unit.....	18
3.2.3	To remove the accessories from the outdoor unit.....	19
3.3	Indoor unit.....	20
3.3.1	To unpack the indoor unit.....	20
3.3.2	To remove the accessories from the indoor unit.....	20
3.3.3	To handle the indoor unit.....	20

3.1 Overview: About the box

This chapter describes what you have to do after the boxes with the outdoor and indoor unit are delivered on-site.

Keep the following in mind:

- At delivery, the unit **MUST** be checked for damage. Any damage **MUST** be reported immediately to the claims agent of the carrier.
- Bring the packed unit as close as possible to its final installation position to prevent damage during transport.
- Prepare the path along which you want to bring the unit inside in advance.

3.2 Outdoor unit

3.2.1 To handle the outdoor unit



CAUTION
To avoid injury, do NOT touch the air inlet or aluminium fins of the unit.

Crane

Keep the slings within the marked area to not damage the unit.

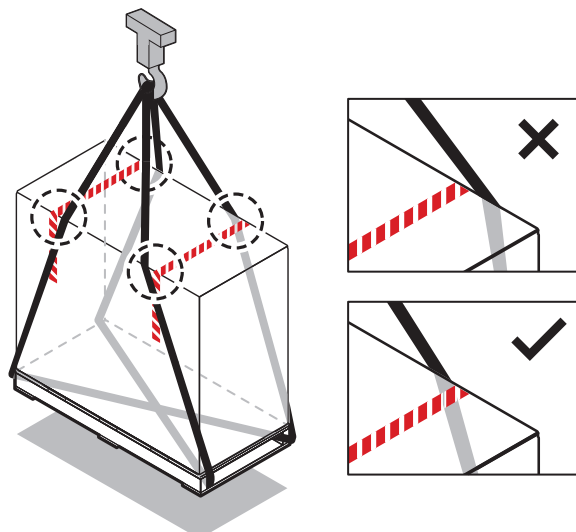

Forklift or pallet truck

Enter the pallet from the heavy side.

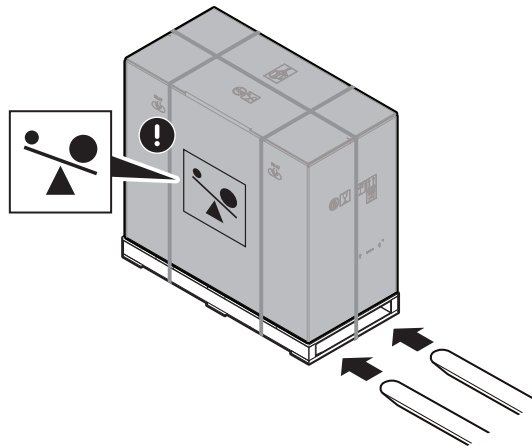

Manually

After unpacking, carry the unit using the slings attached to the unit.

See also:

- "To unpack the outdoor unit" [▶ 18]
- "To install the outdoor unit" [▶ 64]

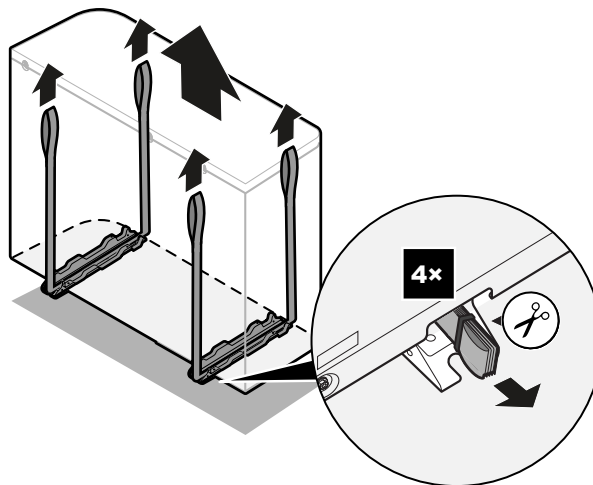
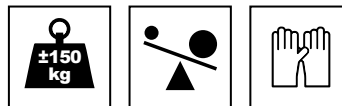

3.2.2 To unpack the outdoor unit

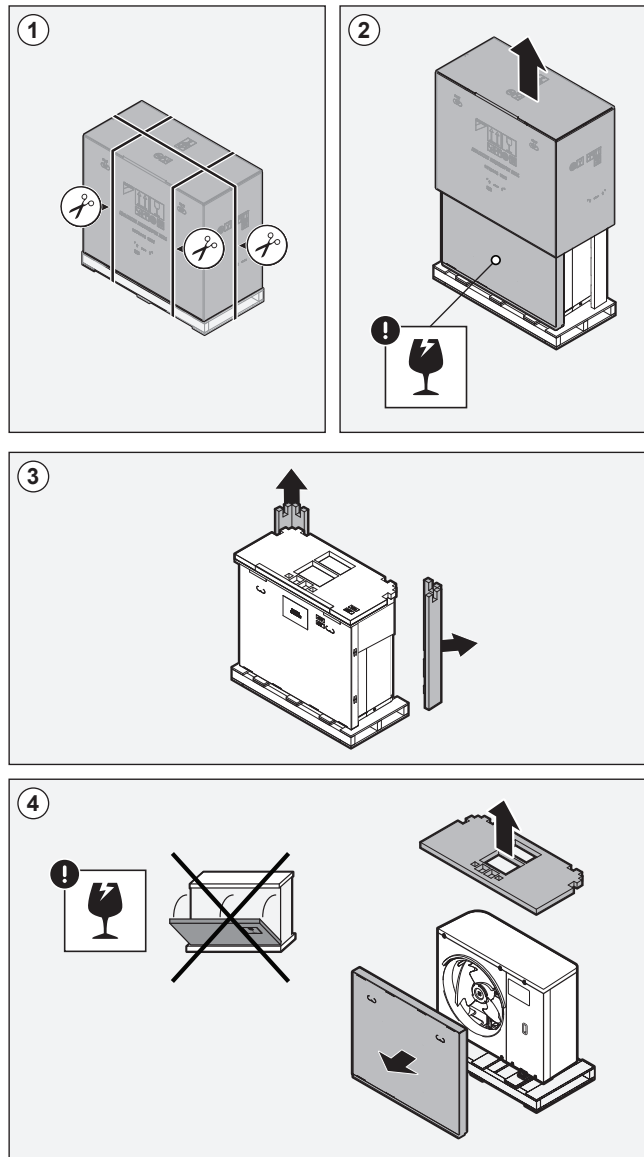

a, b Accessories

3.2.3 To remove the accessories from the outdoor unit

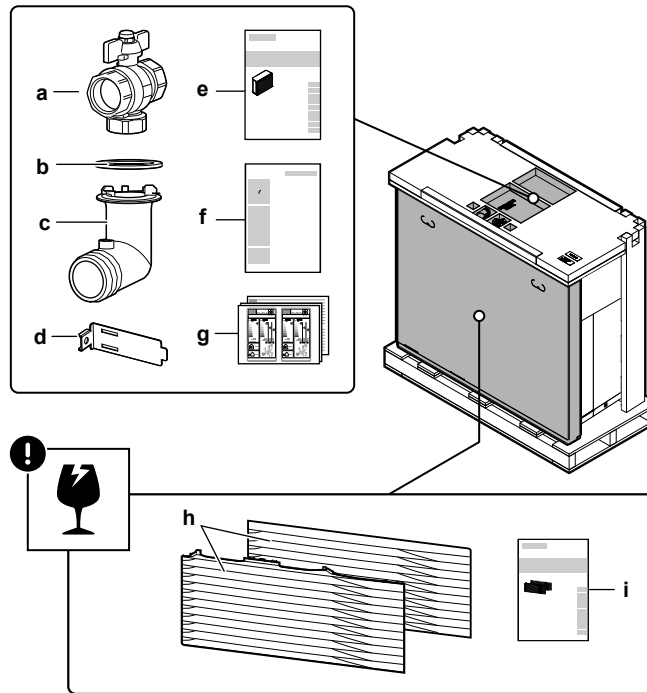

- a Shut-off valve (with integrated filter)
- b O-ring for drain socket
- c Drain socket
- d Thermistor fixture (for installations in areas with low ambient temperatures)
- e Installation manual – Outdoor unit
- f Disposal manual – Recovering refrigerant
- g Energy label
- h Discharge grille (upper + lower part)
- i Installation manual – Discharge grille

**NOTICE**

Unpacking. When you remove the top packaging/accessories, hold the box containing the discharge grille to prevent it from falling.

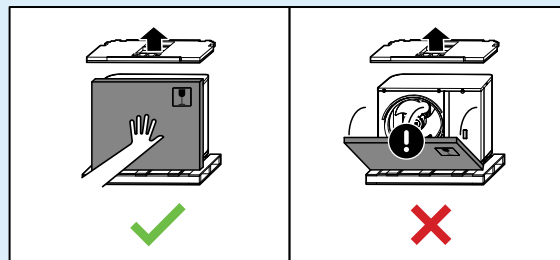

3.3 Indoor unit

3.3.1 To unpack the indoor unit

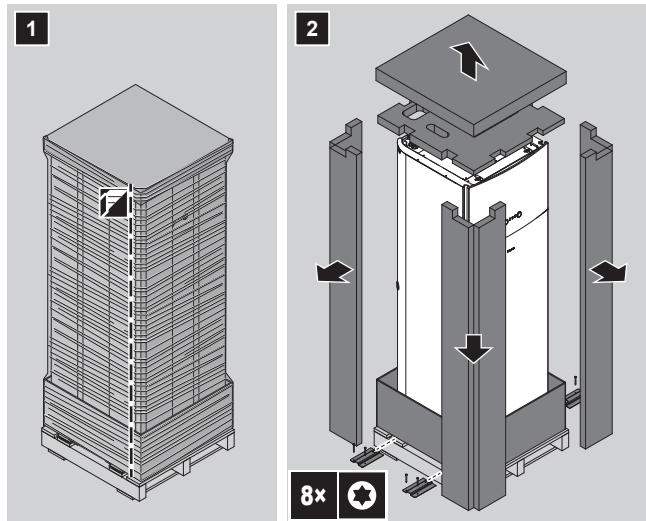

3.3.2 To remove the accessories from the indoor unit

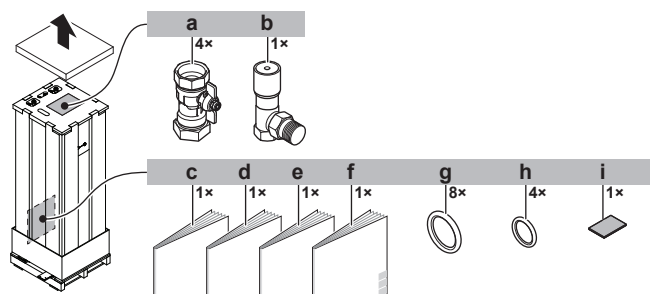

- a Shut-off valves for water circuit
- b Overpressure bypass valve
- c General safety precautions
- d Addendum book for optional equipment
- e Indoor unit installation manual
- f Operation manual
- g Sealing rings for shut-off valves (space heating water circuit)
- h Sealing rings for field-supplied shut-off valves (domestic hot water circuit)
- i Sealing tape for low voltage wiring intake

3.3.3 To handle the indoor unit

Use the handles at the back and at the bottom to carry the unit.

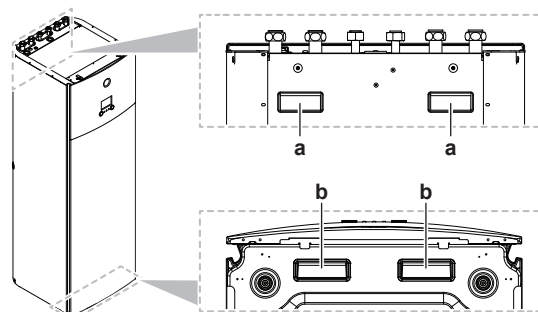

- a Handles at the back of the unit
- b Handles at the bottom of the unit. Carefully tilt the unit to the back so that the handles become visible.

4 About the units and options

In this chapter

4.1	Overview: About the units and options	21
4.2	Identification.....	21
4.2.1	Identification label: Outdoor unit.....	21
4.2.2	Identification label: Indoor unit.....	22
4.3	Combining units and options.....	22
4.3.1	Possible combinations of indoor unit and outdoor unit	22
4.3.2	Possible options for the outdoor unit.....	23
4.3.3	Possible options for the indoor unit	23

4.1 Overview: About the units and options

This chapter contains information about:

- Identifying the outdoor unit
- Identifying the indoor unit
- Combining the outdoor unit with options
- Combining the indoor unit with options

4.2 Identification



NOTICE

When installing or servicing several units at the same time, make sure NOT to switch the service panels between different models.

4.2.1 Identification label: Outdoor unit

Location

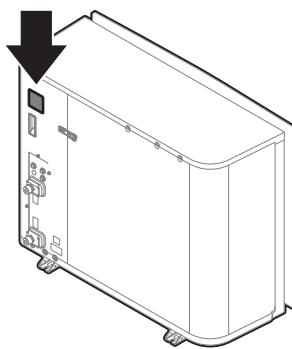

Model identification

Example: EP R A 14 DA V3

Code	Explanation
EP	European hydro-split outdoor pair heat pump
R	High water temperature – ambient zone 2 (see operation range)
A	Refrigerant R32

Code	Explanation
14	Capacity class
DA	Model series
V3	Power supply

4.2.2 Identification label: Indoor unit

Location

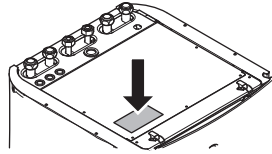

Model identification

Example: E TV H 16 S 23 DA 6V G

Code	Description
E	European model
TV	Floor-standing hydro-split unit with integrated tank
H	H=Heating only X=Heating/cooling
16	Capacity class
S	Integrated tank material: Stainless steel
23	Integrated tank volume
DA	Model series
6V	Backup heater model
G	G=Grey model [—]=White model

4.3 Combining units and options



INFORMATION

Certain options might not be available in your country.

4.3.1 Possible combinations of indoor unit and outdoor unit

Indoor unit	Outdoor unit		
	EPRA14	EPRA16	EPRA18
ETVH/X16	○	○	○

4.3.2 Possible options for the outdoor unit

Mounting stand (EKMST1, EKMST2)

In colder regions where heavy snowfall can occur, it is recommended to install the outdoor unit on a mounting frame. Use one of the following models:

- EKMST1 with flange feet: to install the outdoor unit on a concrete foundation where drilling is allowed.
- EKMST2 with rubber feet: to install the outdoor unit on foundations where drilling is not allowed or possible, such as flat roofs or pavements.

For installation instructions, see the installation manual of the mounting stand.

4.3.3 Possible options for the indoor unit

Multi-zoning wired controls

You can connect the following multi-zoning wired controls:

- Multi-zoning base unit 230 V (EKWUFHTA1V3)
- Digital thermostat 230 V (EKWCTRDI1V3)
- Analogue thermostat 230 V (EKWCTRAN1V3)
- Actuator 230 V (EKWCVATR1V3)

For installation instructions, see the installation manual of the control, and the addendum book for optional equipment.

Wireless room thermostat (EKRTR1)

You can connect an optional wireless room thermostat to the indoor unit.

For installation instructions, see the installation manual of the room thermostat and addendum book for optional equipment.

Remote sensor for wireless thermostat (EKRTETS)

You can use the remote indoor temperature sensor (EKRTETS) only in combination with the wireless thermostat (EKRTR1).

For installation instructions, see the installation manual of the room thermostat and the addendum book for optional equipment.

Digital I/O PCB (EKR1HBAA)

The digital I/O PCB is required to provide following signals:

- Alarm output
- Space heating/cooling On/OFF output
- Changeover to external heat source

For installation instructions, see the installation manual of the digital I/O PCB and addendum book for optional equipment.

Demand PCB (EKR1AHTA)

To enable the power saving consumption control by digital inputs you must install the demand PCB.

For installation instructions, see the installation manual of the demand PCB and addendum book for optional equipment.

Remote indoor sensor (KRCS01-1)

By default the internal sensor of the dedicated Human Comfort Interface (BRC1HHDA used as room thermostat) will be used as room temperature sensor.

As an option the remote indoor sensor can be installed to measure the room temperature on another location.

For installation instructions, see the installation manual of the remote indoor sensor and addendum book for optional equipment.



INFORMATION

- The remote indoor sensor can only be used in case the user interface is configured with room thermostat functionality.
- You can only connect either the remote indoor sensor or the remote outdoor sensor.

Remote outdoor sensor (EKRS01)

By default the sensor inside the outdoor unit will be used to measure the outdoor temperature.

As an option the remote outdoor sensor can be installed to measure the outdoor temperature on another location (e.g. to avoid direct sunlight) to have an improved system behaviour.

For installation instructions, see the installation manual of the remote outdoor sensor and the addendum book for optional equipment.



INFORMATION

You can only connect either the remote indoor sensor or the remote outdoor sensor.

PC cable (EKPCAB4)

The PC cable makes a connection between the switch box of the indoor unit and a PC. It gives the possibility to update the software of the indoor unit.

For installation instructions, see the installation manual of the PC cable.

Heat pump convector (FWXV, FWXT, FWXM)

For providing space heating/cooling, it is possible to use the following heat pump convectors:

- FWXV: floor-standing model
- FWXT: wall-mounted model
- FWXM: concealed model

For installation instructions, see:

- The installation manual of the heat pump convectors
- The installation manual of the heat pump convector options
- The addendum book for optional equipment

LAN adapter for smartphone control + Smart Grid applications (BRP069A61)

You can install this LAN adapter to:

- Control the system via a smartphone app.
- Use the system in various Smart Grid applications.

For installation instructions, see the installation manual of the LAN adapter and the addendum book for optional equipment.

LAN adapter for smartphone control (BRP069A62)

You can install this LAN adapter to control the system via a smartphone app.

For installation instructions, see the installation manual of the LAN adapter and the addendum book for optional equipment.

WLAN adapter (BRP069A71)

You can install the wireless LAN adapter to control the system via a smartphone app.

For installation instructions, see the installation manual of the WLAN adapter and the addendum book for optional equipment.

Universal centralised controller (EKCC8-W)

Controller for cascade control.

Bizone kit (BZKA7V3)

You can install an optional bizone kit.

For installation instructions, see the installation manual of the bizone kit.

Conversion kit (EKHVCONV2)

Use the connection kit to convert a heating only model to a reversible model.

For installation instructions, see the installation manual of the conversion kit.

Human Comfort Interface (BRC1HHDA) used as room thermostat

- The Human Comfort Interface (HCI) used as room thermostat can only be used in combination with the user interface connected to the indoor unit.
- The Human Comfort Interface (HCI) used as room thermostat needs to be installed in the room that you want to control.

For installation instructions, see the installation and operation manual of the Human Comfort Interface (HCI) as room thermostat.

5 Application guidelines



INFORMATION

Cooling is only applicable in case of:

- Reversible models
- Heating only models + conversion kit (EKHVCONV2)

In this chapter

5.1	Overview: Application guidelines	26
5.2	Setting up the space heating/cooling system	27
5.2.1	Single room.....	28
5.2.2	Multiple rooms – One LWT zone	32
5.2.3	Multiple rooms – Two LWT zones	36
5.3	Setting up an auxiliary heat source for space heating.....	39
5.4	Setting up the domestic hot water tank	42
5.4.1	System layout – Integrated DHW tank	42
5.4.2	Selecting the volume and desired temperature for the DHW tank.....	42
5.4.3	Setup and configuration – DHW tank.....	44
5.4.4	DHW pump for instant hot water	44
5.4.5	DHW pump for disinfection	45
5.5	Setting up the energy metering	45
5.5.1	Produced heat.....	46
5.5.2	Consumed energy	46
5.5.3	Normal kWh rate power supply.....	47
5.5.4	Preferential kWh rate power supply.....	48
5.6	Setting up the power consumption control.....	49
5.6.1	Permanent power limitation.....	49
5.6.2	Power limitation activated by digital inputs	50
5.6.3	Power limitation process	51
5.6.4	BBR16 power limitation	52
5.7	Setting up an external temperature sensor.....	52

5.1 Overview: Application guidelines

The purpose of the application guidelines is to give a glance of the possibilities of the heat pump system.



NOTICE

- The illustrations in the application guidelines are meant for reference only, and are NOT to be used as detailed hydraulic diagrams. The detailed hydraulic dimensioning and balancing are NOT shown, and are the responsibility of the installer.
- For more information about the configuration settings to optimize heat pump operation, see "[9 Configuration](#)" [▶ 115].

This chapter contains application guidelines for:

- Setting up the space heating/cooling system
- Setting up an auxiliary heat source for space heating
- Setting up the domestic hot water tank
- Setting up the energy metering
- Setting up the power consumption control
- Setting up an external temperature sensor

**NOTICE**

Certain types of fan coil units –in this document referred to as "heat pump convectors"–, are able to receive input of the indoor unit operation mode (cooling or heating X2M/3 and X2M/4) and/or to send output of the heat pump convector thermostatic condition (main zone: X2M/30 and X2M/35; additional zone: X2M/30 and X2M/35a).

The application guidelines illustrate the possibility of receiving or sending digital input/output. This functionality can only be used in case the heat pump convector has such features and the signals meet following requirements:

- Output of indoor unit (input to heat pump convector): cooling/heating signal=230 V (cooling=230 V, heating=0 V).
- Input to indoor unit (output of heat pump convector): thermostat ON/OFF signal=voltage-free contact (closed contact=thermo ON, open contact=thermo OFF).

5.2 Setting up the space heating/cooling system

The heat pump system supplies leaving water to heat emitters in one or more rooms.

Because the system offers a wide flexibility to control the temperature in each room, you need to answer the following questions first:

- How many rooms are heated or cooled by the heat pump system?
- Which heat emitter types are used in each room and what is their design leaving water temperature?

Once the space heating/cooling requirements are clear, we recommend to follow the setup guidelines below.

**NOTICE**

If an external room thermostat is used, the external room thermostat will control the room frost protection. However, the room frost protection is only possible if [C.2] **Space heating/cooling=On**.

**INFORMATION**

In case an external room thermostat is used and room frost protection needs to be guaranteed in all conditions, then you have to set **Emergency** [9.5.1] to **Automatic**.

**NOTICE**

An overpressure bypass valve can be integrated in the system. Keep in mind that this valve might not be shown on the illustrations.

5.2.1 Single room

Underfloor heating or radiators – Wired room thermostat

Setup

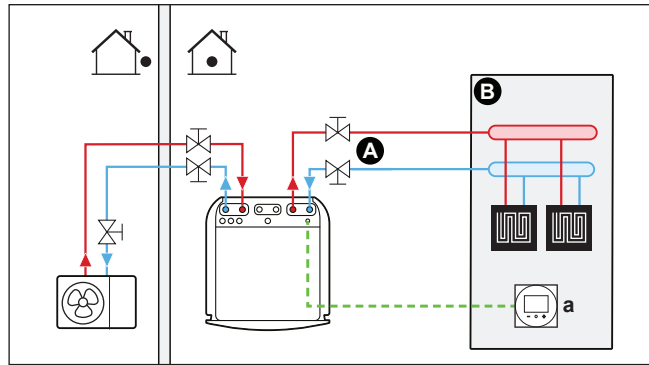

- A Main leaving water temperature zone
- B One single room
- a Dedicated Human Comfort Interface (BRC1HHDA used as room thermostat)

- For more information about connecting the electrical wiring to the unit, see:
 - "8.2 Connections to the outdoor unit" [▶ 91]
 - "8.3 Connections to the indoor unit" [▶ 98]
- The underfloor heating or radiators are directly connected to the indoor unit.
- The room temperature is controlled by the dedicated Human Comfort Interface (BRC1HHDA used as room thermostat).

Configuration

Setting	Value
Unit temperature control: ▪ #: [2.9] ▪ Code: [C-07]	2 (Room thermostat): Unit operation is decided based on the ambient temperature of the dedicated Human Comfort Interface.
Number of water temperature zones: ▪ #: [4.4] ▪ Code: [7-02]	0 (Single zone): Main

Benefits

- **Highest comfort and efficiency.** The smart room thermostat functionality can decrease or increase the desired leaving water temperature based on the actual room temperature (modulation). This results in:
 - Stable room temperature matching the desired temperature (higher comfort)
 - Less ON/OFF cycles (more quiet, higher comfort and higher efficiency)
 - Lowest possible leaving water temperature (higher efficiency)
- **Easy.** You can easily set the desired room temperature via the user interface:
 - For your daily needs, you can use preset values and schedules.
 - To deviate from your daily needs, you can temporarily overrule the preset values and schedules, or use the holiday mode.

Underfloor heating or radiators – Wireless room thermostat

Setup

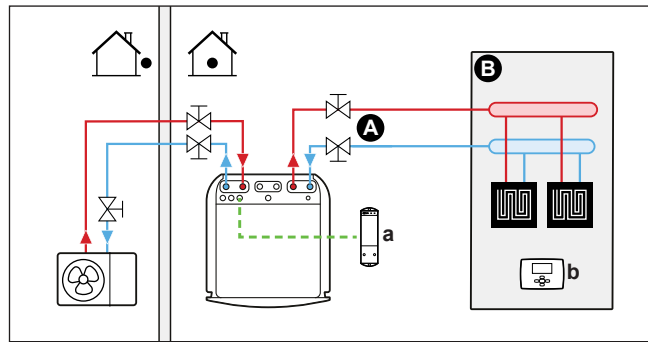

- A** Main leaving water temperature zone
- B** One single room
- a** Receiver for wireless external room thermostat
- b** Wireless external room thermostat

- For more information about connecting the electrical wiring to the unit, see:
 - "8.2 Connections to the outdoor unit" [▶ 91]
 - "8.3 Connections to the indoor unit" [▶ 98]
- The underfloor heating or radiators are directly connected to the indoor unit.
- The room temperature is controlled by the wireless external room thermostat (optional equipment EKTR1).

Configuration

Setting	Value
Unit temperature control: ▪ #: [2.9] ▪ Code: [C-07]	1 (External room thermostat): Unit operation is decided by the external thermostat.
Number of water temperature zones: ▪ #: [4.4] ▪ Code: [7-02]	0 (Single zone): Main
External room thermostat for the main zone: ▪ #: [2.A] ▪ Code: [C-05]	1 (1 contact): When the used external room thermostat or heat pump convector can only send a thermo ON/OFF condition. No separation between heating or cooling demand.

Benefits

- **Wireless.** The Daikin external room thermostat is available in a wireless version.
- **Efficiency.** Although the external room thermostat only sends ON/OFF signals, it is specifically designed for the heat pump system.
- **Comfort.** In case of underfloor heating, the wireless external room thermostat prevents condensation on the floor during cooling operation by measuring the room humidity.

Heat pump convectors

Setup

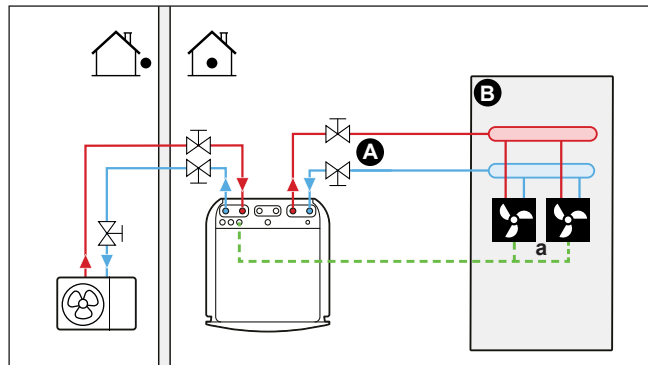

- A** Main leaving water temperature zone
- B** One single room
- a** Heat pump convectors (+ controllers)

- For more information about connecting the electrical wiring to the unit, see:
 - "8.2 Connections to the outdoor unit" [▶ 91]
 - "8.3 Connections to the indoor unit" [▶ 98]
- The heat pump convectors are directly connected to the indoor unit.
- The desired room temperature is set via the controller of the heat pump convectors. There are different controllers and setups possible for the heat pump convectors. For more information, see:
 - The installation manual of the heat pump convectors
 - The installation manual of the heat pump convector options
 - The addendum book for optional equipment
- The space heating/cooling demand signal is sent to one digital input on the indoor unit (X2M/35 and X2M/30).
- The space operation mode is sent to the heat pump convectors by one digital output on the indoor unit (X2M/4 and X2M/3).

Configuration

Setting	Value
Unit temperature control: ▪ #: [2.9] ▪ Code: [C-07]	1 (External room thermostat): Unit operation is decided by the external thermostat.
Number of water temperature zones: ▪ #: [4.4] ▪ Code: [7-02]	0 (Single zone): Main
External room thermostat for the main zone: ▪ #: [2.A] ▪ Code: [C-05]	1 (1 contact): When the used external room thermostat or heat pump convector can only send a thermo ON/OFF condition. No separation between heating or cooling demand.

Benefits

- **Cooling.** The heat pump convector offers, besides heating capacity, also excellent cooling capacity.
- **Efficiency.** Optimal energy efficiency because of the interlink function.

- **Stylish.**

Combination: Underfloor heating + Heat pump convectors

- Space heating is provided by:
 - The underfloor heating
 - The heat pump convectors
- Space cooling is provided by the heat pump convectors only. The underfloor heating is shut off by the shut-off valve.

Setup

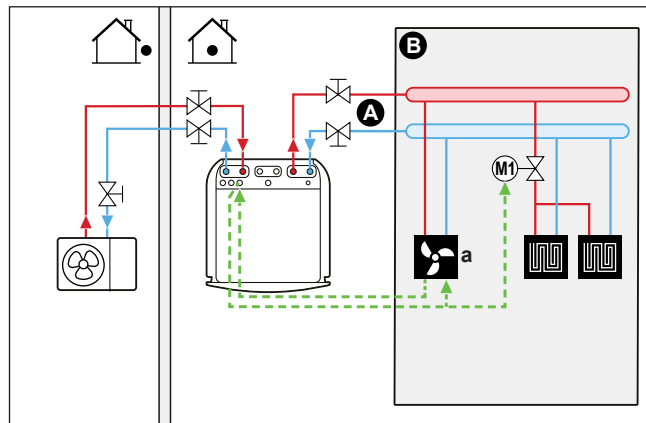

- A** Main leaving water temperature zone
- B** One single room
- a** Heat pump convectors (+ controllers)

- For more information about connecting the electrical wiring to the unit, see:
 - ["8.2 Connections to the outdoor unit"](#) [▶ 91]
 - ["8.3 Connections to the indoor unit"](#) [▶ 98]
- The heat pump convectors are directly connected to the indoor unit.
- A shut-off valve (field supply) is installed before the underfloor heating to prevent condensation on the floor during cooling operation.
- The desired room temperature is set via the controller of the heat pump convectors. There are different controllers and setups possible for the heat pump convectors. For more information, see:
 - The installation manual of the heat pump convectors
 - The installation manual of the heat pump convector options
 - The addendum book for optional equipment
- The space heating/cooling demand signal is sent to one digital input on the indoor unit (X2M/35 and X2M/30).
- The space operation mode is sent by one digital output (X2M/4 and X2M/3) on the indoor unit to:
 - The heat pump convectors
 - The shut-off valve

Configuration

Setting	Value
Unit temperature control:	1 (External room thermostat):
▪ #: [2.9]	Unit operation is decided by the external thermostat.
▪ Code: [C-07]	

Setting	Value
Number of water temperature zones: ▪ #: [4.4] ▪ Code: [7-02]	0 (Single zone): Main
External room thermostat for the main zone: ▪ #: [2.A] ▪ Code: [C-05]	1 (1 contact): When the used external room thermostat or heat pump convector can only send a thermo ON/OFF condition. No separation between heating or cooling demand.

Benefits

- **Cooling.** Heat pump convectors provide, besides heating capacity, also excellent cooling capacity.
- **Efficiency.** Underfloor heating has the best performance with the heat pump system.
- **Comfort.** The combination of the two heat emitter types provides:
 - The excellent heating comfort of the underfloor heating
 - The excellent cooling comfort of the heat pump convectors

5.2.2 Multiple rooms – One LWT zone

If only one leaving water temperature zone is needed because the design leaving water temperature of all heat emitters is the same, you do NOT need a mixing valve station (cost effective).

Example: If the heat pump system is used to heat up one floor where all the rooms have the same heat emitters.

Underfloor heating or radiators – Thermostatic valves

If you are heating up rooms with underfloor heating or radiators, a very common way is to control the temperature of the main room by using a thermostat (this can either be the dedicated Human Comfort Interface (BRC1HHDA) or an external room thermostat), while the other rooms are controlled by so-called thermostatic valves, which open or close depending on the room temperature.

Setup

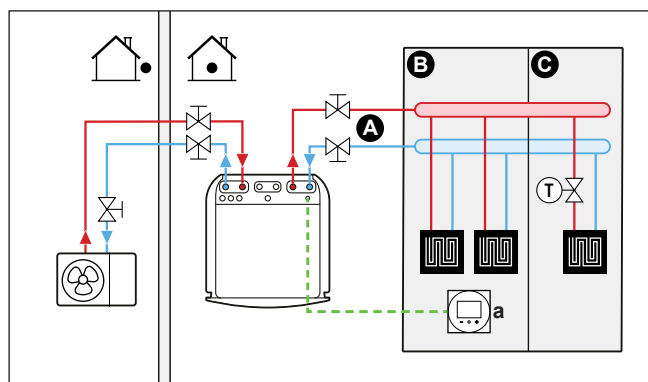

- A** Main leaving water temperature zone
- B** Room 1
- C** Room 2
- a** Dedicated Human Comfort Interface (BRC1HHDA used as room thermostat)

- For more information about connecting the electrical wiring to the unit, see:
 - "8.2 Connections to the outdoor unit" [▶ 91]
 - "8.3 Connections to the indoor unit" [▶ 98]
- The underfloor heating of the main room is directly connected to the indoor unit.
- The room temperature of the main room is controlled by the dedicated Human Comfort Interface (BRC1HHDA used as room thermostat).
- A thermostatic valve is installed before the underfloor heating in each of the other rooms.



INFORMATION

Mind situations where the main room can be heated by another heating source.
Example: Fireplaces.

Configuration

Setting	Value
Unit temperature control: <ul style="list-style-type: none"> #: [2.9] Code: [C-07] 	2 (Room thermostat): Unit operation is decided based on the ambient temperature of the dedicated Human Comfort Interface.
Number of water temperature zones: <ul style="list-style-type: none"> #: [4.4] Code: [7-02] 	0 (Single zone): Main

Benefits

- Easy.** Same installation as for one room, but with thermostatic valves.

Underfloor heating or radiators – Multiple external room thermostats

Setup

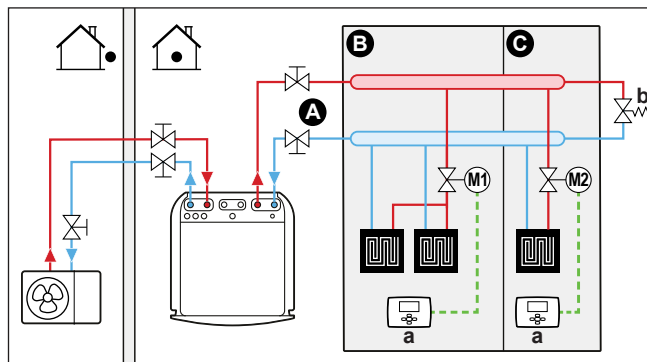

- A** Main leaving water temperature zone
- B** Room 1
- C** Room 2
- a** External room thermostat
- b** Bypass valve

- For more information about connecting the electrical wiring to the unit, see:
 - "8.2 Connections to the outdoor unit" [▶ 91]
 - "8.3 Connections to the indoor unit" [▶ 98]
- For each room, a shut-off valve (field supplied) is installed to avoid leaving water supply when there is no heating or cooling demand.

- A bypass valve must be installed to make water recirculation possible when all shut-off valves are closed. To guarantee reliable operation, provide a minimum water flow as described in table "To check the water volume and flow rate" in "7.1 Preparing water piping" [▶ 73].
- The user interface integrated in the indoor unit decides the space operation mode. Mind that the operation mode on each room thermostat must be set to match the indoor unit.
- The room thermostats are connected to the shut-off valves, but do NOT have to be connected to the indoor unit. The indoor unit will supply leaving water all the time, with the possibility to program a leaving water schedule.

Configuration

Setting	Value
Unit temperature control: ▪ #: [2.9] ▪ Code: [C-07]	0 (Leaving water): Unit operation is decided based on the leaving water temperature.
Number of water temperature zones: ▪ #: [4.4] ▪ Code: [7-02]	0 (Single zone): Main

Benefits

Compared with underfloor heating or radiators for one room:

- **Comfort.** You can set the desired room temperature, including schedules, for each room via the room thermostats.

Heat pump convectors – Multiple rooms

Setup

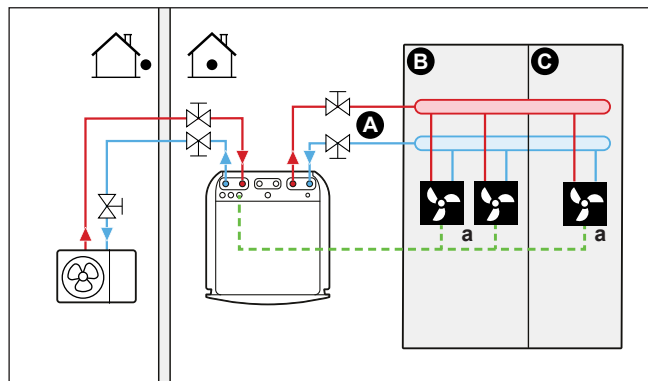

- A** Main leaving water temperature zone
- B** Room 1
- C** Room 2
- a** Heat pump convectors (+ controllers)

- For more information about connecting the electrical wiring to the unit, see:
 - "8.2 Connections to the outdoor unit" [▶ 91]
 - "8.3 Connections to the indoor unit" [▶ 98]

- The desired room temperature is set via the controller of the heat pump convectors. There are different controllers and setups possible for the heat pump convectors. For more information, see:
 - The installation manual of the heat pump convectors
 - The installation manual of the heat pump convector options
 - The addendum book for optional equipment
- The user interface integrated in the indoor unit decides the space operation mode.
- The heating or cooling demand signals of each heat pump convector are connected in parallel to the digital input on the indoor unit (X2M/35 and X2M/30). The indoor unit will only supply leaving water temperature when there is an actual demand.



INFORMATION

To increase comfort and performance, we recommend to install the valve kit option EKVKHPC on each heat pump convector.

Configuration

Setting	Value
Unit temperature control: <ul style="list-style-type: none"> ▪ #: [2.9] ▪ Code: [C-07] 	1 (External room thermostat): Unit operation is decided by the external thermostat.
Number of water temperature zones: <ul style="list-style-type: none"> ▪ #: [4.4] ▪ Code: [7-02] 	0 (Single zone): Main

Benefits

Compared with heat pump convectors for one room:

- **Comfort.** You can set the desired room temperature, including schedules, for each room via the remote controller of the heat pump convectors.

Combination: Underfloor heating + Heat pump convectors – Multiple rooms

Setup

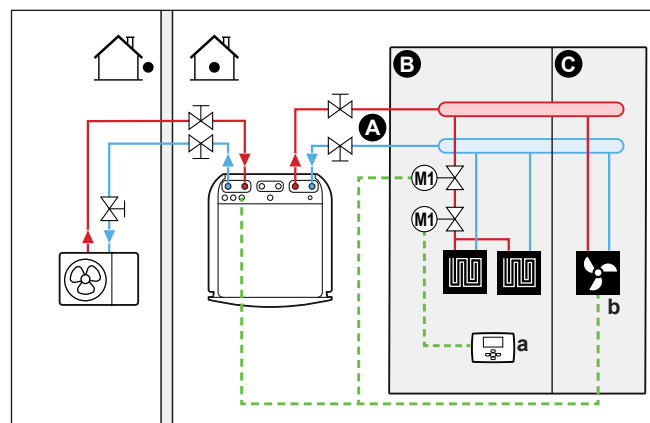

- A** Main leaving water temperature zone
- B** Room 1
- C** Room 2
- a** External room thermostat
- b** Heat pump convectors (+ controllers)

- For more information about connecting the electrical wiring to the unit, see:
 - "8.2 Connections to the outdoor unit" [▶ 91]
 - "8.3 Connections to the indoor unit" [▶ 98]
- For each room with heat pump convectors: The heat pump convectors are directly connected to the indoor unit.
- For each room with underfloor heating: Two shut-off valves (field supply) are installed before the underfloor heating:
 - A shut-off valve to prevent hot water supply when the room has no heating demand
 - A shut-off valve to prevent condensation on the floor during cooling operation of the rooms with heat pump convectors.
- For each room with heat pump convectors: The desired room temperature is set via the controller of the heat pump convectors. There are different controllers and setups possible for the heat pump convectors. For more information, see:
 - The installation manual of the heat pump convectors
 - The installation manual of the heat pump convector options
 - The addendum book for optional equipment
- For each room with underfloor heating: The desired room temperature is set via the external room thermostat (wired or wireless).
- The user interface integrated in the indoor unit decides the space operation mode. Mind that the operation mode on each external room thermostat and controller of the heat pump convectors must be set to match the indoor unit.



INFORMATION

To increase comfort and performance, we recommend to install the valve kit option EKVKHP on each heat pump convector.

Configuration

Setting	Value
Unit temperature control: <ul style="list-style-type: none"> ▪ #: [2.9] ▪ Code: [C-07] 	0 (Leaving water): Unit operation is decided based on the leaving water temperature.
Number of water temperature zones: <ul style="list-style-type: none"> ▪ #: [4.4] ▪ Code: [7-02] 	0 (Single zone): Main

5.2.3 Multiple rooms – Two LWT zones

In this document:

- Main zone = Zone with the lowest design temperature in heating, and the highest design temperature in cooling
- Additional zone = Zone with the highest design temperature in heating, and the lowest design temperature in cooling

**CAUTION**

If there is more than one leaving water zone, ALWAYS install a mixing valve station in the main zone to decrease (in heating)/increase (in cooling) the leaving water temperature when the additional zone has demand.

Typical example:

Room (zone)	Heat emitters: Design temperature
Living room (main zone)	Underfloor heating: <ul style="list-style-type: none"> ▪ In heating: 35°C ▪ In cooling: 20°C (only refreshment, no real cooling allowed)
Bed rooms (additional zone)	Heat pump convectors: <ul style="list-style-type: none"> ▪ In heating: 45°C ▪ In cooling: 12°C

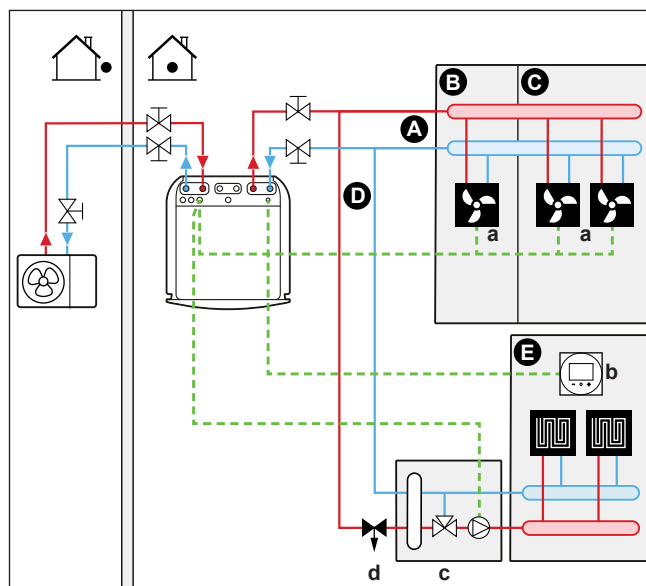
Setup

- A Additional leaving water temperature zone
- B Room 1
- C Room 2
- D Main leaving water temperature zone
- E Room 3
- a Heat pump convectors (+ controllers)
- b Dedicated Human Comfort Interface (BRC1HHDA used as room thermostat)
- c Mixing valve station
- d Pressure regulating valve

**INFORMATION**

A pressure regulating valve should be implemented before the mixing valve station. This is to guarantee the correct water flow balance between the main leaving water temperature zone and the additional leaving water temperature zone in relation to the required capacity of both water temperature zones.

- For more information about connecting the electrical wiring to the unit, see:
 - "8.2 Connections to the outdoor unit" [▶ 91]
 - "8.3 Connections to the indoor unit" [▶ 98]

- For the main zone:
 - A mixing valve station is installed before the underfloor heating.
 - The pump of the mixing valve station is controlled by the ON/OFF signal on the indoor unit (X2M/29 and X2M/21; normally closed shut-off valve output).
 - The room temperature is controlled by the dedicated Human Comfort Interface (BRC1HHDA used as room thermostat).
- For the additional zone:
 - The heat pump convectors are directly connected to the indoor unit.
 - The desired room temperature is set via the controller of the heat pump convectors. There are different controllers and setups possible for the heat pump convectors. For more information, see:
 - The installation manual of the heat pump convectors
 - The installation manual of the heat pump convector options
 - The addendum book for optional equipment
 - The heating or cooling demand signals of each heat pump convector are connected in parallel to the digital input on the indoor unit (X2M/35a and X2M/30). The indoor unit will only supply the desired additional leaving water temperature when there is an actual demand.
- The user interface integrated in the indoor unit decides the space operation mode. Mind that the operation mode on each controller of the heat pump convectors must be set to match the indoor unit.

Configuration

Setting	Value
Unit temperature control: <ul style="list-style-type: none"> ▪ #: [2.9] ▪ Code: [C-07] 	2 (Room thermostat): Unit operation is decided based on the ambient temperature of the dedicated Human Comfort Interface. Note: <ul style="list-style-type: none"> ▪ Main room = dedicated Human Comfort Interface used as room thermostat functionality ▪ Other rooms = external room thermostat functionality
Number of water temperature zones: <ul style="list-style-type: none"> ▪ #: [4.4] ▪ Code: [7-02] 	1 (Dual zone): Main + additional
In case of heat pump convectors: External room thermostat for the additional zone: <ul style="list-style-type: none"> ▪ #: [3.A] ▪ Code: [C-06] 	1 (1 contact): When the used external room thermostat or heat pump convector can only send a thermo ON/OFF condition. No separation between heating or cooling demand.
Shut-off valve output	Set to follow the thermo demand of the main zone.
Shut-off valve	If the main zone must be shut off during cooling mode to prevent condensation on the floor, set it accordingly.

Setting	Value
At the mixing valve station	Set the desired main leaving water temperature for heating and/or cooling.

Benefits

▪ Comfort.

- The smart room thermostat functionality can decrease or increase the desired leaving water temperature based on the actual room temperature (modulation).
- The combination of the two heat emitter systems provides the excellent heating comfort of the underfloor heating, and the excellent cooling comfort of the heat pump convectors.

▪ Efficiency.

- Depending on the demand, the indoor unit supplies different leaving water temperature matching the design temperature of the different heat emitters.
- Underfloor heating has the best performance with the heat pump system.

5.3 Setting up an auxiliary heat source for space heating

- Space heating can be done by:
 - The indoor unit
 - An auxiliary boiler (field supply) connected to the system
- When there is a heating request, the indoor unit or the auxiliary boiler starts operating. Which of these units operates, depends on the outdoor temperature (status of the changeover to external heat source). When the permission is given to the auxiliary boiler, the space heating by the indoor unit is turned OFF.
- Bivalent operation is only possible if:
 - Space heating is turned ON, and
 - DHW tank operation is turned OFF
- Domestic hot water is always produced by the DHW tank connected to the indoor unit.



INFORMATION

- During heating operation of the heat pump, the heat pump operates to achieve the desired temperature set via the user interface. When weather-dependent operation is active, the water temperature is determined automatically depending on the outdoor temperature.
- During heating operation of the auxiliary boiler, the auxiliary boiler operates to achieve the desired water temperature set via the auxiliary boiler controller.

Setup

- Integrate the auxiliary boiler as follows:

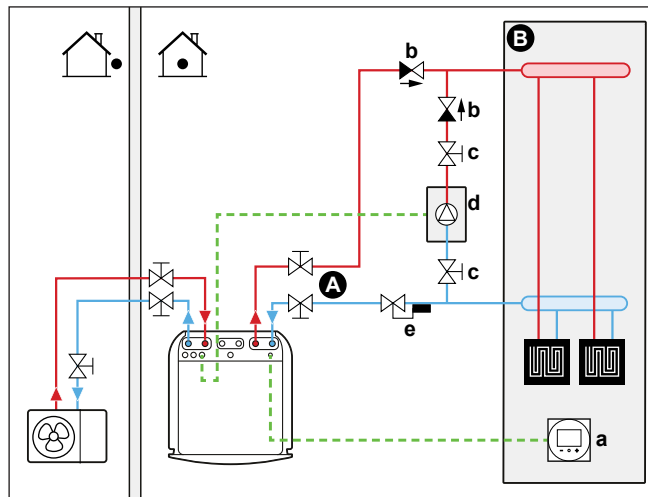

- A** Main leaving water temperature zone
- B** One single room
- a** Dedicated Human Comfort Interface (BRC1HHDA used as room thermostat)
- b** Non-return valve (field supply)
- c** Shut-off valve (field supply)
- d** Auxiliary boiler (field supply)
- e** Aquastat valve (field supply)



NOTICE

- Make sure the auxiliary boiler and its integration in the system complies with applicable legislation.
- Daikin is NOT responsible for incorrect or unsafe situations in the auxiliary boiler system.

- Make sure the return water to the heat pump does NOT exceed 60°C. To do so:
 - Set the desired water temperature via the auxiliary boiler controller to maximum 60°C.
 - Install an aquastat valve in the return water flow of the heat pump. Set the aquastat valve to close above 60°C and to open below 60°C.
- Install non-return valves.
- An expansion vessel is already pre-mounted in the indoor unit. But for bivalent operation, also make sure that there is an expansion vessel in the auxiliary boiler loop. Otherwise when bivalent operation is running and if the Aquastat valve would close, there would be no expansion vessel in the water circuit anymore.
- Install the digital I/O PCB (option EKR1HBAA).
- Connect X1 and X2 (changeover to external heat source) on the digital I/O PCB to the auxiliary boiler. See ["To connect the changeover to external heat source"](#) [▶ 110].
- To setup the heat emitters, see ["5.2 Setting up the space heating/cooling system"](#) [▶ 27].

Configuration

Via the user interface (configuration wizard):

- Set the use of a bivalent system as external heat source.
- Set the bivalent temperature and hysteresis.
- Set the operation mode to space heating only (no tank operation).

5.4 Setting up the domestic hot water tank

5.4.1 System layout – Integrated DHW tank

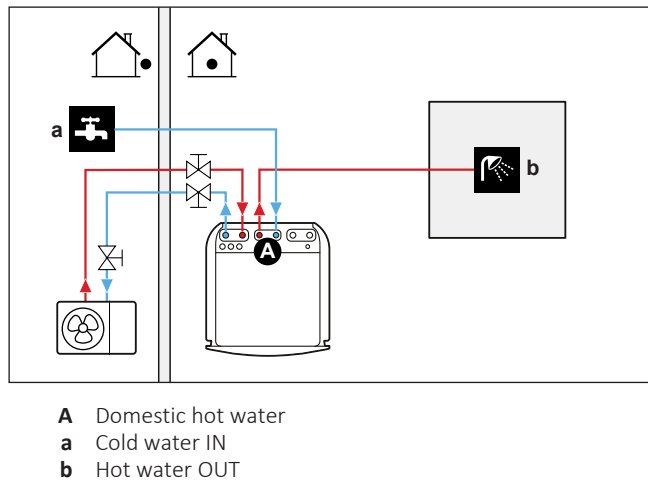

5.4.2 Selecting the volume and desired temperature for the DHW tank

People experience water as hot when its temperature is 40°C. Therefore, the DHW consumption is always expressed as equivalent hot water volume at 40°C. However, you can set the DHW tank temperature at a higher temperature (example: 53°C), which is then mixed with cold water (example: 15°C).

Selecting the volume and desired temperature for the DHW tank consists of:

- 1 Determining the DHW consumption (equivalent hot water volume at 40°C).
- 2 Determining the volume and desired temperature for the DHW tank.

Determining the DHW consumption

Answer the following questions and calculate the DHW consumption (equivalent hot water volume at 40°C) using typical water volumes:

Question	Typical water volume
How many showers are needed per day?	1 shower = 10 min×10 l/min = 100 l
How many baths are needed per day?	1 bath = 150 l
How much water is needed at the kitchen sink per day?	1 sink = 2 min×5 l/min = 10 l
Are there any other domestic hot water needs?	—

Example: If the DHW consumption of a family (4 persons) per day is as follows:

- 3 showers
- 1 bath
- 3 sink volumes

Then the DHW consumption = (3×100 l)+(1×150 l)+(3×10 l)=480 l

Determining the volume and desired temperature for the DHW tank

Formula	Example
$V_1 = V_2 + V_2 \times (T_2 - 40) / (40 - T_1)$	If: <ul style="list-style-type: none"> ▪ $V_2 = 180$ l ▪ $T_2 = 54^\circ\text{C}$ ▪ $T_1 = 15^\circ\text{C}$ Then $V_1 = 280$ l
$V_2 = V_1 \times (40 - T_1) / (T_2 - T_1)$	If: <ul style="list-style-type: none"> ▪ $V_1 = 480$ l ▪ $T_2 = 54^\circ\text{C}$ ▪ $T_1 = 15^\circ\text{C}$ Then $V_2 = 307$ l

V_1 DHW consumption (equivalent hot water volume at 40°C)

V_2 Required DHW tank volume if only heated once

T_2 DHW tank temperature

T_1 Cold water temperature

Possible DHW tank volumes

Type	Possible volumes
Integrated DHW tank	<ul style="list-style-type: none"> ▪ 180 l ▪ 230 l

Energy saving tips

- If the DHW consumption differs from day to day, you can program a weekly schedule with different desired DHW tank temperatures for each day.
- The lower the desired DHW tank temperature, the more cost effective. By selecting a larger DHW tank, you can lower the desired DHW tank temperature.
- The heat pump itself can produce domestic hot water of maximum 55°C (50°C if outdoor temperature is low). The electrical resistance integrated in the heat pump can increase this temperature. However, this consumes more energy. We recommend to set the desired DHW tank temperature below 55°C to avoid using the electrical resistance.
- The higher the outdoor temperature, the better the performance of the heat pump.
 - If energy prices are the same during the day and the night, we recommend to heat up the DHW tank during the day.
 - If energy prices are lower during the night, we recommend to heat up the DHW tank during the night.
- When the heat pump produces domestic hot water, it cannot heat up a space. In case you need domestic hot water and space heating at the same, we recommend to produce the domestic hot water during the night when there is lower space heating demand.

5.4.3 Setup and configuration – DHW tank

- For large DHW consumptions, you can heat up the DHW tank several times during the day.
- To heat up the DHW tank to the desired DHW tank temperature, you can use the following energy sources:
 - Thermodynamic cycle of the heat pump
 - Electrical backup heater
- For more information about optimizing the energy consumption for producing domestic hot water, see "[9 Configuration](#)" [▶ 115].

5.4.4 DHW pump for instant hot water

Setup

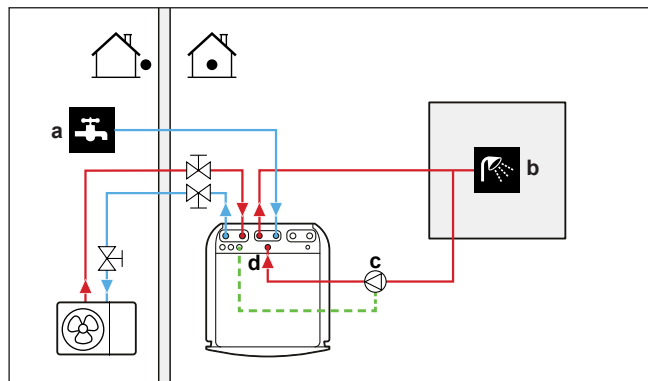

- a** Cold water IN
- b** Hot water OUT (shower (field supply))
- c** DHW pump (field supply)
- d** Recirculation connection

- By connecting a DHW pump, instant hot water can be available at the tap.
- The DHW pump and the installation are field supply and the responsibility of the installer. For the electrical wiring, see "[To connect the domestic hot water pump](#)" [▶ 107].

For more information about connecting the recirculation connection, see "[To connect the recirculation piping](#)" [▶ 82].

Configuration

- For more information, see "[9 Configuration](#)" [▶ 115].
- You can program a schedule to control the DHW pump via the user interface. For more information, see the user reference guide.

5.4.5 DHW pump for disinfection

Setup

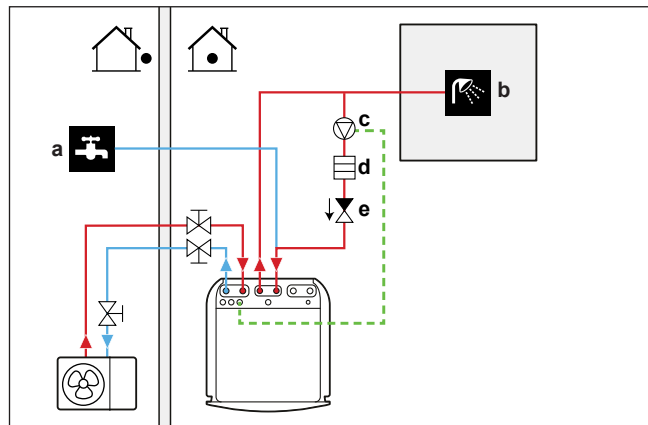

- a Cold water IN
- b Hot water OUT (shower (field supply))
- c DHW pump (field supply)
- d Heater element (field supply)
- e Non-return valve (field supply)

- The DHW pump is field-supplied and its installation is the responsibility of the installer. For the electrical wiring, see "[To connect the domestic hot water pump](#)" [▶ 107].
- If the applicable legislation requires a higher temperature than the maximum tank setpoint during disinfection (see [2-03] in the field settings table), you can connect a DHW pump and heater element as shown above.
- If applicable legislation requires disinfection of the water piping until the tapping point, you can connect a DHW pump and heater element (if needed) as shown above.

Configuration

The indoor unit can control DHW pump operation. For more information, see "[9 Configuration](#)" [▶ 115].

5.5 Setting up the energy metering

- Via the user interface, you can read out the following energy data:
 - Produced heat
 - Consumed energy
- You can read out the energy data:
 - For space heating
 - For space cooling
 - For domestic hot water production
- You can read out the energy data:
 - Per month
 - Per year



INFORMATION

The calculated produced heat and consumed energy are an estimation, the accuracy cannot be guaranteed.

5.5.1 Produced heat



INFORMATION

The sensors used to calculate the produced heat are calibrated automatically.



INFORMATION

If glycol is present in the system ([E-OD]=1)), then the produced heat will NOT be calculated, nor will it be displayed on the user interface.

- The produced heat is calculated internally based on:
 - The leaving and entering water temperature
 - The flow rate
- Setup and configuration: No additional equipment needed.

5.5.2 Consumed energy

You can use the following methods to determine the consumed energy:

- Calculating
- Measuring



INFORMATION

You cannot combine calculating the consumed energy (example: for backup heater) and measuring the consumed energy (example: for outdoor unit). If you do so, the energy data will be invalid.

Calculating the consumed energy

- The consumed energy is calculated internally based on:
 - The actual power input of the outdoor unit
 - The set capacity of the backup heater
 - The voltage
- Setup and configuration: To get accurate energy data, measure the capacity (resistance measurement) and set the capacity via the user interface for the backup heater (step 1).

Measuring the consumed energy

- Preferred method because of higher accuracy.
- Requires external power meters.
- Setup and configuration: When using electrical power meters, set the number of pulses/kWh for each power meter via the user interface.



INFORMATION

When measuring the electrical power consumption, make sure ALL power input of the system is covered by the electrical power meters.

5.5.3 Normal kWh rate power supply

General rule

One power meter that covers the entire system is sufficient.

Setup

Connect the power meter to X5M/5 and X5M/6. See "To connect the electricity meters" [▶ 106].

Power meter type

In case of...	Use a... power meter
<ul style="list-style-type: none"> Single-phase outdoor unit Backup heater supplied from a single-phase grid (i.e. the backup heater model is *3V or *6V connected to a single-phase grid) 	Single-phase (*3V, *6V (6V): 1N~ 230 V)
<ul style="list-style-type: none"> Three-phase outdoor unit Backup heater supplied from a three-phase grid (i.e. the backup heater model is *9W or *6V connected to a three-phase grid) 	Three-phase (*6V (6T1): 3~ 230 V) (*9W: 3N~ 400 V)

Example

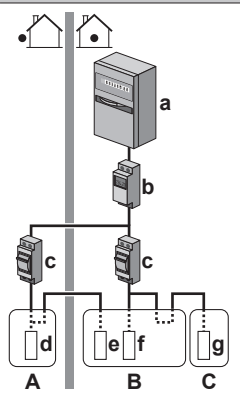
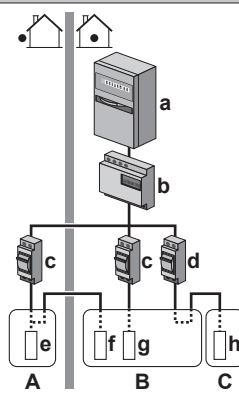
Single-phase power meter	Three-phase power meter
 <p>The diagram shows a single-phase power supply from a utility pole to an electrical cabinet (a). A power meter (b) is connected to the cabinet. The power is then distributed through a fuse (c) to three indoor units: A (Outdoor unit), B (Indoor unit), and C (DHW tank). Each indoor unit has its own fuse (d, e, f) and is connected to a booster heater (g).</p>	 <p>The diagram shows a three-phase power supply from a utility pole to an electrical cabinet (a). A power meter (b) is connected to the cabinet. The power is then distributed through three fuses (c, c, d) to three indoor units: A (Outdoor unit), B (Indoor unit), and C (DHW tank). Each indoor unit has its own fuse (e, f, g) and is connected to a booster heater (h).</p>
<p>A Outdoor unit B Indoor unit C DHW tank a Electrical cabinet (L₁/N) b Power meter (L₁/N) c Fuse (L₁/N) d Outdoor unit (L₁/N) e Indoor unit (L₁/N) f Backup heater (L₁/N) g Booster heater (L₁/N)</p>	<p>A Outdoor unit B Indoor unit C DHW tank a Electrical cabinet (L₁/L₂/L₃/N) b Power meter (L₁/L₂/L₃/N) c Fuse (L₁/L₂/L₃/N) d Fuse (L₁/N) e Outdoor unit (L₁/L₂/L₃/N) f Indoor unit (L₁/L₂/L₃/N) g Backup heater (L₁/L₂/L₃/N) h Booster heater (L₁/N)</p>

Exception

- You can use a second power meter if:
 - The power range of one meter is insufficient.
 - The electrical meter cannot easily be installed in the electrical cabinet.
 - 230 V and 400 V three-phase grids are combined (very uncommon), because of technical limitations of power meters.
- Connection and setup:
 - Connect the second power meter to X5M/3 and X5M/4. See ["To connect the electricity meters"](#) [▶ 106].
 - In the software the power consumption data of both meters is added so you do NOT have to set which meter covers which power consumption. You only need to set the number of pulses of each power meter.
- See ["Preferential kWh rate power supply"](#) [▶ 48] for an example with two power meters.

5.5.4 Preferential kWh rate power supply

General rule

- Power meter 1: Measures the outdoor unit.
- Power meter 2: Measures the rest (i.e. indoor unit and backup heater).

Setup

- Connect power meter 1 to X5M/5 and X5M/6.
- Connect power meter 2 to X5M/3 and X5M/4.

See ["To connect the electricity meters"](#) [▶ 106].

Power meter types

- Power meter 1: Single- or three-phase power meter according to the power supply of the outdoor unit.
- Power meter 2:
 - In case of a single-phase backup heater configuration, use a single-phase power meter.
 - In other cases, use a three-phase power meter.

Example

Single-phase outdoor unit with a three-phase backup heater:

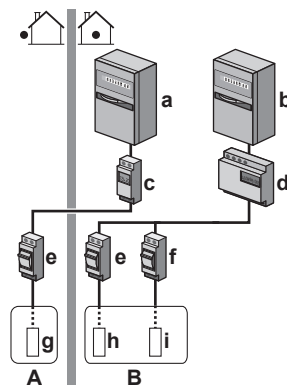

- A** Outdoor unit
- B** Indoor unit
- C** DHW tank

- a Electrical cabinet (L₁/N): Preferential kWh rate power supply
- b Electrical cabinet (L₁/L₂/L₃/N): Normal kWh rate power supply
- c Power meter (L₁/N)
- d Power meter (L₁/L₂/L₃/N)
- e Fuse (L₁/N)
- f Fuse (L₁/L₂/L₃/N)
- g Outdoor unit (L₁/N)
- h Indoor unit (L₁/N)
- i Backup heater (L₁/L₂/L₃/N)

5.6 Setting up the power consumption control

You can use the following power consumption controls. For more information about the corresponding settings, see ["Power consumption control"](#) [▶ 185].

#	Power consumption control
1	<p>"Permanent power limitation" [▶ 49]</p> <ul style="list-style-type: none"> ▪ Allows you to limit the power consumption of the entire heat pump system (sum of indoor unit and backup heater) with one permanent setting. ▪ Limitation of power in kW or current in A.
2	<p>"Power limitation activated by digital inputs" [▶ 50]</p> <ul style="list-style-type: none"> ▪ Allows you to limit the power consumption of the entire heat pump system (sum of indoor unit and backup heater) via 4 digital inputs. ▪ Limitation of power in kW or current in A.
3	<p>"BBR16 power limitation" [▶ 52]</p> <ul style="list-style-type: none"> ▪ Restriction: Only available in Swedish language. ▪ Allows you to comply with BBR16 regulations (Swedish energy regulations). ▪ Limitation of power in kW. ▪ Can be combined with the other kW power consumption controls. If you do so, the unit uses the most restrictive control.



NOTICE

It is possible to install a field fuse with lower than recommended rating over the heat pump. For this you must modify field setting [2-0E] according to the maximum allowed current over the heat pump.

Note that field setting [2-0E] overrules all power consumption control settings. Power limiting the heat pump will reduce performance.



NOTICE

Set a minimum power consumption of ±3.6 kW to guarantee:

- Defrost operation. Otherwise, if defrosting is interrupted several times, the heat exchanger will freeze up.
- Space heating and DHW production by allowing the backup heater step 1.

5.6.1 Permanent power limitation

Permanent power limitation is useful to assure a maximum power or current input of the system. In some countries, legislation limits the maximum power consumption for space heating and DHW production.

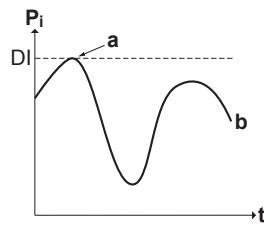

- P_i** Power input
- t** Time
- DI** Digital input (power limitation level)
- a** Power limitation active
- b** Actual power input

Setup and configuration

- No additional equipment needed.
- Set the power consumption control settings in [9.9] via the user interface (see "Power consumption control" [▶ 185]):
 - Select continuous limitation mode
 - Select the type of limitation (power in kW or current in A)
 - Set the desired power limitation level

5.6.2 Power limitation activated by digital inputs

Power limitation is also useful in combination with an energy management system. The power or current of the entire Daikin system is limited dynamically by digital inputs (maximum four steps). Each power limitation level is set via the user interface by limiting one of the following:

- Current (in A)
- Power input (in kW)

The energy management system (field supply) decides the activation of a certain power limitation level. **Example:** To limit the maximum power of the entire house (lighting, domestic appliances, space heating...).

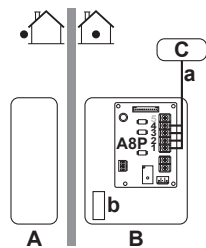

- A** Outdoor unit
- B** Indoor unit
- C** Energy management system
- a** Power limitation activation (4 digital inputs)
- b** Backup heater

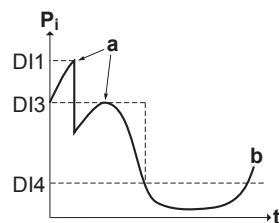

- P_i** Power input
- t** Time
- DI** Digital inputs (power limitation levels)

- a** Power limitation active
- b** Actual power input

Setup

- Demand PCB (option EGRP1AHTA) needed.
- Maximum four digital inputs are used to activate the corresponding power limitation level:
 - DI1 = strongest limitation (lowest energy consumption)
 - DI4 = weakest limitation (highest energy consumption)
- Specification of the digital inputs:
 - DI1: S9S (limit 1)
 - DI2: S8S (limit 2)
 - DI3: S7S (limit 3)
 - DI4: S6S (limit 4)
- Refer to the wiring diagram for more information.

Configuration

- Set the power consumption control settings in [9.9] via the user interface (for the description of all settings, see "[Power consumption control](#)" [▶ 185]):
 - Select limitation by digital inputs.
 - Select the type of limitation (power in kW or current in A).
 - Set the desired power limitation level corresponding to each digital input.



INFORMATION

In case more than 1 digital input is closed (at the same time), the digital input priority is fixed: DI4 priority>...>DI1.

5.6.3 Power limitation process

The outdoor unit has better efficiency than the electrical heater. Therefore, the electrical heater is limited and turned OFF first. The system limits power consumption in the following order:

- 1 Turns OFF the backup heater.
- 2 Limits the outdoor unit.
- 3 Turns OFF the outdoor unit.

Example

If the configuration is as follows: Power limitation level does NOT allow operation of backup heater (step 1).

Then power consumption is limited as follows:

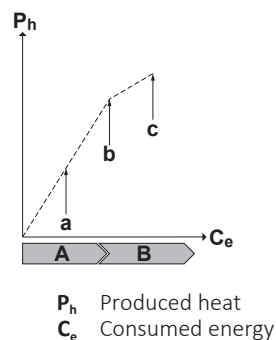

- A Outdoor unit
- B Backup heater
- a Limited outdoor unit operation
- b Full outdoor unit operation
- c Backup heater step 1 turned ON

5.6.4 BBR16 power limitation



INFORMATION

Restriction: BBR16 settings are only visible when the language of the user interface is set to Swedish.



NOTICE

2 weeks to change. After you activated BBR16, you only have 2 weeks to change its settings (**BBR16 activation** and **BBR16 power limit**). After 2 weeks, the unit freezes these settings.

Note: This is different from the permanent power limitation, which is always changeable.

Use the BBR16 power limitation when you must comply with BBR16 regulations (Swedish energy regulations).

You can combine the BBR16 power limitation with the other kW power consumption controls. If you do so, the unit uses the most restrictive control.

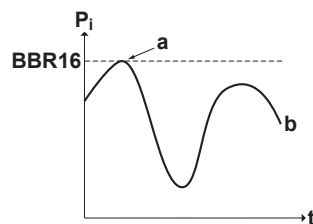

- P_i Power input
- t Time
- BBR16** BBR16 limit level
- a** Power limitation active
- b** Actual power input

Setup and configuration

- No additional equipment needed.
- Set the power consumption control settings in [9.9] via the user interface (see "Power consumption control" [▶ 185]):
 - Activate BBR16
 - Set the desired power limitation level

5.7 Setting up an external temperature sensor

You can connect one external temperature sensor. It measures the indoor or outdoor ambient temperature. We recommend to use an external temperature sensor in the following cases:

Indoor ambient temperature

- In room thermostat control, the dedicated Human Comfort Interface (BRC1HHDA used as room thermostat) measures the indoor ambient temperature. Therefore, the Human Comfort Interface must be installed on a location:
 - Where the average temperature in the room can be detected
 - That is NOT exposed to direct sunlight
 - That is NOT near a heat source
 - That is NOT affected by outside air or air draught because of, for example, door opening/closing
- If this is NOT possible, we recommend to connect a remote indoor sensor (option KRCSO1-1).
- Setup: For installation instructions, see the installation manual of the remote indoor sensor, and the addendum book for optional equipment.
- Configuration: Select room sensor [9.B].

Outdoor ambient temperature

- In the outdoor unit, the outdoor ambient temperature is measured. Therefore, the outdoor unit must be installed on a location:
 - At the north side of the house or at the side of the house where the most heat emitters are located
 - That is NOT exposed to direct sunlight
- If this is NOT possible, we recommend to connect a remote outdoor sensor (option EKRSCA1).
- Setup: For installation instructions, see the installation manual of the remote outdoor sensor, and the addendum book for optional equipment.
- Configuration: Select outdoor sensor [9.B].
- When the power saving functionality of the outdoor unit is active (see "[Power saving function](#)" [▶ 192]), the outdoor unit is turned down to reduce standby energy losses. As a result, the outdoor ambient temperature is NOT read out.
- If the desired leaving water temperature is weather dependent, the full time outdoor temperature measurement is important. This is another reason to install the optional outdoor ambient temperature sensor.



INFORMATION

The external outdoor ambient sensor data (either averaged or instantaneous) is used in the weather-dependent control curves and in the automatic heating/cooling changeover logic. To protect the outdoor unit, the internal sensor of the outdoor unit is always used.

6 Unit installation

In this chapter

6.1	Preparing the installation site	54
6.1.1	Installation site requirements of the outdoor unit	54
6.1.2	Additional installation site requirements of the outdoor unit in cold climates	57
6.1.3	Installation site requirements of the indoor unit	57
6.2	Opening and closing the units	58
6.2.1	About opening the units	58
6.2.2	To open the outdoor unit	58
6.2.3	To remove the transportation stay	59
6.2.4	To close the outdoor unit	59
6.2.5	To open the indoor unit	60
6.2.6	To lower the switch box on the indoor unit	62
6.2.7	To close the indoor unit	63
6.3	Mounting the outdoor unit	63
6.3.1	About mounting the outdoor unit	63
6.3.2	Precautions when mounting the outdoor unit	63
6.3.3	To provide the installation structure	63
6.3.4	To install the outdoor unit	64
6.3.5	To provide drainage	65
6.3.6	To install the discharge grille	67
6.3.7	To remove the discharge grille, and put the grille in safety position	68
6.4	Mounting the indoor unit	70
6.4.1	About mounting the indoor unit	70
6.4.2	Precautions when mounting the indoor unit	70
6.4.3	To install the indoor unit	70
6.4.4	To connect the drain hose to the drain	71

6.1 Preparing the installation site

Do NOT install the unit in places often used as work place. In case of construction works (e.g. grinding works) where a lot of dust is created, the unit MUST be covered.

Choose an installation location with sufficient space for carrying the unit in and out of the site.



WARNING

The appliance shall be stored in a room without continuously operating ignition sources (example: open flames, an operating gas appliance or an operating electric heater).

6.1.1 Installation site requirements of the outdoor unit



INFORMATION

Also read the precautions and requirements in the "[1 General safety precautions](#)" [[▶ 6](#)].

Mind the spacing guidelines. See "[15.1 Service space: Outdoor unit](#)" [[▶ 233](#)].



NOTICE

- Do NOT stack the units on each other.
- Do NOT hang the unit on a ceiling.

Strong winds (≥ 18 km/h) blowing against the outdoor unit's air outlet causes short circuit (suction of discharge air). This may result in:

- deterioration of the operational capacity;
- frequent frost acceleration in heating operation;
- disruption of operation due to decrease of low pressure or increase of high pressure;
- a broken fan (if a strong wind blows continuously on the fan, it may start rotating very fast, until it breaks).

It is recommended to install a baffle plate when the air outlet is exposed to wind.

It is recommended to install the outdoor unit with the air inlet facing the wall and NOT directly exposed to the wind.

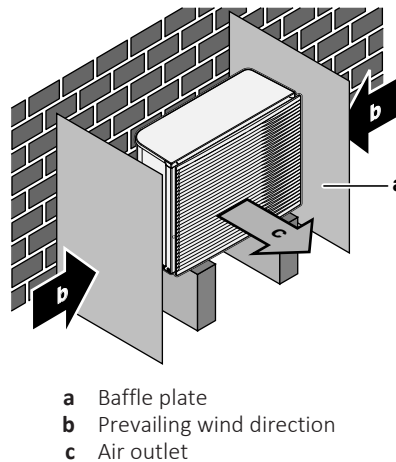

Do NOT install the unit in the following places:

- Sound sensitive areas (e.g. near a bedroom), so that the operation noise will cause no trouble.

Note: If the sound is measured under actual installation conditions, the measured value might be higher than the sound pressure level mentioned in Sound spectrum in the data book due to environmental noise and sound reflections.

- In places where a mineral oil mist, spray or vapour may be present in the atmosphere. Plastic parts may deteriorate and fall off or cause water leakage.

It is NOT recommended to install the unit in the following places because it may shorten the life of the unit:

- Where the voltage fluctuates a lot
- In vehicles or vessels
- Where acidic or alkaline vapour is present

Seaside installation. Make sure the outdoor unit is NOT directly exposed to sea winds. This is to prevent corrosion caused by high levels of salt in the air, which might shorten the life of the unit.

Install the outdoor unit away from direct sea winds.

Example: Behind the building.

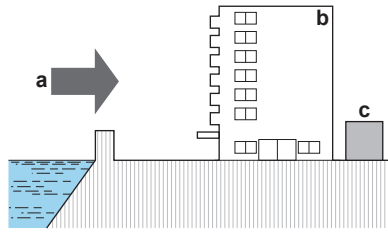

If the outdoor unit is exposed to direct sea winds, install a windbreaker.

- Height of windbreaker $\geq 1.5 \times$ height of outdoor unit
- Mind the service space requirements when installing the windbreaker.

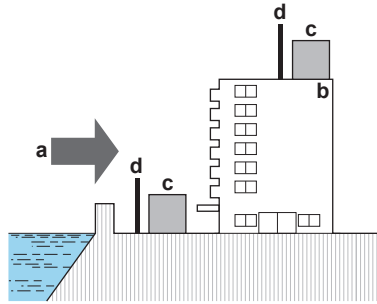

- a Sea wind
- b Building
- c Outdoor unit
- d Windbreaker

The outdoor unit is designed for outdoor installation only, and for the following ambient temperatures:

Cooling mode	10~43°C
Heating mode	-28~35°C

Special requirements for R32

The outdoor unit contains an internal refrigerant circuit (R32), but you do NOT have to do any refrigerant field piping, or refrigerant charging.

Mind the following requirements and precautions:



WARNING

- Do NOT pierce or burn.
- Do NOT use means to accelerate the defrosting process or to clean the equipment, other than those recommended by the manufacturer.
- Be aware that R32 refrigerant does NOT contain an odour.



WARNING

The appliance shall be stored so as to prevent mechanical damage and in a well-ventilated room without continuously operating ignition sources (example: open flames, an operating gas appliance or an operating electric heater).



WARNING

Make sure installation, servicing, maintenance and repair comply with instructions from Daikin and with applicable legislation (for example national gas regulation) and are executed only by authorised persons.

6.1.2 Additional installation site requirements of the outdoor unit in cold climates

Protect the outdoor unit against direct snowfall and take care that the outdoor unit is NEVER snowed up.

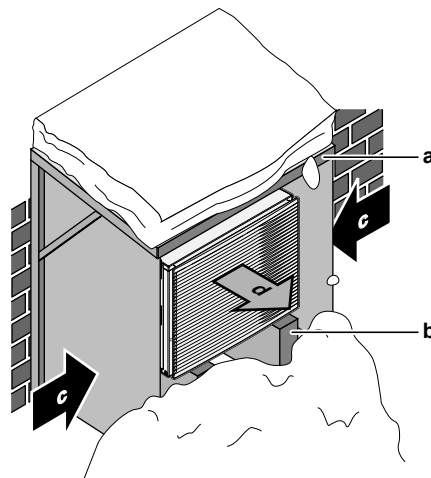

- a Snow cover or shed
- b Pedestal
- c Prevailing wind direction
- d Air outlet

In any case, provide at least 150 mm of free space below the unit. Additionally, make sure the unit is positioned at least 100 mm above the maximum expected level of snow. See "6.3 Mounting the outdoor unit" [▶ 63] for more details.

In heavy snowfall areas it is very important to select an installation site where the snow will NOT affect the unit. If lateral snowfall is possible, make sure that the heat exchanger coil is NOT affected by the snow. If necessary, install a snow cover or shed and a pedestal.

6.1.3 Installation site requirements of the indoor unit



INFORMATION

Also read the precautions and requirements in the "1 General safety precautions" [▶ 6].

- The indoor unit is designed for indoor installation only and for the following ambient temperatures:
 - Space heating operation: 5~30°C
 - Space cooling operation: 5~35°C
 - Domestic hot water production: 5~35°C



INFORMATION

Cooling is only applicable in case of:

- Reversible models
- Heating only models + conversion kit (EKHVCONV2)

- Mind the measurement guidelines:

Maximum height difference between indoor unit and outdoor unit	10 m
Maximum total water piping length	50 m ^(a)

^(a) Precise water piping length can be determined using the Hydronic Piping Calculation tool. The Hydronic Piping Calculation tool is part of the Heating Solutions Navigator which can be reached via <https://professional.standbyme.daikin.eu>. Please contact your dealer if you have no access to Heating Solutions Navigator.

- Mind the following spacing installation guidelines:

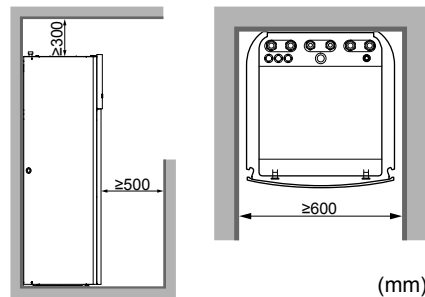

INFORMATION

If you have limited installation space, do the following before installing the unit in its final position: "To connect the drain hose to the drain" [▶ 71]. It requires to remove one or both side panels.

- The foundation must be strong enough to bear the weight of the unit. Take the weight of the unit with a domestic hot water tank full of water into account. Make sure, in the event of a water leak, water cannot cause any damage to the installation space and surroundings.

Do NOT install the unit in places such as:

- In places where a mineral oil mist, spray or vapour may be present in the atmosphere. Plastic parts may deteriorate and fall off or cause water leakage.
- Sound sensitive areas (e.g. near a bedroom), so that the operation noise will cause no trouble.
- In places with high humidity (max. RH=85%), for example a bathroom.
- In places where frost is possible. Ambient temperature around the indoor unit must be >5°C.

6.2 Opening and closing the units

6.2.1 About opening the units

At certain times, you have to open the unit. **Example:**

- When connecting the electrical wiring
- When maintaining or servicing the unit



DANGER: RISK OF ELECTROCUTION

Do NOT leave the unit unattended when the service cover is removed.

6.2.2 To open the outdoor unit



DANGER: RISK OF ELECTROCUTION



DANGER: RISK OF BURNING/SCALDING

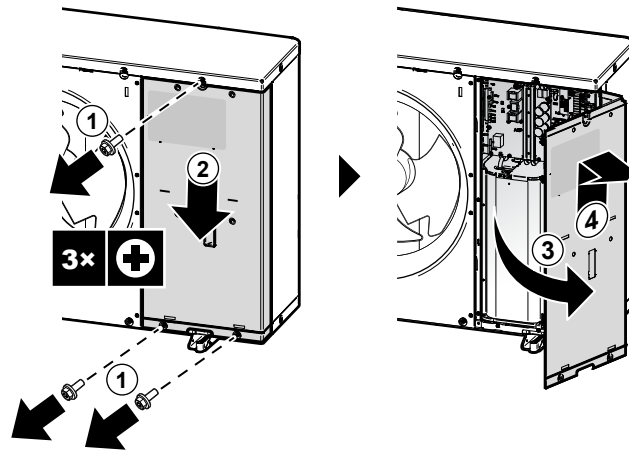

6.2.3 To remove the transportation stay



NOTICE

If the unit is operated with the transportation stay attached, abnormal vibration or noise may be generated.

The transportation stays (2x) protect the unit during transport. During installation they must be removed.

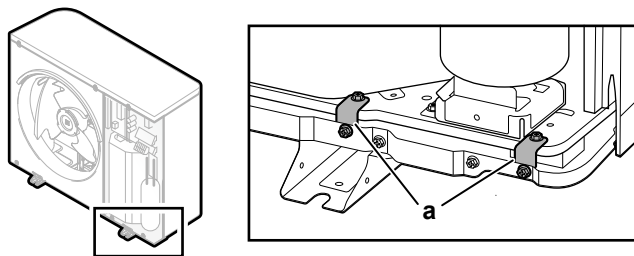

a Transportation stays (2x)

- 1 Open the switch box cover. See "[To open the outdoor unit](#)" [▶ 58].
- 2 Remove the screws (4x) from the transportation stays, and dispose of them.
- 3 Remove the transportation stays (2x), and dispose of them.

6.2.4 To close the outdoor unit



NOTICE

When closing the outdoor unit cover, make sure that the tightening torque does NOT exceed 4.1 N•m.

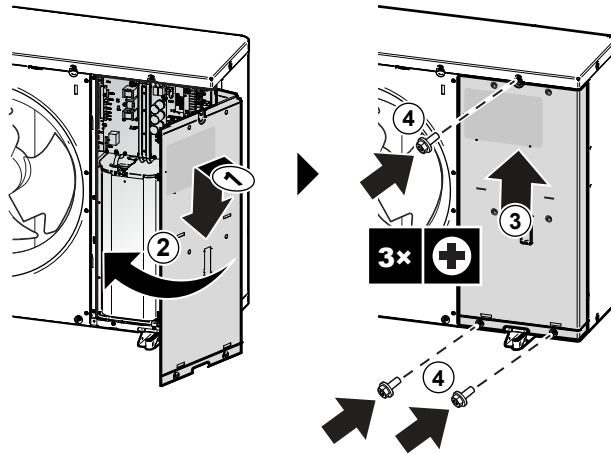

6.2.5 To open the indoor unit

Overview

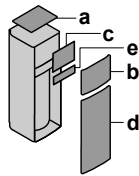

- a Top panel
- b User interface panel
- c Switch box cover
- d Front panel
- e High voltage switch box cover

Open

- 1 Remove the top panel.

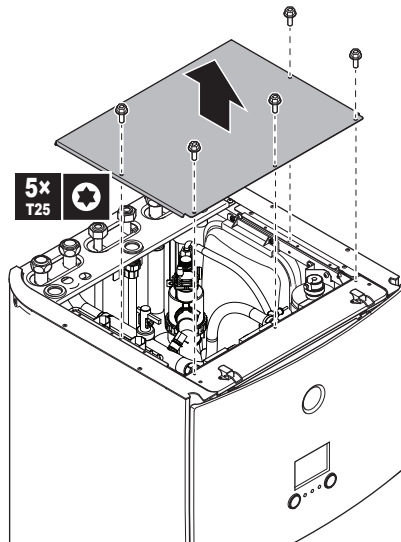

- 2 Remove the user interface panel. Open the hinges at the top and slide the top panel upwards.



NOTICE

If you remove the user interface panel, also disconnect the cables from the back of the user interface panel to prevent damage.

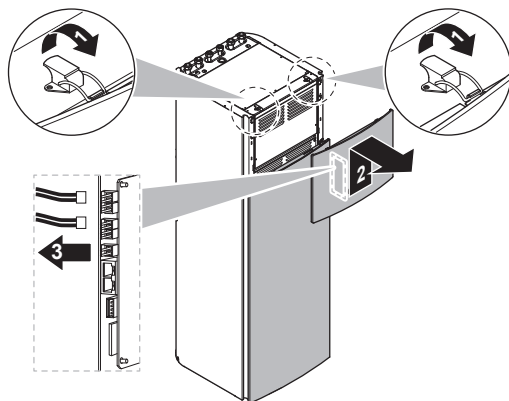

- 3** Remove the switch box cover.

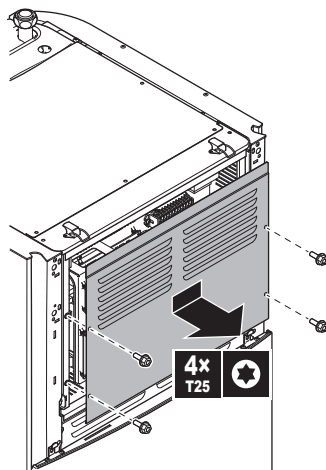

- 4** If necessary, remove the front plate. This is, for example, necessary in the following cases:
- "To lower the switch box on the indoor unit" [[▶ 62](#)]
 - "To connect the drain hose to the drain" [[▶ 71](#)]
 - When you need access to the high voltage switch box

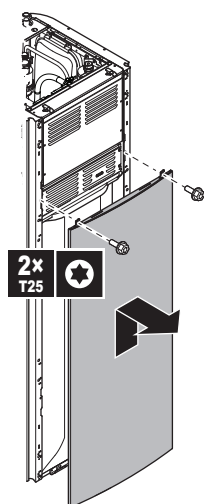

- 5** If you need access to the high voltage components, remove the high voltage switch box cover.

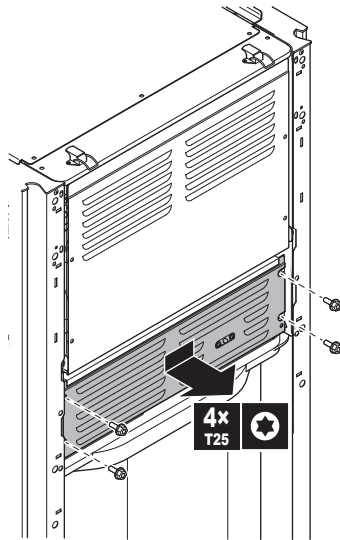

6.2.6 To lower the switch box on the indoor unit

During the installation, you will need access to the inside of the indoor unit. To have easier front access, put the switch box lower on the unit as follows:

Prerequisite: The user interface panel and front panel have been removed.

- 1 Remove the fixing plate at the top of the unit.
- 2 Tilt the switch box to the front and lift it out of its hinges.

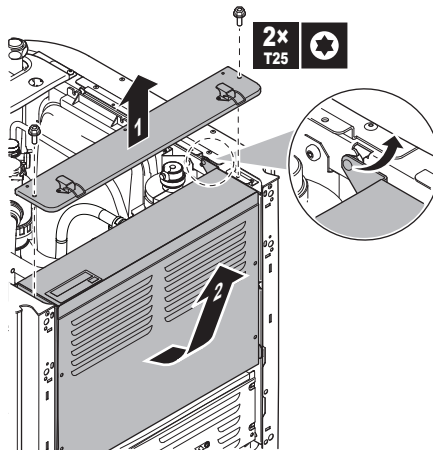

- 3 Place the switch box lower on the unit. Use the 2 hinges located lower on the unit.

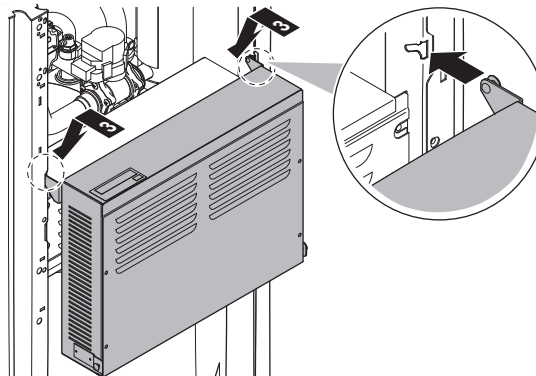

6.2.7 To close the indoor unit

- 1 Close the cover of the switch box.
- 2 Put the switch box back into place.
- 3 Reinstall the top panel.
- 4 Reinstall the side panels.
- 5 Reinstall the front panel.
- 6 Reconnect the cables to the user interface panel.
- 7 Reinstall the user interface panel.



NOTICE

When closing the indoor unit cover, make sure that the tightening torque does NOT exceed 4.1 N•m.

6.3 Mounting the outdoor unit

6.3.1 About mounting the outdoor unit

When

You have to mount the outdoor unit before you can connect the water piping.

Typical workflow

Mounting the outdoor unit typically consists of the following stages:

- 1 Providing the installation structure.
- 2 Installing the outdoor unit.
- 3 Providing drainage.
- 4 Installing the discharge grille.
- 5 Protecting the unit against snow and wind by installing a snow cover and baffle plates. See "[6.1 Preparing the installation site](#)" [[▶ 54](#)].

6.3.2 Precautions when mounting the outdoor unit



INFORMATION

Also read the precautions and requirements in the following chapters:

- "[1 General safety precautions](#)" [[▶ 6](#)]
- "[6.1 Preparing the installation site](#)" [[▶ 54](#)]

6.3.3 To provide the installation structure

Check the strength and level of the installation ground so that the unit will not cause any operating vibration or noise.

Fix the unit securely by means of foundation bolts in accordance with the foundation drawing.

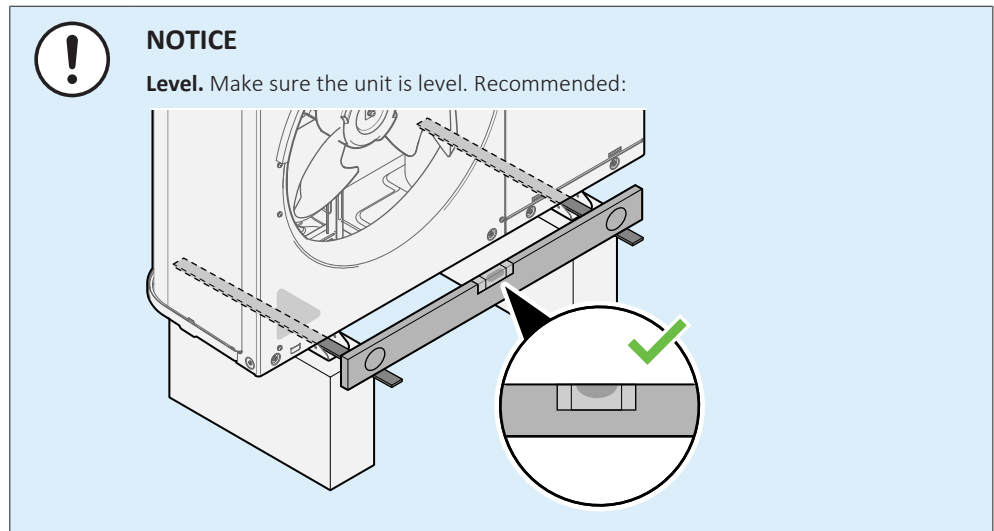

Use 4 sets of M12 anchor bolts, nuts and washers. Provide at least 150 mm of free space below the unit. Additionally, make sure the unit is positioned at least 100 mm above the maximum expected level of snow.

Anchor points

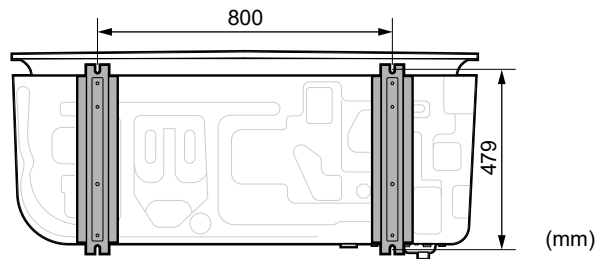

Pedestal

When installing on a pedestal, make sure that the discharge grille still can be put in its safety position. See "To remove the discharge grille, and put the grille in safety position" [▶ 68].

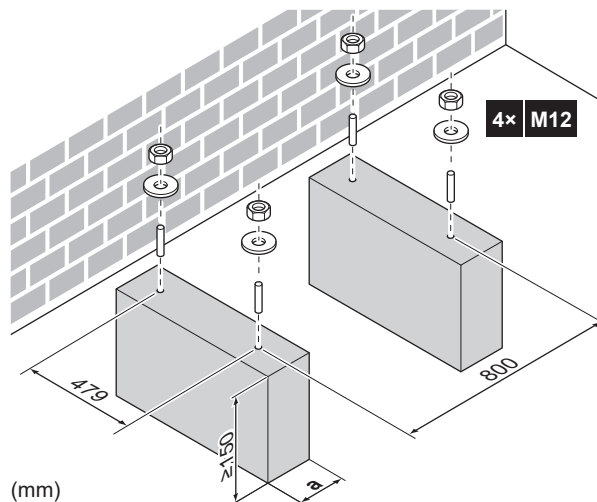

a Make sure not to cover the drain hole in the bottom plate of the unit.

6.3.4 To install the outdoor unit

- 1 Carry the unit by its slings, and put it onto the installation structure.

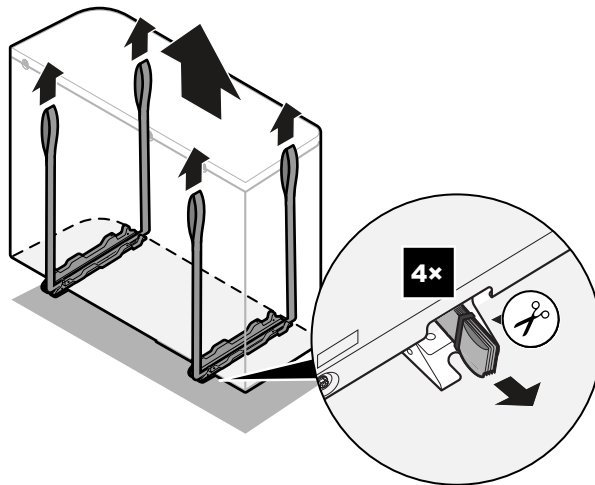
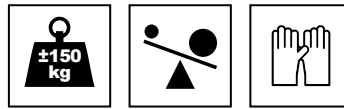

2 Fix the unit to the installation structure.

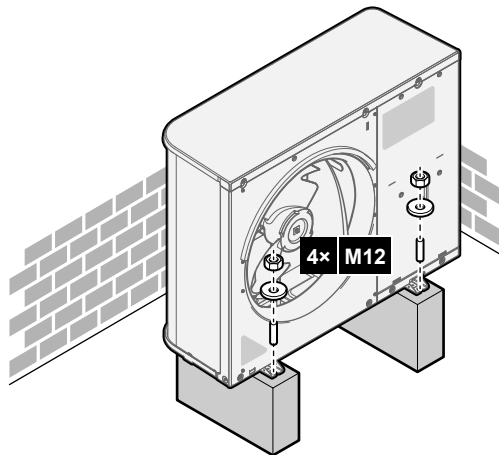

3 Remove the slings (and screws), and dispose of them.

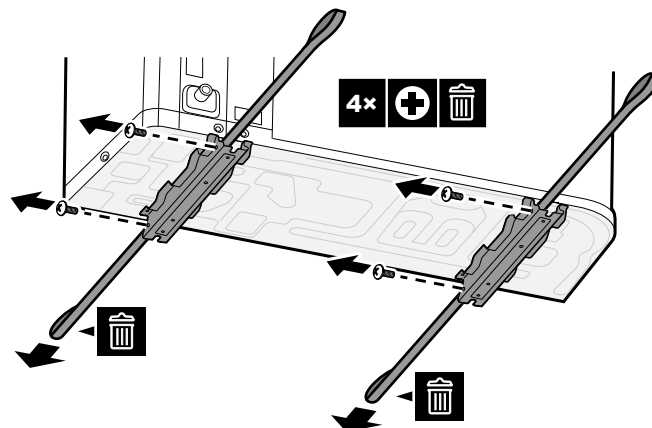

6.3.5 To provide drainage

- Make sure that condensation water can be evacuated properly.
- Install the unit on a base to make sure that there is proper drainage in order to avoid ice accumulation.
- Prepare a water drainage channel around the foundation to drain waste water away from the unit.

- Avoid drain water flowing over the footpath, so that it does NOT become slippery in case of ambient freezing temperatures.
- If you install the unit on a frame, install a waterproof plate within 150 mm of the bottom side of the unit in order to prevent water from getting into the unit and to avoid drain water dripping (see the following figure).



NOTICE

If the unit is installed in a cold climate, take adequate measures so that the evacuated condensate CANNOT freeze. We recommend to do the following:

- Insulate the drain hose.
- Install a drain tube heater (field supply). To connect the drain tube heater, see "To connect the electrical wiring to the outdoor unit" [p. 91].



NOTICE

Provide at least 150 mm of free space below the unit. Additionally, make sure the unit is positioned at least 100 mm above the expected level of snow.

Use the drain plug (with O-ring) and a hose for drainage.

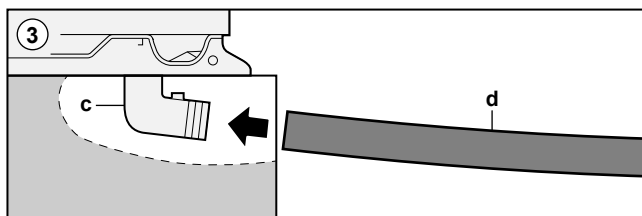
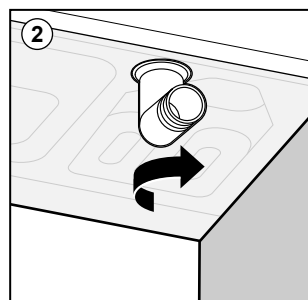
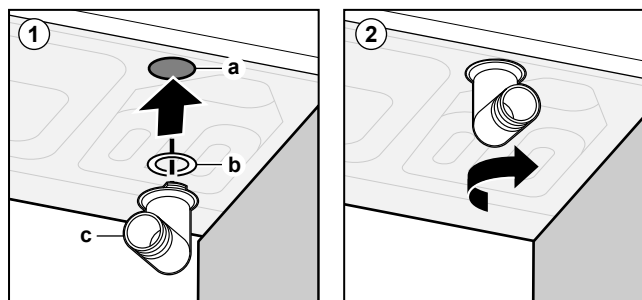
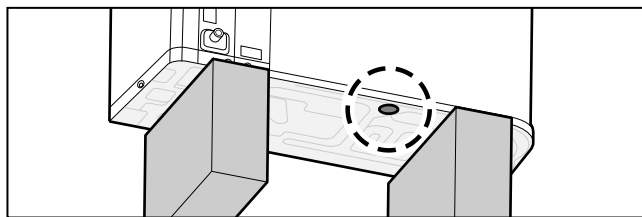

- a Drain hole
- b O-ring (delivered as accessory)
- c Drain plug (delivered as accessory)
- d Hose (field supply)



NOTICE

O-ring. Make sure the O-ring is installed correctly to prevent leakage.

6.3.6 To install the discharge grille

**INFORMATION**

Electrical wiring. Before installing the discharge grille, connect the electrical wiring.

Install the lower part of the discharge grille

- 1 Insert the hooks.
- 2 Insert the ball studs.

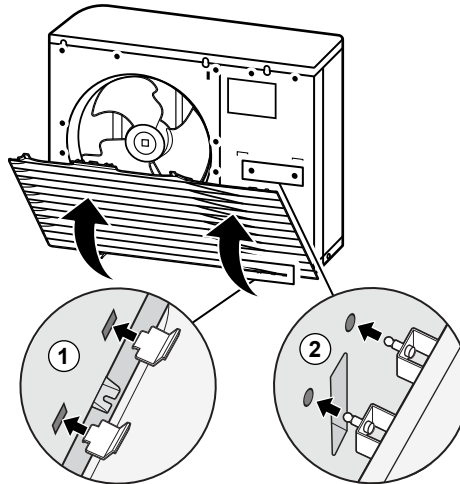

- 3 Fix the 2 lower screws.

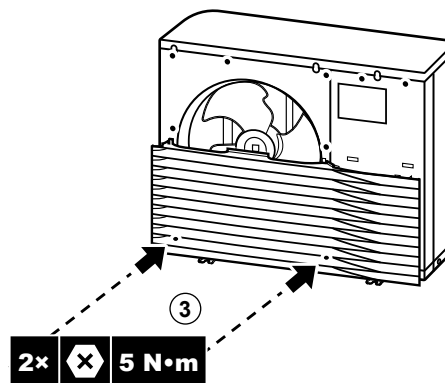
**Install the upper part of the discharge grille****NOTICE**

Vibrations. Make sure the upper part of the discharge grille is attached seamlessly to the lower part to prevent vibrations.

- 4 Align and attach the left side.
- 5 Align and attach the middle part.
- 6 Align and attach the right side.

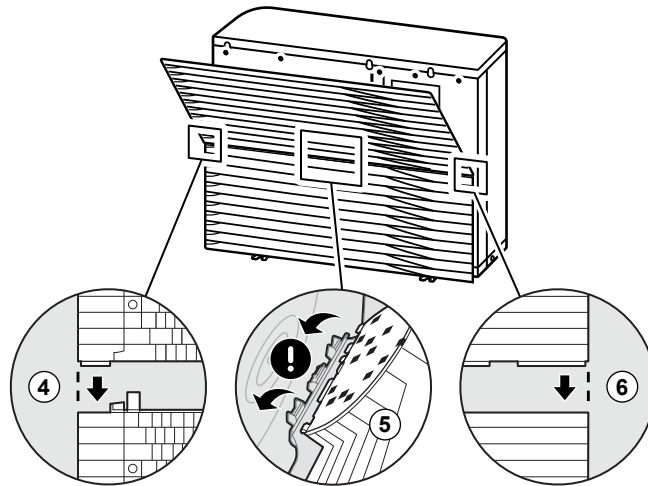

- 7 Insert the hooks.
- 8 Insert the ball studs.

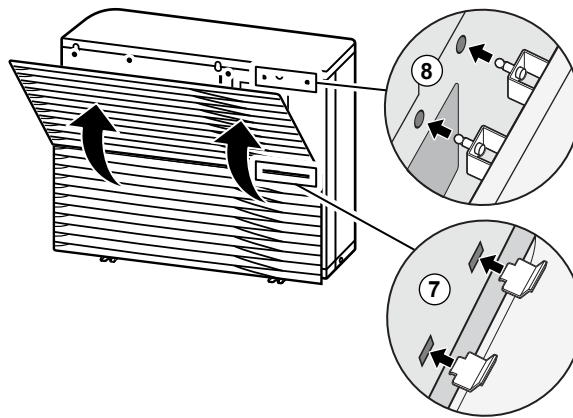

- 9 Fix the 6 remaining screws.

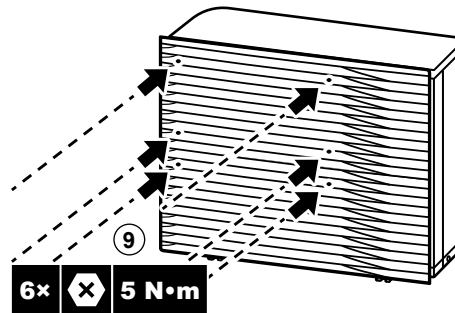

6.3.7 To remove the discharge grille, and put the grille in safety position

 **WARNING**
Rotating fan. Before powering ON or servicing the outdoor unit, make sure that the discharge grille covers the fan as protection against a rotating fan. See:

- "To install the discharge grille" ▶ 67]
- "To remove the discharge grille, and put the grille in safety position" ▶ 68]

- 1 Remove the upper part of the discharge grille.

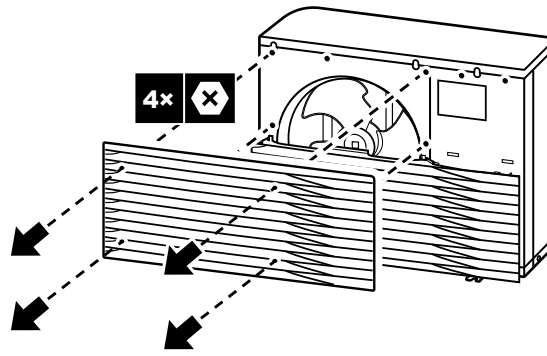

- 2 Remove the lower part of the discharge grille.

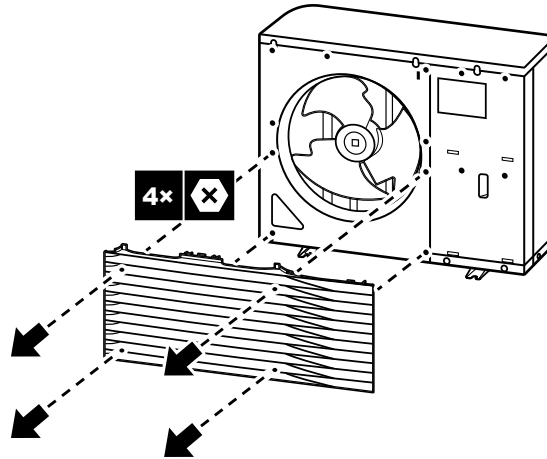

- 3 Rotate the lower part of the discharge grille.

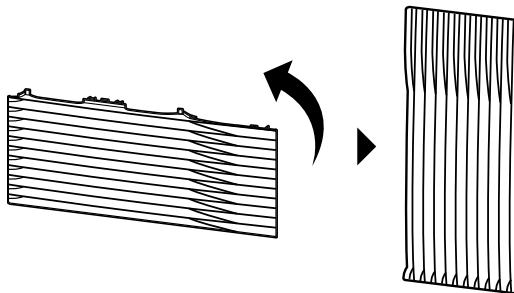

- 4 Align the ball stud and hook on the grille with their counterparts on the unit.

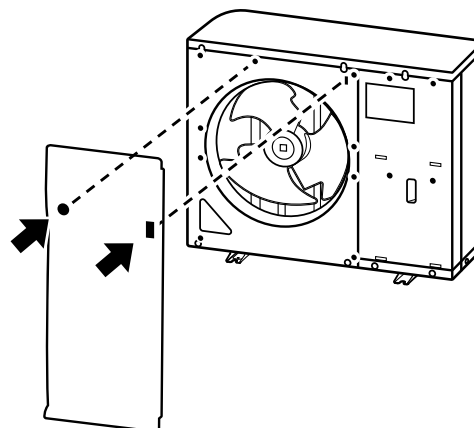

- 5 Insert the hook.
6 Insert the ball stud.

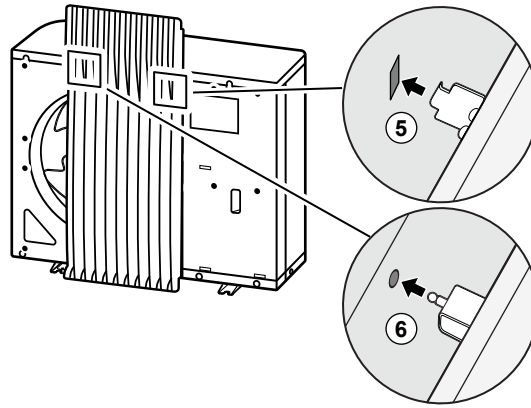

6.4 Mounting the indoor unit

6.4.1 About mounting the indoor unit

Typical workflow

Mounting the indoor unit typically consists of the following stages:

- 1 Installing the indoor unit.

6.4.2 Precautions when mounting the indoor unit



INFORMATION

Also read the precautions and requirements in the following chapters:

- "1 General safety precautions" [▶ 6]
- "6.1 Preparing the installation site" [▶ 54]

6.4.3 To install the indoor unit

- 1 Lift the indoor unit from the pallet and place it on the floor. Also see "[To handle the indoor unit](#)" [▶ 20].
- 2 Connect the drain hose to the drain. See "[To connect the drain hose to the drain](#)" [▶ 71].
- 3 Slide the indoor unit into position.
- 4 Adjust the height of the leveling feet to compensate for floor irregularities. The maximum allowed deviation is 1°.

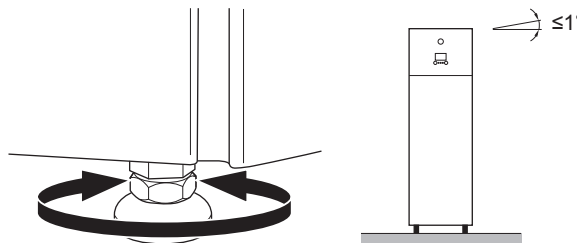

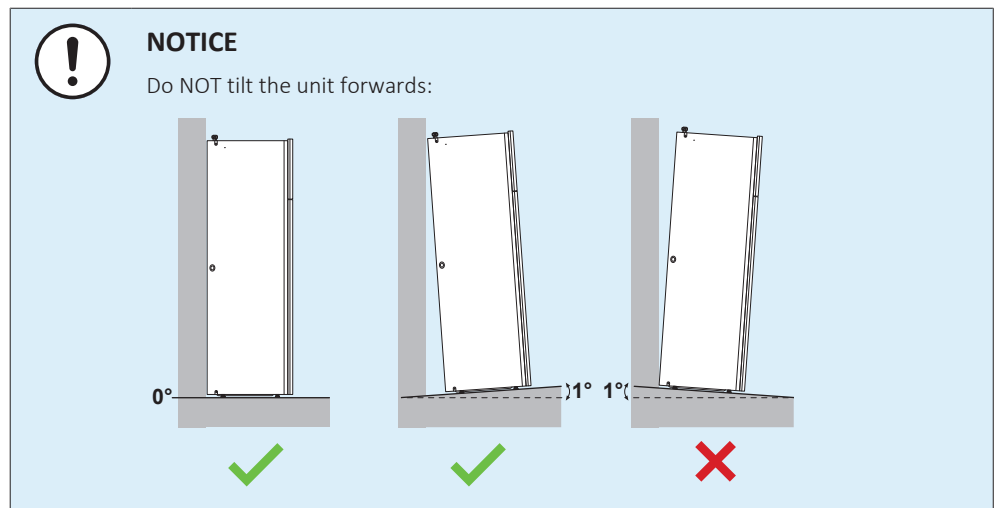

6.4.4 To connect the drain hose to the drain

Water coming from the pressure relief valve is collected in the drain pan. The drain pan is connected to a drain hose inside the unit. You must connect the drain hose to an appropriate drain according to the applicable legislation. You can route the drain hose through the left or right side panel.

Prerequisite: The user interface panel and front panel have been removed.

- 1 Remove one of the side panels.
- 2 Cut out the rubber grommet.
- 3 Pull the drain hose through the hole.
- 4 Reattach the side panel. Ensure the water can flow through the drain tube.

It is recommended to use a tundish to collect the water.

Option 1: Through the left side panel

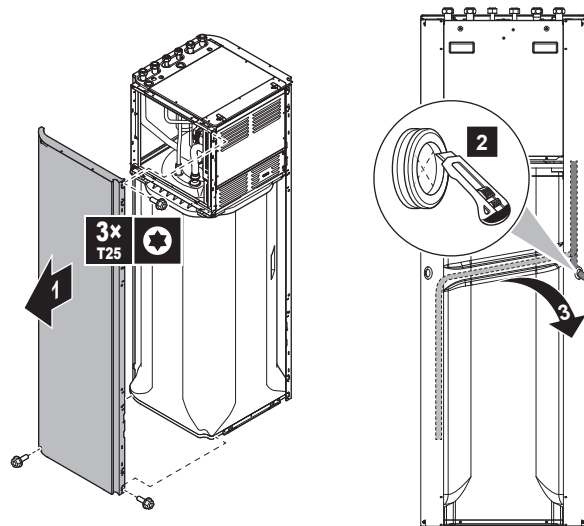

Option 2: Through the right side panel

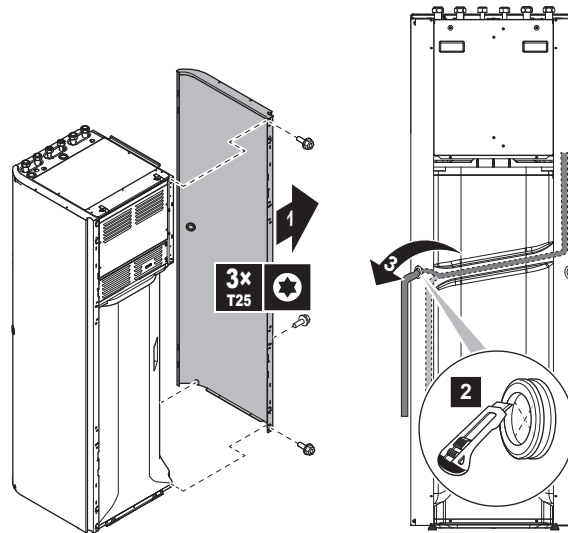

7 Piping installation

In this chapter

7.1	Preparing water piping	73
7.1.1	Water circuit requirements	73
7.1.2	Formula to calculate the expansion vessel pre-pressure	75
7.1.3	To check the water volume and flow rate	75
7.1.4	Changing the pre-pressure of the expansion vessel	78
7.1.5	To check the water volume: Examples	78
7.2	Connecting water piping	79
7.2.1	About connecting the water piping	79
7.2.2	Precautions when connecting the water piping	79
7.2.3	To connect the water piping	79
7.2.4	To connect the recirculation piping	82
7.2.5	To fill the water circuit	82
7.2.6	To protect the water circuit against freezing	82
7.2.7	To fill the domestic hot water tank	85
7.2.8	To insulate the water piping	86

7.1 Preparing water piping

7.1.1 Water circuit requirements



INFORMATION

Also read the precautions and requirements in the "[1 General safety precautions](#)" [6].



NOTICE

In case of plastic pipes, make sure they are fully oxygen diffusion tight according to DIN 4726. The diffusion of oxygen into the piping can lead to excessive corrosion.

- **Connecting piping – Legislation.** Make all piping connections in accordance with the applicable legislation and the instructions in the "Installation" chapter, respecting the water inlet and outlet.
- **Connecting piping – Force.** Do NOT use excessive force when connecting the piping. Deformation of the piping can cause malfunctioning of the unit.
- **Connecting piping – Tools.** Only use appropriate tooling to handle brass, which is a soft material. If NOT, pipes will get damaged.
- **Connecting piping – Air, moisture, dust.** If air, moisture or dust gets into the circuit, problems may occur. To prevent this:
 - Only use clean pipes
 - Hold the pipe end downwards when removing burrs.
 - Cover the pipe end when inserting it through a wall, to prevent dust and/or particles from entering the pipe.
 - Use a decent thread sealant to seal connections.
- **Insulation.** Insulate up to the base of the heat exchanger.
- **Freeze.** Protect against freezing.
- **Closed circuit.** Use the indoor unit ONLY in a closed water system. Using the system in an open water system will lead to excessive corrosion.

- **Piping length.** It is recommended to avoid long runs of piping between the domestic hot water tank and the hot water end point (shower, bath,...) and to avoid dead ends.
- **Piping diameter.** Select the water piping diameter in relation to the required water flow and the available external static pressure of the pump. See "[15 Technical data](#)" [▶ 232] for the external static pressure curves of the indoor unit.
- **Water flow.** You can find the minimum required water flow for indoor unit operation in the following table. In all cases, this flow needs to be guaranteed. When the flow is lower, the indoor unit will stop operation and display error 7H.

Minimum required flow rate
25 l/min

- **Field supply components – Water.** Only use materials that are compatible with water used in the system and with the materials used in the indoor unit.
- **Field supply components – Water pressure and temperature.** Check that all components in the field piping can withstand the water pressure and water temperature.
- **Water pressure.** The maximum water pressure is 4 bar. Provide adequate safeguards in the water circuit to ensure that the maximum pressure is NOT exceeded.
- **Water temperature.** All installed piping and piping accessories (valve, connections,...) MUST withstand the following temperatures:



INFORMATION

The following illustration is an example and might NOT match your system layout.

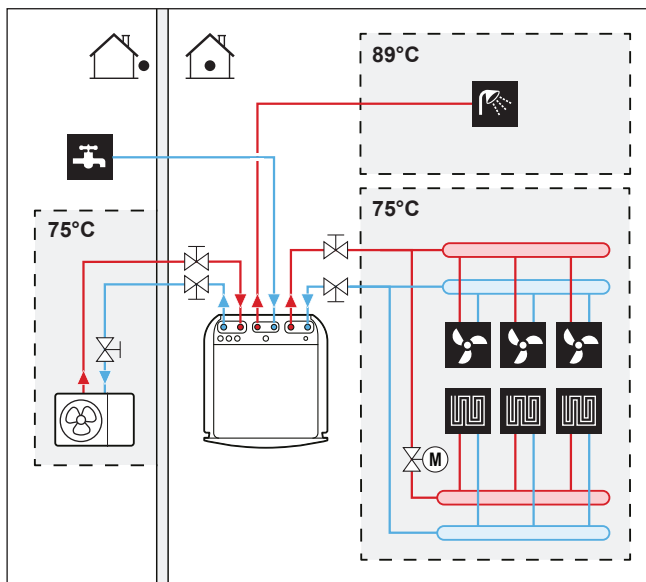

- **Drainage – Low points.** Provide drain taps at all low points of the system in order to allow complete drainage of the water circuit.
- **Drainage – Pressure relief valve.** Connect the drain hose properly to the drain to avoid water dripping out of the unit. See "[To connect the drain hose to the drain](#)" [▶ 71].

- **Air vents.** Provide air vents at all high points of the system, which must also be easily accessible for servicing. Two automatic air purges are provided in the indoor unit. Check that the air purges are NOT tightened too much, so that automatic release of air in the water circuit is possible.
- **Zn-coated parts.** Never use zinc coated parts in the water circuit. Because the internal water circuit of the unit uses copper piping, excessive corrosion may occur.
- **Non-brass metallic piping.** When using non-brass metallic piping, insulate the brass and non-brass properly so that they do NOT make contact with each other. This to prevent galvanic corrosion.
- **Valve – Change-over time.** When using a 2-way valve or a 3-way valve in the water circuit, the maximum change-over time of the valve must be 60 seconds.
- **Domestic hot water tank – Capacity.** To avoid stagnation of water, it is important that the storage capacity of the domestic hot water tank meets the daily consumption of domestic hot water.
- **Domestic hot water tank – After installation.** Immediately after installation, the domestic hot water tank must be flushed with fresh water. This procedure must be repeated at least once a day the first 5 consecutive days after installation.
- **Domestic hot water tank – Standstills.** In cases where during longer periods of time there is no consumption of hot water, the equipment MUST be flushed with fresh water before usage.
- **Domestic hot water tank – Disinfection.** For the disinfection function of the domestic hot water tank, see "Tank" [▶ 163].
- **Thermostatic mixing valves.** In accordance with the applicable legislation, it may be necessary to install thermostatic mixing valves.
- **Hygienic measures.** The installation must be in compliance with the applicable legislation and may require additional hygienic installation measures.
- **Recirculation pump.** In accordance with the applicable legislation, it may be required to connect a recirculation pump in between the hot water end point and the recirculation connection of the domestic hot water tank.

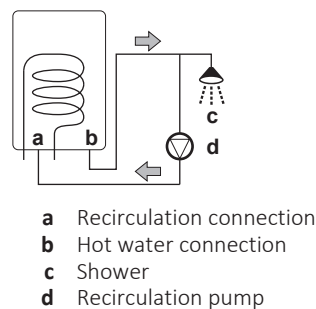

7.1.2 Formula to calculate the expansion vessel pre-pressure

The pre-pressure (P_g) of the vessel depends on the installation height difference (H):

$$P_g = 0.3 + (H/10) \text{ (bar)}$$

7.1.3 To check the water volume and flow rate

The indoor unit has an expansion vessel of 10 litre with a factory-set pre-pressure of 1 bar.

To make sure that the unit operates properly:

- You must check the minimum and maximum water volume.
- You might need to adjust the pre-pressure of the expansion vessel.

Minimum water volume

Check that the total water volume in the installation is minimum 20 litres, the internal water volume of the outdoor unit NOT included.

i **INFORMATION**
 In critical processes, or in rooms with a high heat load, extra water might be required.

! **NOTICE**
 When circulation in each space heating/cooling loop is controlled by remotely controlled valves, it is important that the minimum water volume is guaranteed, even if all of the valves are closed.

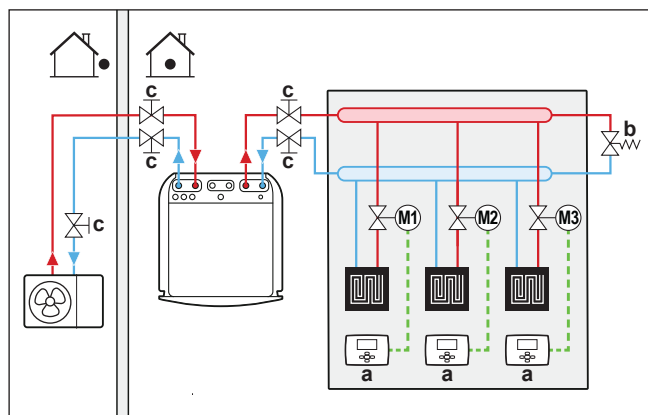

- a Individual room thermostat (optional)
- b Overpressure bypass valve (delivered as accessory)
- c Shut-off valve

Maximum water volume

! **NOTICE**
 The maximum water volume depends on whether glycol is added to the water circuit. For more information on the addition of glycol, refer to "To protect the water circuit against freezing" [▶ 82].

Use the following graph to determine the maximum water volume for the calculated pre-pressure.

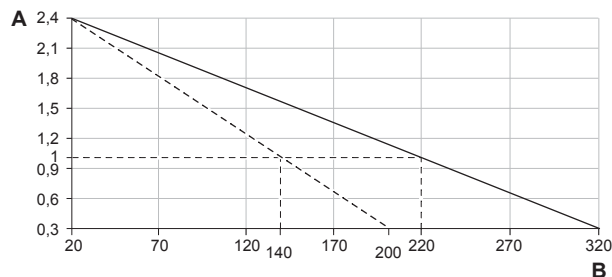

- A Pre-pressure (bar)
- B Maximum water volume (l)
- Water
- - - Water + glycol

Example: Maximum water volume and expansion vessel pre-pressure

Installation height difference ^(a)	Water volume	
	≤200 l	>200 l
≤7 m	No pre-pressure adjustment is required.	Do the following: <ul style="list-style-type: none"> Decrease the pre-pressure according to the required installation height difference. The pre-pressure should decrease by 0.1 bar for each metre below 7 m. Check if the water volume does NOT exceed the maximum allowed water volume.
>7 m	Do the following: <ul style="list-style-type: none"> Increase the pre-pressure according to the required installation height difference. The pre-pressure should increase by 0.1 bar for each metre above 7 m. Check if the water volume does NOT exceed the maximum allowed water volume. 	The expansion vessel of the indoor unit is too small for the installation. In this case, it is recommended to install an extra vessel outside the unit.

^(a) This is the height difference (m) between the highest point of the water circuit and the indoor unit. If the indoor unit is at the highest point of the installation, the installation height is 0 m.

Minimum flow rate

Check that the minimum flow rate in the installation is guaranteed in all conditions. This minimum flow rate is required during defrost/backup heater operation. For this purpose, use the overpressure bypass valve delivered with the unit, and respect the minimum water volume.

Minimum required flow rate

25 l/min



NOTICE

To guarantee proper operation it is recommended to have a minimum flow of 28 l/min during DHW.



NOTICE

If glycol was added to the water circuit, and the temperature of the water circuit is low, the flow rate will NOT be displayed on the user interface. In this case, the minimum flow rate can be checked by way of the pump test (check that the user interface does NOT display error 7H).

**NOTICE**

When circulation in each or certain space heating loops is controlled by remotely controlled valves, it is important that the minimum flow rate is guaranteed, even if all valves are closed. In case the minimum flow rate cannot be reached, a flow error 7H will be generated (no heating or operation).

See the recommended procedure as described in "10.4 Checklist during commissioning" [▶ 201].

7.1.4 Changing the pre-pressure of the expansion vessel

**NOTICE**

Only a licensed installer may adjust the pre-pressure of the expansion vessel.

The default pre-pressure of the expansion vessel is 1 bar. When it is required to change the pre-pressure, take following guidelines into account:

- Only use dry nitrogen to set the expansion vessel pre-pressure.
- Inappropriate setting of the expansion vessel pre-pressure will lead to malfunction of the system.

Changing the pre-pressure of the expansion vessel should be done by releasing or increasing nitrogen pressure through the Schrader valve of the expansion vessel.

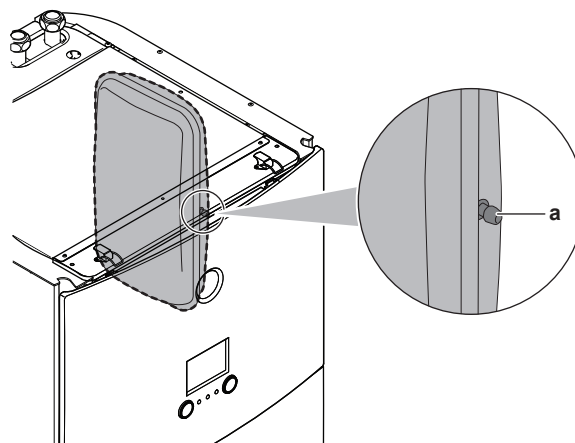

a Schrader valve

7.1.5 To check the water volume: Examples

Example 1

The indoor unit is installed 5 m below the highest point in the water circuit. The total water volume in the water circuit is 100 l.

No actions or adjustments are required.

Example 2

The indoor unit is installed at the highest point in the water circuit. The total water volume in the water circuit is 250 l.

Actions:

- Because the total water volume (250 l) is more than the default water volume (200 l), the pre-pressure must be decreased.
- The required pre-pressure is:

$$P_g = (0.3 + (H/10)) \text{ bar} = (0.3 + (0/10)) \text{ bar} = 0.3 \text{ bar}$$

- The corresponding maximum water volume at 0.3 bar is 290 l. (See the graph in "[Maximum water volume](#)" [[▶ 76](#)]).
- Because 250 l is lower than 290 l, the expansion vessel is appropriate for the installation.

7.2 Connecting water piping

7.2.1 About connecting the water piping

Before connecting the water piping

Make sure the outdoor and indoor unit are mounted.

Typical workflow

Connecting the water piping typically consists of the following stages:

- 1 Connecting the water piping to the outdoor unit.
- 2 Connecting the water piping to the indoor unit.
- 3 Connecting the recirculation piping.
- 4 Connecting the drain hose to the drain.
- 5 Filling the water circuit.
- 6 Filling the domestic hot water tank.
- 7 Insulating the water piping.

7.2.2 Precautions when connecting the water piping



INFORMATION

Also read the precautions and requirements in the following chapters:

- "[1 General safety precautions](#)" [[▶ 6](#)]
- "[7.1 Preparing water piping](#)" [[▶ 73](#)]

7.2.3 To connect the water piping



NOTICE

Do NOT use excessive force when connecting the field piping and make sure the piping is aligned properly. Deformation of the piping can cause malfunctioning of the unit.

Outdoor unit

- 1 Connect the shut-off valve (with integrated filter) to the outdoor unit water inlet, using thread sealant.

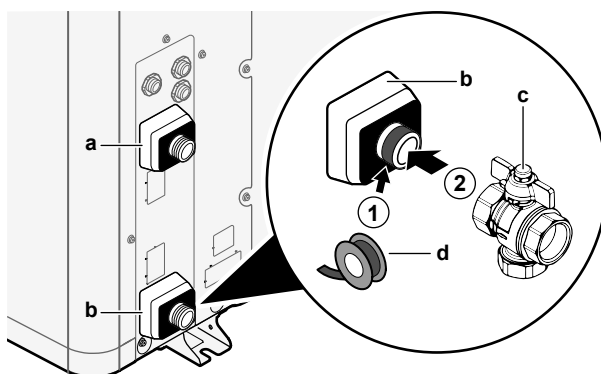

- a Water OUT (screw connection, male, 1")
- b Water IN (screw connection, male, 1")
- c Shut-off valve with integrated filter (delivered as accessory)(2x screw connection, female, 1")
- d Thread sealant

- 2 Connect the field piping to the shut-off valve.
- 3 Connect the field piping to the outdoor unit water outlet.



NOTICE

About the shut-off valve with integrated filter (delivered as accessory):

- The installation of the valve at the water inlet is mandatory.
- Mind the flow direction of the valve.



NOTICE

Install air purge valves at all local high points.

Indoor unit

- 1 Connect the O-rings and shut-off valves to the outdoor unit water connection pipes of the indoor unit.
- 2 Connect the outdoor unit field piping to the shut-off valves.
- 3 Connect the O-rings and shut-off valves to the space heating/cooling water pipes of the indoor unit.
- 4 Connect the space heating/cooling field piping of both zones to the shut-off valves.
- 5 Connect the domestic hot water in and out pipes to the indoor unit.

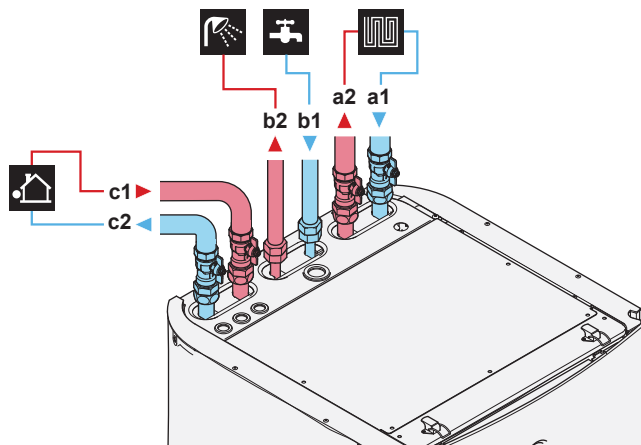

- a1 Space heating/cooling – Water IN (screw connection, 1")
- a2 Space heating/cooling – Water OUT (screw connection, 1")
- b1 DHW – Cold water IN (screw connection, 3/4")

- b2** DHW – Hot water OUT (screw connection, 3/4")
c1 Water IN from outdoor unit (screw connection, 1")
c2 Water OUT to outdoor unit (screw connection, 1")

**NOTICE**

It is recommended to install shut-off valves to domestic cold water in and domestic hot water out connections. These shut-off valves are field supplied.

**NOTICE**

To avoid damage to the surroundings in case of water leakage, it is recommended to close the domestic cold water inlet shut-off valves during periods of absence.

**NOTICE**

Overpressure bypass valve (delivered as accessory). We recommend to install the overpressure bypass valve in the space heating water circuit.

- Mind the minimum water volume when choosing the installation location of the overpressure bypass valve (at the indoor unit, or at the collector). See "[To check the water volume and flow rate](#)" [▶ 75].
- Mind the minimum flow rate when adjusting the overpressure bypass valve setting. See "[To check the water volume and flow rate](#)" [▶ 75] and "[Minimum flow rate](#)" [▶ 201].

**NOTICE**

Install air purge valves at all local high points.

**NOTICE**

A pressure relief valve (field supply) with an opening pressure of maximum 10 bar (=1 MPa) must be installed on the domestic cold water inlet connection in accordance with the applicable legislation.

**NOTICE**

- A drain device and pressure relief device must be installed on the cold water inlet connection of the domestic hot water cylinder.
- To avoid back siphonage, it is recommended to install a non-return valve on the water inlet of the domestic hot water tank in accordance with the applicable legislation.
- It is recommended to install a pressure reducing valve on the cold water inlet in accordance with the applicable legislation.
- An expansion vessel should be installed on the cold water inlet in accordance with the applicable legislation.
- It is recommended to install the pressure relief valve on a higher position than the top of the domestic hot water tank. Heating of the domestic hot water tank causes water to expand and without pressure relief valve the water pressure inside the tank can rise above the tank design pressure. Also the field installation (piping, tapping points, etc.) connected to the tank is subjected to this high pressure. To prevent this, a pressure relief valve needs to be installed. The overpressure prevention depends on the correct operation of the field installed pressure relief valve. If this is NOT working correctly, overpressure will deform the tank and water leakage may occur. To confirm good operation, regular maintenance is required.

7.2.4 To connect the recirculation piping

Prerequisite: Only required if you need recirculation in your system.

- 1 Remove the top panel from the unit, see "[To open the indoor unit](#)" [▶ 60].
- 2 Cut out the rubber grommet on top of the unit, and remove the stop. The recirculation connector is placed below the hole.
- 3 Route the recirculation piping through the grommet and connect it to the recirculation connector.

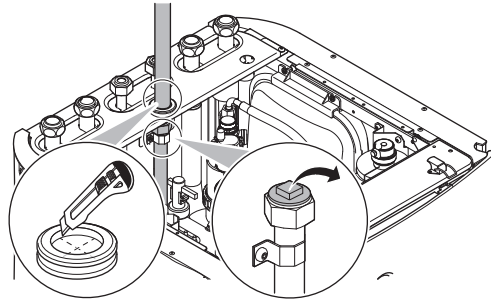



- 4 Reattach the top panel.

7.2.5 To fill the water circuit

To fill the water circuit, use a field supply filling kit. Make sure you comply with the applicable legislation.

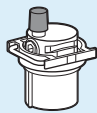
 **NOTICE**

Make sure both air purge valves (one on the magnetic filter and one on the backup heater) are open.

All automatic air purge valves must remain open after commissioning.

7.2.6 To protect the water circuit against freezing

About freeze protection

Frost can damage the system. To prevent the hydraulic components from freezing, the software is equipped with special frost protection functions, that include the activation of pump in case of low temperatures:

- Water pipe freeze prevention (see "[Water pipe freeze prevention](#)" [▶ 183]),
- Drain prevention. Only applicable when **Bivalent** is enabled ([C-02]=1). This function prevents the opening of freeze protection valves in the water piping to the outdoor unit when the auxiliary boiler is running at negative outdoor temperatures.

However, in case of a power failure, these functions cannot guarantee protection.

Do one of the following to protect the water circuit against freezing:

- Add glycol to the water. Glycol lowers the freezing point of the water.
- Install freeze protection valves. Freeze protection valves drain the water from the system before it can freeze.

**NOTICE**

If you add glycol to the water, do NOT install freeze protection valves. **Possible consequence:** Glycol leaking out of the freeze protection valves.

Freeze protection by glycol**About freeze protection by glycol**

Adding glycol to the water lowers the freezing point of water.

**WARNING**

Ethylene glycol is toxic.

**WARNING**

Due to the presence of glycol, corrosion of the system is possible. Uninhibited glycol will turn acidic under the influence of oxygen. This process is accelerated by the presence of copper and high temperatures. The acidic uninhibited glycol attacks metal surfaces and forms galvanic corrosion cells that cause severe damage to the system. Therefore it is important that:

- the water treatment is correctly executed by a qualified water specialist,
- a glycol with corrosion inhibitors is selected to counteract acids formed by the oxidation of glycols,
- no automotive glycol is used because their corrosion inhibitors have a limited lifetime and contain silicates which can foul or plug the system,
- galvanized pipes are NOT used in glycol systems since the presence may lead to the precipitation of certain components in the glycol's corrosion inhibitor.

**NOTICE**

Glycol absorbs water from its environment. Therefore do NOT add glycol that has been exposed to air. Leaving the cap off the glycol container causes the concentration of water to increase. The glycol concentration is then lower than assumed. As a result, the hydraulic components might freeze up after all. Take preventive actions to ensure a minimal exposure of the glycol to air.

Types of glycol

The types of glycol that can be used depend on whether the system contains a domestic hot water tank:

If...	Then...
The system contains a domestic hot water tank	Only use propylene glycol ^(a)
The system does NOT contain a domestic hot water tank	You can use either propylene glycol ^(a) or ethylene glycol

^(a) Propylene glycol, including the necessary inhibitors, classified as Category III according to EN1717.

Required concentration of glycol

The required concentration of glycol depends on the lowest expected outdoor temperature, and on whether you want to protect the system from bursting or from freezing. To prevent the system from freezing, more glycol is required.

Add glycol according to the table below.

Lowest expected outdoor temperature	Prevent from bursting	Prevent from freezing
-5°C	10%	15%
-10°C	15%	25%
-15°C	20%	35%
-20°C	25%	—
-25°C	30%	—
-30°C	35%	—



INFORMATION

- Protection against bursting: the glycol will prevent the piping from bursting, but NOT the liquid inside the piping from freezing.
- Protection against freezing: the glycol will prevent the liquid inside the piping from freezing.



NOTICE

- The required concentration might differ depending on the type of glycol. ALWAYS compare the requirements from the table above with the specifications provided by the glycol manufacturer. If necessary, meet the requirements set by the glycol manufacturer.
- The added concentration of glycol should NEVER exceed 35%.
- If the liquid in the system is frozen, the pump will NOT be able to start. Mind that if you only prevent the system from bursting, the liquid inside might still freeze.
- When water is at standstill inside the system, the system is very likely to freeze and get damaged.

Glycol and the maximum allowed water volume

Adding glycol to the water circuit reduces the maximum allowed water volume of the system. For more information, see "[Maximum water volume](#)" [▶ 76].

Glycol setting



NOTICE

If glycol is present in the system, setting [E-0D] must be set to 1. If the glycol setting is NOT set correctly, the liquid inside the piping can freeze.

Freeze protection by freeze protection valves

About freeze protection valves

It is the responsibility of the installer to protect the field piping against freezing. When no glycol is added to the water, you can use freeze protection valves at all lowest points of the field piping to drain the water from the system before it can freeze.

To install freeze protection valves

To protect the field piping against freezing, install the following parts:

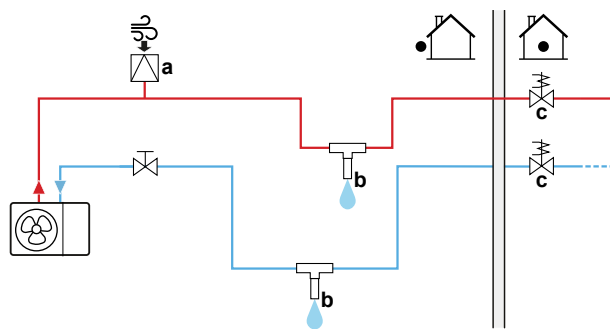

- a** Automatic air intake
b Freeze protection valve (optional – field supply)
c Normally closed valves (recommended – field supply)

Part	Description
	An automatic air intake (for air supply) should be installed at the highest point. For example, an automatic air purge.
	Protection for the field piping. The freeze protection valves must be installed: <ul style="list-style-type: none"> vertically to allow water to flow out properly and free from obstructions. at all lowest points of the field piping. in the coldest part and away from heat sources. Note: Leave at least 15 cm clearance from the ground to prevent ice from blocking the water exit.
	Isolation of water inside the house when there is a power interruption. Normally closed valves (located indoors near the piping entry/exit points) can prevent that all water from indoor piping is drained when the freeze protection valves open. <ul style="list-style-type: none"> When there is a power interruption: The normally closed valves close and isolate the water inside the house. If the freeze protection valves open, only the water outside the house is drained. In other circumstances (example: when there is a pump failure): The normally closed valves remain open. If the freeze protection valves open, the water from inside the house is also drained.



NOTICE

When freeze protection valves are installed, set the minimum cooling setpoint (default=7°C) at least 2°C higher than the maximum opening temperature of the freeze protection valve. If lower, freeze protection valves can open during cooling operation.

7.2.7 To fill the domestic hot water tank

- 1 Open every hot water tap in turn to purge air from the system pipe work.
- 2 Open the cold water supply valve.
- 3 Close all water taps after all air is purged.
- 4 Check for water leaks.

7.2.8 To insulate the water piping

The piping in the complete water circuit **MUST** be insulated to prevent condensation during cooling operation and reduction of the heating and cooling capacity.

Outdoor water piping insulation



NOTICE

Outside piping. Make sure the outside piping is insulated as instructed to protect against hazards.

For piping in free air, it is recommended to use the insulation thickness as shown in below table as a minimum (with $\lambda=0.039$ W/mK).

Piping length (m)	Minimum insulation thickness (mm)
<20	19
20~30	32
30~40	40
40~50	50

For other cases the minimum insulation thickness can be determined using the Hydronic Piping Calculation tool.

The Hydronic Piping Calculation tool also calculates the maximum hydronic piping length from the indoor unit to the outdoor unit based on the emitter pressure drop or the other way around.

The Hydronic Piping Calculation tool is part of the Heating Solutions Navigator which can be reached via <https://professional.standbyme.daikin.eu>.

Please contact your dealer if you have no access to Heating Solutions Navigator.

This recommendation ensures good operation of the unit, however, local regulations may differ and shall be followed.

8 Electrical installation

In this chapter

8.1	About connecting the electrical wiring	87
8.1.1	Precautions when connecting the electrical wiring	87
8.1.2	Guidelines when connecting the electrical wiring	88
8.1.3	About electrical compliance	89
8.1.4	About preferential kWh rate power supply.....	89
8.1.5	Overview of electrical connections except external actuators.....	90
8.2	Connections to the outdoor unit.....	91
8.2.1	To connect the electrical wiring to the outdoor unit	91
8.2.2	To reposition the air thermistor on the outdoor unit	97
8.3	Connections to the indoor unit	98
8.3.1	To connect the main power supply	101
8.3.2	To connect the backup heater power supply.....	103
8.3.3	To connect the shut-off valve	105
8.3.4	To connect the electricity meters.....	106
8.3.5	To connect the domestic hot water pump.....	107
8.3.6	To connect the alarm output.....	108
8.3.7	To connect the space cooling/heating ON/OFF output	109
8.3.8	To connect the changeover to external heat source	110
8.3.9	To connect the power consumption digital inputs	111
8.3.10	To connect the safety thermostat (normally closed contact).....	112
8.4	After connecting the electrical wiring to the indoor unit.....	113

8.1 About connecting the electrical wiring

Before connecting the electrical wiring

Make sure the water piping is connected.

Typical workflow

Connecting the electrical wiring typically consists of the following stages:

- "8.2 Connections to the outdoor unit" [▶ 91]
- "8.3 Connections to the indoor unit" [▶ 98]

8.1.1 Precautions when connecting the electrical wiring



DANGER: RISK OF ELECTROCUTION



WARNING

ALWAYS use multicore cable for power supply cables.



INFORMATION

Also read the precautions and requirements in the "1 General safety precautions" [▶ 6].

**WARNING**

- All wiring **MUST** be performed by an authorised electrician and **MUST** comply with the applicable legislation.
- Make electrical connections to the fixed wiring.
- All components procured on-site and all electrical construction **MUST** comply with the applicable legislation.

**WARNING**

- If the power supply has a missing or wrong N-phase, equipment might break down.
- Establish proper earthing. Do **NOT** earth the unit to a utility pipe, surge absorber, or telephone earth. Incomplete earthing may cause electrical shock.
- Install the required fuses or circuit breakers.
- Secure the electrical wiring with cable ties so that the cables do **NOT** come in contact with sharp edges or piping, particularly on the high-pressure side.
- Do **NOT** use taped wires, stranded conductor wires, extension cords, or connections from a star system. They can cause overheating, electrical shock or fire.
- Do **NOT** install a phase advancing capacitor, because this unit is equipped with an inverter. A phase advancing capacitor will reduce performance and may cause accidents.

**WARNING**

Rotating fan. Before powering ON or servicing the outdoor unit, make sure that the discharge grille covers the fan as protection against a rotating fan. See:

- ["To install the discharge grille" \[▶ 67\]](#)
- ["To remove the discharge grille, and put the grille in safety position" \[▶ 68\]](#)

**CAUTION**

Do **NOT** push or place redundant cable length in the unit.

**NOTICE**

The distance between the high voltage and low voltage cables should be at least 50 mm.

8.1.2 Guidelines when connecting the electrical wiring

Keep the following in mind:

- If stranded conductor wires are used, install a round crimp-style terminal on the end of the wire. Place the round crimp-style terminal on the wire up to the covered part and fasten the terminal with the appropriate tool.

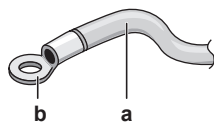

- a** Stranded conductor wire
- b** Round crimp-style terminal

- Use the following methods for installing wires:

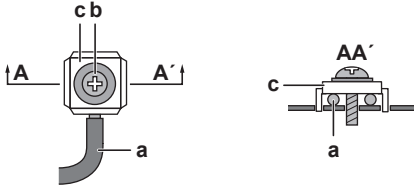
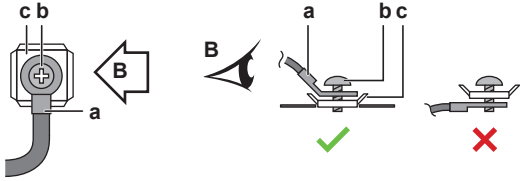
Wire type	Installation method
Single-core wire	 <p>a Curled single-core wire b Screw c Flat washer</p>
Stranded conductor wire with round crimp-style terminal	 <p>a Terminal b Screw c Flat washer ✓ Allowed ✗ NOT allowed</p>

Tightening torques

Outdoor unit:

Item	Tightening torque (N•m)
M4 (X1M, X2M)	1.2~1.5
M4 (earth)	

Indoor unit:

Item	Tightening torque (N•m)
M4 (X1M, X2M, X5M)	1.2~1.5
M4 (earth)	

8.1.3 About electrical compliance

Only for EPRA14~18DAV3

Equipment complying with EN/IEC 61000-3-12 (European/International Technical Standard setting the limits for harmonic currents produced by equipment connected to public low-voltage systems with input current >16 A and ≤75 A per phase.).

Only for the backup heater of the indoor unit

See "To connect the backup heater power supply" [▶ 103].

8.1.4 About preferential kWh rate power supply

Electricity companies throughout the world work hard to provide reliable electric service at competitive prices and are often authorized to bill clients at benefit rates. E.g. time-of-use rates, seasonal rates, Wärmepumpentarif in Germany and Austria, ...

This equipment allows for connection to such preferential kWh rate power supply delivery systems.

Consult with the electricity company acting as provider at the site where this equipment is to be installed to know whether it is appropriate to connect the equipment in one of the preferential kWh rate power supply delivery systems available, if any.

When the equipment is connected to such preferential kWh rate power supply, the electricity company is allowed to:

- interrupt power supply to the equipment for certain periods of time;
- demand that the equipment only consumes a limited amount of electricity during certain periods of time.

The indoor unit is designed to receive an input signal by which the unit switches into forced off mode. At that moment, the outdoor unit compressor will not operate.

The wiring to the unit is different depending on whether the power supply is interrupted or not.

8.1.5 Overview of electrical connections except external actuators

Normal power supply	Preferential kWh rate power supply	
	Power supply is NOT interrupted	Power supply is interrupted
<p style="text-align: center;">a</p>	<p style="text-align: center;">b</p> <p>During preferential kWh rate power supply activation, power supply is NOT interrupted. The outdoor unit is turned off by the control.</p> <p>Remark: The electricity company must always allow the power consumption of the indoor unit.</p>	<p style="text-align: center;">a</p>
		<p style="text-align: center;">b</p> <p>During preferential kWh rate power supply activation, power supply is interrupted immediately or after some time by the electricity company. In this case, the indoor unit must be powered by a separate normal power supply.</p>

- a Normal power supply
- b Preferential kWh rate power supply
- 1 Power supply for outdoor unit
- 2 Power supply and interconnection cable to indoor unit
- 3 Power supply for backup heater

- 4 Preferential kWh rate power supply (voltage free contact)
- 5 Normal kWh rate power supply (to power the indoor unit PCB in the event of power supply interruption of the preferential kWh rate power supply)

8.2 Connections to the outdoor unit

Item	Description
Power supply cable	See "To connect the electrical wiring to the outdoor unit" [▶ 91].
Interconnection cable	
Drain tube heater cable	
Connection for power saving function (only for V3 models)	
Air thermistor cable	See "To reposition the air thermistor on the outdoor unit" [▶ 97].

8.2.1 To connect the electrical wiring to the outdoor unit

- 1 Open the switch box cover. See "To open the outdoor unit" [▶ 58].
- 2 Strip insulation (20 mm) from the wires.

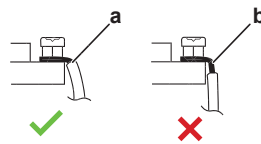

- a Strip wire end to this point
- b An excessive strip length may cause electrical shock or leakage

- 3 Insert the cables at the back of the unit, and route them through the factory-mounted cable sleeves into the switch box.

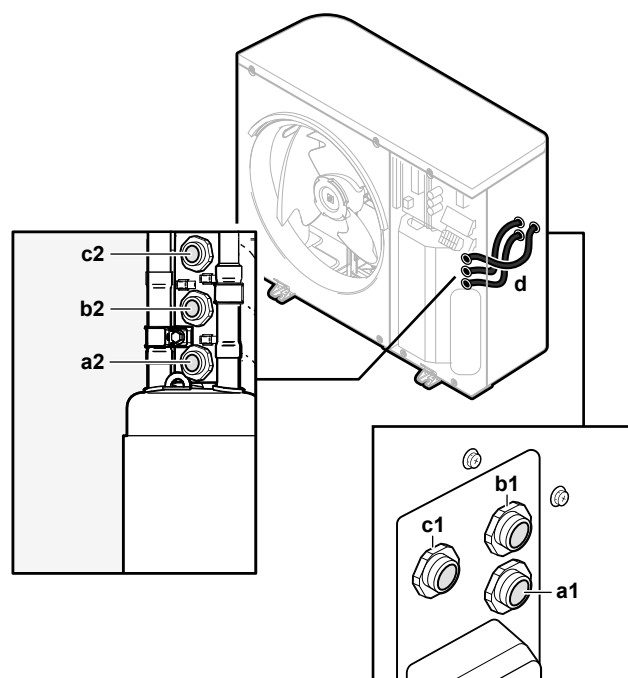

- a1+a2** Power supply cable (field supply)
- b1+b2** Interconnection cable (field supply)
- c1+c2** (optional) Drain tube heater cable (field supply)
- d** Cable sleeves (factory-mounted)



4 Inside the switch box, connect the wires to the appropriate terminals, and fix the cables with cable ties. See:

- "In case of V3 models" [▶ 92]
- "In case of W1 models" [▶ 94]

In case of V3 models

1 Power supply cable:

- Route the cable through the frame.
- Connect the wires to the terminal block.
- Fix the cable with a cable tie.

	Wires: 1N+GND Maximum running current: Refer to name plate on unit.
	—

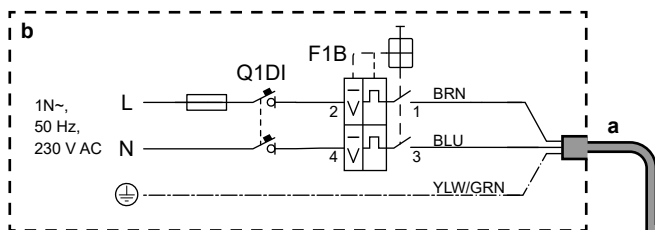
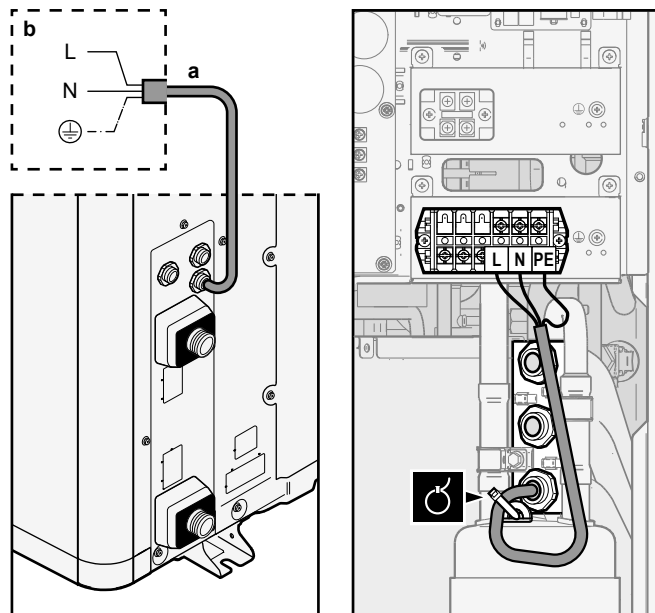

- a** Power supply cable (field supply)
- b** Field wiring
- F1B** Overcurrent fuse (field supply). Recommended fuse: 2 pole, 32 A fuse, C curve.
- Q1DI** Earth leakage circuit breaker (30 mA)(field supply)

2 Interconnection cable (indoor↔outdoor):

- Route the cable through the frame.
- Connect the wires to the terminal block (make sure the numbers match with the numbers on the indoor unit) and the earth screw.
- Fix the cable with a cable tie.

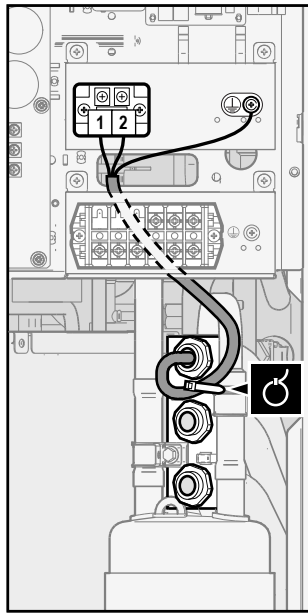

4 (Optional) Power saving function: If you want to use the power saving function:

- Disconnect X804A from X805A.
- Connect X804A to X806A.

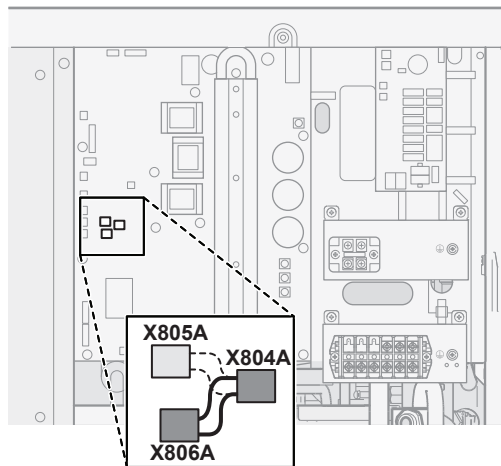

INFORMATION

Power saving function. The power saving function is only applicable for V3 models. For more information about the power saving function ([9.F] or overview field setting [E-08]), see "Power saving function" ▶ 192].

In case of W1 models

1 Power supply cable:

- Route the cable through the frame.
- Connect the wires to the terminal block.
- Fix the cable with a cable tie.

	Wires: 3N+GND Maximum running current: Refer to name plate on unit.
	—

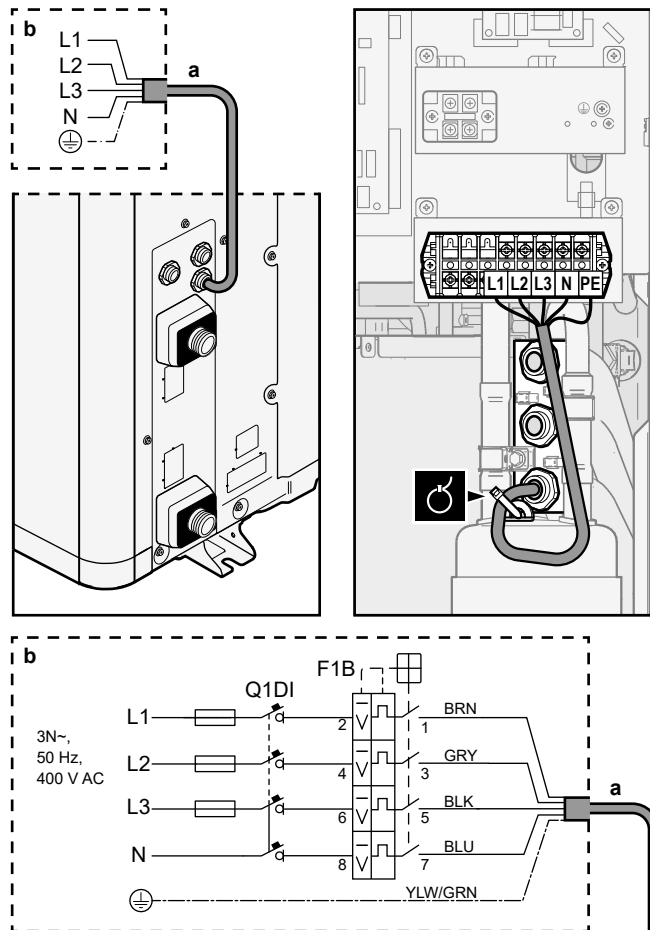

a Power supply cable (field supply)



b Field wiring

F1B Overcurrent fuse (field supply). Recommended fuse: 4 pole, 16 A or 20 A fuse, C curve.

Q1DI Earth leakage circuit breaker (30 mA)(field supply)

2 Interconnection cable (indoor↔outdoor):

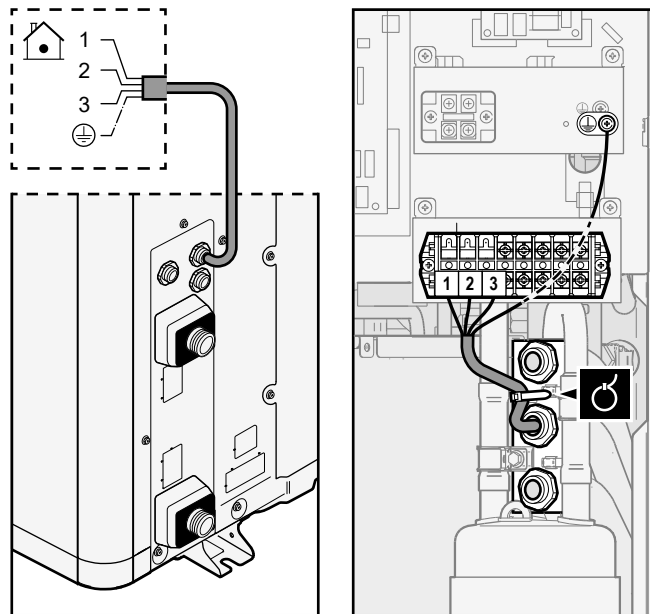

- Route the cable through the frame.
- Connect the wires to the terminal block (make sure the numbers match with the numbers on the indoor unit) and the earth screw.
- Fix the cable with a cable tie.

	Wires: (3+GND)×1.5 mm ²
	—



3 (Optional) Drain tube heater cable:

- Make sure the heating element of the drain tube heater is completely inside the drain tube.
- Route the cable through the frame.
- Connect the wires to the terminal block and the earth screw.
- Fix the cable with cable ties.

	Wires: (2+GND)×0.75 mm ² . Wiring must be double insulated. Maximum power allowed for drain tube heater = 115 W (0.5 A)
	—

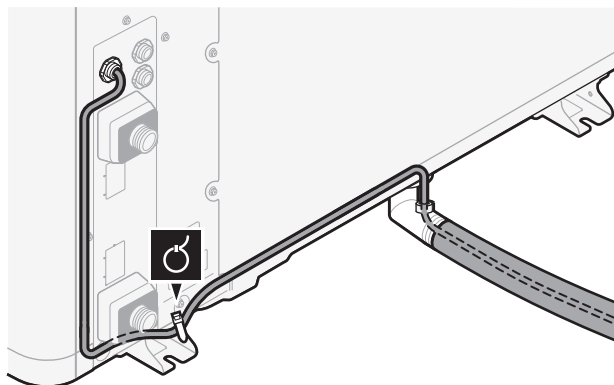

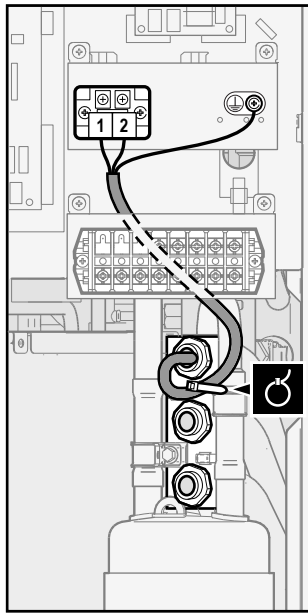

8.2.2 To reposition the air thermistor on the outdoor unit



This procedure is only necessary in areas with low ambient temperatures.



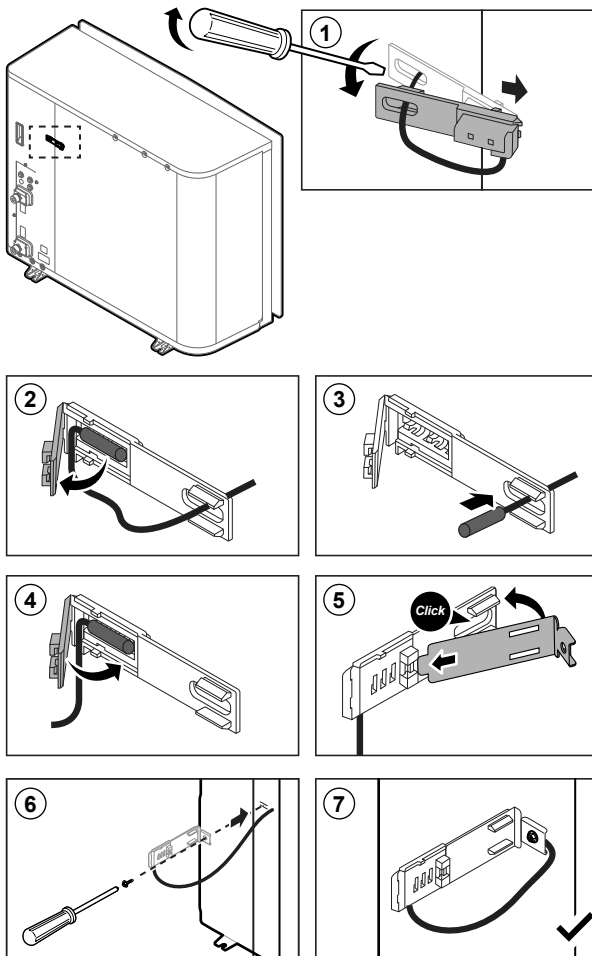





Required accessory (delivered with the unit):









	Thermistor fixture.
--	---------------------



8.3 Connections to the indoor unit

Item	Description
Power supply (main)	See "To connect the main power supply" [▶ 101].
Power supply (backup heater)	See "To connect the backup heater power supply" [▶ 103].
Shut-off valve	See "To connect the shut-off valve" [▶ 105].
Electricity meters	See "To connect the electricity meters" [▶ 106].
Domestic hot water pump	See "To connect the domestic hot water pump" [▶ 107].
Alarm output	See "To connect the alarm output" [▶ 108].
Space cooling/heating operation control	See "To connect the space cooling/heating ON/OFF output" [▶ 109].
Changeover to external heat source control	See "To connect the changeover to external heat source" [▶ 110].
Power consumption digital inputs	See "To connect the power consumption digital inputs" [▶ 111].
Safety thermostat	See "To connect the safety thermostat (normally closed contact)" [▶ 112].
Room thermostat (wired or wireless)	 See: <ul style="list-style-type: none"> Installation manual of the wireless room thermostat Installation manual of the wired room thermostat (digital or analogue) + multi-zoning base unit <ul style="list-style-type: none"> - Connection of the wired room thermostat (digital or analogue) to the multi-zoning base unit - Connection of the multi-zoning base unit to the indoor unit - For cooling/heating operation, you also need option EKRELAY1 Addendum book for optional equipment
	 Wires: 0.75 mm ² Maximum running current: 100 mA
	 For the main zone: <ul style="list-style-type: none"> [2.9] Control [2.A] Thermostat type For the additional zone: <ul style="list-style-type: none"> [3.A] Thermostat type [3.9] (read-only) Control

Item	Description	
Heat pump convector		<p>There are different controllers and setups possible for the heat pump convectors. Depending on the setup, you also need option EKRELAY1.</p> <p>For more information, see:</p> <ul style="list-style-type: none"> ▪ Installation manual of the heat pump convectors ▪ Installation manual of the heat pump convector options ▪ Addendum book for optional equipment
		<p>Wires: 0.75 mm² Maximum running current: 100 mA</p>
		<p>For the main zone:</p> <ul style="list-style-type: none"> ▪ [2.9] Control ▪ [2.A] Thermostat type <p>For the additional zone:</p> <ul style="list-style-type: none"> ▪ [3.A] Thermostat type ▪ [3.9] (read-only) Control
Remote outdoor sensor		<p>See:</p> <ul style="list-style-type: none"> ▪ Installation manual of the remote outdoor sensor ▪ Addendum book for optional equipment
		<p>Wires: 2×0.75 mm²</p>
		<p>[9.B.1]=1 (External sensor = Outdoor) [9.B.2] Ext. amb. sensor offset [9.B.3] Averaging time</p>
Remote indoor sensor		<p>See:</p> <ul style="list-style-type: none"> ▪ Installation manual of the remote indoor sensor ▪ Addendum book for optional equipment
		<p>Wires: 2×0.75 mm²</p>
		<p>[9.B.1]=2 (External sensor = Room) [1.7] Room sensor offset</p>

Item	Description	
Human Comfort Interface		See: <ul style="list-style-type: none"> Installation and operation manual of the Human Comfort Interface Addendum book for optional equipment
		Wires: 2×(0.75~1.25 mm ²) Maximum length: 500 m
		[2.9] Control [1.6] Room sensor offset
WLAN adapter		See: <ul style="list-style-type: none"> Installation manual of the WLAN adapter Addendum book for optional equipment
		Use the cable delivered with the WLAN adapter.
		[D] Wireless gateway
LAN adapter		See: <ul style="list-style-type: none"> Installation manual of the LAN adapter Addendum book for optional equipment
		Wires: 2×(0.75~1.25 mm ²). Must be sheathed. Maximum length: 200 m
		See below ("LAN adapter – System requirements").

LAN adapter – System requirements

The requirements posed on the system depend on the LAN adapter application/system layout (app control, or Smart Grid application).

App control:

Item	Requirement
LAN adapter software	It is recommended to ALWAYS keep the LAN adapter software up-to-date.
Unit control method	On the user interface, make sure to set [2.9]=2 (Control = Room thermostat)

Smart Grid application:

Item	Requirement
LAN adapter software	It is recommended to ALWAYS keep the LAN adapter software up-to-date.
Unit control method	On the user interface, make sure to set [2.9]=2 (Control = Room thermostat)
Domestic hot water settings	To allow for energy buffering in the domestic hot water tank, on the user interface, make sure to set [9.2.1]=4 (Domestic hot water = Integrated).

Item	Requirement
Power consumption control settings	On the user interface, make sure to set: <ul style="list-style-type: none"> ▪ [9.9.1]=1 (Power consumption control = Continuous) ▪ [9.9.2]=1 (Type = kW)

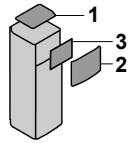

8.3.1 To connect the main power supply

1 Open the following (see "To open the indoor unit" [▶ 60]):

1	Top panel	
2	User interface panel	
3	Upper switch box cover	

2 Connect the main power supply.

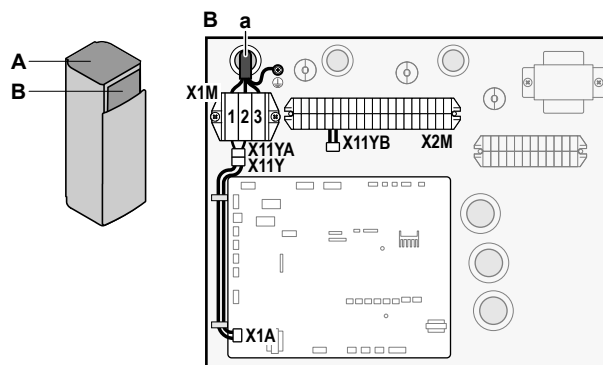
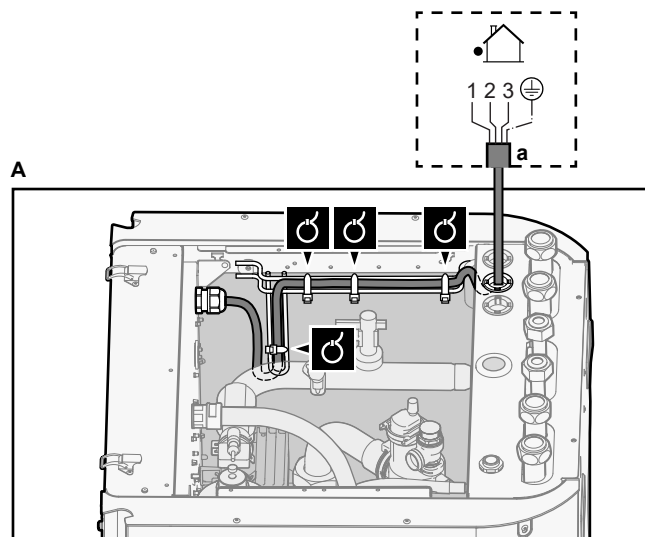

In case of normal kWh rate power supply

 Interconnection cable (= main power supply)	Wires: (3+GND)×1.5 mm ²
 —	



a Interconnection cable (=main power supply)

In case of preferential kWh rate power supply

	Interconnection cable (= main power supply)	Wires: (3+GND)×1.5 mm ²
	Normal kWh rate power supply	Wires: 1N Maximum running current: 6.3 A
	Preferential kWh rate power supply contact	Wires: 2×(0.75~1.25 mm ²) Maximum length: 50 m. Preferential kWh rate power supply contact: 16 V DC detection (voltage supplied by PCB). The voltage-free contact shall ensure the minimum applicable load of 15 V DC, 10 mA.
	[9.8] Benefit kWh power supply	

Connect X11Y to X11YB.

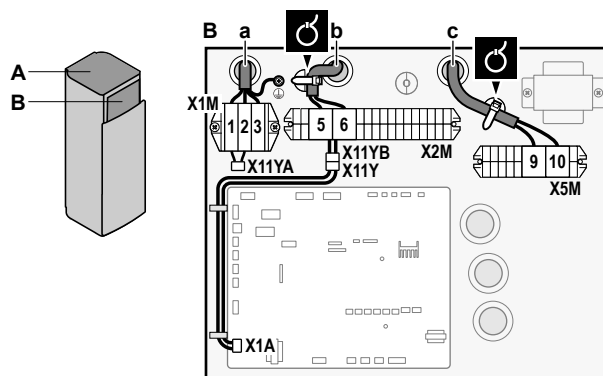
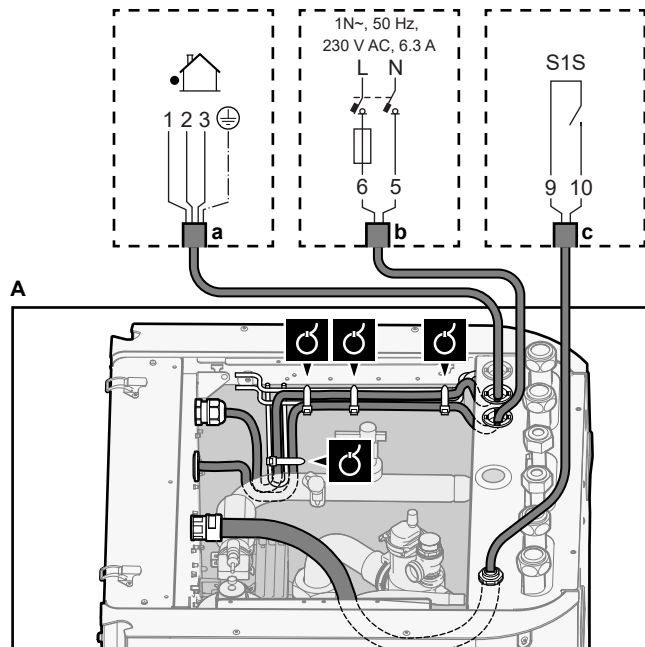

- a Interconnection cable (=main power supply)
- b Normal kWh rate power supply
- c Preferential power supply contact

3 Fix the cables with cable ties to the cable tie mountings.

**INFORMATION**

In case of preferential kWh rate power supply, connect X11Y to X11YB. The necessity of separate normal kWh rate power supply to indoor unit (b) X2M/5+6 depends on the type of preferential kWh rate power supply.



Separate connection to the indoor unit is required:

- if preferential kWh rate power supply is interrupted when active, OR
- if no power consumption of the indoor unit is allowed at the preferential kWh rate power supply when active.

**INFORMATION**

The preferential kWh rate power supply contact is connected to the same terminals (X5M/9+10) as the safety thermostat. Thus, the system can have EITHER preferential kWh rate power supply OR a safety thermostat.

8.3.2 To connect the backup heater power supply

	Backup heater type	Power supply	Wires
	*6V	1N~ 230 V (6V)	2+GND
		3~ 230 V (6T1)	3+GND
	*9W	3N~ 400 V	4+GND
	[9.3] Backup heater		

**WARNING**

The backup heater MUST have a dedicated power supply and MUST be protected by the safety devices required by the applicable legislation.

**CAUTION**

To guarantee the unit is completely earthed, always connect the backup heater power supply and the earth cable.

The backup heater capacity can vary, depending on the indoor unit model. Make sure that the power supply is in accordance with the backup heater capacity, as listed in the table below.

Backup heater type	Backup heater capacity	Power supply	Maximum running current	Z _{max}
*6V	2 kW	1N~ 230 V ^(a)	9 A	—
	4 kW	1N~ 230 V ^(a)	17 A ^{(b)(c)}	0.22 Ω
	6 kW	1N~ 230 V ^(a)	26 A ^{(b)(c)}	0.22 Ω
	2 kW	3~ 230 V ^(d)	5 A	—
	4 kW	3~ 230 V ^(d)	10 A	—
	6 kW	3~ 230 V ^(d)	15 A	—
*9W	3 kW	3N~ 400 V	4 A	—
	6 kW	3N~ 400 V	9 A	—
	9 kW	3N~ 400 V	13 A	—

- (a) 6V
- (b) Electrical equipment complying with EN/IEC 61000-3-12 (European/International Technical Standard setting the limits for harmonic currents produced by equipment connected to public low-voltage systems with input current >16 A and ≤75 A per phase).
- (c) This equipment complies with EN/IEC 61000-3-11 (European/International Technical Standard setting the limits for voltage changes, voltage fluctuations and flicker in public low-voltage supply systems for equipment with rated current ≤75 A) provided that the system impedance Z_{sys} is less than or equal to Z_{max} at the interface point between the user's supply and the public system. It is the responsibility of the installer or user of the equipment to ensure, by consultation with the distribution network operator if necessary, that the equipment is connected only to a supply with a system impedance Z_{sys} less than or equal to Z_{max} .
- (d) 6T1

Connect the backup heater power supply as follows:

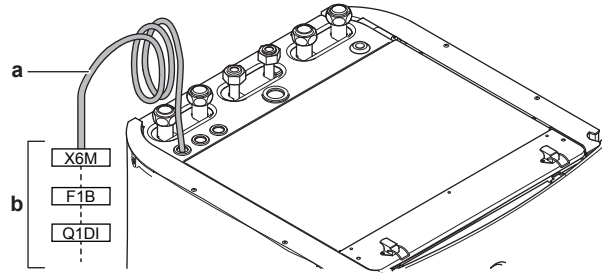

- a Factory-mounted cable connected to the contactor of the backup heater, inside the switch box (K5M)
- b Field wiring (see table below)

Model (power supply)	Connections to backup heater power supply
*6V (6V: 1N~ 230 V)	

Model (power supply)	Connections to backup heater power supply
*6V (6T1: 3~ 230 V)	
*9W (3N~ 400 V)	

F1B Overcurrent fuse (field supply). Recommended fuse: 4-pole; 20 A; curve 400 V; tripping class C.

K5M Safety contactor (in the lower switch box)

Q1DI Earth leakage circuit breaker (field supply)

SWB Switch box

X6M Terminal (field supply)



NOTICE



Do NOT cut or remove the backup heater power supply cable.

8.3.3 To connect the shut-off valve



INFORMATION

Shut-off valve usage example. In case of one LWT zone, and a combination of underfloor heating and heat pump convectors, install a shut-off valve before the underfloor heating to prevent condensation on the floor during cooling operation. For more information, see the installer reference guide.

	Wires: 2×0.75 mm ² Maximum running current: 100 mA 230 V AC supplied by PCB
	[2.D] Shut off valve

1 Open the following (see "To open the indoor unit" [▶ 60]):

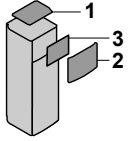
1	Top panel	
2	User interface panel	
3	Upper switch box cover	

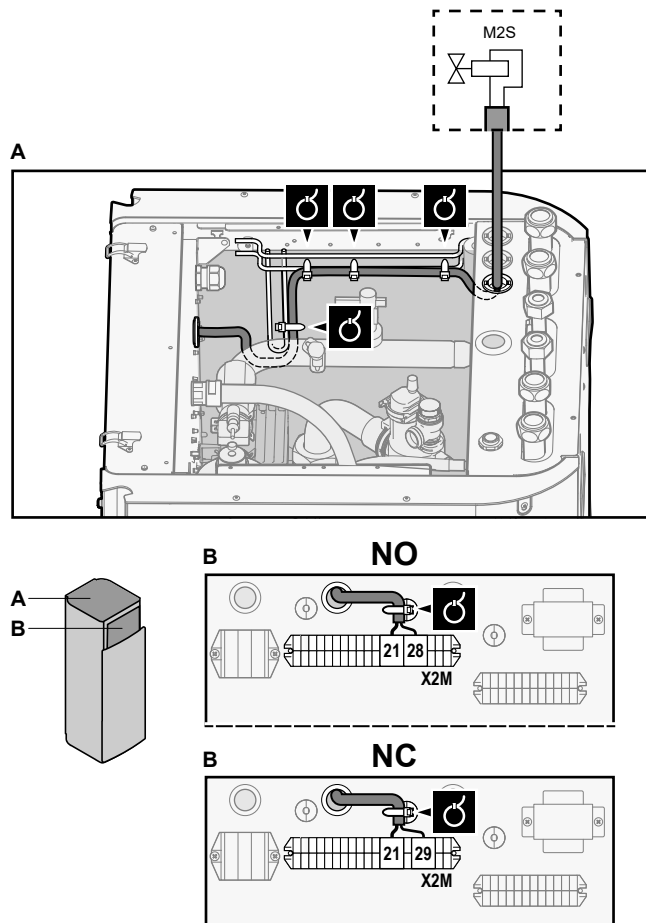

2 Connect the valve control cable to the appropriate terminals as shown in the illustration below.

 **NOTICE**
 Wiring is different for a NC (normally closed) valve and a NO (normally open) valve.



3 Fix the cable with cable ties to the cable tie mountings.

8.3.4 To connect the electricity meters

	Wires: 2 (per meter)×0.75 mm ² Electricity meters: 12 V DC pulse detection (voltage supplied by PCB)
	[9.A] Energy metering

**INFORMATION**

In case of an electricity meter with transistor output, check the polarity. The positive polarity **MUST** be connected to X5M/6 and X5M/4; the negative polarity to X5M/5 and X5M/3.

- 1 Open the following (see "To open the indoor unit" [▶ 60]):

1	Top panel	
2	User interface panel	
3	Upper switch box cover	

- 2 Connect the electricity meters cable to the appropriate terminals as shown in the illustration below.

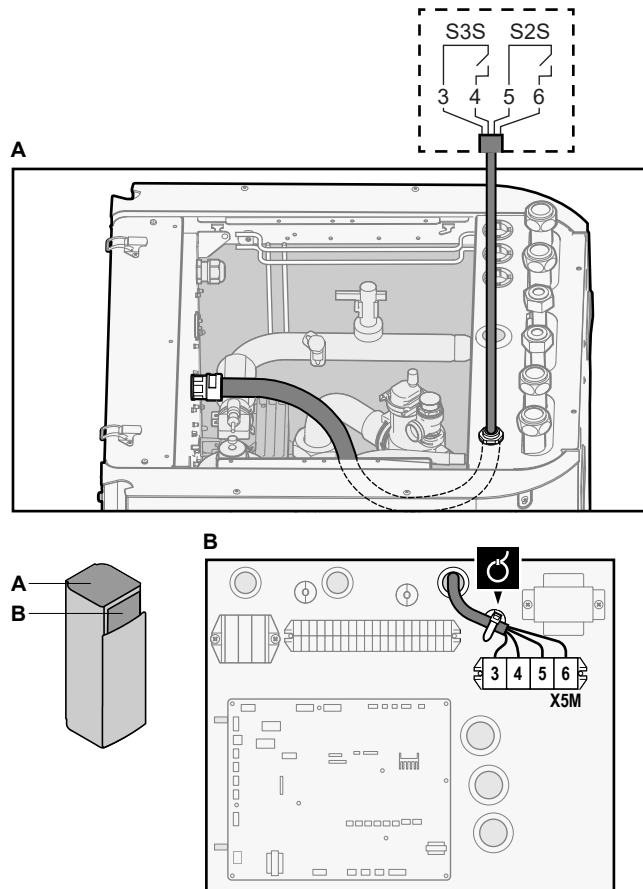

- 3 Fix the cable with cable ties to the cable tie mountings.

8.3.5 To connect the domestic hot water pump

	<p>Wires: (2+GND)×0.75 mm²</p> <p>DHW pump output. Maximum load: 2 A (inrush), 230 V AC, 1 A (continuous)</p>
	<p>[9.2.2] DHW pump</p> <p>[9.2.3] DHW pump schedule</p>

- 1 Open the following (see "To open the indoor unit" [▶ 60]):

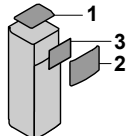

1	Top panel	
2	User interface panel	
3	Upper switch box cover	

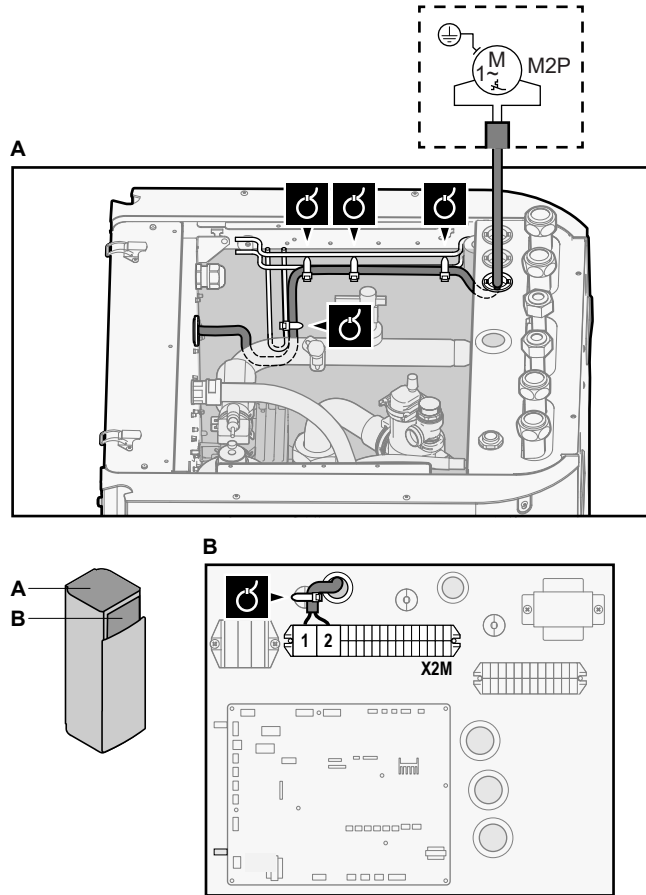
- 2 Connect the domestic hot water pump cable to the appropriate terminals as shown in the illustration below.



- 3 Fix the cable with cable ties to the cable tie mountings.

8.3.6 To connect the alarm output

	Wires: (2+1)×0.75 mm ² Maximum load: 0.3 A, 250 V AC
	[9.D] Alarm output

- 1 Open the following (see "To open the indoor unit" [▶ 60]):

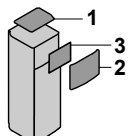
1	Top panel	
2	User interface panel	
3	Upper switch box cover	

- 2 Connect the alarm output cable to the appropriate terminals as shown in the illustration below.

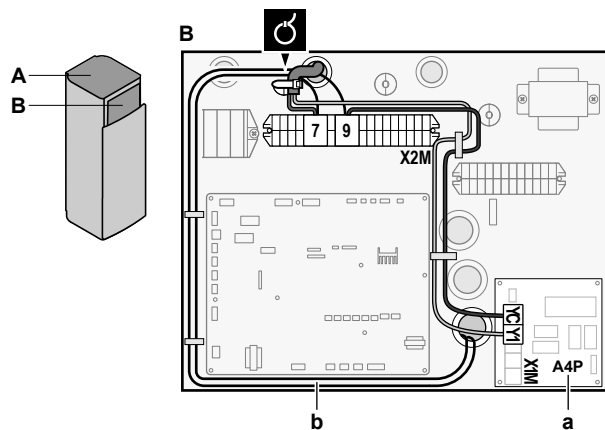
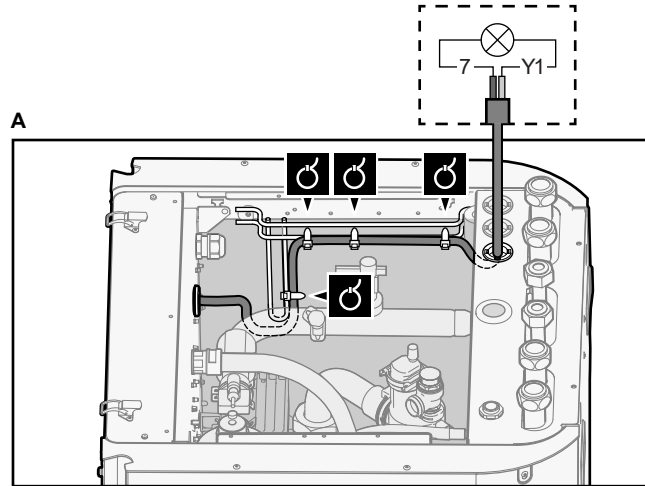
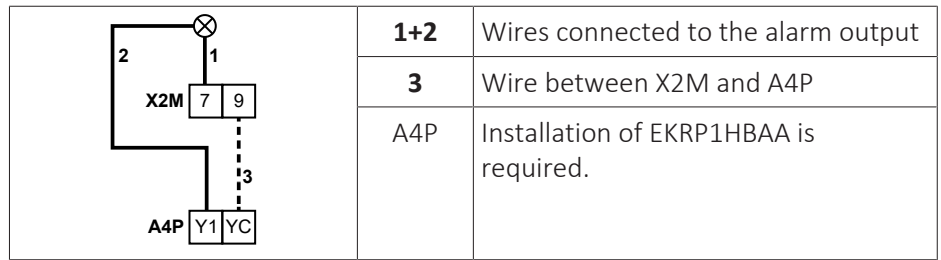

- a Installation of EKR1HBAA is required.
- b Prewiring between X2M/7+9 and Q1L (= thermal protector backup heater). Do NOT change.

3 Fix the cable with cable ties to the cable tie mountings.

8.3.7 To connect the space cooling/heating ON/OFF output

	<p>INFORMATION</p> <p>Cooling is only applicable in case of:</p> <ul style="list-style-type: none"> ▪ Reversible models ▪ Heating only models + conversion kit (EKHVCONV2)
--	---

	<p>Wires: (2+1)×0.75 mm²</p> <p>Maximum load: 0.3 A, 250 V AC</p>
	—

1 Open the following (see "To open the indoor unit" [▶ 60]):

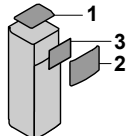
1	Top panel	
2	User interface panel	
3	Upper switch box cover	

2 Connect the space cooling/heating ON/OFF output cable to the appropriate terminals as shown in the illustration below.

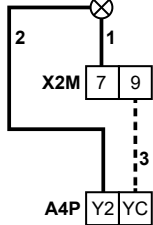

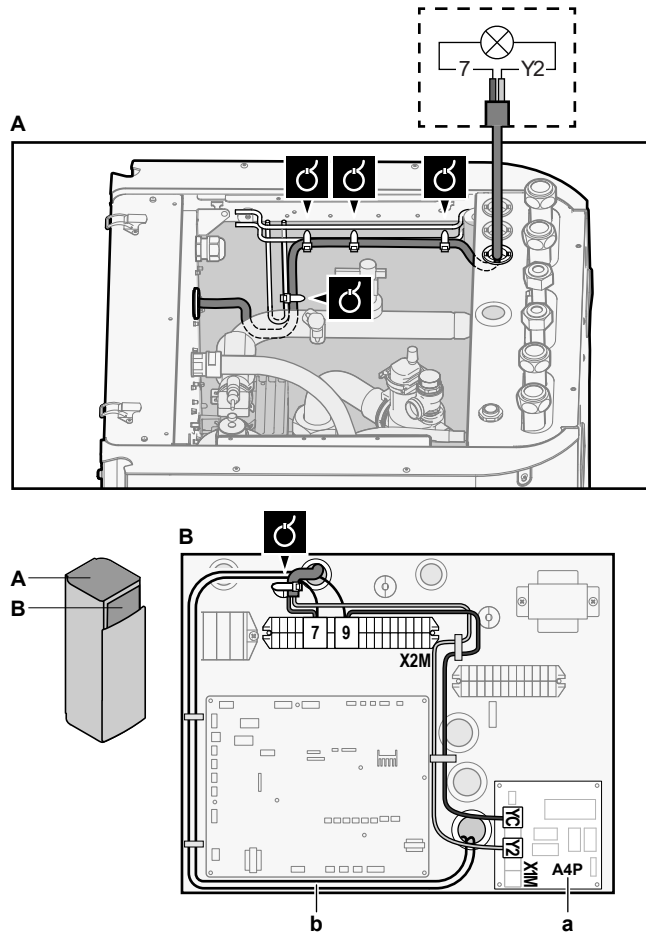
	1+2	Wires connected to the space cooling/heating ON/OFF output
	3	Wire between X2M and A4P
	A4P	Installation of EKR1HBAA is required.



- a** Installation of EKR1HBAA is required.
- b** Rewiring between X2M/7+9 and Q1L (= thermal protector backup heater). Do NOT change.

3 Fix the cable with cable ties to the cable tie mountings.

8.3.8 To connect the changeover to external heat source

	Wires: 2x0.75 mm ² Maximum load: 0.3 A, 250 V AC Minimum load: 20 mA, 5 V DC
	[9.C] Bivalent

1 Open the following (see "To open the indoor unit" [▶ 60]):

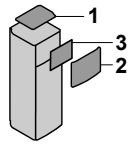
1	Top panel	
2	User interface panel	
3	Upper switch box cover	

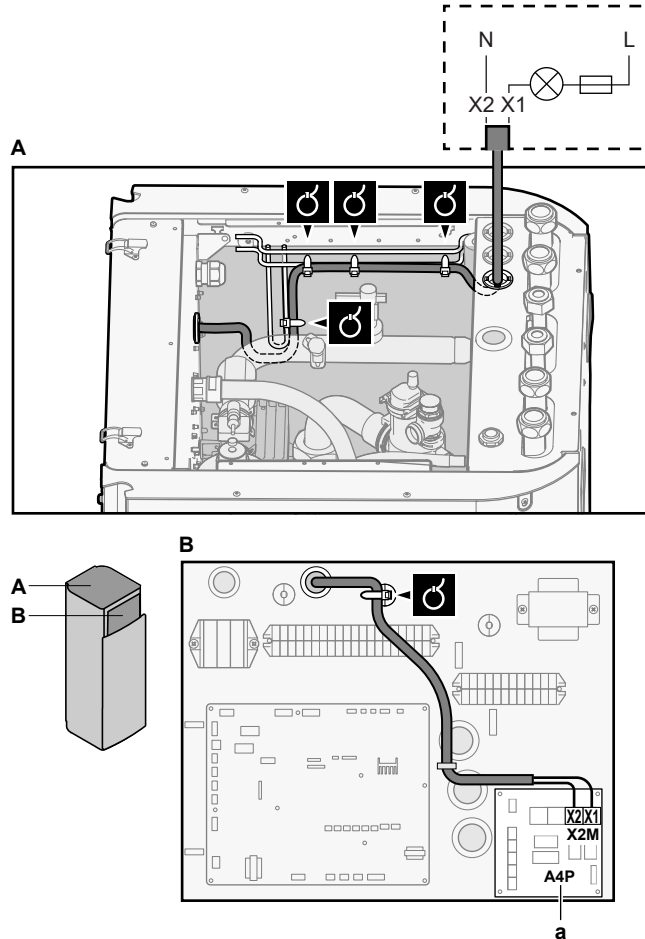

2 Connect the changeover to external heat source cable to the appropriate terminals as shown in the illustration below.



a Installation of EKR1HBAA is required.

3 Fix the cable with cable ties to the cable tie mountings.

8.3.9 To connect the power consumption digital inputs

	Wires: 2 (per input signal)×0.75 mm ² Power limitation digital inputs: 12 V DC / 12 mA detection (voltage supplied by PCB)
	[9.9] Power consumption control.

1 Open the following (see "To open the indoor unit" [▶ 60]):

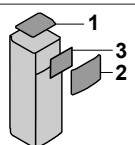
1	Top panel	
2	User interface panel	
3	Upper switch box cover	

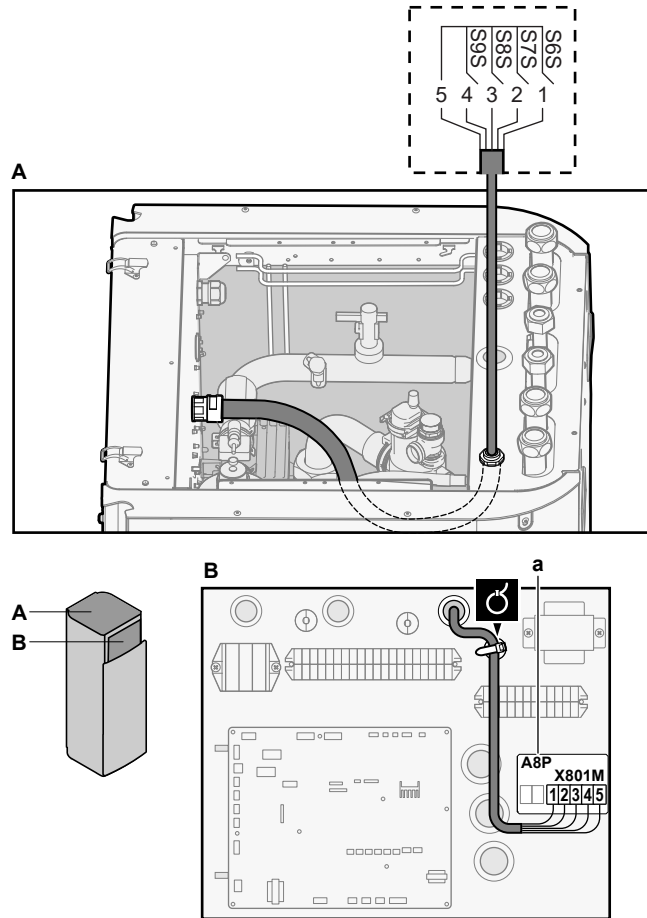

- 2 Connect the power consumption digital inputs cable to the appropriate terminals as shown in the illustration below.



a Installation of EKRPIAHTA is required.

- 3 Fix the cable with cable ties to the cable tie mountings.

8.3.10 To connect the safety thermostat (normally closed contact)

	<p>Wires: 2x0.75 mm² Maximum length: 50 m Safety thermostat contact: 16 V DC detection (voltage supplied by PCB). The voltage-free contact shall ensure the minimum applicable load of 15 V DC, 10 mA.</p>
	[9.8.1]=3 (Benefit kWh power supply = Safety thermostat)

- 1 Open the following (see "To open the indoor unit" [▶ 60]):

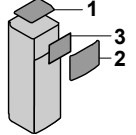
1	Top panel	
2	User interface panel	
3	Upper switch box cover	

- 2 Connect the safety thermostat (normally closed) cable to the appropriate terminals as shown in the illustration below.

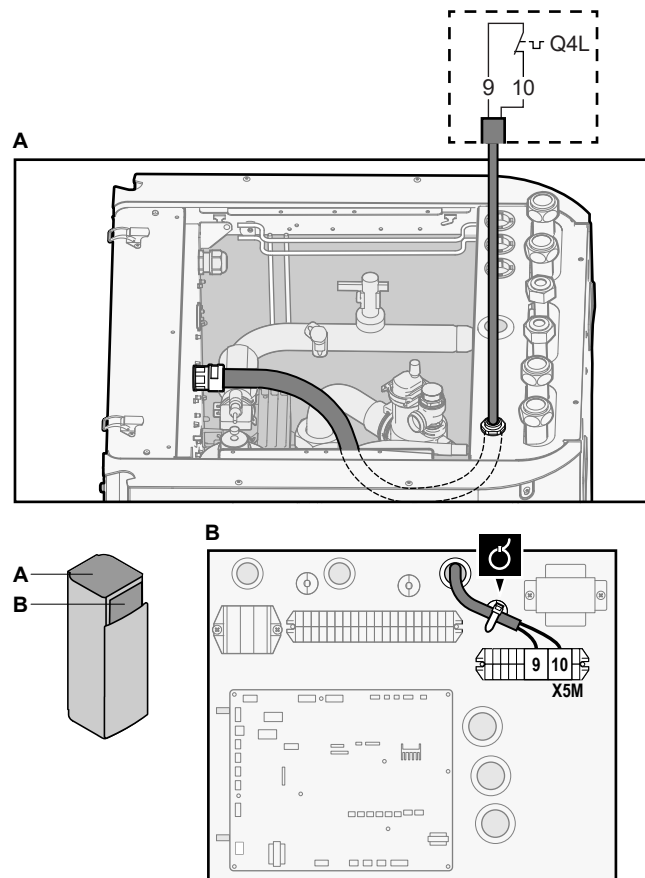

3 Fix the cable with cable ties to the cable tie mountings.



NOTICE

Make sure to select and install the safety thermostat according to the applicable legislation.

In any case, to prevent unnecessary tripping of the safety thermostat, we recommend the following:

- The safety thermostat is automatically resettable.
- The safety thermostat has a maximum temperature variation rate of 2°C/min.
- There is a minimum distance of 2 m between the safety thermostat and the 3-way valve.



INFORMATION

ALWAYS configure the safety thermostat after it is installed. Without configuration, the unit will ignore the safety thermostat contact.



INFORMATION

The preferential kWh rate power supply contact is connected to the same terminals (X5M/9+10) as the safety thermostat. Thus, the system can have EITHER preferential kWh rate power supply OR a safety thermostat.

8.4 After connecting the electrical wiring to the indoor unit

To prevent water ingress to the switch box, seal the low voltage wiring intake using the sealing tape (delivered as accessory).

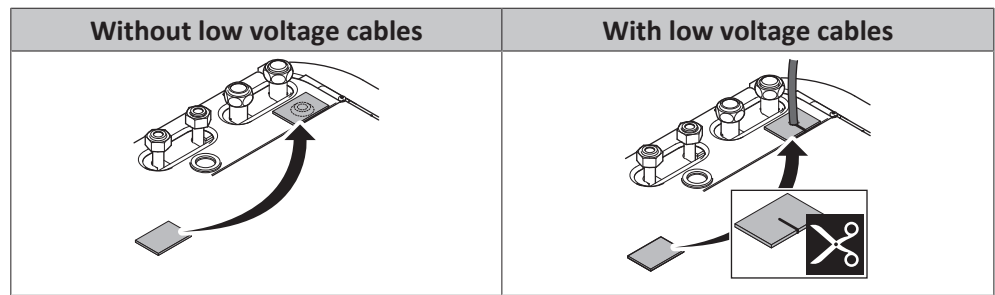

9 Configuration



INFORMATION

Cooling is only applicable in case of:

- Reversible models
- Heating only models + conversion kit (EKHVCONV2)

In this chapter

9.1	Overview: Configuration.....	115
9.1.1	To access the most used commands.....	116
9.2	Configuration wizard.....	118
9.3	Possible screens.....	119
9.3.1	Possible screens: Overview.....	119
9.3.2	Home screen.....	120
9.3.3	Main menu screen.....	123
9.3.4	Menu screen.....	124
9.3.5	Setpoint screen.....	124
9.3.6	Detailed screen with values.....	125
9.3.7	Schedule screen: Example.....	125
9.4	Weather-dependent curve.....	130
9.4.1	What is a weather-dependent curve?.....	130
9.4.2	2-points curve.....	130
9.4.3	Slope-offset curve.....	131
9.4.4	Using weather-dependent curves.....	133
9.5	Settings menu.....	135
9.5.1	Malfunctioning.....	135
9.5.2	Room.....	135
9.5.3	Main zone.....	139
9.5.4	Additional zone.....	149
9.5.5	Space heating/cooling.....	155
9.5.6	Tank.....	163
9.5.7	User settings.....	170
9.5.8	Information.....	175
9.5.9	Installer settings.....	176
9.5.10	Commissioning.....	194
9.5.11	Operation.....	194
9.5.12	WLAN.....	195
9.6	Menu structure: Overview user settings.....	197
9.7	Menu structure: Overview installer settings.....	198

9.1 Overview: Configuration

This chapter describes what you have to do and know to configure the system after it is installed.

Why

If you do NOT configure the system correctly, it might NOT work as expected. The configuration influences the following:

- The calculations of the software
- What you can see on and do with the user interface

How

You can configure the system via the user interface.

- **First time – Configuration wizard.** When you turn ON the user interface for the first time (via the unit), the configuration wizard starts to help you configure the system.

- **Restart the configuration wizard.** If the system is already configured, you can restart the configuration wizard. To restart the configuration wizard, go to **Installer settings > Configuration wizard**. To access **Installer settings**, see ["To access the most used commands"](#) [▶ 116].
- **Afterwards.** If necessary, you can make changes to the configuration in the menu structure or the overview settings.

i

INFORMATION

When the configuration wizard is finished, the user interface will show an overview screen and request to confirm. When confirmed, the system will restart and the home screen will be displayed.

Accessing settings – Legend for tables

You can access the installer settings using two different methods. However, NOT all settings are accessible via both methods. If so, the corresponding table columns in this chapter are set to N/A (not applicable).

Method	Column in tables
Accessing settings via the breadcrumb in the home menu screen or the menu structure . To enable breadcrumbs, press the ? button in the home screen.	# For example: [2.9]
Accessing settings via the code in the overview field settings .	Code For example: [C-07]





See also:

- ["To access the installer settings"](#) [▶ 117]
- ["9.7 Menu structure: Overview installer settings"](#) [▶ 198]

9.1.1 To access the most used commands

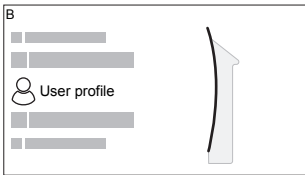
To change the user permission level

You can change the user permission level as follows:

1	Go to [B]: User profile . 	
2	Enter the applicable pin code for the user permission level. <ul style="list-style-type: none"> ▪ Browse through the list of digits and change the selected digit. ▪ Move the cursor from left to right. ▪ Confirm the pin code and proceed. 	<div style="margin-bottom: 5px;">—</div> <div style="margin-bottom: 5px;"></div> <div style="margin-bottom: 5px;"></div> <div></div>

Installer pin code

The **Installer** pin code is **5678**. Additional menu items and installer settings are now available.

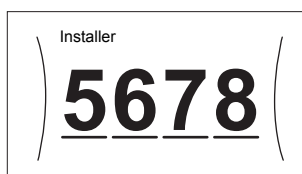

Advanced user pin code

The **Advanced user** pin code is **1234**. Additional menu items for the user are now visible.

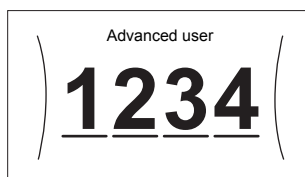

User pin code

The **User** pin code is **0000**.

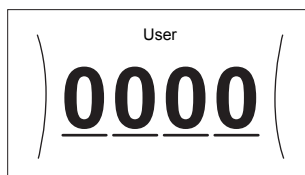

To access the installer settings



- 1 Set the user permission level to **Installer**.
- 2 Go to [9]: **Installer settings**.

To modify an overview setting

Example: Modify [1-01] from 15 to 20.

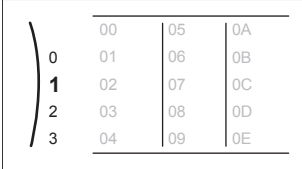
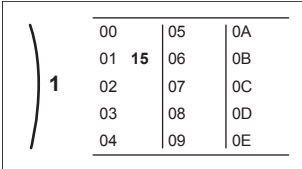
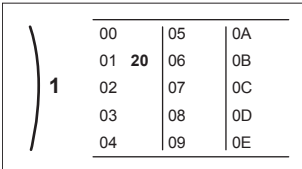
Most settings can be configured via the menu structure. If for any reason it is required to change a setting using the overview settings, then the overview settings can be accessed as follows:

1	Set the user permission level to Installer . See " To change the user permission level " [▶ 116].	—
2	Go to [9.]: Installer settings > Overview field settings .	🔍⋯○
3	Turn the left dial to select the first part of the setting and confirm by pressing the dial. 	🔍⋯○
4	Turn the left dial to select the second part of the setting 	🔍⋯○
5	Turn the right dial to modify the value from 15 to 20. 	○⋯○🔍

6	Press the left dial to confirm the new setting.	
7	Press the center button to go back to the home screen.	



INFORMATION

When you change the overview settings and you go back to the home screen, the user interface will show a popup screen and request to restart the system.

When confirmed, the system will restart and recent changes will be applied.

9.2 Configuration wizard

After first power ON of the system, the user interface will guide you using the configuration wizard. This way you can set the most important initial settings. This way the unit will be able to run properly. Afterwards, more detailed settings can be done via the menu structure if required.

You can find a short overview of the settings in the configuration here. All the settings can also be adjusted in the settings menu (use the breadcrumbs).

For the setting...	Refer to...
Language [7.1]	
Time/date [7.2]	
Hours	—
Minutes	
Year	
Month	
Day	
System	
Indoor unit type (read only)	"Installer settings" [▶ 176]
Backup heater type [9.3.1]	
Domestic hot water [9.2.1]	
Emergency [9.5]	
Number of zones [4.4]	"Space heating/cooling" [▶ 155]
Glycol Filled system (overview field setting [E-0D])	"Installer settings" [▶ 176]
Booster heater capacity [9.4.1] (if applicable)	
Backup heater	
Voltage [9.3.2]	"Backup heater" [▶ 178]
Configuration [9.3.3]	
Capacity step 1 [9.3.4]	
Additional capacity step 2 [9.3.5] (if applicable)	
Main zone	

For the setting...		Refer to...
Emitter type [2.7]		"Main zone" [▶ 139]
Control [2.9]		
Setpoint mode [2.4]		
Heating WD curve [2.5] (if applicable)		
Cooling WD curve [2.6] (if applicable)		
Schedule [2.1]		
WD curve type [2.E]		
Additional zone (only if [4.4]=1)		
Emitter type [3.7]		"Additional zone" [▶ 149]
Control (read only) [3.9]		
Setpoint mode [3.4]		
Heating WD curve [3.5] (if applicable)		
Cooling WD curve [3.6] (if applicable)		
Schedule [3.1]		
WD curve type [3.C] (read only)		
Tank		
Heat up mode [5.6]		"Tank" [▶ 163]
Comfort setpoint [5.2]		
Eco setpoint [5.3]		
Reheat setpoint [5.4]		
Hysteresis [5.9] and [5.A]		

9.3 Possible screens

9.3.1 Possible screens: Overview

The most common screens are as follows:

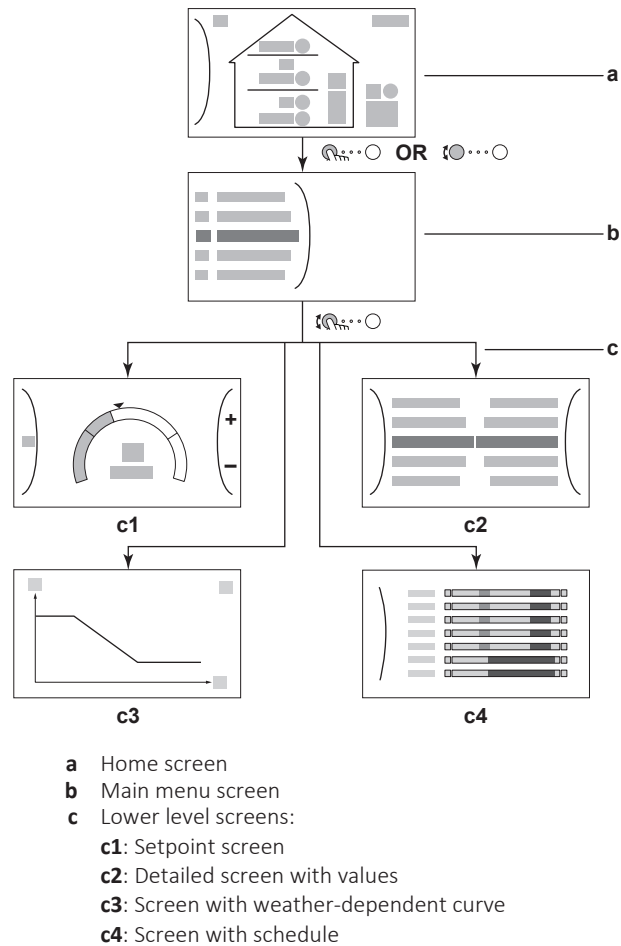





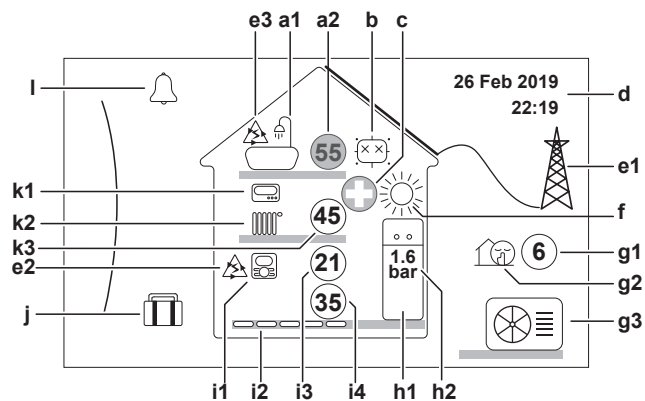



























9.3.2 Home screen

Press the button to go back to the home screen. You see an overview of the unit configuration and the room and setpoint temperatures. Only symbols applicable for your configuration are visible on the home screen.





Possible actions on this screen	
	Go through the list of the main menu.
	Go to the main menu screen.
?	Enable/disable breadcrumbs.

Item		Description
a	Domestic hot water	
	a1	 Domestic hot water
	a2	 Measured tank temperature ^(a)
b	Disinfection / Powerful	
		Disinfection mode active
		Powerful operation mode active
c	Emergency	
		Heat pump failure and system operates in Emergency mode or heat pump is forced off.
d	Current date and time	
e	Smart energy	
	e1	 Smart energy is available via solar panels or smart grid.
	e2	 Smart energy is currently being used for space heating.
	e3	 Smart energy is currently being used for domestic hot water.
f	Space operation mode	
		Cooling
		Heating
g	Outdoor / quiet mode	
	g1	 Measured outdoor temperature ^(a)
	g2	 Quiet mode active
	g3	 Outdoor unit
h	Indoor unit / domestic hot water tank	
	h1	 Floor-standing indoor unit with integrated tank
		 Wall-mounted indoor unit
		 Wall-mounted indoor unit with separated tank
	h2	 1.6 bar Water pressure

Item	Description
i	Main zone
i1	Installed room thermostat type:
	Unit operation is decided based on the ambient temperature of the dedicated Human Comfort Interface (BRC1HHDA used as room thermostat).
	Unit operation is decided by the external room thermostat (wired or wireless).
—	No room thermostat installed or set. Unit operation is decided based on the leaving water temperature regardless of the actual room temperature and/or heating demand of the room.
i2	Installed heat emitter type:
	Underfloor heating
	Fancoil unit
	Radiator
i3	 Measured room temperature ^(a)
i4	 Leaving water temperature setpoint ^(a)
j	Holiday mode
	Holiday mode active
k	Additional zone
k1	Installed room thermostat type:
	Unit operation is decided by the external room thermostat (wired or wireless).
—	No room thermostat installed or set. Unit operation is decided based on the leaving water temperature regardless of the actual room temperature and/or heating demand of the room.
k2	Installed heat emitter type:
	Underfloor heating
	Fancoil unit
	Radiator
k3	 Leaving water temperature setpoint ^(a)
l	Malfunction
	A malfunction occurred.
	See " To display the help text in case of a malfunction " [▶ 225] for more information.



^(a) If the corresponding operation (for example: space heating) is not active, the circle is greyed out.



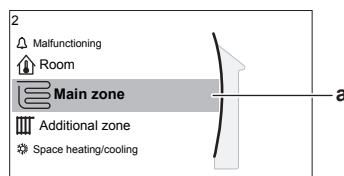







9.3.3 Main menu screen

Starting from the home screen, press () or turn () the left dial to open the main menu screen. From the main menu, you can access the different setpoint screens and submenus.



a Selected submenu

Possible actions on this screen	
	Go through the list.
	Enter the submenu.
?	Enable/disable breadcrumbs.

Submenu	Description
[0]  or  Malfunctioning	Restriction: Only displayed if a malfunction occurs. See " To display the help text in case of a malfunction " [▶ 225] for more information.
[1]  Room	Restriction: Only displayed if a dedicated Human Comfort Interface (BRC1HHDA used as room thermostat) is controlling the indoor unit. Set the room temperature.
[2]  Main zone	Shows the applicable symbol for your main zone emitter type. Set the leaving water temperature for the main zone.
[3]  Additional zone	Restriction: Only displayed if there are two leaving water temperature zones. Shows the applicable symbol for your additional zone emitter type. Set the leaving water temperature for the additional zone (if present).
[4]  Space heating/cooling	Shows the applicable symbol of your unit. Put the unit in heating mode or cooling mode. You cannot change the mode on heating only models.
[5]  Tank	Set the domestic hot water tank temperature.
[7]  User settings	Gives access to user settings such as holiday mode and quiet mode.
[8]  Information	Displays data and information about the indoor unit.
[9]  Installer settings	Restriction: Only for the installer. Gives access to advanced settings.

Submenu		Description
[A]	Commissioning	Restriction: Only for the installer. Perform tests and maintenance.
[B]	User profile	Change the active user profile.
[C]	Operation	Turn heating/cooling functionality and domestic hot water preparation on or off.
[D]	Wireless gateway	Restriction: Only displayed if a wireless LAN (WLAN) is installed. Contains settings needed when configuring the Daikin Residential Controller app.

9.3.4 Menu screen

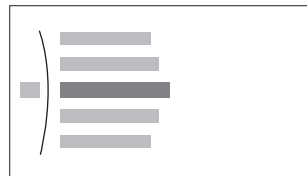

Example:

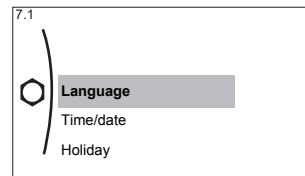

Possible actions on this screen	
	Go through the list.
	Enter the submenu/setting.

9.3.5 Setpoint screen

The setpoint screen is displayed for screens describing system components that need a setpoint value.

Examples

[1] Room temperature screen

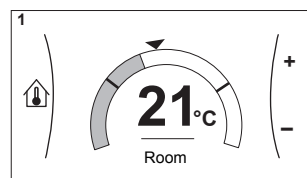

[2] Main zone screen

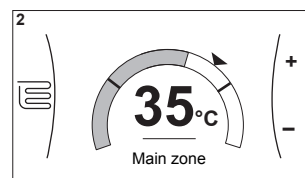

[3] Additional zone screen

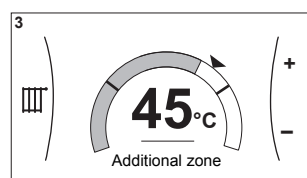

[5] Tank temperature screen

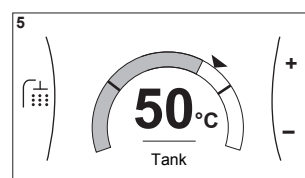

Explanation

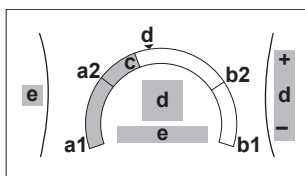

Possible actions on this screen	
	Go through the list of the submenu.
	Go to the submenu.
	Adjust and automatically apply the desired temperature.

Item	Description	
Minimum temperature limit	a1	Fixed by the unit
	a2	Restricted by the installer
Maximum temperature limit	b1	Fixed by the unit
	b2	Restricted by the installer
Current temperature	c	Measured by the unit
Desired temperature	d	Turn the right dial to increase/decrease.
SubMenu	e	Turn or press the left dial to go to the submenu.

9.3.6 Detailed screen with values

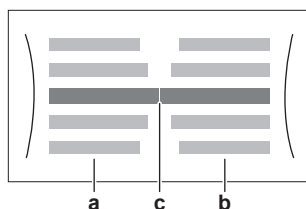

Example:

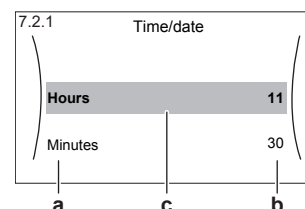

- a** Settings
- b** Values
- c** Selected setting and value

Possible actions on this screen	
	Go through the list of settings.
	Change the value.
	Go to the next setting.
	Confirm changes and proceed.

9.3.7 Schedule screen: Example

This example shows how to set a room temperature schedule in heating mode for the main zone.



INFORMATION

The procedures to program other schedules are similar.

To program the schedule: overview

Example: You want to program the following schedule:

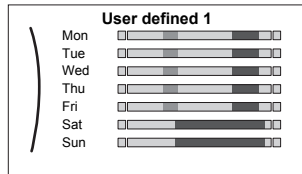

Prerequisite: The room temperature schedule is only available if room thermostat control is active. If leaving water temperature control is active, you can program the main zone schedule instead.

- 1 Go to the schedule.
- 2 (optional) Clear the content of the whole week schedule or the content of a selected day schedule.
- 3 Program the schedule for **Monday**.
- 4 Copy the schedule to the other weekdays.
- 5 Program the schedule for **Saturday** and copy it to **Sunday**.
- 6 Give the schedule a name.



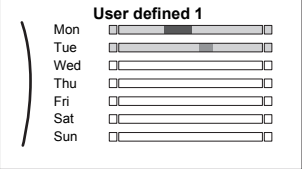
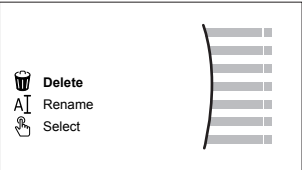

To go to the schedule

1	Go to [1.1]: Room > Schedule .	
2	Set scheduling to Yes .	
3	Go to [1.2]: Room > Heating schedule .	



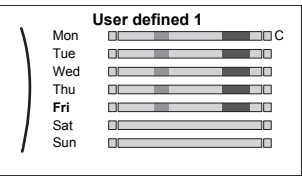



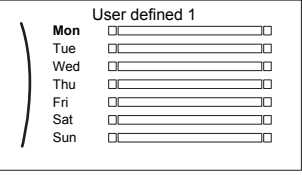

To clear the content of the week schedule

1	Select the name of the current schedule. 	
2	Select Delete . 	
3	Select OK to confirm.	



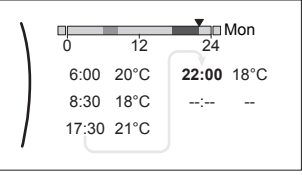



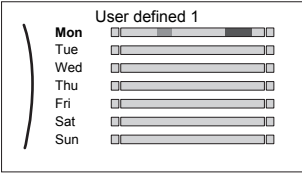

To clear the content of a day schedule

1	<p>Select the day of which you want to clear the content. For example Friday</p> 	
2	<p>Select Delete.</p> 	
3	<p>Select OK to confirm.</p>	

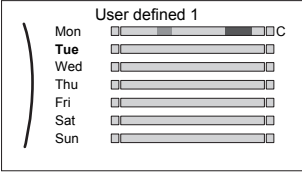

To program the schedule for Monday

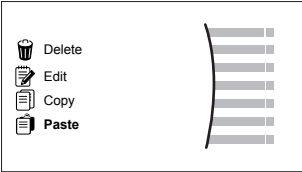
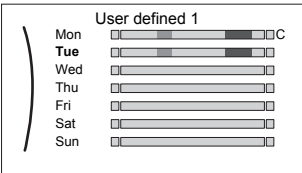

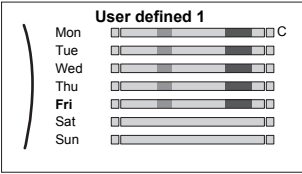



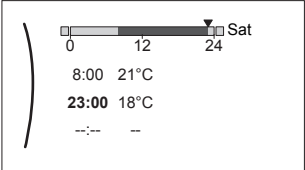

1	<p>Select Monday.</p> 	
2	<p>Select Edit.</p> 	
3	<p>Use the left dial to select an entry and edit the entry with the right dial. You can program up to 6 actions each day. On the bar, a high temperature has a darker colour than a low temperature.</p>  <p>Note: To clear an action, set its time as the time of the previous action.</p>	 
4	<p>Confirm the changes.</p> <p>Result: The schedule for Monday is defined. The value of the last action is valid until the next programmed action. In this example, Monday is the first day you programmed. Thus, the last programmed action is valid up to the first action of next Monday.</p>	

To copy the schedule to the other weekdays





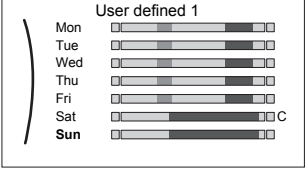

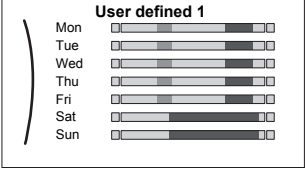

<p>1</p>	<p>Select Monday.</p> 	
<p>2</p>	<p>Select Copy.</p>  <p>Result: Next to the copied day, "C" is displayed.</p>	
<p>3</p>	<p>Select Tuesday.</p> 	
<p>4</p>	<p>Select Paste.</p>  <p>Result:</p> 	
<p>5</p>	<p>Repeat this action for all other weekdays.</p> 	<p>—</p>

To program the schedule for Saturday and copy it to Sunday

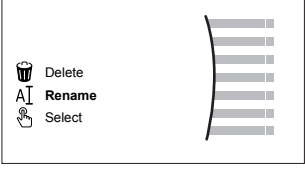
<p>1</p>	<p>Select Saturday.</p>	
<p>2</p>	<p>Select Edit.</p>	

3	<p>Use the left dial to select an entry and edit the entry with the right dial.</p> 	 
4	Confirm the changes.	
5	Select Saturday .	
6	Select Copy .	
7	Select Sunday .	
8	<p>Select Paste.</p> <p>Result:</p> 	

To rename the schedule

1	<p>Select the name of the current schedule.</p> 	
2	<p>Select Rename.</p> 	
3	<p>(optional) To delete the current schedule name, browse through the character list until ← is displayed, then press to remove the previous character. Repeat for each character of the schedule name.</p>	 
4	<p>To name the current schedule, browse through the character list and confirm the selected character. The schedule name can contain up to 15 characters.</p>	 
5	Confirm the new name.	



INFORMATION

Not all schedules can be renamed.

9.4 Weather-dependent curve

9.4.1 What is a weather-dependent curve?

Weather-dependent operation

The unit operates 'weather dependent' if the desired leaving water or tank temperature is determined automatically by the outdoor temperature. It therefore is connected to a temperature sensor on the North wall of the building. If the outdoor temperature drops or rises, the unit compensates instantly. Thus, the unit does not have to wait for feedback by the thermostat to increase or decrease the temperature of the leaving water or tank. Because it reacts more quickly, it prevents high rises and drops of the indoor temperature and water temperature at tap points.

Advantage

Weather-dependent operation reduces energy consumption.

Weather-dependent curve

To be able to compensate for differences in temperature, the unit relies on its weather-dependent curve. This curve defines how much the temperature of the tank or leaving water must be at different outdoor temperatures. Because the slope of the curve depends on local circumstances such as climate and the insulation of the house, the curve can be adjusted by an installer or user.

Types of weather-dependent curve

There are 2 types of weather-dependent curves:

- 2-points curve
- Slope-offset curve

Which type of curve you use to make adjustments, depends on your personal preference. See "[Using weather-dependent curves](#)" [▶ 133].

Availability

The weather-dependent curve is available for:

- Main zone - Heating
- Main zone - Cooling
- Additional zone - Heating
- Additional zone - Cooling
- Tank (only available to installers)



INFORMATION

To operate weather dependent, correctly configure the setpoint of the main zone, additional zone or tank. See "[Using weather-dependent curves](#)" [▶ 133].

9.4.2 2-points curve

Define the weather-dependent curve with these two setpoints:



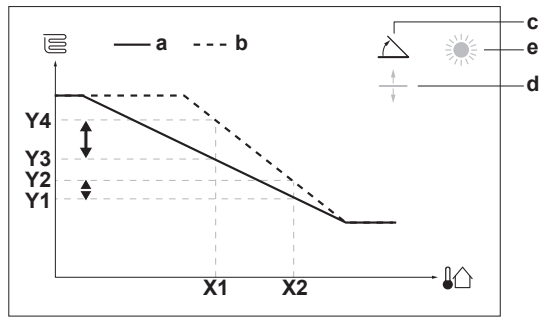

- Setpoint (X1, Y2)
- Setpoint (X2, Y1)

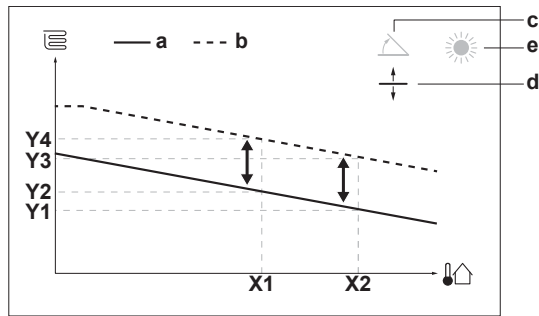

Weather-dependent curve when offset is selected:



Item	Description
a	WD curve before changes.
b	WD curve after changes (as example): <ul style="list-style-type: none"> ▪ When slope is changed, the new preferred temperature at X1 is unequally higher than the preferred temperature at X2. ▪ When offset is changed, the new preferred temperature at X1 is equally higher as the preferred temperature at X2.
c	Slope
d	Offset
e	Selected weather dependent zone: <ul style="list-style-type: none"> ▪ ☀: Main zone or additional zone heating ▪ ❄: Main zone or additional zone cooling ▪ 🏠: Domestic hot water
X1, X2	Examples of outdoor ambient temperature
Y1, Y2, Y3, Y4	Examples of desired tank temperature or leaving water temperature. The icon corresponds to the heat emitter for that zone: <ul style="list-style-type: none"> ▪ 🏠: Underfloor heating ▪ 🏠: Fan coil unit ▪ 🏠: Radiator ▪ 🏠: Domestic hot water tank

Possible actions on this screen	
	Select slope or offset.
	Increase or decrease the slope/offset.
	When slope is selected: set slope and go to offset. When offset is selected: set offset.
	Confirm changes and return to the submenu.

9.4.4 Using weather-dependent curves

Configure weather-dependent curves as following:

To define the setpoint mode

To use the weather-dependent curve, you need to define the correct setpoint mode:

Go to setpoint mode ...	Set the setpoint mode to ...
Main zone – Heating	
[2.4] Main zone > Setpoint mode	WD heating, fixed cooling OR Weather dependent
Main zone – Cooling	
[2.4] Main zone > Setpoint mode	Weather dependent
Additional zone – Heating	
[3.4] Additional zone > Setpoint mode	WD heating, fixed cooling OR Weather dependent
Additional zone – Cooling	
[3.4] Additional zone > Setpoint mode	Weather dependent
Tank	
[5.B] Tank > Setpoint mode	Restriction: Only available to installers. Weather dependent

To change the type of weather-dependent curve

To change the type for all zones (main + additional) and for the tank, go to [2.E] Main zone > WD curve type.

Viewing which type is selected is also possible via:

- [3.C] Additional zone > WD curve type
- [5.E] Tank > WD curve type

Restriction: Only available to installers.

To change the weather-dependent curve

Zone	Go to ...
Main zone – Heating	[2.5] Main zone > Heating WD curve
Main zone – Cooling	[2.6] Main zone > Cooling WD curve

Zone	Go to ...
Additional zone – Heating	[3.5] Additional zone > Heating WD curve
Additional zone – Cooling	[3.6] Additional zone > Cooling WD curve
Tank	Restriction: Only available to installers. [5.C] Tank > WD curve

**INFORMATION****Maximum and minimum setpoints**

You cannot configure the curve with temperatures that are higher or lower than the set maximum and minimum setpoints for that zone or for the tank. When the maximum or minimum setpoint is reached, the curve flattens out.

To fine-tune the weather-dependent curve: slope-offset curve

The following table describes how to fine-tune the weather-dependent curve of a zone or tank:

You feel ...		Fine-tune with slope and offset:	
At regular outdoor temperatures ...	At cold outdoor temperatures ...	Slope	Offset
OK	Cold	↑	—
OK	Hot	↓	—
Cold	OK	↓	↑
Cold	Cold	—	↑
Cold	Hot	↓	↑
Hot	OK	↑	↓
Hot	Cold	↑	↓
Hot	Hot	—	↓

To fine-tune the weather-dependent curve: 2-points curve

The following table describes how to fine-tune the weather-dependent curve of a zone or tank:



You feel ...		Fine-tune with setpoints:			
At regular outdoor temperatures ...	At cold outdoor temperatures ...	Y2 ^(a)	Y1 ^(a)	X1 ^(a)	X2 ^(a)
OK	Cold	↑	—	↑	—
OK	Hot	↓	—	↓	—
Cold	OK	—	↑	—	↑
Cold	Cold	↑	↑	↑	↑
Cold	Hot	↓	↑	↓	↑
Hot	OK	—	↓	—	↓
Hot	Cold	↑	↓	↑	↓
Hot	Hot	↓	↓	↓	↓

^(a) See "2-points curve" [▶ 130].

9.5 Settings menu

You can set additional settings using the main menu screen and its submenus. The most important settings are presented here.

9.5.1 Malfunctioning

In case of a malfunction,  or  will appear on the home screen. To display the error code, open the menu screen and go to [0] **Malfunctioning**. Press **?** for more information about the error.

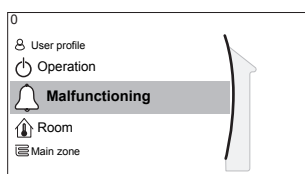

9.5.2 Room

Overview

The following items are listed in the submenu:

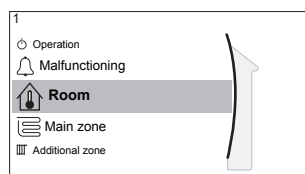

[1] Room

 Setpoint screen

[1.1] Schedule

[1.2] Heating schedule

[1.3] Cooling schedule

[1.4] Antifrost

[1.5] Setpoint range

[1.6] Room sensor offset

[1.7] Room sensor offset

Setpoint screen

Control the room temperature of the main zone via setpoint screen [1] **Room**.

See "Setpoint screen" [▶ 124].

Schedule

Indicate if the room temperature is controlled according to a schedule or not.

#	Code	Description
[1.1]	N/A	Schedule: <ul style="list-style-type: none"> ▪ No: Room temperature is directly controlled by the user. ▪ Yes: Room temperature is controlled by a schedule and can be modified by the user.

Heating schedule

Applicable for all models.

Define a heating schedule of the room temperature in [1.2] **Heating schedule**.
See "[Schedule screen: Example](#)" [▶ 125].

Cooling schedule

Only applicable for reversible models.

Define a cooling schedule of the room temperature in [1.3] **Cooling schedule**.
See "[Schedule screen: Example](#)" [▶ 125].

Antifrost

[1.4] **Antifrost** prevents the room from getting too cold. This setting is applicable when [2.9] **Control=Room thermostat**, but also offers functionality for leaving water temperature control and external room thermostat control. In case of the latter two, **Antifrost** can be activated by setting field setting [2-06]=1.

Room frost protection, when enabled, is not guaranteed when there is no room thermostat that can activate the heat pump. This is the case when:

- [2.9] **Control=External room thermostat** and [C.2] **Space heating/cooling=Off**, or if
- [2.9] **Control=Leaving water**.

In the above cases, **Antifrost** will heat the space heating water to a reduced setpoint when the outdoor temperature is lower than 6°C.

Main zone unit control method [2.9]	Description
Leaving water temperature control ([C-07]=0)	Room frost protection is NOT guaranteed.
External room thermostat control ([C-07]=1)	Allow for the external room thermostat to take care of room frost protection: <ul style="list-style-type: none"> ▪ Set [C.2] Space heating/cooling=On.
Room thermostat control ([C-07]=2)	Allow for the dedicated Human Comfort Interface (BRC1HHDA used as room thermostat) to take care of room frost protection: <ul style="list-style-type: none"> ▪ Set antifrost [1.4.1] Activation=Yes. ▪ Set the temperature of the antifrost function in [1.4.2] Room setpoint.



INFORMATION
If a U4 error occurs, room frost protection is NOT guaranteed.



NOTICE
If the room **Antifrost** setting is active and a U4 error occurs, the unit will automatically start the **Antifrost** function via the backup heater. If the backup heater is not allowed for room frost protection during a U4 error, the room **Antifrost** setting MUST be disabled.

**NOTICE**

Room frost protection. Even if you turn OFF space heating/cooling operation ([C.2]: Operation > Space heating/cooling), room frost protection operation –if enabled– can still activate. However, for leaving water temperature control and external room thermostat control, the protection is NOT guaranteed.

For more detailed information about room frost protection in relation to the applicable unit control method, see the sections below.

Leaving water temperature control ([C-07]=0)

Under leaving water temperature control, room frost protection is NOT guaranteed. However, if room antifrost [2-06] is activated, limited frost protection by the unit is possible:

If...	Then...
<ul style="list-style-type: none"> ▪ Space heating/cooling=Off, and ▪ Outdoor ambient temperature drops below 6°C 	<ul style="list-style-type: none"> ▪ The unit will supply leaving water to the heat emitters to heat up the room again, and ▪ the temperature setpoint of the leaving water will be lowered.
<ul style="list-style-type: none"> ▪ Space heating/cooling=On, and ▪ Operation mode=Heating 	The unit will supply leaving water to the heat emitters to heat up the room according to normal logic.
<ul style="list-style-type: none"> ▪ Space heating/cooling=On, and ▪ Operation mode=Cooling 	There is no room frost protection.

External room thermostat control ([C-07]=1)

Under external room thermostat control, room frost protection is guaranteed by the external room thermostat, provided that:

- [C.2] Space heating/cooling=On, and
- [9.5.1] Emergency=Automatic or auto SH normal/DHW off.

However, if [1.4.1] Antifrost is activated, limited frost protection by the unit is possible.

In case of 1 leaving water temperature zone:

If...	Then...
<ul style="list-style-type: none"> ▪ Space heating/cooling=Off, and ▪ Outdoor ambient temperature drops below 6°C 	<ul style="list-style-type: none"> ▪ The unit will supply leaving water to the heat emitters to heat up the room again, and ▪ the temperature setpoint of the leaving water will be lowered.
<ul style="list-style-type: none"> ▪ Space heating/cooling=On, and ▪ The external room thermostat is "Thermo OFF", and ▪ Outdoor temperature drops below 6°C 	<ul style="list-style-type: none"> ▪ The unit will supply leaving water to the heat emitters to heat up the room again, and ▪ the temperature setpoint of the leaving water will be lowered.
<ul style="list-style-type: none"> ▪ Space heating/cooling=On, and ▪ The external room thermostat is "Thermo ON" 	Room frost protection is guaranteed by the normal logic.

In case of 2 leaving water temperature zones:

If...	Then...
<ul style="list-style-type: none"> ▪ Space heating/cooling=Off, and ▪ Outdoor ambient temperature drops below 6°C 	<ul style="list-style-type: none"> ▪ The unit will supply leaving water to the heat emitters to heat up the room again, and ▪ the temperature setpoint of the leaving water will be lowered.
<ul style="list-style-type: none"> ▪ Space heating/cooling=On, and ▪ Operation mode=Heating, and ▪ The external room thermostat is "Thermo OFF", and ▪ Outdoor temperature drops below 6°C 	<ul style="list-style-type: none"> ▪ The unit will supply leaving water to the heat emitters to heat up the room again, and ▪ the temperature setpoint of the leaving water will be lowered.
<ul style="list-style-type: none"> ▪ Space heating/cooling=On, and ▪ Operation mode=Cooling 	There is no room frost protection.

Room thermostat control ([C-07]=2)

During room thermostat control, room frost protection [2-06] is guaranteed when activated. If so, and the room temperature drops below the room antifrost temperature [2-05], the unit will supply leaving water to the heat emitters to heat up the room again.

#	Code	Description
[1.4.1]	[2-06]	Activation: <ul style="list-style-type: none"> ▪ 0 No: Antifrost functionality is OFF. ▪ 1 Yes: Antifrost functionality is on.
[1.4.2]	[2-05]	Room setpoint: <ul style="list-style-type: none"> ▪ 4°C~16°C



INFORMATION

When the dedicated Human Comfort Interface (BRC1HHDA used as room thermostat) is disconnected (because of incorrect wiring or damage of the cable), then room frost protection is NOT guaranteed.



NOTICE

If **Emergency** is set to **Manual** ([9.5.1]=0), and the unit is triggered to start emergency operation, the unit will stop and needs to be recovered manually via the user interface. To recover operation manually, go to the **Malfunctioning** main menu screen, and confirm emergency operation before starting.

Room frost protection is active even if the user does not confirm emergency operation.

Setpoint range

Only applicable in room thermostat control.

To save energy by preventing overheating or undercooling the room, you can limit the range of the room temperature for heating and/or cooling.



NOTICE

When adjusting the room temperature ranges, all desired room temperatures are also adjusted to guarantee they are between the limits.

#	Code	Description
[1.5.1]	[3-07]	Heating minimum
[1.5.2]	[3-06]	Heating maximum
[1.5.3]	[3-09]	Cooling minimum
[1.5.4]	[3-08]	Cooling maximum

Room sensor offset

Only applicable in room thermostat control.

To calibrate the (external) room temperature sensor, give an offset to the value of the room thermistor as measured by the Human Comfort Interface (BRC1HHDA used as room thermostat) or by the external room sensor. The setting can be used to compensate for situations where the Human Comfort Interface or the external room sensor cannot be installed at the ideal location.

See "[5.7 Setting up an external temperature sensor](#)" [▶ 52].

#	Code	Description
[1.6]	[2-0A]	Room sensor offset (Human Comfort Interface (BRC1HHDA used as room thermostat)): Offset on the actual room temperature measured by the Human Comfort Interface. <ul style="list-style-type: none"> ▪ $-5^{\circ}\text{C}\sim 5^{\circ}\text{C}$, step 0.5°C
[1.7]	[2-09]	Room sensor offset (external room sensor option): Only applicable if the external room sensor option is installed and configured. <ul style="list-style-type: none"> ▪ $-5^{\circ}\text{C}\sim 5^{\circ}\text{C}$, step 0.5°C

9.5.3 Main zone

Overview

The following items are listed in the submenu:

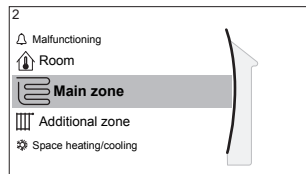

[2] Main zone

- [2] Setpoint screen
 - [2.1] Schedule
 - [2.2] Heating schedule
 - [2.3] Cooling schedule
 - [2.4] Setpoint mode
 - [2.5] Heating WD curve
 - [2.6] Cooling WD curve
 - [2.7] Emitter type
 - [2.8] Setpoint range
 - [2.9] Control
 - [2.A] Thermostat type
 - [2.B] Delta T
 - [2.C] Modulation
 - [2.D] Shut off valve
 - [2.E] WD curve type

Setpoint screen

Control the leaving water temperature for the main zone via setpoint screen [2] **Main zone**.

See "[Setpoint screen](#)" [▶ 124].

Schedule

Indicate if the temperature of the leaving water is defined according to a schedule or not.

Influence of the LWT setpoint mode [2.4] is as follows:

- In **Fixed** LWT setpoint mode, the scheduled actions consist of desired leaving water temperatures, either preset or custom.
- In **Weather dependent** LWT setpoint mode, the scheduled actions consist of desired shift actions, either preset or custom.

#	Code	Description
[2.1]	N/A	Schedule: <ul style="list-style-type: none"> ▪ 0: No ▪ 1: Yes

Heating schedule

Define a heating temperature schedule for the main zone via [2.2] **Heating schedule**.

See "[Schedule screen: Example](#)" [▶ 125].

Cooling schedule

Define a cooling temperature schedule for the main zone via [2.3] **Cooling schedule**.

See "[Schedule screen: Example](#)" [▶ 125].

Setpoint mode

Define the setpoint mode:

- **Fixed:** the desired leaving water temperature does not depend on the outdoor ambient temperature.
- In **WD heating, fixed cooling** mode, the desired leaving water temperature:
 - depends on the outdoor ambient temperature for heating
 - does NOT depend on the outdoor ambient temperature for cooling
- In **Weather dependent** mode, the desired leaving water temperature depends on the outdoor ambient temperature.

#	Code	Description
[2.4]	N/A	Setpoint mode: <ul style="list-style-type: none"> ▪ Fixed ▪ WD heating, fixed cooling ▪ Weather dependent

When weather dependent operation is active, low outdoor temperatures will result in warmer water and vice versa. During weather dependent operation, the user can shift the water temperature up or down by a maximum of 10°C.

Heating WD curve

Set weather-dependent heating for the main zone (if [2.4]=1 or 2):

#	Code	Description
[2.5]	[1-00] [1-01] [1-02] [1-03]	<p>Set weather-dependent heating in [2.5] Heating WD curve:</p> <p>T_t Target leaving water temperature (main zone) T_a Outdoor temperature</p> <p>Set weather-dependent heating in [9.1] Overview field settings:</p> <ul style="list-style-type: none"> ▪ [1-00]: Low outdoor ambient temperature. $-40^{\circ}\text{C}\sim+5^{\circ}\text{C}$ ▪ [1-01]: High outdoor ambient temperature. $10^{\circ}\text{C}\sim25^{\circ}\text{C}$ ▪ [1-02]: Desired leaving water temperature when the outdoor temperature equals or drops below the low ambient temperature. $[9-01]^{\circ}\text{C}\sim[9-00]^{\circ}\text{C}$ <p>Note: This value should be higher than [1-03] as for low outdoor temperatures warmer water is required.</p> <ul style="list-style-type: none"> ▪ [1-03]: Desired leaving water temperature when the outdoor temperature equals or rises above the high ambient temperature. $[9-01]^{\circ}\text{C}\sim\min(45, [9-00])^{\circ}\text{C}$ <p>Note: This value should be lower than [1-02] as for high outdoor temperatures less warm water is required.</p>

Cooling WD curve

Set weather-dependent cooling for the main zone (if [2.4]=2):

#	Code	Description
[2.6]	[1-06] [1-07] [1-08] [1-09]	<p>Set weather-dependent cooling in [2.6] Cooling WD curve:</p> <p>T_t Target leaving water temperature (main zone) T_a Outdoor temperature</p> <p>Set weather-dependent heating in [9.l] Overview field settings:</p> <ul style="list-style-type: none"> ▪ [1-06]: Low outdoor ambient temperature. 10°C~25°C ▪ [1-07]: High outdoor ambient temperature. 25°C~43°C ▪ [1-08]: Desired leaving water temperature when the outdoor temperature equals or drops below the low ambient temperature. [9-03]°C~[9-02]°C <p>Note: This value should be higher than [1-09] as for low outdoor temperatures less cold water is required.</p> <ul style="list-style-type: none"> ▪ [1-09]: Desired leaving water temperature when the outdoor temperature equals or rises above the high ambient temperature. [9-03]°C~[9-02]°C <p>Note: This value should be lower than [1-08] as for high outdoor temperatures colder water is required.</p>

Emitter type

Heating up or cooling down the main zone can take longer. This depends on:

- The water volume of the system
- The heater emitter type of the main zone

The setting **Emitter type** can compensate for a slow or a quick heating/cooling system during the heat up/cool down cycle. In room thermostat control, **Emitter type** influences the maximum modulation of the desired leaving water temperature, and the possibility for usage of the automatic cooling/heating changeover based on the indoor ambient temperature.

It is important to set **Emitter type** correctly and in accordance with your system layout. The target delta T for the main zone depends on it.

#	Code	Description
[2.7]	[2-0C]	Emitter type: <ul style="list-style-type: none"> ▪ 0: Underfloor heating ▪ 1: Fancoil unit ▪ 2: Radiator

The setting **Emitter type** influences the space heating setpoint range and the target delta T in heating as follows:

Emitter type Main zone	Space heating setpoint range [9-01]~[9-00]	Target delta T in heating [1-0B]
0: Underfloor heating	Maximum 55°C	Variable (see [2.B.1])
1: Fancoil unit	Maximum 55°C	Variable (see [2.B.1])
2: Radiator	Maximum 70°C	Fixed 10°C



NOTICE

The maximum setpoint in space heating depends on the emitter type as can be seen in above table. If there are 2 water temperature zones, then the maximum setpoint is the maximum of the 2 zones.



NOTICE

NOT configuring the system in the following way can cause damage to the heat emitters. If there are 2 zones, it is important that in heating:

- the zone with the lowest water temperature is configured as the main zone, and
- the zone with the highest water temperature is configured as the additional zone.



NOTICE

If there are 2 zones and the emitter types are wrongly configured, water of high temperature can be sent towards a low temperature emitter (underfloor heating). To avoid this:

- Install an aquastat/thermostatic valve to avoid too high temperatures towards a low temperature emitter.
- Make sure you set the emitter types for the main zone [2.7] and for the additional zone [3.7] correctly in accordance with the connected emitter.



NOTICE

Average emitter temperature = Leaving water temperature – (Delta T)/2

This means that for a same leaving water temperature setpoint, the average emitter temperature of radiators is lower than that of underfloor heating because of a bigger delta T.

Example radiators: $40 - 10 / 2 = 35^{\circ}\text{C}$

Example underfloor heating: $40 - 5 / 2 = 37.5^{\circ}\text{C}$

To compensate, you can:

- Increase the weather-dependent curve desired temperatures [2.5].
- Enable leaving water temperature modulation and increase the maximum modulation [2.C].

Setpoint range

To prevent a wrong (i.e. too hot or too cold) leaving water temperature for the main leaving water temperature zone, limit its temperature range.



NOTICE

In case of a floor heating application it is important to limit the:

- maximum leaving water temperature at heating operation according to the specifications of the floor heating installation.
- the minimum leaving water temperature at cooling operation to 18~20°C to prevent condensation on the floor.



NOTICE

- When adjusting the leaving water temperature ranges, all desired leaving water temperatures are also adjusted to guarantee they are between the limits.
- Always balance between the desired leaving water temperature with the desired room temperature and/or the capacity (according to the design and selection of the heat emitters). The desired leaving water temperature is the result of several settings (preset values, shift values, weather-dependent curves, modulation). As a result, too high or too low leaving water temperatures could occur which lead to overtemperatures or capacity shortage. By limiting the leaving water temperature range to adequate values (depending on the heat emitter), such situations can be avoided.

Example: In heating mode, leaving water temperatures must be sufficiently higher than the room temperatures. To avoid that the room cannot heat up as desired, set the minimum leaving water temperature to 28°C.

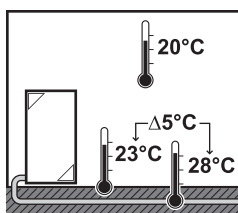

#	Code	Description
		Leaving water temperature range for the main leaving water temperature zone (= the leaving water temperature zone with the lowest leaving water temperature in heating operation and the highest leaving water temperature in cooling operation)
[2.8.1]	[9-01]	Heating minimum: <ul style="list-style-type: none"> ▪ 15°C~37°C
[2.8.2]	[9-00]	Heating maximum: <ul style="list-style-type: none"> ▪ [2-0C]=2 (emitter type main zone = radiator) 37°C~70°C ▪ Else: 37°C~55°C
[2.8.3]	[9-03]	Cooling minimum: <ul style="list-style-type: none"> ▪ 5°C~18°C
[2.8.4]	[9-02]	Cooling maximum: <ul style="list-style-type: none"> ▪ 18°C~22°C

Control

Define how the operation of the unit is controlled.

Control	In this control...
Leaving water	Unit operation is decided based on the leaving water temperature regardless the actual room temperature and/or heating or cooling demand of the room.
External room thermostat	Unit operation is decided by the external thermostat or equivalent (e.g. heat pump convector).
Room thermostat	Unit operation is decided based on the ambient temperature of the dedicated Human Comfort Interface (BRC1HHDA used as room thermostat).

#	Code	Description
[2.9]	[C-07]	<ul style="list-style-type: none"> ▪ 0: Leaving water ▪ 1: External room thermostat ▪ 2: Room thermostat

Thermostat type

Only applicable in external room thermostat control.



NOTICE

If an external room thermostat is used, the external room thermostat will control the room frost protection. However, the room frost protection is only possible if [C.2] Space heating/cooling=On.

#	Code	Description
[2.A]	[C-05]	<p>External room thermostat type for the main zone:</p> <ul style="list-style-type: none"> ▪ 1: 1 contact: The used external room thermostat can only send a thermo ON/OFF condition. There is no separation between heating or cooling demand. The room thermostat is connected to only 1 digital input (X2M/35). Select this value in case of a connection to the heat pump convector (FWXV). ▪ 2: 2 contacts: The used external room thermostat can send a separate heating/cooling thermo ON/OFF condition. The room thermostat is connected to 2 digital inputs (X2M/35 and X2M/34). Select this value in case of a connection to multi-zoning wired controls (see "Possible options for the indoor unit" [▶ 23]) or wireless room thermostat (EKRTR1).

Leaving water temperature: Delta T

In heating for the main zone, the target delta T (temperature difference) depends on the selected emitter type for the main zone.

Delta T is the absolute value of the temperature difference between the leaving water and entering water.

The unit is designed to support underfloor loops operation. The recommended leaving water temperature for underfloor loops is 35°C. In such case, the unit will realize a temperature difference of 5°C, which means that the entering water temperature is around 30°C.

Depending on the installed type of heat emitters (radiators, heat pump convector, underfloor loops) or situation, you can change the difference between entering and leaving water temperature.

Note: The pump will regulate its flow to keep the delta T. In some special cases, the measured delta T can differ from the set value.



INFORMATION

When only the backup heater is active in heating, delta T will be controlled according to the fixed capacity of the backup heater. It is possible that this delta T is different from the selected target delta T.



INFORMATION

In heating, the target delta T will only be achieved after some operation time, when the setpoint is being reached, because of the big difference between leaving water temperature setpoint and inlet temperature at startup.



INFORMATION

If the main zone or the additional zone has a heating demand, and this zone is equipped with radiators, then the target delta T that the unit will use in heating operation will be 10°C fixed.

If the zones are not equipped with radiators, then in heating the unit will give priority to the target delta T for the additional zone, if there is a heating demand in the additional zone.

In cooling the unit will give priority to the target delta T for the additional zone, if there is a cooling demand in the additional zone.

#	Code	Description
[2.B.1]	[1-0B]	<p>Delta T heating: A minimum temperature difference is required for proper operation of heat emitters in heating mode.</p> <ul style="list-style-type: none"> ▪ If [2-0C]=2, this is fixed to 10°C ▪ Else: 3°C~10°C
[2.B.2]	[1-0D]	<p>Delta T cooling: A minimum temperature difference is required for proper operation of heat emitters in cooling mode.</p> <ul style="list-style-type: none"> ▪ 3°C~10°C

Leaving water temperature: Modulation

Only applicable in case of room thermostat control.

When using the room thermostat functionality, the customer needs to set the desired room temperature. The unit will supply hot water to the heat emitters and the room will be heated.

Additionally, also the desired leaving water temperature must be configured: if **Modulation** is enabled, the unit automatically calculates the desired leaving water temperature. These calculations are based on:

- the preset temperatures, or
- the desired weather-dependent temperatures (if weather-dependent is enabled)

Moreover, with **Modulation** enabled, the desired leaving water temperature is lowered or raised in function of the desired room temperature and the difference between the actual and the desired room temperature. This results in:

- stable room temperatures, exactly matching the desired temperature (higher comfort level)
- less on/off cycles (lower noise level, higher comfort and higher efficiency)
- water temperatures as low as possible to match the desired temperature (higher efficiency)

If **Modulation** is disabled, set the desired leaving water temperature via [2] **Main zone**.

#	Code	Description
[2.C.1]	[8-05]	Modulation: <ul style="list-style-type: none"> ▪ 0 No (disabled) ▪ 1 Yes (enabled) Note: The desired leaving water temperature can only be read out on the user interface.
[2.C.2]	[8-06]	Max modulation: <ul style="list-style-type: none"> ▪ 0°C~10°C This is the temperature value by which the desired leaving water temperature is increased or decreased.



INFORMATION

When leaving water temperature modulation is enabled, the weather-dependent curve needs to be set to a higher position than [8-06] plus the minimum leaving water temperature setpoint required to reach a stable condition on the comfort setpoint for the room. To increase efficiency, modulation can lower the leaving water setpoint. By setting the weather-dependent curve to a higher position, it cannot drop below the minimum setpoint. See the illustration below.

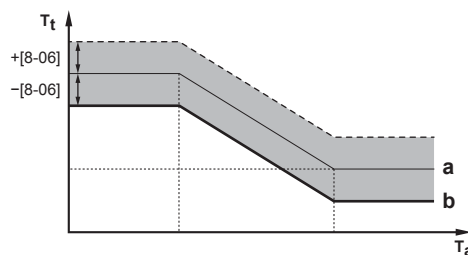

- a** Weather-dependent curve
- b** Minimum leaving water temperature setpoint required to reach a stable condition on the comfort setpoint for the room.

Shut off valve

The following is only applicable in case of 2 leaving water temperature zones. In case of 1 leaving water temperature zone, connect the shut-off valve to the heating/cooling output.

The shut off valve for the main leaving water temperature zone can close under these circumstances:

**INFORMATION**

During defrost operation, the shut-off valve is ALWAYS opened.

During thermo: If [F-OB] is enabled, the shut off valve closes when there is no heating demand from the main zone. Enable this setting to:

- avoid leaving water supply to the heat emitters in the main LWT zone (through the mixing valve station) when there is request from the additional LWT zone.
- activate the ON/OFF pump of the mixing valve station ONLY when there is demand.

#	Code	Description
[2.D.1]	[F-OB]	The shut off valve: <ul style="list-style-type: none"> ▪ 0 No: is NOT influenced by heating or cooling demand. ▪ 1 Yes: closes when there is NO heating or cooling demand.

**INFORMATION**

The setting [F-OB] is only valid when there is a thermostat or external room thermostat request setting (NOT in case of leaving water temperature setting).

During cooling: If [F-OB] is enabled, the shut off valve closes when the unit is running in cooling operation mode. Enable this setting to avoid cold leaving water through the heat emitter and the forming of condensation (e.g. under floor heating loops or radiators).

#	Code	Description
[2.D.2]	[F-OC]	The shut off valve: <ul style="list-style-type: none"> ▪ 0 No: is NOT influenced by changing the space operation mode to cooling. ▪ 1 Yes: closes when the space operation mode is cooling.

WD curve type

The weather dependent curve can be defined using the **2-points** method or the **Slope-Offset** method.

See "[2-points curve](#)" [▶ 130] and "[Slope-offset curve](#)" [▶ 131].

#	Code	Description
[2.E]	N/A	<ul style="list-style-type: none"> ▪ 2-points ▪ Slope-Offset

9.5.4 Additional zone

Overview

The following items are listed in the submenu:

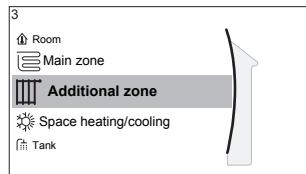

[3] Additional zone

- [3] Setpoint screen
 - [3.1] Schedule
 - [3.2] Heating schedule
 - [3.3] Cooling schedule
 - [3.4] Setpoint mode
 - [3.5] Heating WD curve
 - [3.6] Cooling WD curve
 - [3.7] Emitter type
 - [3.8] Setpoint range
 - [3.9] Control
 - [3.A] Thermostat type
 - [3.B] Delta T
 - [3.C] WD curve type

Setpoint screen

Control the leaving water temperature for the additional zone via setpoint screen [3] **Additional zone**.

See "[Setpoint screen](#)" [▶ 124].

Schedule

Indicates if the desired leaving water temperature is according to a schedule.

See "[Main zone](#)" [▶ 139].

#	Code	Description
[3.1]	N/A	Schedule: <ul style="list-style-type: none"> ▪ No ▪ Yes

Heating schedule

Define a heating temperature schedule for the additional zone via [3.2] **Heating schedule**.

See "[Schedule screen: Example](#)" [▶ 125].

Cooling schedule

Define a cooling temperature schedule for the additional zone via [3.3] **Cooling schedule**.

See "[Schedule screen: Example](#)" [▶ 125].

Setpoint mode

The setpoint mode of the additional zone can be independently set from the setpoint mode of the main zone.

See "[Setpoint mode](#)" [▶ 141].

#	Code	Description
[3.4]	N/A	Setpoint mode: <ul style="list-style-type: none"> ▪ Fixed ▪ WD heating, fixed cooling ▪ Weather dependent

WD curve type

The weather dependent curve can be defined using the **2-points** method or the **Slope-Offset** method.

Also see "[2-points curve](#)" [▶ 130] and "[Slope-offset curve](#)" [▶ 131].

The curve type in the menu of the additional zone is read only. It corresponds to the curve type that is in use for the main zone. Thus, changing the curve type for the additional zone must be done in the menu of the main zone: [2.E] **WD curve type**.

Also see "[Main zone](#)" [▶ 139].

#	Code	Description
[2.E]	N/A	<ul style="list-style-type: none"> ▪ 2-points ▪ Slope-Offset

Heating WD curve

Set weather-dependent heating for the additional zone (if [3.4]=1 or 2):

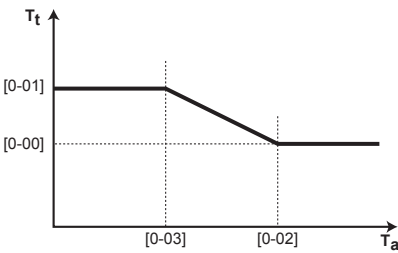
#	Code	Description
[3.5]	[0-00] [0-01] [0-02] [0-03]	<p>Set weather-dependent heating:</p>  <ul style="list-style-type: none"> ▪ T_t: Target leaving water temperature (additional zone) ▪ T_a: Outdoor temperature ▪ [0-03]: Low outdoor ambient temperature. $-40^{\circ}\text{C}\sim+5^{\circ}\text{C}$ ▪ [0-02]: High outdoor ambient temperature. $10^{\circ}\text{C}\sim25^{\circ}\text{C}$ ▪ [0-01]: Desired leaving water temperature when the outdoor temperature equals or drops below the low ambient temperature. $[9-05]^{\circ}\text{C}\sim[9-06]^{\circ}\text{C}$ <p>Note: This value should be higher than [0-00] as for low outdoor temperatures warmer water is required.</p> <ul style="list-style-type: none"> ▪ [0-00]: Desired leaving water temperature when the outdoor temperature equals or rises above the high ambient temperature. $[9-05]\sim\min(45, [9-06])^{\circ}\text{C}$ <p>Note: This value should be lower than [0-01] as for high outdoor temperatures less warm water is required.</p>

Cooling WD curve

Set weather-dependent cooling for the additional zone (if [3.4]=2):

#	Code	Description
[3.6]	[0-04] [0-05] [0-06] [0-07]	<p>Set weather-dependent cooling:</p> <ul style="list-style-type: none"> ▪ T_t: Target leaving water temperature (additional zone) ▪ T_a: Outdoor temperature ▪ [0-07]: Low outdoor ambient temperature. 10°C~25°C ▪ [0-06]: High outdoor ambient temperature. 25°C~43°C ▪ [0-05]: Desired leaving water temperature when the outdoor temperature equals or drops below the low ambient temperature. [9-07]°C~[9-08]°C <p>Note: This value should be higher than [0-04] as for low outdoor temperatures less cold water is required.</p> <ul style="list-style-type: none"> ▪ [0-04]: Desired leaving water temperature when the outdoor temperature equals or rises above the high ambient temperature. [9-07]°C~[9-08]°C <p>Note: This value should be lower than [0-05] as for high outdoor temperatures colder water is required.</p>

Emitter type

For more information about **Emitter type**, see "[Main zone](#)" [▶ 139].

#	Code	Description
[3.7]	[2-0D]	<p>Emitter type:</p> <ul style="list-style-type: none"> ▪ 0: Underfloor heating ▪ 1: Fancoil unit ▪ 2: Radiator

The setting of the emitter type has an influence on the space heating setpoint range and the target delta T in heating as follows:

Emitter type Additional zone	Space heating setpoint range [9-05]~[9-06]	Target delta T in heating [1-0C]
0: Underfloor heating	Maximum 55°C	Variable (see [3.B.1])
1: Fancoil unit	Maximum 55°C	Variable (see [3.B.1])
2: Radiator	Maximum 70°C	Fixed 10°C

Setpoint range

For more information about **Setpoint range**, see "[Main zone](#)" [▶ 139].

#	Code	Description
		Leaving water temperature range for the additional leaving water temperature zone (= the leaving water temperature zone with the highest leaving water temperature in heating operation and the lowest leaving water temperature in cooling operation)
[3.8.1]	[9-05]	Heating minimum: 15°C~37°C
[3.8.2]	[9-06]	Heating maximum <ul style="list-style-type: none"> ▪ [2-0D]=2 (emitter type additional zone = radiator) 37°C~70°C ▪ Else: 37°C~55°C
[3.8.3]	[9-07]	Cooling minimum <ul style="list-style-type: none"> ▪ 5°C~18°C
[3.8.4]	[9-08]	Cooling maximum <ul style="list-style-type: none"> ▪ 18°C~22°C

Control

The control type for the additional zone is read only. It is determined by the control type of the main zone.

See "[Main zone](#)" [▶ 139].

#	Code	Description
[3.9]	N/A	Control: <ul style="list-style-type: none"> ▪ Leaving water if the control type of the main zone is Leaving water. ▪ External room thermostat if the control type of the main zone is: <ul style="list-style-type: none"> - External room thermostat,or - Room thermostat.

Thermostat type

Only applicable in external room thermostat control.

Also see "[Main zone](#)" [▶ 139].

#	Code	Description
[3.A]	[C-06]	External room thermostat type for the additional zone: <ul style="list-style-type: none"> ▪ 1: 1 contact. Connected to only 1 digital input (X2M/35a) ▪ 2: 2 contacts. Connected to 2 digital inputs (X2M/34a and X2M/35a)

Leaving water temperature: Delta T

For more information, see "[Main zone](#)" [▶ 139].

#	Code	Description
[3.B.1]	[1-0C]	Delta T heating: A minimum temperature difference is required for the good operation of heat emitters in heating mode. <ul style="list-style-type: none"> If [2-0D] = 2, this is fixed to 10°C Else: 3°C~10°C
[3.B.2]	[1-0E]	Delta T cooling: A minimum temperature difference is required for the good operation of heat emitters in cooling mode. <ul style="list-style-type: none"> 3°C~10°C

9.5.5 Space heating/cooling

Overview

The following items are listed in the submenu:

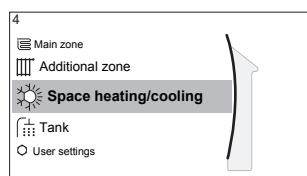

[4] Space heating/cooling

- [4.1] Operation mode
- [4.2] Operation mode schedule
- [4.3] Operation range
- [4.4] Number of zones
- [4.5] Pump operation mode
- [4.6] Unit type
- [4.7] Pump limitation
- [4.8] Pump limitation
- [4.9] Pump outside range
- [4.A] Increase around 0°C
- [4.B] Overshoot
- [4.C] Antifrost

About space operation modes

Your unit can be a heating or a heating/cooling model:

- If your unit is a heating model, it can heat up a space.
- If your unit is a heating/cooling model, it can both heat up and cool down a space. You have to tell the system which operation mode to use.

To determine if a heating/cooling heat pump model is installed

1	Go to [4]: Space heating/cooling.	
2	Check if [4.1] Operation mode is listed and editable. If so, a heating/cooling heat pump model is installed.	

To tell the system which space operation to use, you can:

You can...	Location
Check which space operation mode is currently used.	Home screen

You can...	Location
Set the space operation mode permanently.	Main menu
Restrict automatic changeover according to a monthly schedule.	

To check which space operation mode is currently used



The space operation mode is displayed on the home screen:

- When the unit is in heating mode, the ☀ icon is shown.
- When the unit is in cooling mode, the ❄ icon is shown.

The status indicator shows if the unit is currently in operation:

- When the unit is not in operation, the status indicator will show a blue pulsation with an interval of approximately 5 seconds.
- While the unit is in operation, the status indicator will light up blue constantly.

To set the space operation mode

1	Go to [4.1]: Space heating/cooling > Operation mode	
2	Select one of the following options: <ul style="list-style-type: none"> ▪ Heating: Only heating mode ▪ Cooling: Only cooling mode ▪ Automatic: The operation mode changes automatically between heating and cooling based on the outdoor temperature. Restricted per month according to the Operation mode schedule [4.2]. 	





Automatic heating/cooling changeover is only applicable for:

- Reversible models
- Heating only models + conversion kit (EKHVCONV2)

When **Automatic** is selected, the unit switches its operation mode, based on the **Operation mode schedule** [4.2]. In this schedule, the end user indicates which operation is allowed for each month.

To restrict automatic changeover according to a schedule

Conditions: You set the space operation mode to **Automatic**.

1	Go to [4.2]: Space heating/cooling > Operation mode schedule .	
2	Select a month.	
3	For each month, select an option: <ul style="list-style-type: none"> ▪ Reversible: Not restricted ▪ Heating only: Restricted ▪ Cooling only: Restricted 	
4	Confirm the changes.	

Example: Changeover restrictions

When	Restriction
During cold season. Example: October, November, December, January, February and March.	Heating only
During warm season. Example: June, July and August.	Cooling only
In-between. Example: April, May and September.	Reversible

The unit determines its operation mode by the outdoor temperature if:

- **Operation mode=Automatic**, and
- **Operation mode schedule=Reversible**.

The unit determines its operation mode in such a way that it will always stay within the following operation ranges:

- **Space heating off temperature**
- **Space cooling off temperature**

The outdoor temperature is time-averaged. If the outdoor temperature drops, the operation mode will switch to heating and vice versa.

If the outdoor temperature is between the **Space heating off temperature** and the **Space cooling off temperature**, the operation mode remains unchanged.

Operation range

Depending on the average outdoor temperature, the operation of the unit in space heating or space cooling is prohibited.

#	Code	Description
[4.3.1]	[4-02]	Space heating off temperature: When the averaged outdoor temperature rises above this value, space heating is turned off. ^(a) ▪ 14°C~35°C
[4.3.2]	[F-01]	Space cooling off temperature: When the averaged outdoor temperature drops below this value, space cooling is turned off. ^(a) ▪ 10°C~35°C

^(a) This setting is also used in automatic heating/cooling changeover.

Exception: If the system is configured in room thermostat control with one leaving water temperature zone and quick heat emitters, the operation mode will change based on the measured indoor temperature. Besides the desired heating/cooling room temperature, the installer sets a hysteresis value (e.g. when in heating, this value is related to the desired cooling temperature) and an offset value (e.g. when in heating, this value is related to the desired heating temperature).

Example: A unit is configured as following:

- Desired room temperature in heating mode: 22°C
- Desired room temperature in cooling mode: 24°C
- Hysteresis value: 1°C

- Offset: 4°C

Changeover from heating to cooling will occur when the room temperature rises above the maximum of the desired cooling temperature added by the hysteresis value (thus 24+1=25°C) and the desired heating temperature added by the offset value (thus 22+4=26°C).

Oppositely, changeover from cooling to heating will occur when the room temperature drops below the minimum of the desired heating temperature subtracted by the hysteresis value (thus 22-1=21°C) and the desired cooling temperature subtracted by the offset value (thus 24-4=20°C)

Guard timer to prevent too frequent changing from heating to cooling and vice versa.

#	Code	Description
Changeover settings related to the indoor temperature. Only applicable when Automatic is selected and the system is configured in room thermostat control with 1 leaving water temperature zone and quick heat emitters.		
N/A	[4-0B]	Hysteresis: ensures that changeover is only done when necessary. The space operation only changes from heating to cooling when the room temperature rises above the desired cooling temperature added by the hysteresis value. ▪ Range: 1°C~10°C
N/A	[4-0D]	Offset: ensures that the active desired room temperature is always reached. In heating mode, the space operation only changes when the room temperature rises above the desired heating temperature added by the offset value. ▪ Range: 1°C~10°C

Number of zones

The system can supply leaving water to up to 2 water temperature zones. During configuration, the number of water zones must be set.



INFORMATION

Mixing station. If your system layout contains 2 LWT zones, you need to install a mixing station in front of the main LWT zone.

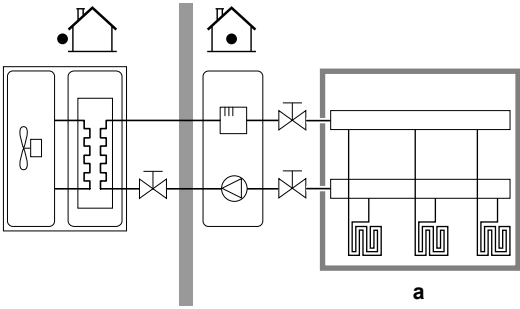
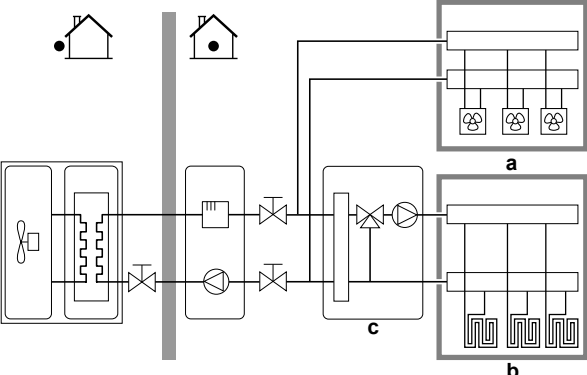
#	Code	Description
[4.4]	[7-02]	<ul style="list-style-type: none"> 0: Single zone <p>Only one leaving water temperature zone:</p>  <p>a Main LWT zone</p>
[4.4]	[7-02]	<ul style="list-style-type: none"> 1: Dual zone <p>Two leaving water temperature zones. The main leaving water temperature zone consists of the higher load heat emitters and a mixing station to achieve the desired leaving water temperature. In heating:</p>  <p>a Additional LWT zone: Highest temperature b Main LWT zone: Lowest temperature c Mixing station</p>

**NOTICE**

NOT configuring the system in the following way can cause damage to the heat emitters. If there are 2 zones, it is important that in heating:

- the zone with the lowest water temperature is configured as the main zone, and
- the zone with the highest water temperature is configured as the additional zone.

**NOTICE**

If there are 2 zones and the emitter types are wrongly configured, water of high temperature can be sent towards a low temperature emitter (underfloor heating). To avoid this:

- Install an aquastat/thermostatic valve to avoid too high temperatures towards a low temperature emitter.
- Make sure you set the emitter types for the main zone [2.7] and for the additional zone [3.7] correctly in accordance with the connected emitter.

Pump operation mode

When the space heating/cooling operation is OFF, the pump is always OFF. When space heating/cooling operation is ON, you have the choice between these operation modes:

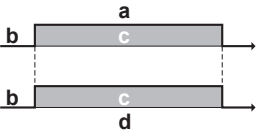
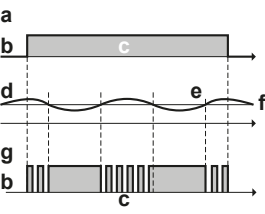
#	Code	Description
[4.5]	[F-0D]	<p>Pump operation mode:</p> <ul style="list-style-type: none"> 0 Continuous: Continuous pump operation, regardless of thermo ON or OFF condition. Remark: Continuous pump operation requires more energy than sample or request pump operation.  <p>a Space heating/cooling control b Off c On d Pump operation</p>
[4.5]	[F-0D]	<ul style="list-style-type: none"> 1 Sample: The pump is ON when there is heating or cooling demand as the leaving water temperature has not yet reached the desired temperature yet. When thermo OFF condition occurs, the pump runs every 3 minutes to check the water temperature and demand heating or cooling if necessary. Remark: Sample is ONLY available in leaving water temperature control.  <p>a Space heating/cooling control b Off c On d LWT temperature e Actual f Desired g Pump operation</p>

#	Code	Description
[4.5]	[F-0D]	<ul style="list-style-type: none"> ▪ 2 Request: Pump operation based on request. <p>Example: Using a room thermostat and thermostat creates thermo ON/OFF condition.</p> <p>Remark: NOT available in leaving water temperature control.</p> <p>The diagram shows five horizontal bars representing different states over time. Bar 'a' is a long bar with a dashed line at its end. Bar 'b' is a shorter bar starting at the same time as 'a'. Bar 'c' is a bar that starts after 'b' and ends before 'a' ends. Bar 'd' consists of two separate bars, one starting after 'c' and one starting after 'a' ends. Bar 'e' consists of two separate bars, one starting after 'c' and one starting after 'a' ends.</p> <p>a Space heating/cooling control b Off c On d Heating demand (by external room thermostat or room thermostat) e Pump operation</p>

Unit type

In this part of the menu it can be read out which type of unit is used:

#	Code	Description
[4.6]	[E-02]	<p>Unit type:</p> <ul style="list-style-type: none"> ▪ 0 Reversible ▪ 1 Heating only

Pump limitation

Pump speed limitation [9-0D] defines the maximum pump speed. In normal conditions, the default setting should NOT be modified. The pump speed limitation will be overruled when the flow rate is in the range of the minimum flow (error 7H).

#	Code	Description
[4.7]	[9-0D]	<p>Pump limitation:</p> <ul style="list-style-type: none"> ▪ 0: No limitation ▪ 1~4: General limitation. There is limitation in all conditions. The required delta T control and comfort are NOT guaranteed. ▪ 5~8: Limitation when no actuators. When there is no heating output, the pump speed limitation is applicable. When there is heating output, the pump speed is only determined by delta T in relation to the required capacity. With this limitation range, delta T is possible and the comfort is guaranteed.

The maximum values depend on the unit type:

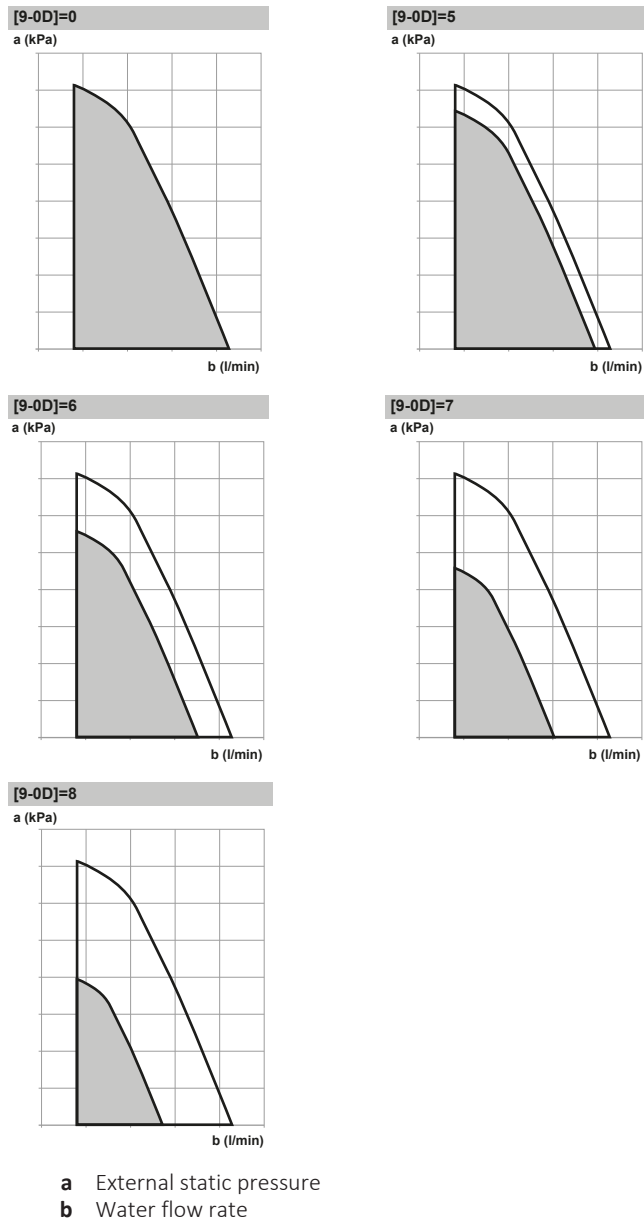

Pump outside range

When the pump operation function is disabled the pump will stop if the outdoor temperature is higher than the value set by the **Space heating off temperature** [4-02] or if the outdoor temperature drops below the value set by the **Space cooling off temperature** [F-01]. When the pump operation is enabled, the pump operation is possible at all outdoor temperatures.

#	Code	Description
[4.9]	[F-00]	Pump operation: <ul style="list-style-type: none"> 0: Disabled if outdoor temperature is higher than [4-02] or lower than [F-01] depending on heating/cooling operation mode. 1: Possible at all outdoor temperatures.

Increase around 0°C

Use this setting to compensate for possible heat losses of the building due to the evaporation of melted ice or snow. (e.g. in cold region countries).

In heating operation, the desired leaving water temperature is locally increased around an outdoor temperature of 0°C. This compensation can be selected when using an absolute or a weather dependent desired temperature (see illustration below).

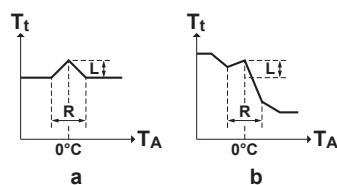

a Absolute desired LWT
b Weather dependent desired LWT

#	Code	Description
[4.A]	[D-03]	Increase around 0°C: <ul style="list-style-type: none"> ▪ 0: No ▪ 1: increase 2°C, span 4°C ▪ 2: increase 4°C, span 4°C ▪ 3: increase 2°C, span 8°C ▪ 4: increase 4°C, span 8°C

Overshoot

Restriction: This function is only applicable in heating mode.

This function defines how much the water temperature may rise above the desired leaving water temperature before the compressor stops. The compressor will start up again when the leaving water temperature drops below the desired leaving water temperature.

#	Code	Description
[4.B]	[9-04]	Overshoot: <ul style="list-style-type: none"> ▪ 1°C~4°C

Antifrost

Room frost protection [1.4] prevents the room from getting too cold. For more information about room frost protection, see "[Room](#)" [▶ 135].

9.5.6 Tank

Overview

The following items are listed in the submenu:

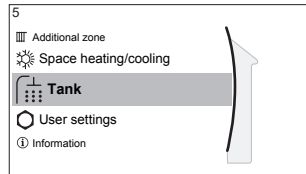

[5] Tank

[5] Setpoint screen

[5.1] Powerful operation

[5.2] Comfort setpoint

[5.3] Eco setpoint

[5.4] Reheat setpoint

[5.5] Schedule

[5.6] Heat up mode

[5.7] Disinfection

[5.8] Maximum

[5.9] Hysteresis

[5.A] Hysteresis

[5.B] Setpoint mode

[5.C] WD curve

[5.D] Margin



INFORMATION

To make tank defrost possible, we recommend a minimum tank temperature of 35°C.

Tank setpoint screen



You can set the domestic hot water temperature using the setpoint screen. For more information about how to do this, see "[Setpoint screen](#)" [▶ 124].

Powerful operation

You can use powerful operation to immediately start heating up the water to the preset value (Storage comfort). However, this consumes extra energy. If powerful operation is active,  will be shown on the home screen.

To activate powerful operation

Activate or deactivate **Powerful operation** as follows:

1	Go to [5.1]: Tank > Powerful operation	
2	Turn powerful operation Off or On .	

Usage example: You immediately need more hot water

If you are in the following situation:

- You already consumed most of your hot water.
- You cannot wait for the next scheduled action to heat up the DHW tank.

Then you can activate DHW powerful operation.

Advantage: The DHW tank immediately starts heating up the water to the preset value (Storage comfort).



INFORMATION

When powerful operation is active, the risk of space heating/cooling and capacity shortage comfort problems is significant. In case of frequent domestic hot water operation, frequent and long space heating/cooling interruptions will happen.

Comfort setpoint

Only applicable when domestic hot water preparation is **Schedule only** or **Schedule + reheat**. When programming the schedule, you can make use of the comfort setpoint as a preset value. When you later want to change the storage setpoint, you only have to do it in one place.

The tank will heat up until the **storage comfort temperature** has been reached. It is the higher desired temperature when a storage comfort action is scheduled.

Additionally, a storage stop can be programmed. This feature puts a stop to tank heating even if the setpoint has NOT been reached. Only program a storage stop when tank heating is absolutely undesirable.

#	Code	Description
[5.2]	[6-0A]	Comfort setpoint: ▪ 30°C~[6-0E]°C

Eco setpoint

The **storage economic temperature** denotes the lower desired tank temperature. It is the desired temperature when a storage economic action is scheduled (preferably during day).

#	Code	Description
[5.3]	[6-0B]	Eco setpoint: ▪ 30°C~min(50,[6-0E])°C

Reheat setpoint

Desired reheat tank temperature, used:

- in **Schedule + reheat** mode, during reheat mode: the guaranteed minimum tank temperature is set by the **Reheat setpoint** minus the reheat hysteresis. If the tank temperature drops below this value, the tank is heated up.
- during storage comfort, to prioritize the domestic hot water preparation. When the tank temperature rises above this value, domestic hot water preparation and space heating/cooling are executed sequentially.

#	Code	Description
[5.4]	[6-0C]	Reheat setpoint: ▪ 30°C~min(50,[6-0E])°C

Schedule

You can set the tank temperature schedule using the schedule screen. For more information about this screen, see "[Schedule screen: Example](#)" [▶ 125].

Heat up mode

The domestic hot water can be prepared in 3 different ways. They differ from each other by the way the desired tank temperature is set and how the unit acts upon it.

#	Code	Description
[5.6]	[6-0D]	Heat up mode: <ul style="list-style-type: none"> ▪ 0: Reheat only: Only reheat operation is allowed. ▪ 1: Schedule + reheat: The domestic hot water tank is heated according to a schedule and between the scheduled heat up cycles, reheat operation is allowed. ▪ 2: Schedule only: The domestic hot water tank can ONLY be heated according to a schedule.

See the operation manual for more details.

Disinfection

Applies only to installations with a domestic hot water tank.

The disinfection function disinfects the domestic hot water tank by periodically heating the domestic hot water to a specific temperature.



CAUTION

The disinfection function settings MUST be configured by the installer according to the applicable legislation.

#	Code	Description
[5.7.1]	[2-01]	Activation: <ul style="list-style-type: none"> ▪ 0: No ▪ 1: Yes
[5.7.2]	[2-00]	Operation day: <ul style="list-style-type: none"> ▪ 0: Every day ▪ 1: Monday ▪ 2: Tuesday ▪ 3: Wednesday ▪ 4: Thursday ▪ 5: Friday ▪ 6: Saturday ▪ 7: Sunday
[5.7.3]	[2-02]	Start time
[5.7.4]	[2-03]	Tank setpoint: 60°C
[5.7.5]	[2-04]	Duration: 40~60 minutes

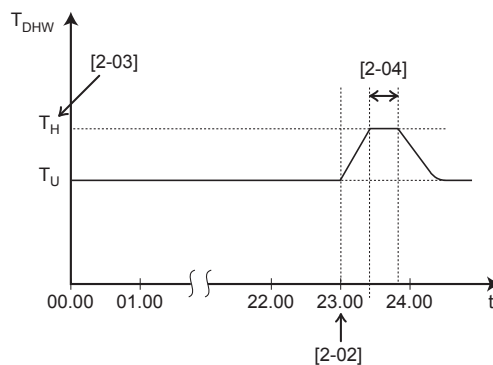

T_{DHW} Domestic hot water temperature
 T_U User setpoint temperature
 T_H High setpoint temperature [2-03]
 t Time



WARNING

Be aware that the domestic hot water temperature at the hot water tap will be equal to the value selected in field setting [2-03] after a disinfection operation.

When the high domestic hot water temperature can be a potential risk for human injuries, a mixing valve (field supply) shall be installed at the hot water outlet connection of the domestic hot water tank. This mixing valve shall secure that the hot water temperature at the hot water tap never rise above a set maximum value. This maximum allowable hot water temperature shall be selected according to the applicable legislation.



CAUTION

Be sure that the disinfection function start time [5.7.3] with defined duration [5.7.5] is NOT interrupted by possible domestic hot water demand.



NOTICE

Disinfection mode. Even if you turn OFF tank heating operation ([C.3]: **Operation** > **Tank**), disinfection mode will remain active. However, if you turn it OFF while disinfection is running, an AH error occurs.



INFORMATION

In case of error code AH and no interruption of the disinfection function occurred due to domestic hot water tapping, following actions are recommended:

- When the **Reheat only** or **Schedule + reheat** mode is selected, it is recommended to program the start-up of the disinfection function at least 4 hours later than the last expected large hot water tapping. This start-up can be set by installer settings (disinfection function).
- When the **Schedule only** mode is selected, it is recommended to program an **Eco** action 3 hours before the scheduled start-up of the disinfection function to preheat the tank.



INFORMATION

Disinfection function is restarted in case the domestic hot water temperature drops 5°C below the disinfection target temperature within the duration time.

Maximum DHW temperature setpoint

The maximum temperature that users can select for the domestic hot water. You can use this setting to limit the temperatures at the hot water taps.

**INFORMATION**

During disinfection of the domestic hot water tank, the DHW temperature can exceed this maximum temperature.

**INFORMATION**

Limit the maximum hot water temperature according to the applicable legislation.

#	Code	Description
[5.8]	[6-0E]	<p>Maximum:</p> <p>The maximum temperature that users can select for the domestic hot water. You can use this setting to limit the temperature at the hot water taps.</p> <p>The maximum temperature is NOT applicable during disinfection function. See disinfection function.</p>

Hysteresis

The following ON hysteresis can be set.

Heat pump ON hysteresis

Applicable when domestic hot water preparation is reheat only. When the tank temperature drops below the reheat temperature minus the heat pump ON hysteresis temperature, the tank heats up to the reheat temperature.

The minimum ON temperature is 20°C, even if setpoint hysteresis is smaller than 20°C.

#	Code	Description
[5.9]	[6-00]	<p>Heat pump ON hysteresis</p> <ul style="list-style-type: none"> 2°C~40°C

Reheat hysteresis

Applicable when domestic hot water preparation is scheduled+reheat. When the tank temperature drops below the reheat temperature minus the reheat hysteresis temperature, the tank heats up to the reheat temperature.

#	Code	Description
[5.A]	[6-08]	<p>Reheat hysteresis</p> <ul style="list-style-type: none"> 2°C~20°C

Setpoint mode

#	Code	Description
[5.B]	N/A	<p>Setpoint mode:</p> <ul style="list-style-type: none"> Fixed Weather dependent

WD curve

When weather dependent operation is active the desired tank temperature is determined automatically depending on the averaged outdoor temperature: low outdoor temperatures will result in higher desired tank temperatures as the cold water tap is colder and vice versa.

In case of **Schedule only** or **Schedule + reheat** domestic hot water preparation, the storage comfort temperature is weather dependent (according to the weather dependent curve), the storage economic and reheat temperature are NOT weather dependent.

In case of **Reheat only** domestic hot water preparation, the desired tank temperature is weather dependent (according to the weather dependent curve). During weather dependent operation, the end-user cannot adjust the desired tank temperature on the user interface. Also see "9.4 Weather-dependent curve" [▶ 130].

#	Code	Description
[5.C]	[0-0E] [0-0D] [0-0C] [0-0B]	<p>WD curve:</p> <ul style="list-style-type: none"> ▪ T_{DHW}: The desired tank temperature. ▪ T_a: The (averaged) outdoor ambient temperature ▪ [0-0E]: low outdoor ambient temperature: $-40^{\circ}\text{C}\sim 5^{\circ}\text{C}$ ▪ [0-0D]: high outdoor ambient temperature: $10^{\circ}\text{C}\sim 25^{\circ}\text{C}$ ▪ [0-0C]: desired tank temperature when the outdoor temperature equals or drops below the low ambient temperature: $45^{\circ}\text{C}\sim [6-0E]^{\circ}\text{C}$ ▪ [0-0B]: desired tank temperature when the outdoor temperature equals or rises above the high ambient temperature: $35^{\circ}\text{C}\sim [6-0E]^{\circ}\text{C}$

Margin

In domestic hot water operation, the following hysteresis value can be set for the heat pump operation:

#	Code	Description
[5.D]	[6-01]	The temperature difference determining the heat pump OFF temperature. Range: $0^{\circ}\text{C}\sim 10^{\circ}\text{C}$

Example: setpoint (T_U) > maximum heat pump temperature - [6-01] ($T_{HP\ MAX} - [6-01]$)

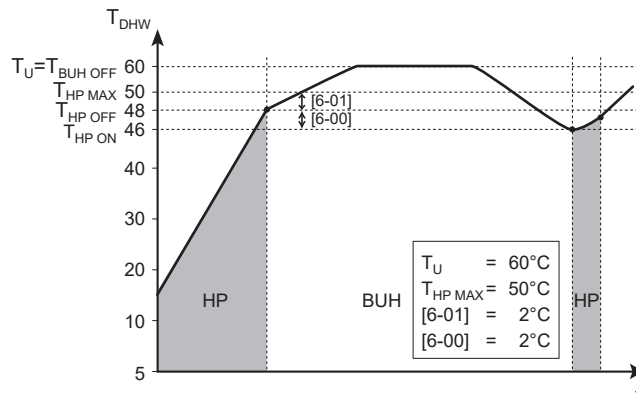

- BUH** Backup heater
- HP** Heat pump. If heating up time by the heat pump takes too long, auxiliary heating by the backup heater can take place
- T_{BUH OFF}** Backup heater OFF temperature (T_U)
- T_{HP MAX}** Maximum heat pump temperature at sensor in domestic hot water tank
- T_{HP OFF}** Heat pump OFF temperature (T_{HP MAX}-[6-01])
- T_{HP ON}** Heat pump ON temperature (T_{HP OFF}-[6-00])
- T_{DHW}** Domestic hot water temperature
- T_U** User setpoint temperature (as set on the user interface)
- t** Time

Example: setpoint (T_U) ≤ maximum heat pump temperature-[6-01] (T_{HP MAX}-[6-01])

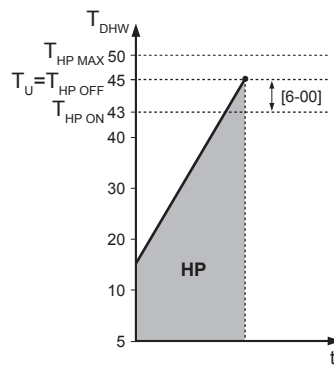

- HP** Heat pump. If heating up time by the heat pump takes too long, auxiliary heating by the backup heater can take place
- T_{HP MAX}** Maximum heat pump temperature at sensor in domestic hot water tank
- T_{HP OFF}** Heat pump OFF temperature (T_{HP MAX}-[6-01])
- T_{HP ON}** Heat pump ON temperature (T_{HP OFF}-[6-00])
- T_{DHW}** Domestic hot water temperature
- T_U** User setpoint temperature (as set on the user interface)
- t** Time



INFORMATION

The maximum heat pump temperature depends on the ambient temperature. For more information, see the operation range.

9.5.7 User settings

Overview

The following items are listed in the submenu:

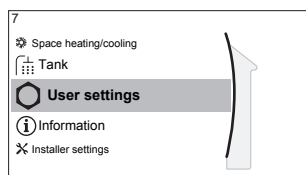

[7] User settings

- [7.1] Language
- [7.2] Time/date
- [7.3] Holiday
- [7.4] Quiet
- [7.5] Electricity price
- [7.6] Gas price

Language

#	Code	Description
[7.1]	N/A	Language

Time/date

#	Code	Description
[7.2]	N/A	Set the local time and date



INFORMATION

By default, daylight savings time is enabled and clock format is set to 24 hours. If you want to change these settings, you can do this in the menu structure (**User settings > Time/date**) once the unit is initialised.

Holiday

About holiday mode

During your holiday, you can use the holiday mode to deviate from your normal schedules without having to change them. While holiday mode is active, space heating/cooling operation and domestic hot water operation will be turned off. Room frost protection and anti-legionella operation will remain active.

Typical workflow

Using holiday mode typically consists of the following stages:

- 1 Setting the starting date and ending date of your holiday.
- 2 Activating the holiday mode.

To check if holiday mode is activated and/or running

If is displayed on the home screen, holiday mode is active.

To configure the holiday

1	Activate the holiday mode.	—
	<ul style="list-style-type: none"> ▪ Go to [7.3.1]: User settings > Holiday > Activation. <div style="border: 1px solid black; padding: 5px; margin: 5px 0;"> <p>7.3.1</p> <p>Activation</p> <p>From</p> <p>Till</p> </div>	
	<ul style="list-style-type: none"> ▪ Select On. 	

2	Set the first day of your holiday.	—
	▪ Go to [7.3.2]: From .	
	▪ Select a date.	
	▪ Confirm the changes.	
3	Set the last day of your holiday.	—
	▪ Go to [7.3.3]: Till .	
	▪ Select a date.	
	▪ Confirm the changes.	

Quiet

About quiet mode

You can use quiet mode to decrease the sound of the outdoor unit. However, this also decreases the heating/cooling capacity of the system. There are multiple quiet mode levels.

The installer can:

- Completely deactivate quiet mode
- Manually activate a quiet mode level
- Enable the user to program a quiet mode schedule

If enabled by the installer, the user can program a quiet mode schedule.

INFORMATION
 If the outdoor temperature is below zero, we recommend to NOT use the most quiet level.

To check if quiet mode is active

If is displayed on the home screen, quiet mode is active.

To use quiet mode

1	Go to [7.4.1]: User settings > Quiet > Activation .	
2	Do one of the following:	—

If you want to...	Then...	
Completely deactivate quiet mode	Select Off . Result: The unit never runs in quiet mode. The user cannot change this.	
Manually activate a quiet mode level	Select Manual .	
	Go to [7.4.3] Level and select the applicable quiet mode level. Example: Most quiet. Result: The unit always runs in the selected quiet mode level. The user cannot change this.	

If you want to...	Then...
Enable the user to program a quiet mode schedule	Select Automatic . Result: The unit runs in quiet mode according to a schedule. The user (or you) can program the schedule in [7.4.2] Schedule . For more information about scheduling, see " Schedule screen: Example " [▶ 125].

Electricity prices and gas price

Only applicable in combination with the bivalent function. See also "[Bivalent](#)" [▶ 189].

#	Code	Description
[7.5.1]	N/A	Electricity price > High
[7.5.2]	N/A	Electricity price > Medium
[7.5.3]	N/A	Electricity price > Low
[7.6]	N/A	Gas price



INFORMATION

Electricity price can only be set when bivalent is ON ([9.C.1] or [C-02]). These values can only be set in menu structure [7.5.1], [7.5.2] and [7.5.3]. Do NOT use overview settings.

To set the gas price

1	Go to [7.6]: User settings > Gas price .	
2	Select the correct gas price.	
3	Confirm the changes.	



INFORMATION

Price value ranging from 0.00~990 valuta/kWh (with 2 significant values).

To set the electricity price

1	Go to [7.5.1]/[7.5.2]/[7.5.3]: User settings > Electricity price > High/Medium/Low .	
2	Select the correct electricity price.	
3	Confirm the changes.	
4	Repeat this for all three electricity prices.	—



INFORMATION

Price value ranging from 0.00~990 valuta/kWh (with 2 significant values).



INFORMATION

If no schedule is set, the **Electricity price** for **High** is taken into account.

To set the electricity price schedule timer

1	Go to [7.5.4]: User settings > Electricity price > Schedule.	
2	Program the selection using the scheduling screen. You can set the High, Medium and Low electricity prices according to your electricity supplier.	—
3	Confirm the changes.	

i

INFORMATION

The values correspond with the electricity price values for **High, Medium** and **Low** previously set. If no schedule is set, the electricity price for **High** is taken into account.

About energy prices in case of an incentive per kWh renewable energy

An incentive can be taken into account when setting the energy prices. Although the running cost can increase, the total operation cost, taking into account the reimbursement will be optimized.

NOTICE

Make sure to modify the setting of the energy prices at the end of the incentive period.

To set the gas price in case of an incentive per kWh renewable energy

Calculate the value for the gas price with the following formula:

- Actual gas price+(Incentive/kWh×0.9)

For the procedure to set the gas price, see ["To set the gas price"](#) [▶ 173].

To set the electricity price in case of an incentive per kWh renewable energy

Calculate the value for the electricity price with following formula:

- Actual electricity price+Incentive/kWh

For the procedure to set the electricity price, see ["To set the electricity price"](#) [▶ 173].

Example

This is an example and the prices and/or values used in this example are NOT accurate.

Data	Price/kWh
Gas price	4.08
Electricity price	12.49
Renewable heat incentive per kWh	5

Calculation of the gas price

Gas price=Actual gas price+(Incentive/kWh×0.9)

Gas price=4.08+(5×0.9)

Gas price=8.58

Calculation of the electricity price

Electricity price=Actual electricity price+Incentive/kWh

Electricity price=12.49+5

Electricity price=17.49

Price	Value in breadcrumb
Gas: 4.08 /kWh	[7.6]=8.6
Electricity: 12.49 /kWh	[7.5.1]=17

9.5.8 Information

Overview

The following items are listed in the submenu:

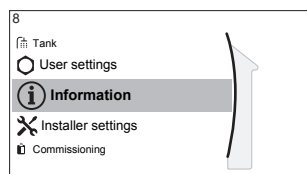

[8] Information

[8.1] Energy data

[8.2] Malfunction history

[8.3] Dealer information

[8.4] Sensors

[8.5] Actuators

[8.6] Operation modes

[8.7] About

[8.8] Connection status

[8.9] Running hours

[8.A] Reset

Dealer information

The installer can fill in his contact number here.

#	Code	Description
[8.3]	N/A	Number that users can call in case of problems.

Reset

Reset the configuration settings stored in the MMI (user interface of the indoor unit).

Example: Energy meterings, holiday settings.



INFORMATION

This does not reset the configuration settings and field settings of the indoor unit.

#	Code	Description
[8.A]	N/A	Reset the MMI EEPROM to factory default

Possible read-out information

In menu...	You can read out...
[8.1] Energy data	Produced energy, consumed electricity, and consumed gas
[8.2] Malfunction history	Malfunction history
[8.3] Dealer information	Contact/helpdesk number

In menu...	You can read out...
[8.4] Sensors	Room, tank or domestic hot water, outside, and leaving water temperature (if applicable)
[8.5] Actuators	Status/mode of each actuator Example: Domestic hot water pump ON/OFF
[8.6] Operation modes	Current operation mode Example: Defrost/oil return mode
[8.7] About	Version information about the system
[8.8] Connection status	Information about the connection status of the unit, the room thermostat and the LAN adapter.
[8.9] Running hours	Running hours of specific system components

9.5.9 Installer settings

Overview

The following items are listed in the submenu:

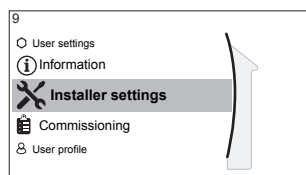

[9] Installer settings

- [9.1] Configuration wizard
- [9.2] Domestic hot water
- [9.3] Backup heater
- [9.5] Emergency
- [9.6] Balancing
- [9.7] Water pipe freeze prevention
- [9.8] Benefit kWh power supply
- [9.9] Power consumption control
- [9.A] Energy metering
- [9.B] Sensors
- [9.C] Bivalent
- [9.D] Alarm output
- [9.E] Auto restart
- [9.F] Power saving function
- [9.G] Disable protections
- [9.H] Forced defrost
- [9.I] Overview field settings
- [9.N] Export MMI settings

Configuration wizard

After first power ON of the system, the user interface will guide you using the configuration wizard. This way you can set the most important initial settings. This way the unit will be able to run properly. Afterwards, more detailed settings can be done via the menu structure if required.

To restart the configuration wizard, go to **Installer settings > Configuration wizard** [9.1].

Domestic hot water

Domestic hot water

The following setting determines if the system can prepare domestic hot water or not, and which tank is used. This setting is read only.

#	Code	Description
[9.2.1]	[E-05] ^(a) [E-06] ^(a) [E-07] ^(a)	<ul style="list-style-type: none"> ▪ Integrated <p>The backup heater will also be used for domestic hot water heating.</p>

^(a) Use the menu structure instead of the overview settings. Menu structure setting [9.2.1] replaces the following 3 overview settings:

- [E-05]: Can the system prepare domestic hot water?
- [E-06]: Is a domestic hot water tank installed in the system?
- [E-07]: What kind of domestic hot water tank is installed?

DHW pump

#	Code	Description
[9.2.2]	[D-02]	<p>DHW pump:</p> <ul style="list-style-type: none"> ▪ 0: No DHW pump: NOT installed ▪ 1: Instant hot water: Installed for instant hot water when water is tapped. The user sets the operation timing of the domestic hot water pump using the schedule. Control of this pump is possible with the user interface. ▪ 2: Disinfection: Installed for disinfection. It runs when the disinfection function of the domestic hot water tank is running. No further settings are needed.

See also:

- ["DHW pump for instant hot water" \[▶ 44\]](#)
- ["DHW pump for disinfection" \[▶ 45\]](#)

DHW pump schedule

Program a schedule for the DHW pump (**only for field supplied domestic hot water pump for secondary return**).

Program a domestic hot water pump schedule to determine when to turn on and off the pump.

When turned on, the pump runs and makes sure hot water is instantly available at the tap. To save energy, only turn on the pump during periods of the day when instant hot water is necessary.

Backup heater

Besides the type of backup heater, the voltage, configuration and capacity must be set on the user interface.

The capacities for the different steps of the backup heater must be set for the energy metering and/or power consumption feature to work properly. When measuring the resistance value of each heater, you can set the exact heater capacity and this will lead to more accurate energy data.

Backup heater type

The backup heater is adapted to be connected to most common European electricity grids. The type of backup heater can be viewed but not changed.

#	Code	Description
[9.3.1]	[E-03]	<ul style="list-style-type: none"> ▪ 3: 6V ▪ 4: 9W

Voltage

- For a 6V model, this can be set to:
 - 230V, 1ph
 - 230V, 3ph
- For a 9W model, this is fixed to 400V, 3ph.

#	Code	Description
[9.3.2]	[5-0D]	<ul style="list-style-type: none"> ▪ 0: 230V, 1ph ▪ 1: 230V, 3ph ▪ 2: 400V, 3ph

Configuration

The backup heater can be configured in different ways. It can be chosen to have a 1-step only backup heater or a backup heater with 2 steps. If 2 steps, the capacity of the second step depends on this setting. It can also be chosen to have a higher capacity of the second step in emergency.

#	Code	Description
[9.3.3]	[4-0A]	<ul style="list-style-type: none"> ▪ 0: Relay 1 ▪ 1: Relay 1 / Relay 1+2 ▪ 2: Relay 1 / Relay 2 ▪ 3: Relay 1 / Relay 2 Emergency Relay 1+2



INFORMATION

Settings [9.3.3] and [9.3.5] are linked. Changing one setting influences the other. If you change one, check if the other is still as expected.



INFORMATION

During normal operation, the capacity of the second step of the backup heater at nominal voltage is equal to [6-03]+[6-04].



INFORMATION

If [4-0A]=3 and emergency mode is active, the power usage of the backup heater is maximal and equal to $2 \times [6-03] + [6-04]$.

**INFORMATION**

Only for systems with integrated domestic hot water tank: If the storage temperature setpoint is higher than 50°C, Daikin recommends NOT to disable the backup heater second step because it will have a big impact on the required time for the unit to heat up the domestic hot water tank.

Capacity step 1

#	Code	Description
[9.3.4]	[6-03]	<ul style="list-style-type: none"> The capacity of the first step of the backup heater at nominal voltage.

Additional capacity step 2

#	Code	Description
[9.3.5]	[6-04]	<ul style="list-style-type: none"> The capacity difference between the second and first step of the backup heater at nominal voltage. Nominal value depends on backup heater configuration.

Equilibrium

#	Code	Description
[9.3.6]	[5-00]	<p>Equilibrium: Is backup heater operation allowed above equilibrium temperature during space heating operation?</p> <ul style="list-style-type: none"> 1: NOT allowed 0: Allowed
[9.3.7]	[5-01]	<p>Equilibrium temperature: Outdoor temperature below which operation of the backup heater is allowed.</p> <p>Range: -15°C~35°C</p>

**INFORMATION**

Above 10°C ambient temperature, the heat pump will operate until 55°C. Configuring a higher setpoint with an ambient temperature that is higher than the set equilibrium temperature will prevent the backup heater from assisting. The backup heater will ONLY assist if you increase the equilibrium temperature [5-01] to the required ambient temperature you need to reach the higher setpoint.

Operation

#	Code	Description
[9.3.8]	[4-00]	<p>Backup heater operation:</p> <ul style="list-style-type: none"> 0: Restricted 1: Allowed 2: Only DHW: Backup heater operation is enabled for domestic hot water and disabled for space heating.



INFORMATION

Only for systems with integrated domestic hot water tank: If backup heater operation during space heating needs to be limited but can be allowed for domestic hot water operation, then set [4-00] to 2.

Emergency

Emergency

When the heat pump fails to operate, the backup heater can serve as an emergency heater. It then takes over the heat load either automatically or by manual interaction.

- When **Emergency** is set to **Automatic** and a heat pump failure occurs, the backup heater automatically takes over the domestic hot water production and space heating.
- When **Emergency** is set to **Manual** and a heat pump failure occurs, the domestic hot water heating and space heating stops.

To manually recover it via the user interface, go to the **Malfunctioning** main menu screen and confirm whether the backup heater can take over the heat load or not.

- Alternatively, when **Emergency** is set to:
 - **auto SH reduced/DHW on**, space heating is reduced but domestic hot water is still available.
 - **auto SH reduced/DHW off**, space heating is reduced and domestic hot water is NOT available.
 - **auto SH normal/DHW off**, space heating operates as normally but domestic hot water is NOT available.

Similarly as in **Manual** mode, the unit can take the full load with the backup heater if the user activates this via the **Malfunctioning** main menu screen.

To keep energy consumption low, we recommend to set **Emergency** to **auto SH reduced/DHW off** if the house is unattended for longer periods.

#	Code	Description
[9.5.1]	[4-06]	<ul style="list-style-type: none"> ▪ 0: Manual ▪ 1: Automatic ▪ 2: auto SH reduced/DHW on ▪ 3: auto SH reduced/DHW off ▪ 4: auto SH normal/DHW off



INFORMATION

The auto emergency setting can be set in the menu structure of the user interface only.



INFORMATION

If a heat pump failure occurs and **Emergency** is set to **Manual**, the room frost protection function, the underfloor heating screed dryout function, and the water pipe antifreeze function will remain active even if the user does NOT confirm emergency operation.

HP forced off

HP **forced off** mode can be activated to allow the backup heater to provide domestic hot water and space heating. When this mode is activated:

- Heat pump operation is NOT possible
- Cooling is NOT possible

#	Code	Description
[9.5.2]	[7-06]	Activation of the HP forced off mode: <ul style="list-style-type: none"> ▪ 0: disabled ▪ 1: enabled

Glycol filled system

Glycol Filled system

This setting gives the installer the possibility to indicate whether the system is filled with glycol or water. This is important in case glycol is used to protect the water circuit against freezing. If NOT set correctly, the liquid in the piping can freeze.

#	Code	Description
N/A	[E-0D]	Glycol Filled system: Is the system filled with glycol? <ul style="list-style-type: none"> ▪ 0: No ▪ 1: Yes

Balancing

Priorities

For systems with an integrated domestic hot water tank.

#	Code	Description
[9.6.1]	[5-02]	Space heating priority: Defines whether backup heater will assist the heat pump during domestic hot water operation. For optimal operation and lowest power consumption, it is strongly recommended to keep the default setting (0). If the backup heater operation is limited ([4-00]=0) and the outdoor temperature is lower than setting [5-03], the domestic hot water will not be heated with the backup heater.
[9.6.2]	[5-03]	Priority temperature: Used for calculation of anti-recycling timer. If [5-02]=1, it defines the outdoor temperature below which the backup heater will assist during domestic hot water heating. [5-01] Equilibrium temperature and [5-03] Space heating priority temperature are related to backup heater. So, you must set [5-03] equal or a few degrees higher than [5-01].

#	Code	Description
[9.6.3]	[5-04]	<p>Offset BSH setpoint: Setpoint correction for domestic hot water temperature: setpoint correction for the desired domestic hot water temperature, to be applied at low outdoor temperature when space heating priority is enabled. The corrected (higher) setpoint will make sure that the total heat capacity of the water in the tank remains approximately unchanged, by compensating for the colder bottom water layer of the tank (because the heat exchanger coil is not operational) with a warmer top layer.</p> <p>Range: 0°C~20°C</p>

Timers

For simultaneous space and domestic hot water operation request.

[8-02]: Anti-recycle timer

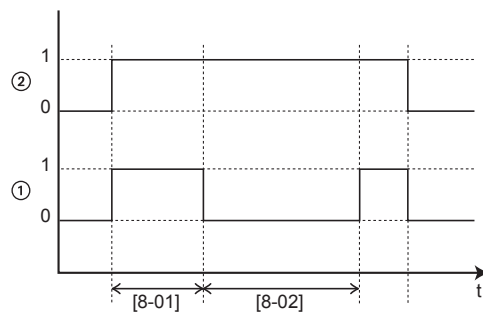

- 1 Heat pump domestic water heating mode (1=active, 0=not active)
- 2 Hot water request for heat pump (1=request, 0=no request)
- t Time

[8-04]: Additional timer at [4-02]/[F-01]

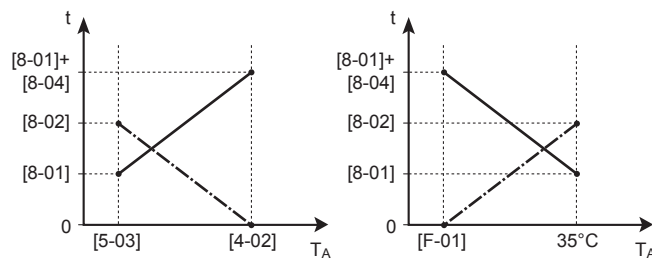

- T_A Ambient (outdoor) temperature
- t Time
- Anti-recycle timer
- Maximum running time domestic hot water

#	Code	Description
[9.6.4]	[8-02]	<p>Anti-recycle timer: Minimum time between two cycles for domestic hot water. The actual anti-recycling time also depends on setting [8-04].</p> <p>Range: 0~10 hours</p> <p>Remark: The minimum time is 0.5 hours even when the selected value is 0.</p>

#	Code	Description
[9.6.5]	[8-00]	Minimum running timer: Do NOT change.
[9.6.6]	[8-01]	Maximum running timer for domestic hot water operation. Domestic hot water heating stops even when the target domestic hot water temperature is NOT reached. The actual maximum running time also depends on setting [8-04]. <ul style="list-style-type: none"> When Control=Room thermostat: This preset value is only taken into account if there is a request for space heating or cooling. If there is NO request for space heating/cooling, the tank is heated until the setpoint has been reached. When Control≠Room thermostat: This preset value is always taken into account. Range: 5~95 minutes Remark: It is NOT allowed to set [8-01] to a value below 10 minutes.
[9.6.7]	[8-04]	Additional timer: Additional running time for the maximum running time depending on the outdoor temperature [4-02] or [F-01]. Range: 0~95 minutes

Water pipe freeze prevention

Only relevant for installations with water piping outdoors. This function tries to protect outdoor water piping from freezing.

#	Code	Description
[9.7]	[4-04]	Water pipe freeze prevention: <ul style="list-style-type: none"> 0: Intermittent (read only)



NOTICE

Water pipe freeze prevention. Even if you turn OFF space heating/cooling operation ([C.2]: Operation > Space heating/cooling), water pipe freeze prevention –if enabled– will remain active.

Preferential kWh rate power supply



INFORMATION

The preferential kWh rate power supply contact is connected to the same terminals (X5M/9+10) as the safety thermostat. Thus, the system can have EITHER preferential kWh rate power supply OR a safety thermostat.

#	Code	Description
[9.8.1]	[D-01]	<p>Connection to a Benefit kWh power supply or a Safety thermostat:</p> <ul style="list-style-type: none"> ▪ 0 No: The outdoor unit is connected to a normal power supply. ▪ 1 Open: The outdoor unit is connected to a preferential kWh rate power supply. When the preferential kWh rate signal is sent by the electricity company, the contact will open and the unit will go in forced off mode. When the signal is released again, the voltage-free contact will close and the unit will restart operation. Therefore, always enable the auto restart function. ▪ 2 Closed: The outdoor unit is connected to a preferential kWh rate power supply. When the preferential kWh rate signal is sent by the electricity company, the contact will close and the unit will go in forced off mode. When the signal is released again, the voltage-free contact will open and the unit will restart operation. Therefore, always enable the auto restart function. ▪ 3 Safety thermostat: A safety thermostat is connected to the system (normal closed contact)
[9.8.2]	[D-00]	<p>Allow heater: Which heaters are allowed to operate during preferential kWh rate power supply?</p> <ul style="list-style-type: none"> ▪ 0 No: None ▪ 1 Only BSH: Booster heater only ▪ 2 Only BUH: Backup heater only ▪ 3 All: All heaters <p>See table below.</p> <p>Setting 2 is only meaningful if the preferential kWh rate power supply is of type 1 or indoor unit is connected to a normal kWh rate power supply (via X2M/5-6) and the backup heater is NOT connected to the preferential kWh rate power supply.</p>
[9.8.3]	[D-05]	<p>Allow pump:</p> <ul style="list-style-type: none"> ▪ 0 No: Pump is forced off ▪ 1 Yes: No limitation

Allowed heaters during preferential kWh rate power supply

Do NOT use 1 or 3. Setting [D-00] to 1 or 3 when [D-01] is set to 1 or 2 will reset [D-00] back to 0, as the system does not have a booster heater. Only set [D-00] to the values in the table below:

[D-00]	Backup heater	Compressor
0	Forced OFF	Forced OFF
2	Allowed	

Power consumption control

Power consumption control

See "5 Application guidelines" [▶ 26] for detailed information about this functionality.

#	Code	Description
[9.9.1]	[4-08]	Power consumption control: <ul style="list-style-type: none"> ▪ 0 No: Disabled. ▪ 1 Continuous: Enabled: You can set one power limitation value (in A or kW) to which the system power consumption will be limited for all the time. ▪ 2 Inputs: Enabled: You can set up to four different power limitation values (in A or kW) to which the system power consumption will be limited when the corresponding digital input asks.
[9.9.2]	[4-09]	Type: <ul style="list-style-type: none"> ▪ 0 Amp: The limitation values are set in A. ▪ 1 kW: The limitation values are set in kW.

Limit when [9.9.1]=**Continuous** and [9.9.2]=**Amp**:

#	Code	Description
[9.9.3]	[5-05]	Limit: Only applicable in case of full time current limitation mode. 0 A~50 A

Limits when [9.9.1]=**Inputs** and [9.9.2]=**Amp**:

#	Code	Description
[9.9.4]	[5-05]	Limit 1: 0 A~50 A
[9.9.5]	[5-06]	Limit 2: 0 A~50 A
[9.9.6]	[5-07]	Limit 3: 0 A~50 A
[9.9.7]	[5-08]	Limit 4: 0 A~50 A

Limit when [9.9.1]=**Continuous** and [9.9.2]=**kW**:

#	Code	Description
[9.9.8]	[5-09]	Limit: Only applicable in case of full time power limitation mode. 0 kW~20 kW

Limits when [9.9.1]=**Inputs** and [9.9.2]=**kW**:

#	Code	Description
[9.9.9]	[5-09]	Limit 1: 0 kW~20 kW

#	Code	Description
[9.9.A]	[5-0A]	Limit 2: 0 kW~20 kW
[9.9.B]	[5-0B]	Limit 3: 0 kW~20 kW
[9.9.C]	[5-0C]	Limit 4: 0 kW~20 kW

Priority heater

#	Code	Description
[9.9.D]	[4-01]	<p>Power consumption control DISABLED [4-08]=0</p> <ul style="list-style-type: none"> 0 None : Backup heater and booster heater can operate simultaneously. 1 Booster heater: The booster heater is prioritised. 2 Backup heater: The backup heater is prioritised. <p>Power consumption control ENABLED [4-08]=1/2</p> <ul style="list-style-type: none"> 0 None : Depending on the power limitation level, the booster heater will be limited first, before the backup heater is limited. 1 Booster heater: Depending on the power limitation level, the backup heater will be limited first, before the booster heater is limited. 2 Backup heater: Depending on the power limitation level, the booster heater will be limited first, before the backup heater is limited.

Note: In case power consumption control is DISABLED (for all models) the setting [4-01] defines whether backup heater and booster heater can operate simultaneously, or if the booster heater/backup heater has priority over the backup heater/booster heater.

In case power consumption control is ENABLED, the setting [4-01] defines the priority of the electrical heaters depending on applicable limitation.

BBR16

See "[BBR16 power limitation](#)" [▶ 52] for detailed information about this functionality.



INFORMATION

Restriction: BBR16 settings are only visible when the language of the user interface is set to Swedish.



NOTICE

2 weeks to change. After you activated BBR16, you only have 2 weeks to change its settings (BBR16 activation and BBR16 power limit). After 2 weeks, the unit freezes these settings.

Note: This is different from the permanent power limitation, which is always changeable.

BBR16 activation

#	Code	Description
[9.9.F]	[7-07]	BBR16 activation: <ul style="list-style-type: none"> ▪ 0: disabled ▪ 1: enabled

BBR16 power limit

#	Code	Description
[9.9.G]	[N/A]	BBR16 power limit: This setting can only be modified via the menu structure. <ul style="list-style-type: none"> ▪ 0 kW~25 kW, step 0.1 kW

Energy metering**Energy metering**

If energy metering is performed by the use of external power meters, configure the settings as described below. Select the pulse frequency output of each power meter in accordance with the power meter specifications. It is possible to connect up to 2 power meters with different pulse frequencies. If only 1 or no power meter is used, select 'None' to indicate the corresponding pulse input is NOT used.

#	Code	Description
[9.A.1]	[D-08]	Electricity meter 1: <ul style="list-style-type: none"> ▪ 0 None: NOT installed ▪ 1 1/10kWh: Installed ▪ 2 1/kWh: Installed ▪ 3 10/kWh: Installed ▪ 4 100/kWh: Installed ▪ 5 1000/kWh: Installed
[9.A.2]	[D-09]	Electricity meter 2: <ul style="list-style-type: none"> ▪ 0 None: NOT installed ▪ 1 1/10kWh: Installed ▪ 2 1/kWh: Installed ▪ 3 10/kWh: Installed ▪ 4 100/kWh: Installed ▪ 5 1000/kWh: Installed

Sensors

External sensor

#	Code	Description
[9.B.1]	[C-08]	<p>External sensor: When an optional external ambient sensor is connected, the type of the sensor must be set.</p> <ul style="list-style-type: none"> 0 None : NOT installed. The thermistor in the dedicated Human Comfort Interface and in the outdoor unit are used for measurement. 1 Outdoor: Connected to PCB of the indoor unit measuring the outdoor temperature. Remark: For some functionality, the temperature sensor in the outdoor unit is still used. 2 Room: Connected to PCB of the indoor unit measuring the indoor temperature. The temperature sensor in the dedicated Human Comfort Interface is NOT used anymore. Remark: This value has only meaning in room thermostat control.

Ext. amb. sensor offset

ONLY applicable in case an external outdoor ambient sensor is connected and configured.

You can calibrate the external outdoor ambient temperature sensor. It is possible to give an offset to the thermistor value. This setting can be used to compensate for situations where the external outdoor ambient sensor cannot be installed on the ideal installation location.

#	Code	Description
[9.B.2]	[2-0B]	<p>Ext. amb. sensor offset: Offset on the ambient temperature measured on the external outdoor temperature sensor.</p> <ul style="list-style-type: none"> -5°C~5°C, step 0.5°C

Averaging time

The average timer corrects the influence of ambient temperature variations. The weather-dependent setpoint calculation is done on the average outdoor temperature.

The outdoor temperature is averaged over the selected time period.

#	Code	Description
[9.B.3]	[1-0A]	<p>Averaging time:</p> <ul style="list-style-type: none"> 0: No averaging 1: 12 hours 2: 24 hours 3: 48 hours 4: 72 hours

Bivalent

Bivalent

Only applicable in case of auxiliary boiler.



NOTICE

Bivalent operation is only possible if:

- Space heating is turned ON, and
- DHW tank operation is turned OFF.

About bivalent

The purpose of this function is to determine which heating source can/will provide the space heating, either the heat pump system or the auxiliary boiler.

#	Code	Description
[9.C.1]	[C-02]	<p>Bivalent: Indicates if the space heating is also performed by means of another heat source than the system.</p> <ul style="list-style-type: none"> ▪ 0 No: Not installed ▪ 1 Yes: Installed. The auxiliary boiler (gas boiler, oil burner) will operate when the outdoor ambient temperature is low. During bivalent operation, the heat pump is turned off. Set this value in case an auxiliary boiler is used.

- If **Bivalent** is enabled: When the outdoor temperature drops below the bivalent ON temperature (fixed or variable based on energy prices), the space heating by the heat pump stops automatically and the permission signal for the auxiliary boiler is active.
- If **Bivalent** is disabled: Space heating is only done by the heat pump within the operation range. The permission signal for the auxiliary boiler is always inactive.

The switch-over between the heat pump system and the auxiliary boiler is based on the following settings:

- [C-03] and [C-04]
- Electricity and gas prices ([7.5.1], [7.5.2], [7.5.3], and [7.6])

[C-03], [C-04], and T_{calc}

Based on the settings above, the heat pump system calculates a value T_{calc} , which is variable between [C-03] and [C-03]+[C-04].

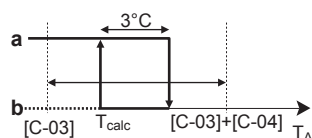

- T_A Outdoor temperature
- T_{calc} Bivalent ON temperature (variable). Below this temperature, the auxiliary boiler will always be ON. T_{calc} can never go below [C-03] or above [C-03]+[C-04].
- 3°C** Fixed hysteresis to prevent too much switching between heat pump system and auxiliary boiler
- a** Auxiliary boiler active
- b** Auxiliary boiler inactive

If the outdoor temperature...	Then...	
	Space heating by the heat pump system...	Bivalent signal for the auxiliary boiler is...
Drops below T_{calc}	Stops	Active
Rises above $T_{calc}+3^{\circ}\text{C}$	Starts	Inactive



INFORMATION

The permission signal for the auxiliary boiler is located on the EGRP1HBAA (digital I/O PCB). When it is activated, the contact X1, X2 is closed and open when it is deactivated. See illustration below for the schematic location of this contact.

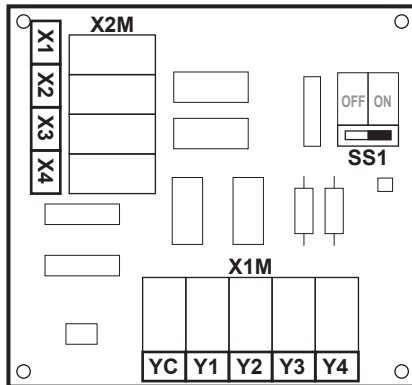

#	Code	Description
9.C.3	[C-03]	Range: $-25^{\circ}\text{C}\sim 25^{\circ}\text{C}$ (step: 1°C)
9.C.4	[C-04]	Range: $2^{\circ}\text{C}\sim 10^{\circ}\text{C}$ (step: 1°C) The higher the value of [C-04], the higher the accuracy of the switch-over between the heat pump system and the auxiliary boiler.

To determine the value of [C-03], proceed as follows:

- 1 Determine the COP (= coefficient of performance) using the formula:

Formula	Example
$\text{COP} = (\text{Electricity price} / \text{gas price})^{(a)} \times \text{boiler efficiency}$	If: <ul style="list-style-type: none"> ▪ Electricity price: 20 c€/kWh ▪ Gas price: 6 c€/kWh ▪ Boiler efficiency: 0.9 Then: $\text{COP} = (20/6) \times 0.9 = 3$

^(a) Make sure to use the same units of measurement for the electricity price and gas price (example: both c€/kWh).

- 2 Determine the value of [C-03] using the graph. For an example, see the table legend.

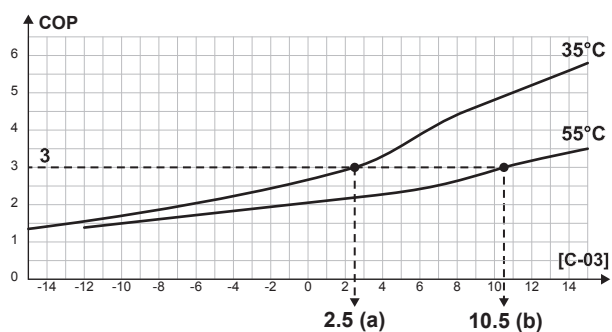

- a [C-03]=2.5 in case of COP=3 and LWT=35°C
 b [C-03]=10.5 in case of COP=3 and LWT=55°C



NOTICE

Make sure to set the value of [5-01] at least 1°C higher than the value of [C-03].

Electricity and gas prices



INFORMATION

To set electricity and gas price values, do NOT use overview settings. Set them in the menu structure instead ([7.5.1], [7.5.2], [7.5.3], and [7.6]). For more information on how to set the energy prices, see the operation manual and the user reference guide.



INFORMATION

Solar panels. If solar panels are used, set the electricity price value very low to promote the use of the heat pump.

#	Code	Description
[7.5.1]	N/A	User settings > Electricity price > High
[7.5.2]	N/A	User settings > Electricity price > Medium
[7.5.3]	N/A	User settings > Electricity price > Low
[7.6]	N/A	User settings > Gas price

Alarm output

Alarm output

#	Code	Description
[9.D]	[C-09]	<p>Alarm output: Indicates the logic of the alarm output on the digital I/O PCB during malfunctioning.</p> <ul style="list-style-type: none"> ▪ 0 Abnormal: The alarm output will be powered when an alarm occurs. By setting this value, a distinction is made between the detection of an alarm, and the detection of a power failure. ▪ 1 Normal: The alarm output will NOT be powered when an alarm occurs. <p>See also table below (Alarm output logic).</p>

Alarm output logic

[C-09]	Alarm	No alarm	No power supply to unit
0	Closed output	Open output	Open output
1	Open output	Closed output	

Auto restart

Auto restart

When power returns after a power supply failure, the auto restart function reapplies the user interface settings at the time of the power failure. Therefore, it is recommended to always enable the function.

If the preferential kWh rate power supply is of the type that power supply is interrupted, always enable the auto restart function. Continuous indoor unit control can be guaranteed independent of the preferential kWh rate power supply status, by connecting the indoor unit to a separate normal kWh rate power supply.

#	Code	Description
[9.E]	[3-00]	<p>Auto restart:</p> <ul style="list-style-type: none"> ▪ 0: Manual ▪ 1: Automatic

Power saving function

Power saving function



NOTICE

Power saving function. The power saving function is only applicable for V3 models. If you want to use the power saving function, on the outdoor unit PCB make sure to connect X804A to X806A. For more information, see "[In case of V3 models](#)" [▶ 92].

Defines whether the outdoor unit power supply can be interrupted (internally by indoor unit control) during stand-still conditions (no space heating/cooling nor domestic hot water demand). The final decision to allow power interruption of the outdoor unit during standstill depends on the ambient temperature, compressor conditions and minimum internal timers.

To enable the power saving function setting, [E-08] needs to be enabled on the user interface.

#	Code	Description
[9.F]	[E-08]	Power saving function for outdoor unit: <ul style="list-style-type: none"> ▪ 0: No ▪ 1: Yes

Disable protections



INFORMATION

Protective functions – "Installer-on-site mode". The software is equipped with protective functions, such as room antifrost. The unit automatically runs these functions when necessary.

During installation or service this behaviour is undesired. Therefore, the protective functions can be disabled:

- **At first power-on:** The protective functions are disabled by default. After 36 h they will be automatically enabled.
- **Afterwards:** An installer can manually disable the protective functions by setting [9.G]: **Disable protections=Yes**. After his work is done, he can enable the protective functions by setting [9.G]: **Disable protections=No**.

#	Code	Description
[9.G]	N/A	Disable protections: <ul style="list-style-type: none"> ▪ 0: No ▪ 1: Yes

Forced defrost

Forced defrost

Manually start a defrost operation.

#	Code	Description
[9.H]	N/A	Do you want to start a defrost operation? <ul style="list-style-type: none"> ▪ Back ▪ OK



NOTICE

Forced defrost start-up. You can only start forced defrost when the heating operation has been running for a while.

Overview field settings

All settings can be done using the menu structure. If for any reason it is required to change a setting using the overview settings, then the overview settings can be accessed in the field settings overview [9.I]. See ["To modify an overview setting"](#) [▶ 117].

Export MMI settings

About exporting the configuration settings

Export the configuration settings of the unit to a USB memory stick, via the MMI (the user interface of the indoor unit). When troubleshooting, these settings can be provided to our Service department.

#	Code	Description
[9.N]	N/A	Your MMI settings will be exported to the connected storage device: <ul style="list-style-type: none"> ▪ Back ▪ OK

To export MMI settings

1	Open the user interface panel and insert a USB memory stick.	—
2	On the user interface, go to [9.N] Export MMI settings.	⏪...○
3	Select OK.	⏪...○
4	Remove the USB memory stick and close the user interface panel.	—

9.5.10 Commissioning

Overview

The following items are listed in the submenu:

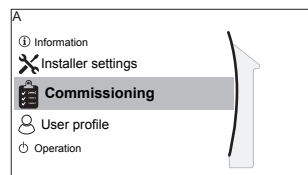

[A] Commissioning

[A.1] Operation test run

[A.2] Actuator test run

[A.3] Air purge

[A.4] UFH screed dryout

About commissioning

See: "10 Commissioning" [▶ 199]

9.5.11 Operation

Overview

The following items are listed in the submenu:

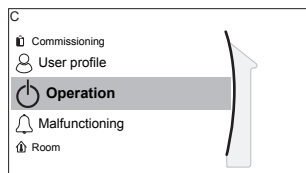

[C] Operation

[C.1] Room

[C.2] Space heating/cooling

[C.3] Tank

To enable or disable functionalities

In the operation menu, you can separately enable or disable functionalities of the unit.

#	Code	Description
[C.1]	N/A	Room: <ul style="list-style-type: none"> ▪ 0: Off ▪ 1: On
[C.2]	N/A	Space heating/cooling: <ul style="list-style-type: none"> ▪ 0: Off ▪ 1: On
[C.3]	N/A	Tank: <ul style="list-style-type: none"> ▪ 0: Off ▪ 1: On

9.5.12 WLAN



INFORMATION

Restriction: WLAN settings are only visible when a WLAN adapter is installed.

Overview

The following items are listed in the submenu:

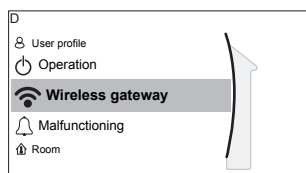

[D] Wireless gateway

[D.1] Mode

[D.2] WPS

[D.3] Reboot



[D.4] Device info

About the WLAN adapter

The wireless LAN adapter connects the heat pump system to the internet. The user can then control the heat pump system via the Daikin Residential Controller app.

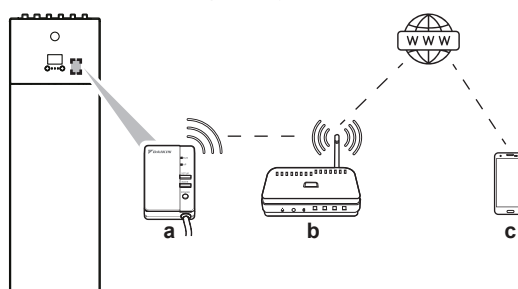
This needs the following components:



a	WLAN adapter	<p>The WLAN adapter needs to be installed by the installer on the indoor unit (on the inside of the front panel). See:</p> <ul style="list-style-type: none"> ▪ Installation manual of the WLAN adapter ▪ Addendum book for optional equipment
b	Router	Field supply.
c	<p>Smartphone + app</p> 	<p>The Daikin Residential Controller app needs to be installed on the user's smartphone. See:</p> <p>http://www.onlinecontroller.daikineurope.com/</p> 

Configuration

To configure the Daikin Residential Controller app, follow the in-app instructions. While doing this, the following actions and information are needed on the user interface of the indoor unit:

Mode: Turn AP mode ON (= WLAN adapter active as access point) or OFF.

#	Code	Description
[D.1]	N/A	<p>Enable AP mode:</p> <ul style="list-style-type: none"> ▪ No ▪ Yes

WPS: Connect the WLAN adapter to the router.

#	Code	Description
[D.2]	N/A	<p>Connect to home network:</p> <ul style="list-style-type: none"> ▪ Back ▪ OK

Reboot: Reset the WLAN adapter.

#	Code	Description
[D.3]	N/A	<p>Reboot the gateway:</p> <ul style="list-style-type: none"> ▪ Back ▪ OK

Device info: Consult information about the WLAN adapter.

#	Code	Description
[D.4]	N/A	<p>Device info:</p> <ul style="list-style-type: none"> ▪ SSID ▪ MAC address ▪ Serial number

9.6 Menu structure: Overview user settings

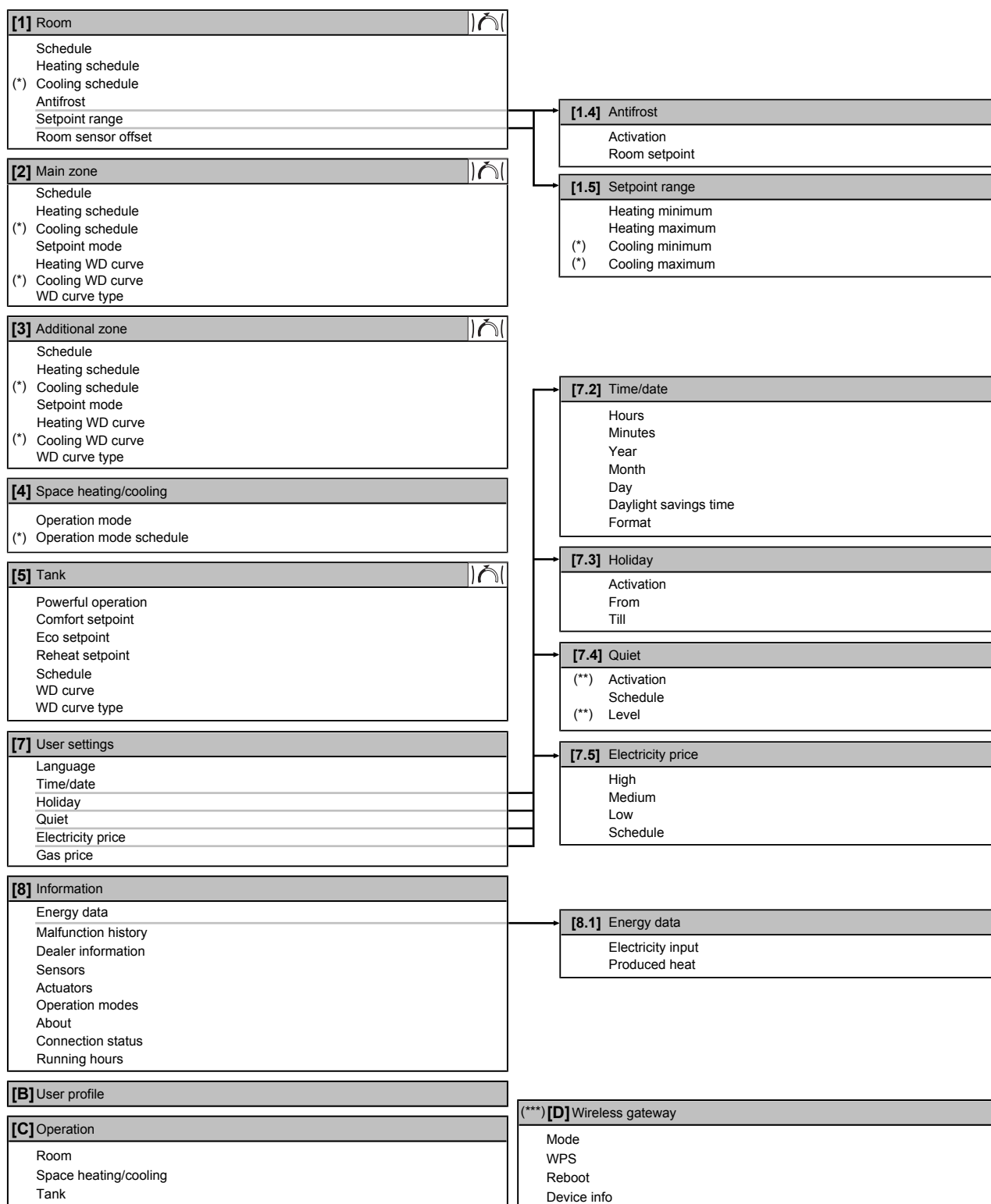

Setpoint screen

(*)

Only applicable for reversible models, or heating only models + conversion kit

(**)

Only accessible by installer

(***)

Only applicable when WLAN adapter is installed

**INFORMATION**

Depending on the selected installer settings and unit type, settings will be visible/invisible.

9.7 Menu structure: Overview installer settings

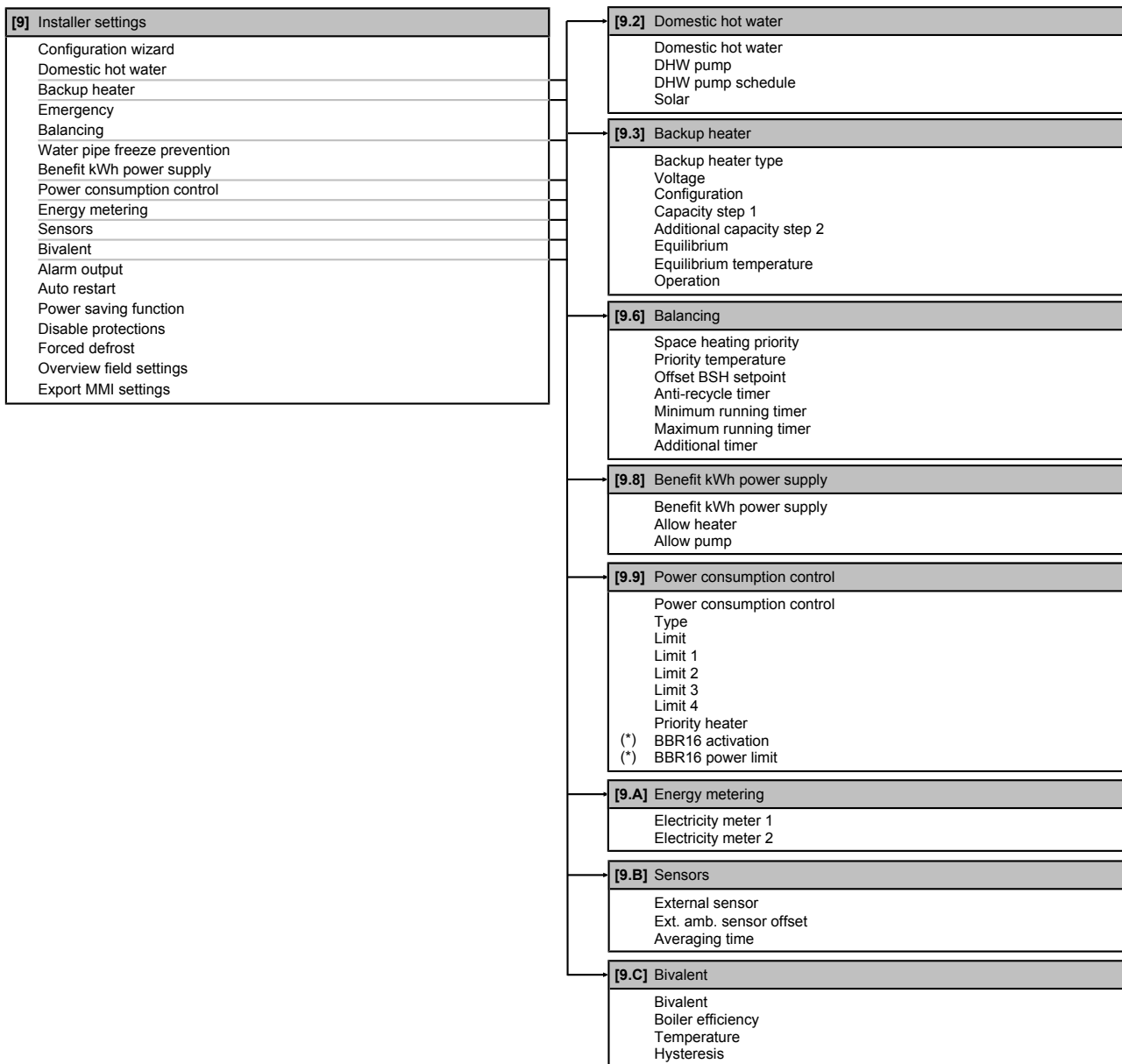

(*) Only applicable in Swedish language.



INFORMATION

Solar kit settings are shown but are NOT applicable for this unit. Settings shall NOT be used or changed.



INFORMATION

Depending on the selected installer settings and unit type, settings will be visible/invisible.

10 Commissioning



NOTICE

General commissioning checklist. Next to the commissioning instructions in this chapter, a general commissioning checklist is also available on the Daikin Business Portal (authentication required).

The general commissioning checklist is complementary to the instructions in this chapter and can be used as a guideline and reporting template during the commissioning and hand-over to the user.



NOTICE

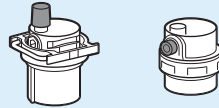

Make sure both air purge valves (one on the magnetic filter and one on the backup heater) are open.

All automatic air purge valves must remain open after commissioning.



INFORMATION

Protective functions – "Installer-on-site mode". The software is equipped with protective functions, such as room antifrost. The unit automatically runs these functions when necessary.

During installation or service this behaviour is undesired. Therefore, the protective functions can be disabled:

- **At first power-on:** The protective functions are disabled by default. After 12 h they will be automatically enabled.
- **Afterwards:** An installer can manually disable the protective functions by setting [9.G]: **Disable protections=Yes**. After his work is done, he can enable the protective functions by setting [9.G]: **Disable protections=No**.

In this chapter

10.1	Overview: Commissioning	199
10.2	Precautions when commissioning	200
10.3	Checklist before commissioning	200
10.4	Checklist during commissioning	201
10.4.1	Minimum flow rate	201
10.4.2	Air purge function	202
10.4.3	Operation test run	203
10.4.4	Actuator test run	204
10.4.5	Underfloor heating screed dryout	205

10.1 Overview: Commissioning

This chapter describes what you have to do and know to commission the system after it is installed and configured.

Typical workflow

Commissioning typically consists of the following stages:

- 1 Checking the "Checklist before commissioning".
- 2 Performing an air purge.
- 3 Performing a test run for the system.
- 4 If necessary, performing a test run for one or more actuators.
- 5 If necessary, performing an underfloor heating screed dryout.

10.2 Precautions when commissioning



INFORMATION

During the first running period of the unit, the required power may be higher than stated on the nameplate of the unit. This phenomenon is caused by the compressor, that needs a continuous run time of 50 hours before reaching smooth operation and stable power consumption.



NOTICE

ALWAYS operate the unit with thermistors and/or pressure sensors/switches. If NOT, burning of the compressor might be the result.

10.3 Checklist before commissioning

After the installation of the unit, first check the items listed below. Once all checks are fulfilled, the unit must be closed. Power-up the unit after it is closed.

<input type="checkbox"/>	You read the complete installation instructions, as described in the installer reference guide .
<input type="checkbox"/>	The indoor unit is properly mounted.
<input type="checkbox"/>	The outdoor unit is properly mounted.
<input type="checkbox"/>	The following field wiring has been carried out according to this document and the applicable legislation: <ul style="list-style-type: none"> ▪ Between the local supply panel and the outdoor unit ▪ Between indoor unit and outdoor unit ▪ Between the local supply panel and the indoor unit ▪ Between the indoor unit and the valves (if applicable) ▪ Between the indoor unit and the room thermostat (if applicable)
<input type="checkbox"/>	The system is properly earthed and the earth terminals are tightened.
<input type="checkbox"/>	The fuses or locally installed protection devices are installed according to this document, and have NOT been bypassed.
<input type="checkbox"/>	The power supply voltage matches the voltage on the identification label of the unit.
<input type="checkbox"/>	There are NO loose connections or damaged electrical components in the switch box.
<input type="checkbox"/>	There are NO damaged components or squeezed pipes on the inside of the indoor and outdoor units.
<input type="checkbox"/>	Backup heater circuit breaker F1B (field supply) is turned ON.
<input type="checkbox"/>	The correct pipe size is installed and the pipes are properly insulated.

<input type="checkbox"/>	There is NO water leak inside the indoor unit.
<input type="checkbox"/>	The shut-off valves are properly installed and fully open.
<input type="checkbox"/>	The automatic air purge valves are open.
<input type="checkbox"/>	The pressure relief valve purges water when opened. Clean water must come out.
<input type="checkbox"/>	The minimum water volume is guaranteed in all conditions. See "To check the water volume and flow rate" in " 7.1 Preparing water piping " [▶ 73].
<input type="checkbox"/>	The domestic hot water tank is filled completely.

10.4 Checklist during commissioning

<input type="checkbox"/>	The minimum flow rate during backup heater/defrost operation is guaranteed in all conditions. See "To check the water volume and flow rate" in " 7.1 Preparing water piping " [▶ 73].
<input type="checkbox"/>	To perform an air purge .
<input type="checkbox"/>	To perform a test run .
<input type="checkbox"/>	To perform an actuator test run .
<input type="checkbox"/>	Underfloor screed dryout function The underfloor screed dryout function is started (if necessary).

10.4.1 Minimum flow rate

Purpose

For a correct operating unit, it is important to check if the minimum flow rate is reached. If needed, modify the bypass valve setting.

Minimum required flow rate
25 l/min

To check the minimum flow rate

1	Check the hydraulic configuration to find out which space heating loops can be closed by mechanical, electronic, or other valves.	—
2	Close all space heating loops that can be closed.	—
3	Start the pump test run (see " Actuator test run " [▶ 204]).	—
4	Read out the flow rate ^(a) and modify the bypass valve setting to reach the minimum required flow rate + 2 l/min.	—

^(a) During pump test run, the unit can operate below the minimum required flow rate.

10.4.2 Air purge function

Purpose

When commissioning and installing the unit, it is very important to remove all air in the water circuit. When the air purge function is running, the pump operates without actual operation of the unit and the removal of air in the water circuit will start.

**NOTICE**

Before starting the air purge, open the safety valve and check if the circuit is sufficiently filled with water. Only if water escapes the valve after opening it, you can start the air purge procedure.

Manual or automatic

There are 2 modes for purging air:

- **Manual:** You can set the pump speed to low or high. You can set the circuit (the position of the 3-way valve) to Space or Tank. Air purge must be performed for both space heating and tank (domestic hot water) circuits.
- **Automatic:** The unit automatically changes the pump speed and switches the position of the 3-way valve between the space heating and the domestic hot water circuit.

Typical workflow

Purging the air from the system should consist of:

- 1 Performing a manual air purge
- 2 Performing an automatic air purge

**INFORMATION**

Start by performing a manual air purge. When almost all the air is removed, perform an automatic air purge. If necessary, repeat performing the automatic air purge until you are sure that all air is removed from the system. During air purge function, pump speed limitation [9-0D] is NOT applicable.

The air purge function automatically stops after 30 minutes.







**INFORMATION**

For best results, air purge each loop separately.

To perform a manual air purge







Conditions: Make sure all operation is disabled. Go to [C]: **Operation** and turn off **Room, Space heating/cooling** and **Tank** operation.

1	Set the user permission level to Installer . See " To change the user permission level " [▶ 116].	—
2	Go to [A.3]: Commissioning > Air purge .	
3	In the menu, set Type = Manual .	
4	Select Start air purge .	
5	Select OK to confirm.	
Result: The air purge starts. It stops automatically when ready.		

6	During manual operation:	
	<ul style="list-style-type: none"> You can change the pump speed. You must change the circuit. <p>To change these settings during the air purge, open the menu and go to [A.3.1.5]: Settings.</p>	
	<ul style="list-style-type: none"> Scroll to Circuit and set it to Space/Tank. 	 
	<ul style="list-style-type: none"> Scroll to Pump speed and set it to Low/High. 	 
7	To stop the air purge manually:	—
	1 Open the menu and go to Stop air purge .	
	2 Select OK to confirm.	

To perform an automatic air purge

Conditions: Make sure all operation is disabled. Go to [C]: **Operation** and turn off **Room, Space heating/cooling** and **Tank** operation.

1	Set the user permission level to Installer . See " To change the user permission level " [▶ 116].	—
2	Go to [A.3]: Commissioning > Air purge .	
3	In the menu, set Type = Automatic .	
4	Select Start air purge .	
5	Select OK to confirm. Result: The air purge starts. It stops automatically when done.	
6	To stop the air purge manually:	—
	1 In the menu, go to Stop air purge .	
	2 Select OK to confirm.	

10.4.3 Operation test run



Purpose



Perform test runs on the unit and monitor the leaving water and tank temperatures to check if the unit is working correctly. The following test runs should be made:

- Heating
- Cooling (if applicable)
- Tank

To perform an operation test run

Conditions: Make sure all operation is disabled. Go to [C]: **Operation** and turn off **Room, Space heating/cooling** and **Tank** operation.

1	Set the user permission level to Installer . See " To change the user permission level " [▶ 116].	—
2	Go to [A.1]: Commissioning > Operation test run .	
3	Select a test from the list. Example: Heating.	

4	Select OK to confirm.	
	Result: The test run starts. It stops automatically when ready (± 30 min).	
	To stop the test run manually:	—
1	In the menu, go to Stop test run .	
2	Select OK to confirm.	



**INFORMATION**

If the outdoor temperature is outside the range of operation, the unit may NOT operate or may NOT deliver the required capacity.

To monitor leaving water and tank temperatures

During test run, the correct operation of the unit can be checked by monitoring its leaving water temperature (heating/cooling mode) and tank temperature (domestic hot water mode).

To monitor the temperatures:

1	In the menu, go to Sensors .	
2	Select the temperature information.	





10.4.4 Actuator test run

Purpose

Perform an actuator test run to confirm the operation of the different actuators. For example, when you select **Pump**, a test run of the pump will start.

To perform an actuator test run

Conditions: Make sure all operation is disabled. Go to [C]: **Operation** and turn off **Room, Space heating/cooling** and **Tank** operation.

1	Set the user permission level to Installer. See " To change the user permission level " [▶ 116].	—
2	Go to [A.2]: Commissioning > Actuator test run .	
3	Select a test from the list. Example: Pump .	
4	Select OK to confirm.	
	Result: The actuator test run starts. It stops automatically when ready (± 30 min).	
	To stop the test run manually:	—
1	In the menu, go to Stop test run .	
2	Select OK to confirm.	

Possible actuator test runs

- Backup heater 1 test
- Backup heater 2 test
- Pump test

**INFORMATION**

Make sure that all air is purged before executing the test run. Also avoid disturbances in the water circuit during the test run.

- Shut off valve test
- Diverter valve test (3-way valve for switching between space heating and tank heating)
- Bivalent signal test
- Alarm output test
- C/H signal test
- DHW pump test

10.4.5 Underfloor heating screed dryout

About underfloor heating screed dryout**Purpose**

The underfloor heating (UFH) screed dryout function is used for drying out the screed of an underfloor heating system during the construction of the building.

**NOTICE**

The installer is responsible for:

- contacting the screed manufacturer for the maximum allowed water temperature, to avoid cracking the screed,
- programming the underfloor heating screed dryout schedule according to the initial heating instructions of the screed manufacturer,
- checking the proper functioning of the setup on a regular basis,
- performing the correct program complying with the type of the used screed.

UFH screed dryout before or during installation of outdoor unit

The UFH screed dryout function can be executed without finishing the outdoor installation. In this case, the backup heater will perform the screed dryout and supply the leaving water without heat pump operation.

To program an underfloor heating screed dryout schedule**Duration and temperature**

The installer can program up to 20 steps. For each step he needs to enter:

- 1 the duration in hours, up to 72 hours,
- 2 the desired leaving water temperature, up to 55°C.

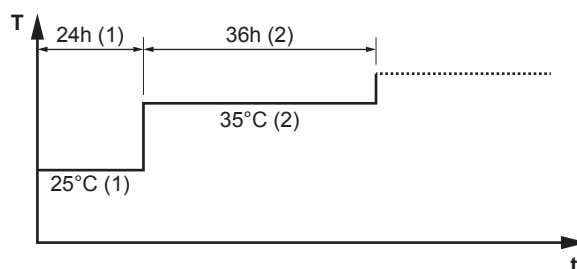
Example:

T Desired leaving water temperature (15~55°C)

- t Duration (1~72 h)
(1) Action step 1
(2) Action step 2

Steps

1	Set the user permission level to Installer . See "To change the user permission level" [▶ 116].	—
2	Go to [A.4.2]: Commissioning > UFH screed dryout > Program .	
3	Program the schedule: To add a new step, select the next empty line and change its value. To delete a step and all steps below it, decrease the duration to "—".	—
	<ul style="list-style-type: none"> ▪ Scroll through the schedule. 	
	<ul style="list-style-type: none"> ▪ Adjust the duration (between 1 and 72 hours) and temperatures (between 15°C and 55°C). 	
4	Press the left dial to save the schedule.	

To perform an underfloor heating screed dryout



INFORMATION

- If **Emergency** is set to **Manual** ([9.5]=0), and the unit is triggered to start emergency operation, the user interface will ask confirmation before starting. The underfloor heating screed dryout function is active even if the user does NOT confirm emergency operation.
- During underfloor heating screed dryout, pump speed limitation [9-0D] is NOT applicable.



NOTICE

To perform an underfloor heating screed dryout, room frost protection needs to be disabled ([2-06]=0). By default, it is enabled ([2-06]=1). However, due to the "installer-on-site" mode (see "Commissioning"), room frost protection will be automatically disabled for 12 hours after the first power-on.

If the screed dryout still needs to be performed after the first 12 hours of power-on, manually disable room frost protection by setting [2-06] to "0", and KEEP it disabled until the screed dryout has finished. Ignoring this notice will result in cracking of the screed.



NOTICE





For the underfloor heating screed dryout to be able to start, make sure the following settings are met:

- [4-00]=1
- [C-02]=0
- [D-01]=0
- [4-08]=0
- [4-01]≠1

Steps



Conditions: An underfloor heating screed dryout schedule has been programmed. See ["To program an underfloor heating screed dryout schedule"](#) [▶ 205].

Conditions: Make sure all operation is disabled. Go to [C]: **Operation** and turn off **Room, Space heating/cooling** and **Tank operation**.

1	Set the user permission level to Installer . See " To change the user permission level " [▶ 116].	—
2	Go to [A.4]: Commissioning > UFH screed dryout .	
3	Select Start UFH screed dryout .	
4	Select OK to confirm. Result: The underfloor heating screed dryout starts. It stops automatically when done.	
5	To stop the underfloor heating screed dryout manually:	—
1	Open the menu and go to Stop UFH screed dryout .	
2	Select OK to confirm.	

To read out the status of an underfloor heating screed dryout

Conditions: You are performing an underfloor heating screed dryout.

1	Press the back button. Result: A graph is displayed, highlighting the current step of the screed dryout schedule, the total remaining time, and the current desired leaving water temperature.	
2	Press the left dial to open the menu structure and to:	
1	View the status of sensors and actuators.	—
2	Adjust the current program	—

To stop an underfloor heating (UFH) screed dryout



U3-error

When the program is stopped by an error or an operation switch off, the U3 error will be displayed on the user interface. To resolve the error codes, see "[13.4 Solving problems based on error codes](#)" [▶ 224].

In case of a power failure, the U3 error is not generated. When power is restored, the unit automatically restarts the latest step and continues the program.

Stop UFH screed dryout

To manually stop underfloor heating screed dryout:

1	Go to [A.4.3]: Commissioning > UFH screed dryout	—
2	Select Stop UFH screed dryout .	
3	Select OK to confirm. Result: The underfloor heating screed dryout is stopped.	

Read out UFH screed dryout status

When the program is stopped due to an error, an operation switch-off, or a power failure, you can read out the underfloor heating screed dryout status:

1	Go to [A.4.3]: Commissioning > UFH screed dryout > Status	
----------	--	---

2	You can read out the value here: Stopped at + the step where the underfloor screed dryout was stopped.	—
3	Modify and restart the execution of the program ^(a) .	—

^(a) If the UFH screed dryout program was stopped due to a power failure and the power resumes, the program will automatically restart the last implemented step.

11 Hand-over to the user

Once the test run is finished and the unit operates properly, please make sure the following is clear for the user:

- Fill in the installer setting table (in the operation manual) with the actual settings.
- Make sure that the user has the printed documentation and ask him/her to keep it for future reference. Inform the user that he can find the complete documentation at the URL mentioned earlier in this manual.
- Explain the user how to properly operate the system and what to do in case of problems.
- Show the user what to do for the maintenance of the unit.
- Explain the user about energy saving tips as described in the operation manual.

12 Maintenance and service



NOTICE

General maintenance/inspection checklist. Next to the maintenance instructions in this chapter, a general maintenance/inspection checklist is also available on the Daikin Business Portal (authentication required).

The general maintenance/inspection checklist is complementary to the instructions in this chapter and can be used as a guideline and reporting template during maintenance.



NOTICE

Maintenance **MUST** be done by an authorized installer or service agent.

We recommend performing maintenance at least once a year. However, applicable legislation might require shorter maintenance intervals.

In this chapter

12.1	Overview: Maintenance and service.....	210
12.2	Maintenance safety precautions.....	210
12.3	Yearly maintenance	211
12.3.1	Yearly maintenance outdoor unit: overview.....	211
12.3.2	Yearly maintenance outdoor unit: instructions.....	211
12.3.3	Yearly maintenance indoor unit: overview.....	211
12.3.4	Yearly maintenance indoor unit: instructions	211
12.4	To drain the domestic hot water tank	214
12.5	About cleaning the water filter in case of trouble.....	214
12.5.1	To remove the water filter.....	215
12.5.2	To clean the water filter in case of trouble	215
12.5.3	To install the water filter.....	216

12.1 Overview: Maintenance and service

This chapter contains information about:

- The yearly maintenance of the outdoor unit
- The yearly maintenance of the indoor unit

12.2 Maintenance safety precautions



DANGER: RISK OF ELECTROCUTION



DANGER: RISK OF BURNING/SCALDING



NOTICE: Risk of electrostatic discharge

Before performing any maintenance or service work, touch a metal part of the unit in order to eliminate static electricity and to protect the PCB.

12.3 Yearly maintenance

12.3.1 Yearly maintenance outdoor unit: overview

Check the following at least once a year:

- Heat exchanger
- Water filter

12.3.2 Yearly maintenance outdoor unit: instructions

Heat exchanger

The heat exchanger of the outdoor unit can get blocked up due to dust, dirt, leaves, etc. It is recommended to clean the heat exchanger yearly. A blocked heat exchanger can lead to too low pressure or too high pressure leading to worse performance.

Water filter

Close the valve. Clean and rinse the water filter.



NOTICE

Handle the filter with care. To prevent damage to the mesh of the filter, do NOT use excessive force when you reinsert it.

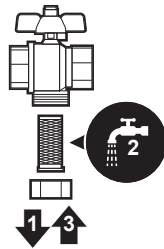

12.3.3 Yearly maintenance indoor unit: overview

- Water pressure
- Magnetic filter/dirt separator
- Water pressure relief valve
- Relief valve hose
- Pressure relief valve of the domestic hot water tank
- Switch box
- Descaling
- Chemical disinfection

12.3.4 Yearly maintenance indoor unit: instructions

Water pressure

Keep water pressure above 1 bar. If it is lower, add water.

Magnetic filter/dirt separator

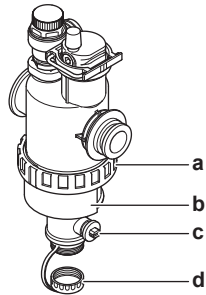

- a Screw connection
- b Magnetic sleeve
- c Drain valve
- d Drain cap

The yearly maintenance of the magnetic filter/dirt separator consists of:

- Checking if both parts of the magnetic filter/dirt separator are still screwed tight (a).
- Emptying the dirt separator as follows:

- 1 Take off the magnetic sleeve (b).
- 2 Unscrew the drain cap (d).
- 3 Connect a drain hose to the bottom of the water filter so that the water and dirt can be collected in a suitable container (bottle, sink...).
- 4 Open the drain valve for a couple of seconds (c).

Result: Water and dirt will come out.

- 5 Close the drain valve.
- 6 Screw the drain cap back on.
- 7 Reattach the magnetic sleeve.
- 8 Check the pressure of the water circuit. If required, add water.



NOTICE

- When checking the magnetic filter/dirt separator for tightness, hold it firmly, so as NOT to apply stress to the water piping.
- Do NOT isolate the magnetic filter/dirt separator by closing the shut-off valves. To properly empty the dirt separator, sufficient pressure is required.
- To prevent dirt from remaining in the dirt separator, ALWAYS take off the magnetic sleeve.
- ALWAYS first unscrew the drain cap, and connect a drain hose to the bottom of the water filter, then open the drain valve.



INFORMATION

For yearly maintenance, you do not have to remove the water filter from the unit to clean it. But in case of trouble with the water filter, you might have to remove it so that you can thoroughly clean it. Then you need to do as follows:

- ["To remove the water filter"](#) [▶ 215]
- ["To clean the water filter in case of trouble"](#) [▶ 215]
- ["To install the water filter"](#) [▶ 216]

Water pressure relief valve

Open the valve and check if it operates correctly. **The water may be very hot!**

Checkpoints are:

- The water flow coming from the relief valve is high enough, no blockage of the valve or in between piping is suspected.
- Dirty water coming out of the relief valve:
 - open the valve until the discharged water does NOT contain dirt anymore
 - flush the system

It is recommended to do this maintenance more frequently.

Pressure relief valve hose

Check whether the pressure relief valve hose is positioned appropriately to drain the water. See "[To connect the drain hose to the drain](#)" [▶ 71].

Pressure relief valve of the domestic hot water tank (field supply)

Open the valve.



CAUTION

Water coming out of the valve may be very hot.

- Check if nothing blocks the water in the valve or in between piping. The water flow coming from the relief valve must be high enough.
- Check if the water coming out of the relief valve is clean. If it contains debris or dirt:
 - Open the valve until the discharged water does not contain debris or dirt anymore.
 - Flush and clean the complete tank, including the piping between the relief valve and cold water inlet.

To make sure this water originates from the tank, check after a tank heat up cycle.



INFORMATION

It is recommended to perform this maintenance more than once a year.

Switch box

- Carry out a thorough visual inspection of the switch box and look for obvious defects such as loose connections or defective wiring.
- Using an ohmmeter, check if contactors K1M, K2M, K3M and K5M (depending on your installation) operate correctly. All contacts of these contactors must be in open position when the power is turned OFF.



WARNING

If the internal wiring is damaged, it has to be replaced by the manufacturer, its service agent or similarly qualified persons.

Descaling

Depending on water quality and set temperature, scale can deposit on the heat exchanger inside the domestic hot water tank and can restrict heat transfer. For this reason, descaling of the heat exchanger may be required at certain intervals.

Chemical disinfection

If the applicable legislation requires a chemical disinfection in specific situations, involving the domestic hot water tank, please be aware that the domestic hot water tank is a stainless steel cylinder. We recommend to use a non-chloride based disinfectant approved for use with water intended for human consumption.



NOTICE

When using means for descaling or chemical disinfection, it must be ensured that the water quality remains compliant with EU directive 98/83 EC.

12.4 To drain the domestic hot water tank



DANGER: RISK OF BURNING/SCALDING

The water in the tank can be very hot.

Prerequisite: Stop the unit operation via the user interface.

Prerequisite: Turn OFF the respective circuit breaker.

Prerequisite: Close the cold water supply.

Prerequisite: Open all the hot water tapping points to allow air to enter the system.

- 1 Remove the top panel, the user interface panel and the front panel.
- 2 Lower the switch box.
- 3 Remove the stop from the access point to the tank.
- 4 Use a drain hose and a pump to drain the tank via the access point.

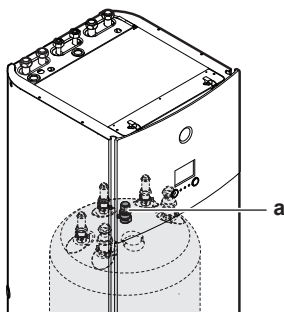

a Access point to the tank

12.5 About cleaning the water filter in case of trouble



INFORMATION

For yearly maintenance, you do not have to remove the water filter from the unit to clean it. But in case of trouble with the water filter, you might have to remove it so that you can thoroughly clean it. Then you need to do as follows:

- "To remove the water filter" [▶ 215]
- "To clean the water filter in case of trouble" [▶ 215]
- "To install the water filter" [▶ 216]

12.5.1 To remove the water filter

Prerequisite: Stop the unit operation via the user interface.

Prerequisite: Turn OFF the respective circuit breaker.

- 1 The water filter is located behind the switch box. To get access to it, see:
 - "To open the indoor unit" [▶ 60]
 - "To lower the switch box on the indoor unit" [▶ 62]
- 2 Close the stop valves of the water circuit.
- 3 Close the valve (if equipped) of the water circuit towards the expansion vessel.
- 4 Remove the cap on the bottom of the magnetic filter/dirt separator.
- 5 Connect a drain hose to the bottom of the water filter.
- 6 Open the valve on the bottom of the water filter to drain water from the water circuit. Collect the drained water in a bottle, sink,... using the installed drain hose.
- 7 Remove the 2 clips that fix the water filter.

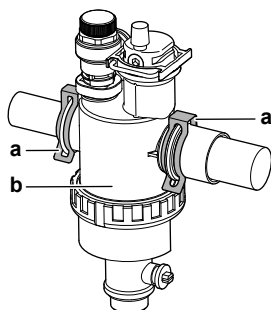

- a Clip
b Magnetic filter/dirt separator

- 8 Remove the water filter.
- 9 Remove the drain hose from the water filter.

**CAUTION**

Although the water circuit is drained, some water may be spilled when removing the magnetic filter/dirt separator from the filter housing. ALWAYS clean up spilled water.

12.5.2 To clean the water filter in case of trouble

- 1 Remove the water filter from the unit. See "To remove the water filter" [▶ 215].

**CAUTION**

To protect the piping connected to the magnetic filter/dirt separator from damage it is recommended to perform this procedure with the magnetic filter/dirt separator removed from the unit.

- 2 Unscrew the bottom of the water filter housing. Use an appropriate tool if needed.

**CAUTION**

Opening the magnetic filter/dirt separator is ONLY required in case of severe issues. Preferably this action is never to be done during the complete lifetime of the magnetic filter/dirt separator.

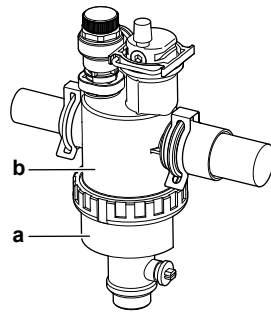

- a Bottom part to be unscrewed
- b Water filter housing

- 3 Remove the strainer and the rolled-up filter from the water filter housing and clean with water.
- 4 Install the cleaned rolled-up filter and strainer in the water filter housing.



INFORMATION

Correctly install the strainer in the magnetic filter/dirt separator housing using the protrusions.

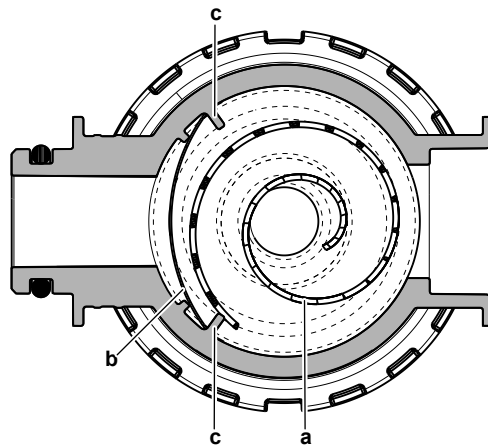

- a Rolled-up filter
- b Strainer
- c Protrusion

- 5 Install and properly tighten the bottom of the water filter housing.

12.5.3 To install the water filter



CAUTION

Check the condition of the O-rings and replace if needed. Apply water to the O-rings before installation.

- 1 Install the water filter in the correct location.

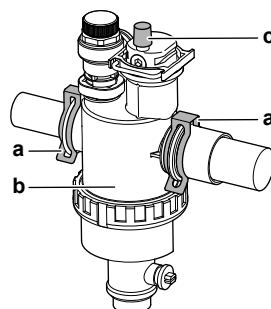

- a Clip
- b Magnetic filter/dirt separator
- c Air purge valve

- 2 Install the 2 clips to fix the water filter to the water circuit pipes.
- 3 Make sure that the air purge valve of the water filter is in the open position.
- 4 Open the valve (if equipped) of the water circuit towards the expansion vessel.

**CAUTION**

Make sure to open the valve (if equipped) towards the expansion vessel, otherwise the overpressure will be generated.

- 5 Open the stop valves and add water to the water circuit if needed.

13 Troubleshooting

Contact

For the symptoms listed below, you can try to solve the problem yourself. For any other problem, contact your installer. You can find the contact/helpdesk number via the user interface.

1	Go to [8.3]: Information > Dealer information.	
----------	--	---

In this chapter

13.1	Overview: Troubleshooting	218
13.2	Precautions when troubleshooting.....	218
13.3	Solving problems based on symptoms.....	219
13.3.1	Symptom: The unit is NOT heating or cooling as expected	219
13.3.2	Symptom: Hot water does NOT reach the desired temperature	220
13.3.3	Symptom: The compressor does NOT start (space heating or domestic water heating)	220
13.3.4	Symptom: The system is making gurgling noises after commissioning.....	220
13.3.5	Symptom: The pump is blocked.....	221
13.3.6	Symptom: The pump is making noise (cavitation)	221
13.3.7	Symptom: The pressure relief valve opens	222
13.3.8	Symptom: The water pressure relief valve leaks.....	222
13.3.9	Symptom: The space is NOT sufficiently heated at low outdoor temperatures	223
13.3.10	Symptom: The pressure at the tapping point is temporarily unusually high	224
13.3.11	Symptom: Tank disinfection function is NOT completed correctly (AH-error)	224
13.4	Solving problems based on error codes.....	224
13.4.1	To display the help text in case of a malfunction.....	225
13.4.2	Error codes: Overview.....	225

13.1 Overview: Troubleshooting

This chapter describes what you have to do in case of problems.

It contains information about:

- Solving problems based on symptoms
- Solving problems based on error codes

Before troubleshooting

Carry out a thorough visual inspection of the unit and look for obvious defects such as loose connections or defective wiring.

13.2 Precautions when troubleshooting



WARNING

- When carrying out an inspection on the switch box of the unit, ALWAYS make sure that the unit is disconnected from the mains. Turn off the respective circuit breaker.
- When a safety device was activated, stop the unit and find out why the safety device was activated before resetting it. NEVER shunt safety devices or change their values to a value other than the factory default setting. If you are unable to find the cause of the problem, call your dealer.



DANGER: RISK OF ELECTROCUTION

**WARNING**

Prevent hazards due to inadvertent resetting of the thermal cut-out: power to this appliance **MUST NOT** be supplied through an external switching device, such as a timer, or connected to a circuit that is regularly turned ON and OFF by the utility.

**DANGER: RISK OF BURNING/SCALDING**

13.3 Solving problems based on symptoms

13.3.1 Symptom: The unit is NOT heating or cooling as expected

Possible causes	Corrective action
The temperature setting is NOT correct	Check the temperature setting on the remote controller. Refer to the operation manual.
The water flow is too low	<p>Check and make sure that:</p> <ul style="list-style-type: none"> ▪ All shut-off valves of the water circuit are completely open. ▪ The water filter is clean. Clean if necessary. ▪ There is no air in the system. Purge air if necessary. You can purge air manually (see "To perform a manual air purge" [▶ 202]) or use the automatic air purge function (see "To perform an automatic air purge" [▶ 203]). ▪ The water pressure is >1 bar. ▪ The expansion vessel is NOT broken. ▪ The valve (if equipped) of the water circuit towards the expansion vessel is open. ▪ The resistance in the water circuit is NOT too high for the pump (see the ESP curve in the "Technical data" chapter). <p>If the problem persists after you have conducted all of the above checks, contact your dealer. In some cases, it is normal that the unit decides to use a low water flow.</p>
The water volume in the installation is too low	Make sure that the water volume in the installation is above the minimum required value (see "To check the water volume and flow rate" [▶ 75]).



13.3.2 Symptom: Hot water does NOT reach the desired temperature

Possible causes	Corrective action
One of the tank temperature sensors is broken.	See the service manual of the unit for the corresponding corrective action.

13.3.3 Symptom: The compressor does NOT start (space heating or domestic water heating)



Possible causes	Corrective action
The compressor cannot start if the water temperature is too low. The unit will use the backup heater to reach the minimum water temperature (12°C), after which the compressor can start.	<p>If the backup heater doesn't start either, check and make sure that:</p> <ul style="list-style-type: none"> ▪ The power supply to the backup heater is correctly wired. ▪ The backup heater thermal protector is NOT activated. ▪ The backup heater contactors are NOT broken. <p>If the problem persists, contact your dealer.</p>
The preferential kWh rate power supply settings and electrical connections do NOT match	<p>This should match with the connections as explained in:</p> <ul style="list-style-type: none"> ▪ "To connect the main power supply" [▶ 101] ▪ "About preferential kWh rate power supply" [▶ 89] ▪ "Overview of electrical connections except external actuators" [▶ 90]
The preferential kWh rate signal was sent by the electricity company	<p>In the user interface of the unit, go to [8.5.B] Information > Actuators > Forced off contact.</p> <p>If Forced off contact is On, the unit is operating under the preferential kWh rate. Wait for the power to return (maximum 2 hours).</p>

13.3.4 Symptom: The system is making gurgling noises after commissioning

Possible cause	Corrective action
There is air in the system.	Purge air from the system. ^(a)
Various malfunctions.	Check if  or  is displayed on the home screen of the user interface. See "To display the help text in case of a malfunction" [▶ 225] for more information about the malfunction.

^(a) We recommend to purge air with the air purge function of the unit (to be performed by the installer). If you purge air from the heat emitters or collectors, mind the following:

**WARNING**

Air purging heat emitters or collectors. Before you purge air from heat emitters or collectors, check if  or  is displayed on the home screen of the user interface.

- If not, you can purge air immediately.
- If yes, make sure that the room where you want to purge air is sufficiently ventilated. **Reason:** Refrigerant might leak into the water circuit, and subsequently into the room when you purge air from the heat emitters or collectors.

13.3.5 Symptom: The pump is blocked

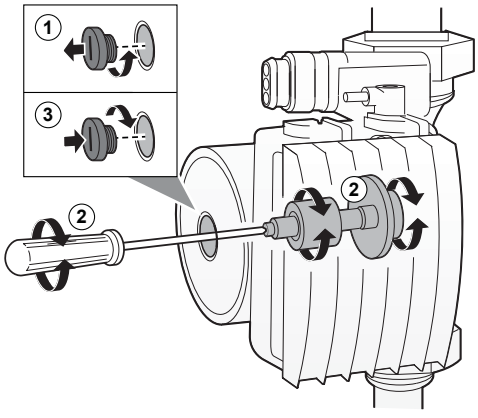
Possible causes	Corrective action
If the unit has been powered off for a long time, lime might block the rotor of the pump.	<p>Remove the screw of the stator housing and use a screwdriver to turn back and forth the ceramic shaft of the rotor until the rotor is deblocked.^(a)</p> <p>Note: Do NOT use excessive force.</p> 

^(a) If you cannot deblock the rotor of the pump with this method, you will need to disassemble the pump and turn the rotor by hand.

13.3.6 Symptom: The pump is making noise (cavitation)

Possible causes	Corrective action
There is air in the system	Purge air manually (see "To perform a manual air purge" [▶ 202]) or use the automatic air purge function (see "To perform an automatic air purge" [▶ 203]).

Possible causes	Corrective action
The water pressure at the pump inlet is too low	<p>Check and make sure that:</p> <ul style="list-style-type: none"> ▪ The water pressure is >1 bar. ▪ The water pressure sensor is not broken. ▪ The expansion vessel is NOT broken. ▪ The valve (if equipped) of the water circuit towards the expansion vessel is open. ▪ The pre-pressure setting of the expansion vessel is correct (see "Changing the pre-pressure of the expansion vessel" [▶ 78]).

13.3.7 Symptom: The pressure relief valve opens

Possible causes	Corrective action
The expansion vessel is broken	Replace the expansion vessel.
The valve (if equipped) of the water circuit towards the expansion vessel is closed.	Open the valve.
The water volume in the installation is too high	Make sure that the water volume in the installation is below the maximum allowed value (see "To check the water volume and flow rate" [▶ 75] and "Changing the pre-pressure of the expansion vessel" [▶ 78]).
The water circuit head is too high	<p>The water circuit head is the difference in height between the indoor unit and the highest point of the water circuit. If the indoor unit is located at the highest point of the installation, the installation height is considered 0 m. The maximum water circuit head is 10 m.</p> <p>Check the installation requirements.</p>

13.3.8 Symptom: The water pressure relief valve leaks

Possible causes	Corrective action
Dirt is blocking the water pressure relief valve outlet	<p>Check whether the pressure relief valve works correctly by turning the red knob on the valve counterclockwise:</p> <ul style="list-style-type: none"> ▪ If you do NOT hear a clacking sound, contact your dealer. ▪ If the water keeps running out of the unit, close both the water inlet and outlet shut-off valves first and then contact your dealer.

13.3.9 Symptom: The space is NOT sufficiently heated at low outdoor temperatures

Possible causes	Corrective action
The backup heater operation is not activated	<p>Check the following:</p> <ul style="list-style-type: none"> ▪ The backup heater operation mode is enabled. Go to: [9.3.8]: Installer settings > Backup heater > Operation [4-00] ▪ The backup heater overcurrent circuit breaker is on. If not, turn it back on. ▪ The thermal protector of the backup heater is NOT activated. If it has, check the following, and then press the reset button in the switch box: <ul style="list-style-type: none"> - The water pressure - Whether there is air in the system - The air purge operation
The backup heater equilibrium temperature has not been configured correctly	<p>Increase the equilibrium temperature to activate the backup heater operation at a higher outdoor temperature. Go to: [9.3.7]: Installer settings > Backup heater > Equilibrium temperature [5-01]</p>
There is air in the system.	<p>Purge air manually or automatically. See the air purge function in the chapter "10 Commissioning" [▶ 199].</p>
Too much heat pump capacity is used for heating domestic hot water	<p>Check if the Space heating priority settings have been configured appropriately:</p> <ul style="list-style-type: none"> ▪ Make sure that the Space heating priority has been enabled. Go to [9.6.1]: Installer settings > Balancing > Space heating priority [5-02] ▪ Increase the "space heating priority temperature" to activate backup heater operation at a higher outdoor temperature. Go to [9.6.3]: Installer settings > Balancing > Priority temperature [5-03]

13.3.10 Symptom: The pressure at the tapping point is temporarily unusually high

Possible causes	Corrective action
Failing or blocked pressure relief valve.	<ul style="list-style-type: none"> Flush and clean the complete tank including the piping between pressure relief valve and the cold water inlet. Replace the pressure relief valve.

13.3.11 Symptom: Tank disinfection function is NOT completed correctly (AH-error)

Possible causes	Corrective action
The disinfection function was interrupted by domestic hot water tapping	Program the start-up of the disinfection function when the coming 4 hours NO domestic hot water tapping is expected.
Large domestic hot water tapping happened recently before the programmed start-up of the disinfection function	<p>If in [5.6] Tank > Heat up mode the mode Reheat only or Schedule + reheat is selected, it is recommended to program the start-up of the disinfection function at least 4 hours later than the last expected large hot water tapping. This start-up can be set by installer settings (disinfection function).</p> <p>If in [5.6] Tank > Heat up mode the mode Schedule only is selected, it is recommended to program a Eco action 3 hours before the scheduled start-up of the disinfection function to preheat the tank.</p>
The disinfection operation was stopped manually: [C.3] Operation > Tank was turned off during disinfection.	Do NOT stop tank operation during disinfection.

13.4 Solving problems based on error codes

If the unit runs into a problem, the user interface displays an error code. It is important to understand the problem and to take measures before resetting an error code. This should be done by a licensed installer or by your local dealer.

This chapter gives you an overview of most possible error codes and their descriptions as they appear on the user interface.



**INFORMATION**

See the service manual for:

- The complete list of error codes
- A more detailed troubleshooting guideline for each error

13.4.1 To display the help text in case of a malfunction

In case of a malfunction, the following will appear on the home screen depending on the severity:



















- : Error
- : Malfunction

You can get a short and a long description of the malfunction as follows:































1	Press the left dial to open the main menu and go to Malfunctioning . Result: A short description of the error and the error code is displayed on the screen.	
2	Press ? in the error screen. Result: A long description of the error is displayed on the screen.	?













13.4.2 Error codes: Overview

Error codes of the unit

Error code	Description	
7H-01		Water flow problem
7H-04		Water flow problem during domestic hot water production
7H-05		Water flow problem during heating/sampling
7H-06		Water flow problem during cooling/defrost
80-01		Returning water temperature sensor problem
81-00		Leaving water temperature sensor problem
81-01		Mixed water thermistor abnormality.
81-06		Entering water temperature thermistor abnormality (indoor unit)
89-01		Heat exchanger frozen (during defrost)
89-02		Heat exchanger frozen (not during defrost)
89-03		Heat exchanger frozen (during defrost)
8F-00		Abnormal increase outlet water temperature (DHW)
8H-00		Abnormal increase outlet water temperature
8H-01		Overheating mixed water circuit
8H-02		Overheating mixed water circuit (thermostat)
8H-03		Overheating water circuit (thermostat)
A1-00		Zero cross detection problem
A5-00		OU: High pressure peak cut / freeze protection problem

Error code	Description	
AA-01		Backup heater overheated
AC-00		Booster heater overheated
AH-00		Tank disinfection function not completed correctly
AJ-03		Too long DHW heat-up time required
C0-00		Flow sensor malfunction
C4-00		Heat exchanger temperature sensor problem
C5-00		Heat exchanger thermistor abnormality
CJ-02		Room temperature sensor problem
E1-00		OU: PCB defect
E2-00		Leakage current detection error
E3-00		OU: Actuation of high pressure switch (HPS)
E3-24		High pressure switch abnormality
E4-00		Abnormal suction pressure
E5-00		OU: Overheat of inverter compressor motor
E6-00		OU: Compressor startup defect
E7-00		OU: Malfunction of outdoor unit fan motor
E8-00		OU: Power input overvoltage
E9-00		Malfunction of electronic expansion valve
EA-00		OU: Cool/heat switchover problem
EC-00		Abnormal increase tank temperature
EC-04		Tank preheating
F3-00		OU: Malfunction of discharge pipe temperature
F6-00		OU: Abnormal high pressure in cooling
FA-00		OU: Abnormal high pressure, actuation of HPS
H0-00		OU: Voltage/current sensor problem
H1-00		External temperature sensor problem
H3-00		OU: Malfunction of high pressure switch (HPS)
H4-00		Malfunction of low pressure switch
H5-00		Malfunction of compressor overload protection
H6-00		OU: Malfunction of position detection sensor
H8-00		OU: Malfunction of compressor input (CT) system
H9-00		OU: Malfunction of outdoor air thermistor

Error code	Description	
HC-00		Tank temperature sensor problem
HC-01		Second tank temperature sensor problem
HJ-10		Water pressure sensor abnormality
J3-00		OU: Malfunction of discharge pipe thermistor
J3-10		Compressor port thermistor abnormality
J5-00		Malfunction of suction pipe thermistor
J6-00		OU: Malfunction of heat exchanger thermistor
J6-07		OU: Malfunction of heat exchanger thermistor
J6-32		Leaving water temperature thermistor Abnormality (outdoor unit)
J6-33		Sensor communication error
J8-00		Malfunction of refrigerant liquid thermistor
JA-00		OU: Malfunction of high pressure sensor
JC-00		Low pressure sensor abnormality
JC-01		Evaporator pressure abnormality
L1-00		Malfunction of INV PCB
L3-00		OU: Electrical box temperature rise problem
L4-00		OU: Malfunction of inverter radiating fin temperature rise
L5-00		OU: Inverter instantaneous overcurrent (DC)
L8-00		Malfunction triggered by a thermal protection in the inverter PCB
L9-00		Prevention of compressor lock
LC-00		Malfunction in communication system of outdoor unit
P1-00		Open-phase power supply imbalance
P3-00		Abnormal direct current
P4-00		OU: Malfunction of radiating fin temperature sensor
PJ-00		Capacity setting mismatch
U0-00		OU: Shortage of refrigerant
U1-00		Malfunction by reverse phase/open-phase
U2-00		OU: Defect of power supply voltage
U3-00		Underfloor heating screed dryout function not completed correctly
U4-00		Indoor/outdoor unit communication problem

Error code	Description	
U5-00		User interface communication problem
U7-00		OU: Transmission malfunction between main CPU-INV CPU
U8-01		Connection with LAN adapter lost
U8-02		Connection with room thermostat lost
U8-03		No connection with room thermostat
U8-04		Unknown USB device
U8-05		File malfunction
U8-07		P1P2 communication error
UA-00		Indoor unit, outdoor unit matching problem
UA-16		Extension/hydro communication problem
UA-17		Tank type problem
UA-21		Extension/hydro mismatch problem
UF-00		Reversed piping or bad communication wiring detection



INFORMATION

In case of error code AH and no interruption of the disinfection function occurred due to domestic hot water tapping, following actions are recommended:

- When the **Reheat only** or **Schedule + reheat** mode is selected, it is recommended to program the start-up of the disinfection function at least 4 hours later than the last expected large hot water tapping. This start-up can be set by installer settings (disinfection function).
- When the **Schedule only** mode is selected, it is recommended to program an **Eco** action 3 hours before the scheduled start-up of the disinfection function to preheat the tank.



NOTICE

When the minimum water flow is lower than described in the table below, the unit will temporarily stop operation and the user interface will display error 7H-01. After some time, this error will reset automatically and the unit will resume operation.

Minimum required flow rate

25 l/min



INFORMATION

Error AJ-03 is reset automatically from the moment there is a normal tank heat-up.



INFORMATION

If an U8-04 error occurs, the error can be reset after a successful update of the software. If the software is not successfully updated then you must make sure that your USB device has the FAT32 format.

**INFORMATION**

The user interface will display how to reset an error code.

14 Disposal



NOTICE

Do NOT try to dismantle the system yourself: dismantling of the system, treatment of the refrigerant, oil and other parts MUST comply with applicable legislation. Units MUST be treated at a specialised treatment facility for reuse, recycling and recovery.

In this chapter

14.1 To recover refrigerant 230

14.1 To recover refrigerant

When disposing of the outdoor unit, you need to recover its refrigerant.

- Use the service port (**a**) to recover refrigerant.
- Make sure the valves (**Y1E**, **Y3E**, **Y2S**, **Y3S**, **Y4S**) are open. If they are not open during refrigerant recovery, refrigerant remains trapped in the unit.

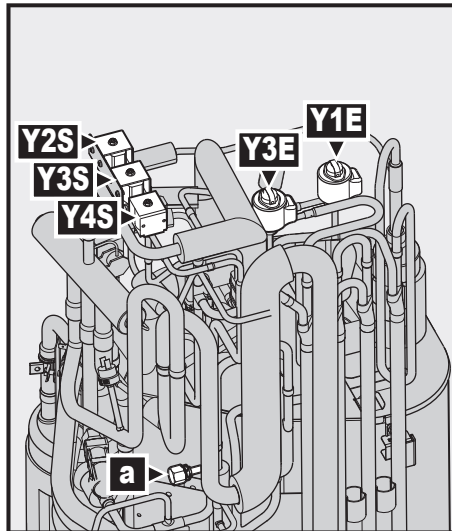

- a** Service port 5/16" flare
- Y1E** Electronic expansion valve (main)
- Y3E** Electronic expansion valve (injection)
- Y2S** Solenoid valve (low pressure bypass)
- Y3S** Solenoid valve (hot gas bypass)
- Y4S** Solenoid valve (liquid injection)

To open the valves when power is ON



WARNING

Rotating fan. Before powering ON or servicing the outdoor unit, make sure that the discharge grille covers the fan as protection against a rotating fan. See:

- "To install the discharge grille" ▶ 67
- "To remove the discharge grille, and put the grille in safety position" ▶ 68]

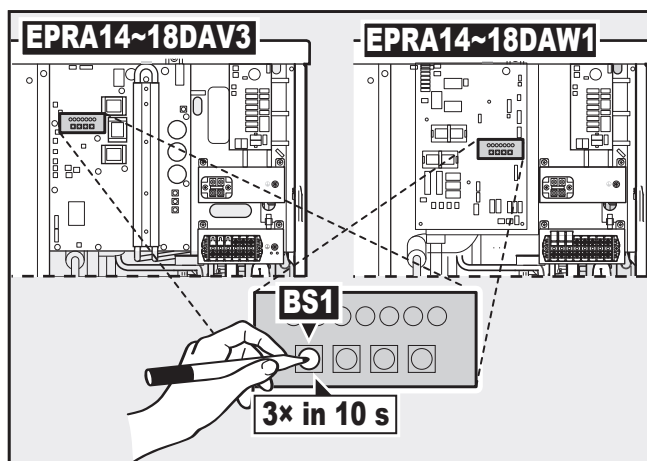

a Push button

- 1 Make sure the unit is not running.
- 2 Activate the vacuum/recovery mode by pushing **BS1** 3 times within 10 seconds. To push **BS1**, use an insulated stick (such as a closed ballpoint pen) to prevent touching of live parts.

Result: The unit opens all necessary valves.

- 3 After recovering refrigerant, deactivate the vacuum/recovery mode by pushing **BS1** 3 times within 10 seconds.

To open the valves when power is OFF

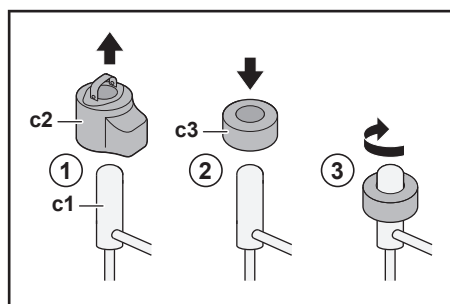

c1 Electronic expansion valve / Solenoid valve
c2 EEV coil
c3 EEV magnet

- 1 Remove the EEV coil (**c2**).
- 2 Slide an EEV magnet (**c3**) over the expansion valve / solenoid valve (**c1**).
- 3 Turn the EEV magnet clockwise to the fully open position of the valve. If you are not sure about what the open position is, turn the valve in its middle position so that refrigerant can pass.

15 Technical data

A **subset** of the latest technical data is available on the regional Daikin website (publicly accessible). The **full set** of latest technical data is available on the Daikin Business Portal (authentication required).

In this chapter

15.1	Service space: Outdoor unit	233
15.2	Piping diagram: Outdoor unit.....	234
15.3	Piping diagram: Indoor unit.....	235
15.4	Wiring diagram: Outdoor unit	236
15.5	Wiring diagram: Indoor unit.....	241

15.1 Service space: Outdoor unit

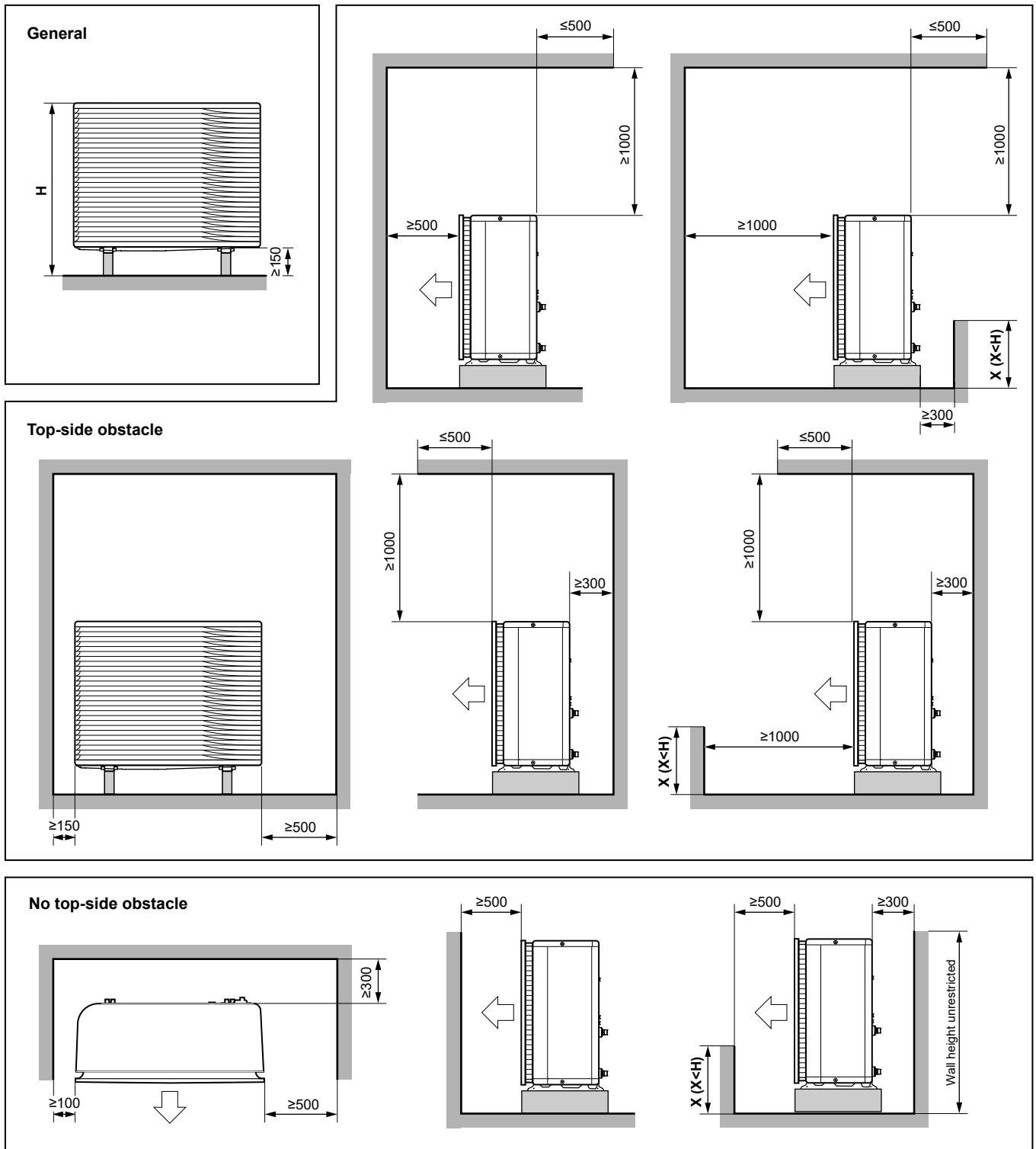

(mm)

3D124412

English	Translation
General	General
No top-side obstacle	No top-side obstacle
Top-side obstacle	Top-side obstacle
Wall height unrestricted	Wall height unrestricted

15.2 Piping diagram: Outdoor unit

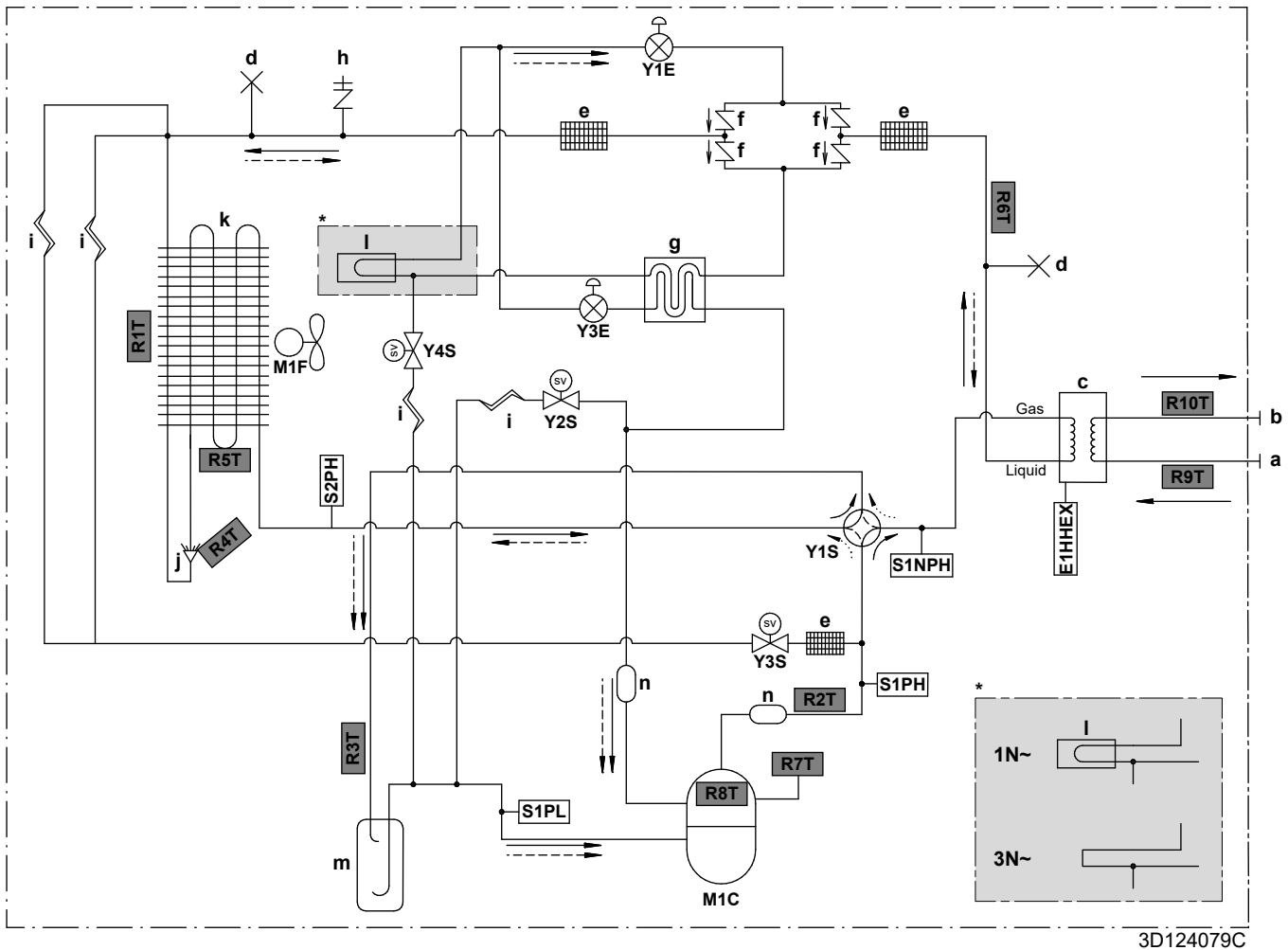

3D124079C

- Gas** Gas
- Liquid** Liquid
- a** Water IN (screw connection, male, 1")
- b** Water OUT (screw connection, male, 1")
- c** Plate heat exchanger
- d** Pinched pipe
- e** Refrigerant filter
- f** One-way valve
- g** Economiser heat exchanger
- h** Service port 5/16" flare
- i** Capillary tube
- j** Distributor
- k** Air heat exchanger
- l** PCB cooling
- m** Accumulator
- n** Muffler
- E1HHEX** Plate heat exchanger heater
- M1C** Compressor
- M1F** Fan motor
- S1PH** High pressure switch (5.6 MPa)
- S2PH** High pressure switch (4.17 MPa)
- S1PL** Low pressure switch
- S1NPH** High pressure sensor
- Y1E** Electronic expansion valve (main)
- Y3E** Electronic expansion valve (injection)
- Y1S** Solenoid valve (4-way valve)
- Y2S** Solenoid valve (low pressure bypass)
- Y3S** Solenoid valve (hot gas bypass)
- Y4S** Solenoid valve (liquid injection)



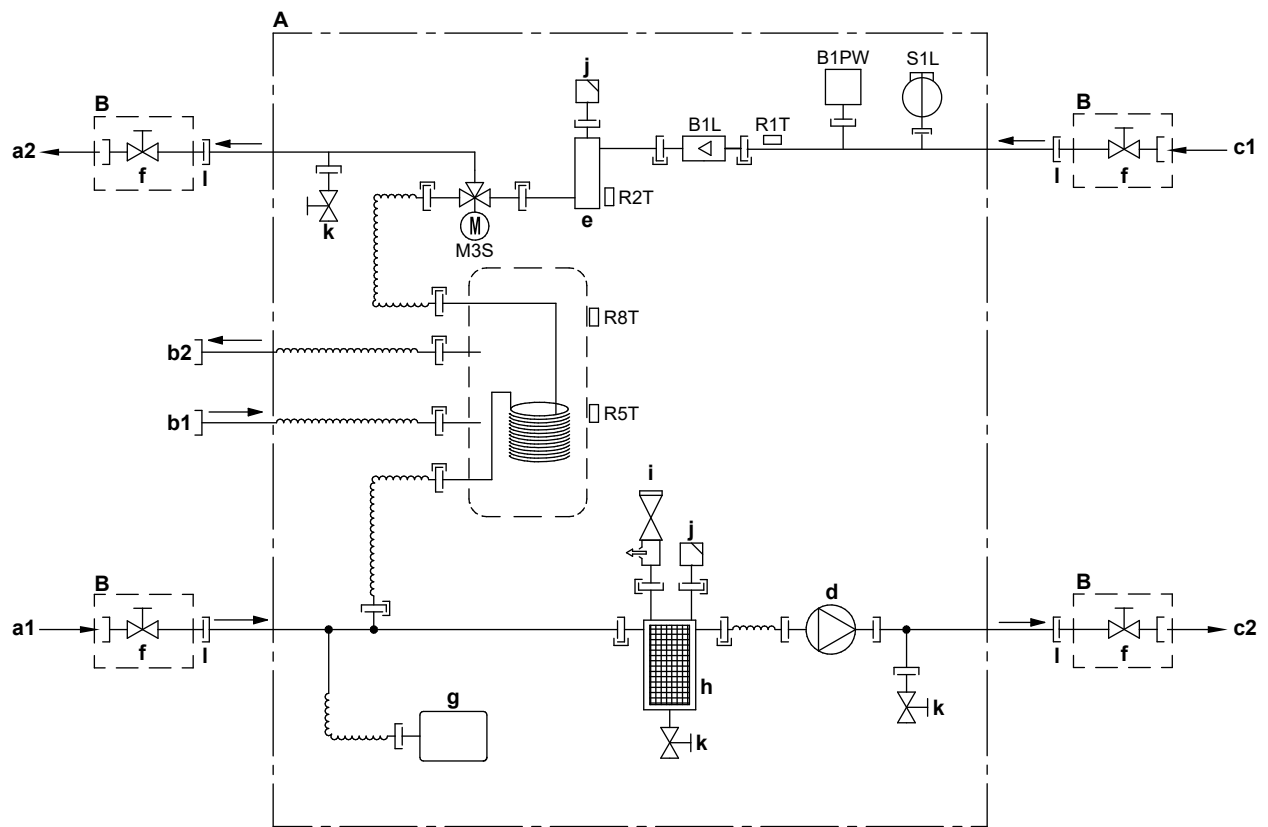

- Thermistors:**
- R1T** Outdoor air
- R2T** Compressor discharge
- R3T** Compressor suction
- R4T** Air heat exchanger, distributor
- R5T** Air heat exchanger, middle
- R6T** Refrigerant liquid
- R7T** Compressor shell
- R8T** Compressor port
- R9T** Entering water
- R10T** Leaving water

- Refrigerant flow:**
- ➔ Heating
- ➔➔ Cooling

15.3 Piping diagram: Indoor unit



3D120611A









- A** Indoor unit
B Field installed
a1 Space heating/cooling – Water IN (screw connection, 1")
a2 Space heating/cooling – Water OUT (screw connection, 1")
b1 DHW – Cold water IN (screw connection, 3/4")
b2 DHW – Hot water OUT (screw connection, 3/4")
c1 Water IN from outdoor unit (screw connection, 1")
c2 Water OUT to outdoor unit (screw connection, 1")
d Pump
e Backup heater
f Shut-off valve, male-female 1"
g Expansion vessel
h Magnetic filter/dirt separator
i Safety valve
j Air purge
k Drain valve
l Loose nut 1"
B1L Flow sensor
B1PW Space heating water pressure sensor
M3S 3-way valve (space heating/domestic hot water)
R1T Thermistor (water IN)
R2T Thermistor (backup heater – water OUT)
R5T, R8T Thermistor (tank)
S1L Flow switch
 Screw connection
 Flare connection
 Quick coupling
 Brazed connection

15.4 Wiring diagram: Outdoor unit

The wiring diagram is delivered with the unit, located at the inside of the switch box cover.

English	Translation
Electronic component assembly	Electronic component assembly
Front side view	Front side view
Indoor	Indoor
OFF	OFF
ON	ON
Outdoor	Outdoor
Position of compressor terminal	Position of compressor terminal
Position of elements	Position of elements
Rear side view	(only for W1 models) Rear side view
Right side view	Right side view
See note ***	See note ***

Notes:

1	Symbols:	
	L	Live
	N	Neutral
		Protective earth
		Noiseless earth
		Field wiring
		Option
		Terminal strip
		Terminal
		Connector
	Connection	

2	Colours:	
	BLK	Black
	RED	Red
	BLU	Blue
	WHT	White
	GRN	Green
	YLW	Yellow
	PNK	Pink
	ORG	Orange
	GRY	Grey
BRN	Brown	
3	This wiring diagram applies only to the outdoor unit.	
4	When operating, do not short-circuit protective devices S1PH, S2PH and S1PL.	
5	Refer to the combination table and the option manual for how to connect the wiring to X6A, X41A and X2M.	
6	The factory setting of all switches is OFF, do not change the setting of the selector switch (DS1).	
7	(only for W1 models) Ferrite core Z8C consists of 2 separate core parts.	

Legend in case of V3 models:

A1P	Printed circuit board (main)
A2P	Printed circuit board (noise filter)
A3P	Printed circuit board (leakage current)
A4P	Printed circuit board (ACS)
A5P	Printed circuit board (flash)
BS1~BS4 (A1P)	Push button switch
C1~C4 (A1P, A2P)	Capacitor
DS1 (A1P)	DIP switch
E1H	Drain tube heater (field supply)
E1HHEX~E3HHEX	Plate heat exchanger heaters
F1U	Field fuse (field supply)
F1U~F4U (A2P)	Fuse
F6U (A1P)	Fuse (T 5.0 A / 250 V)
H1P~H7P (A1P)	Light-emitting diode (service monitor is orange)
HAP (A1P)	Light-emitting diode (service monitor is green)
K1R (A1P)	Magnetic relay (Y1S)
K1R (A4P)	Magnetic relay (E1HHEX~E3HHEX)
K2R (A1P)	Magnetic relay (Y2S)

K2R (A4P)	Magnetic relay (E1H)
K3R (A1P)	Magnetic relay (Y3S)
K4R (A1P)	Magnetic relay (E1HC)
K10R (A1P)	Magnetic relay
K11M (A1P)	Magnetic contactor
K13R~K15R (A1P, A2P)	Magnetic relay
L1R~L3R (A1P)	Reactor
M1C	Compressor motor
M1F	Fan motor
PS (A1P)	Switching power supply
Q1DI	Earth leakage circuit breaker (30 mA) (field supply)
R1~R5 (A1P, A2P)	Resistor
R1T	Thermistor (outdoor air)
R2T	Thermistor (compressor discharge)
R3T	Thermistor (compressor suction)
R4T	Thermistor (air heat exchanger, distributor)
R5T	Thermistor (air heat exchanger, middle)
R6T	Thermistor (refrigerant liquid)
R7T	Thermistor (compressor shell)
R8T	Thermistor (compressor port)
R9T	Thermistor (entering water)
R10T	Thermistor (leaving water)
R11T	Thermistor (fin)
RC (A2P)	Signal receiver circuit
S1NPH	High pressure sensor
S1PH, S2PH	High pressure switch
S1PL	Low pressure switch
T1A	Current transfo
TC (A2P)	Signal transmission circuit
V1D~V4D (A1P)	Diode
V1R (A1P)	IGBT power module
V2R (A1P)	Diode module
V1T~V3T (A1P)	Insulated Gate Bipolar Transistor (IGBT)
X1M, X2M	Terminal strip
Y1E	Electronic expansion valve (main)
Y3E	Electronic expansion valve (injection)
Y1S	Solenoid valve (4-way valve)
Y2S	Solenoid valve (low pressure bypass)

Y3S	Solenoid valve (hot gas bypass)
Y4S	Solenoid valve (liquid injection)
Z1C~Z11C	Noise filter (ferrite core)
Z1F~Z6F (A1P, A2P)	Noise filter

Legend in case of W1 models:

A1P	Printed circuit board (main)
A2P	Printed circuit board (noise filter)
A3P	Printed circuit board (leakage current)
A4P	Printed circuit board (ACS)
A5P	Printed circuit board (inverter)
BS1~BS4 (A1P)	Push button switch
C1~C3 (A2P)	Capacitor
DS1 (A1P)	DIP switch
E1H	Drain tube heater (field supply)
E1HHEX	Plate heat exchanger heater
F1U	Field fuse (field supply)
F1U~F7U (A1P, A2P)	Fuse
H1P~H7P (A1P)	Light-emitting diode (service monitor is orange)
HAP (A1P, A2P)	Light-emitting diode (service monitor is green)
K1R (A1P)	Magnetic relay (Y1S)
K1R (A2P)	Magnetic relay
K1R (A4P)	Magnetic relay (E1HHEX)
K2R (A1P)	Magnetic relay (Y2S)
K2R (A4P)	Magnetic relay (E1H)
K3R (A1P)	Magnetic relay (Y3S)
K4R (A1P)	Magnetic relay (E1HC)
K2M, K11M (A2P)	Magnetic contactor
L1R~L4R	Reactor
M1C	Compressor motor
M1F	Fan motor
PS (A2P)	Switching power supply
Q1DI	Earth leakage circuit breaker (30 mA) (field supply)
R1, R2 (A2P)	Resistor
R1T	Thermistor (outdoor air)
R2T	Thermistor (compressor discharge)
R3T	Thermistor (compressor suction)
R4T	Thermistor (air heat exchanger, distributor)
R5T	Thermistor (air heat exchanger, middle)

R6T	Thermistor (refrigerant liquid)
R7T	Thermistor (compressor shell)
R8T	Thermistor (compressor port)
R9T	Thermistor (entering water)
R10T	Thermistor (leaving water)
R11T	Thermistor (fin)
S1NPH	High pressure sensor
S1PH, S2PH	High pressure switch
S1PL	Low pressure switch
T1A	Current transfo
V1R, V2R (A2P)	IGBT power module
V3R (A2P)	Diode module
X1M, X2M	Terminal strip
Y1E	Electronic expansion valve (main)
Y3E	Electronic expansion valve (injection)
Y1S	Solenoid valve (4-way valve)
Y2S	Solenoid valve (low pressure bypass)
Y3S	Solenoid valve (hot gas bypass)
Y4S	Solenoid valve (liquid injection)
Z1C~Z10C	Noise filter (ferrite core)
Z1F~Z4F (A1P, A3P)	Noise filter

15.5 Wiring diagram: Indoor unit

See the internal wiring diagram supplied with the unit (on the inside of the indoor unit switch box cover). The abbreviations used are listed below.

Notes to go through before starting the unit

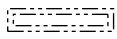
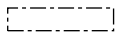
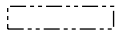
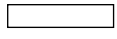
English	Translation
Notes to go through before starting the unit	Notes to go through before starting the unit
X1M	Main terminal
X2M	Field wiring terminal for AC
X5M	Field wiring terminal for DC
X6M	Backup heater power supply terminal
-----	Earth wiring
-----	Field supply
①	Several wiring possibilities
	Option
	Not mounted in switch box
	Wiring depending on model
	PCB
Note 1: Connection point of the power supply for the BUH should be foreseen outside the unit.	Note 1: Connection point of the power supply for the backup heater should be foreseen outside the unit.
Backup heater power supply	Backup heater power supply
<input type="checkbox"/> 6T1 (3~, 230 V, 6 kW)	<input type="checkbox"/> 6T1 (3~, 230 V, 6 kW)
<input type="checkbox"/> 6V (1N~, 230 V, 6 kW)	<input type="checkbox"/> 6V (1N~, 230 V, 6 kW)
<input type="checkbox"/> 6WN/9WN (3N~, 400 V, 6/9 kW)	<input type="checkbox"/> 6WN/9WN (3N~, 400 V, 6/9 kW)
User installed options	User installed options
<input type="checkbox"/> LAN adapter	<input type="checkbox"/> LAN adapter
<input type="checkbox"/> WLAN adapter	<input type="checkbox"/> WLAN adapter
<input type="checkbox"/> Remote user interface	<input type="checkbox"/> Dedicated Human Comfort Interface (BRC1HHDA used as room thermostat)
<input type="checkbox"/> Ext. indoor thermistor	<input type="checkbox"/> External indoor thermistor
<input type="checkbox"/> Ext outdoor thermistor	<input type="checkbox"/> External outdoor thermistor
<input type="checkbox"/> Digital I/O PCB	<input type="checkbox"/> Digital I/O PCB
<input type="checkbox"/> Demand PCB	<input type="checkbox"/> Demand PCB
<input type="checkbox"/> Safety thermostat	<input type="checkbox"/> Safety thermostat
Main LWT	Main leaving water temperature
<input type="checkbox"/> On/OFF thermostat (wired)	<input type="checkbox"/> On/OFF thermostat (wired)
<input type="checkbox"/> On/OFF thermostat (wireless)	<input type="checkbox"/> On/OFF thermostat (wireless)
<input type="checkbox"/> Ext. thermistor	<input type="checkbox"/> External thermistor

English	Translation
<input type="checkbox"/> Heat pump convector	<input type="checkbox"/> Heat pump convector
Add LWT	Additional leaving water temperature
<input type="checkbox"/> On/OFF thermostat (wired)	<input type="checkbox"/> On/OFF thermostat (wired)
<input type="checkbox"/> On/OFF thermostat (wireless)	<input type="checkbox"/> On/OFF thermostat (wireless)
<input type="checkbox"/> Ext. thermistor	<input type="checkbox"/> External thermistor
<input type="checkbox"/> Heat pump convector	<input type="checkbox"/> Heat pump convector

Position in switch box

English	Translation
Position in switch box	Position in switch box
SWB1	Upper switch box
SWB2	Lower switch box

Legend

A1P		Main PCB
A2P	*	On/OFF thermostat (PC=power circuit)
A3P	*	Heat pump convector
A4P	*	Digital I/O PCB
A8P	*	Demand PCB
A11P		MMI (= user interface of the indoor unit) – Main PCB
A13P	*	LAN adapter
A14P	*	PCB of the dedicated Human Comfort Interface (BRC1HHDA used as room thermostat)
A15P	*	Receiver PCB (wireless On/OFF thermostat)
A20P	*	WLAN adapter
CN* (A4P)	*	Connector
DS1(A8P)	*	DIP switch
F1B	#	Overcurrent fuse backup heater
F1U, F2U (A4P)	*	Fuse 5 A 250 V for digital I/O PCB
K1M, K2M		Contactors backup heater
K5M		Safety contactor backup heater
K*R (A4P)		Relay on PCB
M2P	#	Domestic hot water pump
M2S	#	2-way valve for cooling mode
PC (A15P)	*	Power circuit
PHC1 (A4P)	*	Optocoupler input circuit
Q1L		Thermal protector backup heater
Q4L	#	Safety thermostat
Q*DI	#	Earth leakage circuit breaker

R1H (A2P)	*	Humidity sensor
R1T (A2P)	*	Ambient sensor On/OFF thermostat
R2T (A2P)	*	External sensor (floor or ambient)
R6T	*	External indoor or outdoor ambient thermistor
S1S	#	Preferential kWh rate power supply contact
S2S	#	Electricity meter pulse input 1
S3S	#	Electricity meter pulse input 2
S6S~S9S	*	Digital power limitation inputs
SS1 (A4P)	*	Selector switch
TR1		Power supply transformer
X6M	#	Backup heater power supply terminal strip
X*, X*A, X*Y, Y*		Connector
X*M		Terminal strip

* Optional
Field supply

Translation of text on wiring diagram

English	Translation
(1) Main power connection	(1) Main power connection
For preferential kWh rate power supply	For preferential kWh rate power supply
Indoor unit supplied from outdoor	Indoor unit supplied from outdoor
Normal kWh rate power supply	Normal kWh rate power supply
Only for normal power supply (standard)	Only for normal power supply (standard)
Only for preferential kWh rate power supply (outdoor)	Only for preferential kWh rate power supply (outdoor)
Outdoor unit	Outdoor unit
Preferential kWh rate power supply contact: 16 V DC detection (voltage supplied by PCB)	Preferential kWh rate power supply contact: 16 V DC detection (voltage supplied by PCB)
SWB1	Switch box
Use normal kWh rate power supply for indoor unit	Use normal kWh rate power supply for indoor unit
(2) Backup heater power supply	(2) Backup heater power supply
Only for ***	Only for ***
(3) User interface	(3) User interface
Only for LAN adapter	Only for the LAN adapter
Only for remote user interface HCI	Only for the dedicated Human Comfort Interface (BRC1HHDA used as room thermostat)
Only for WLAN adapter	Only for WLAN adapter
SWB1	Switch box

English	Translation
(5) Ext. thermistor	(5) External thermistor
SWB1	Switch box
(6) Field supplied options	(6) Field supplied options
12 V DC pulse detection (voltage supplied by PCB)	12 V DC pulse detection (voltage supplied by PCB)
230 V AC supplied by PCB	230 V AC supplied by PCB
Continuous	Continuous current
DHW pump output	Domestic hot water pump output
DHW pump	Domestic hot water pump
Electrical meters	Electricity meters
For safety thermostat	For safety thermostat
Inrush	Inrush current
Max. load	Maximum load
Normally closed	Normally closed
Normally open	Normally open
Safety thermostat contact: 16 V DC detection (voltage supplied by PCB)	Safety thermostat contact: 16 V DC detection (voltage supplied by PCB)
Shut-off valve	Shut-off valve
SWB1	Switch box
(7) Option PCBs	(7) Option PCBs
Alarm output	Alarm output
Changeover to ext. heat source	Changeover to external heat source
Max. load	Maximum load
Min. load	Minimum load
Only for demand PCB option	Only for demand PCB option
Only for digital I/O PCB option	Only for digital I/O PCB option
Options: ext. heat source output, alarm output	Options: external heat source output, alarm output
Options: On/OFF output	Options: On/OFF output
Power limitation digital inputs: 12 V DC / 12 mA detection (voltage supplied by PCB)	Power limitation digital inputs: 12 V DC / 12 mA detection (voltage supplied by PCB)
Space C/H On/OFF output	Space cooling/heating On/OFF output
SWB	Switch box
(8) External On/OFF thermostats and heat pump convector	(8) External On/OFF thermostats and heat pump convector
Additional LWT zone	Additional leaving water temperature zone
Main LWT zone	Main leaving water temperature zone

English	Translation
Only for external sensor (floor/ambient)	Only for external sensor (floor or ambient)
Only for heat pump convector	Only for heat pump convector
Only for wired On/OFF thermostat	Only for wired On/OFF thermostat
Only for wireless On/OFF thermostat	Only for wireless On/OFF thermostat

Electrical connection diagram

For more details, please check the unit wiring.

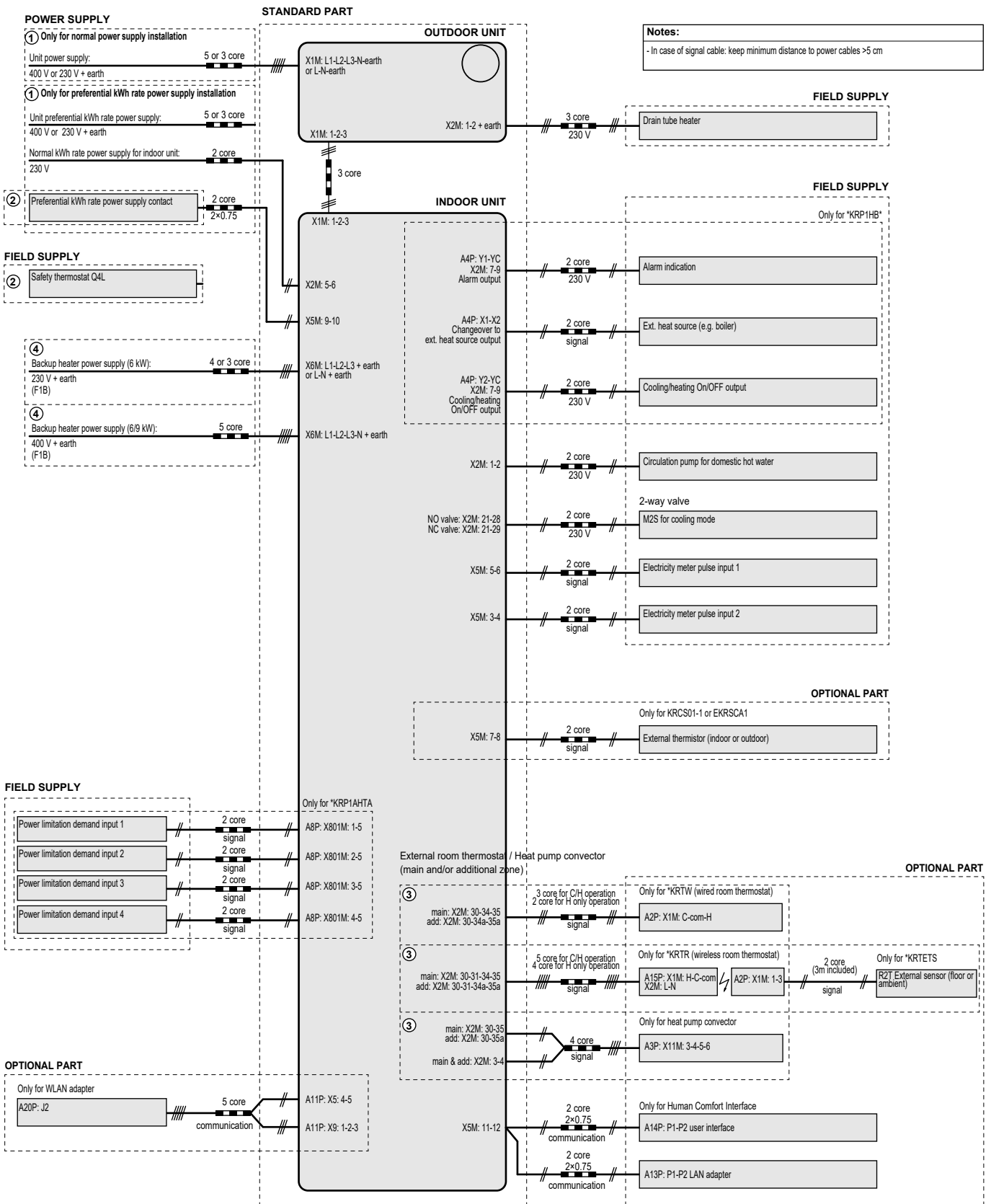

4D124705A

16 Glossary

Dealer

Sales distributor for the product.

Authorised installer

Technical skilled person who is qualified to install the product.

User

Person who is owner of the product and/or operates the product.

Applicable legislation

All international, European, national and local directives, laws, regulations and/or codes that are relevant and applicable for a certain product or domain.

Service company

Qualified company which can perform or coordinate the required service to the product.

Installation manual

Instruction manual specified for a certain product or application, explaining how to install, configure and maintain it.

Operation manual

Instruction manual specified for a certain product or application, explaining how to operate it.

Maintenance instructions

Instruction manual specified for a certain product or application, which explains (if relevant) how to install, configure, operate and/or maintain the product or application.

Accessories

Labels, manuals, information sheets and equipment that are delivered with the product and that need to be installed according to the instructions in the accompanying documentation.

Optional equipment

Equipment made or approved by Daikin that can be combined with the product according to the instructions in the accompanying documentation.

Field supply

Equipment NOT made by Daikin that can be combined with the product according to the instructions in the accompanying documentation.

Field settings table[8.7.5] = **95D1****Applicable indoor units**

ETBH16DA6V
ETBH16DA9W
ETBX16DA6V
ETBX16DA9W
ETBH16DF6V
ETBH16DF9W
ETBX16DF6V
ETBX16DF9W
ETVH16S18DA6V*
ETVH16S23DA6V*
ETVH16S18DA9W*
ETVH16S23DA9W*
ETVX16S18DA6V*
ETVX16S23DA6V*
ETVX16S18DA9W*
ETVX16S23DA9W*

Notes

- (*1) *6V
- (*2) *9W
- (*3) ETB*
- (*4) ETV*
- (*5) *X*
- (*6) *H*

Field settings table				Installer setting at variance with default value		
Breadcrumb	Field code	Setting name	Range, step	Default value	Date	Official Value
Room						
└ Antifrost						
1.4.1	[2-06]	Activation	R/W	0: Disabled 1: Enabled		
1.4.2	[2-05]	Room setpoint	R/W	4-16°C, step: 1°C 8°C		
└ Setpoint range						
1.5.1	[3-07]	Heating minimum	R/W	12-18°C, step: 0,5°C 12°C		
1.5.2	[3-06]	Heating maximum	R/W	18-30°C, step: 0,5°C 30°C		
1.5.3	[3-09]	Cooling minimum	R/W	15-25°C, step: 0,5°C 15°C		
1.5.4	[3-08]	Cooling maximum	R/W	25-35°C, step: 0,5°C 35°C		
Room						
1.6	[2-09]	Room sensor offset	R/W	-5-5°C, step: 0,5°C 0°C		
1.7	[2-0A]	Room sensor offset	R/W	-5-5°C, step: 0,5°C 0°C		
Main zone						
2.4		Setpoint mode		0: Fixed 1: WD heating, fixed cooling 2: Weather dependent		
└ Heating WD curve						
2.5	[1-00]	Low ambient temp. for LWT main zone heating WD curve.	R/W	-40-5°C, step: 1°C -15°C		
2.5	[1-01]	High ambient temp. for LWT main zone heating WD curve.	R/W	10-25°C, step: 1°C 15°C		
2.5	[1-02]	Leaving water value for low ambient temp. for LWT main zone heating WD curve.	R/W	[9-01]-[9-00], step: 1°C [2-0C]=0 35°C [2-0C]=1 45°C [2-0C]=2 65°C		
2.5	[1-03]	Leaving water value for high ambient temp. for LWT main zone heating WD curve.	R/W	[9-01]-min(45, [9-00])°C, step: 1°C [2-0C]=0 25°C [2-0C]=1 35°C [2-0C]=2 35°C		
└ Cooling WD curve						
2.6	[1-06]	Low ambient temp. for LWT main zone cooling WD curve.	R/W	10-25°C, step: 1°C 20°C		
2.6	[1-07]	High ambient temp. for LWT main zone cooling WD curve.	R/W	25-43°C, step: 1°C 35°C		
2.6	[1-08]	Leaving water value for low ambient temp. for LWT main zone cooling WD curve.	R/W	[9-03]-[9-02]°C, step: 1°C 22°C		
2.6	[1-09]	Leaving water value for high ambient temp. for LWT main zone cooling WD curve.	R/W	[9-03]-[9-02]°C, step: 1°C [2-0C]=0 18°C [2-0C]=1 7°C [2-0C]=2 18°C		
Main zone						
2.7	[2-0C]	Emitter type	R/W	0: Underfloor heating 1: Fancoil unit 2: Radiator		
└ Setpoint range						
2.8.1	[9-01]	Heating minimum	R/W	15-37°C, step: 1°C 25°C		
2.8.2	[9-00]	Heating maximum	R/W	[2-0C]=2: 37-70, step: 1°C 70°C [2-0C]≠2: 37-55, step: 1°C 55°C		
2.8.3	[9-03]	Cooling minimum	R/W	5-18°C, step: 1°C 7°C		
2.8.4	[9-02]	Cooling maximum	R/W	18-22°C, step: 1°C 22°C		
Main zone						
2.9	[C-07]	Control	R/W	0: LWT control 1: Ext RT control 2: RT control		
2.A	[C-05]	Thermostat type	R/W	0: - 1: 1 contact 2: 2 contacts		
└ Delta T						
2.B.1	[1-0B]	Delta T heating	R/W	3-10°C, step: 1°C 5°C		
2.B.2	[1-0D]	Delta T cooling	R/W	3-10°C, step: 1°C 5°C		
└ Modulation						
2.C.1	[8-05]	Modulation	R/W	0: No 1: Yes		
2.C.2	[8-06]	Max modulation	R/W	0-10°C, step: 1°C 5°C		
└ Shut off valve						
2.D.1	[F-0B]	During thermo	R/W	0: No 1: Yes		
2.D.2	[F-0C]	During cooling	R/W	0: No 1: Yes		
Main zone						
2.E		WD curve type	R/W	0: 2-points 1: Slope-Offset		1
Additional zone						

Field settings table				Installer setting at variance with default value		
Breadcrumb	Field code	Setting name	Range, step	Default value	Date	Official Value
3.4		Setpoint mode		0: Fixed 1: WD heating, fixed cooling 2: Weather dependent		
└ Heating WD curve						
3.5	[0-00]	Leaving water value for high ambient temp. for LWT add zone heating WD curve.	R/W	[9-05]~min(45,[9-06])°C, step: 1°C <u>[2-0C]=0</u> 25°C <u>[2-0C]=1</u> 35°C <u>[2-0C]=2</u> 35°C		
3.5	[0-01]	Leaving water value for low ambient temp. for LWT add zone heating WD curve.	R/W	[9-05]~[9-06]°C, step: 1°C <u>[2-0C]=0</u> 35°C <u>[2-0C]=1</u> 45°C <u>[2-0C]=2</u> 65°C		
3.5	[0-02]	High ambient temp. for LWT add zone heating WD curve.	R/W	10~25°C, step: 1°C 15°C		
3.5	[0-03]	Low ambient temp. for LWT add zone heating WD curve.	R/W	-40~5°C, step: 1°C -15°C		
└ Cooling WD curve						
3.6	[0-04]	Leaving water value for high ambient temp. for LWT add zone cooling WD curve.	R/W	[9-07]~[9-08]°C, step: 1°C <u>[2-0C]=0</u> 18°C <u>[2-0C]=1</u> 7°C <u>[2-0C]=2</u> 18°C		
3.6	[0-05]	Leaving water value for low ambient temp. for LWT add zone cooling WD curve.	R/W	[9-07]~[9-08]°C, step: 1°C 22°C		
3.6	[0-06]	High ambient temp. for LWT add zone cooling WD curve.	R/W	25~43°C, step: 1°C 35°C		
3.6	[0-07]	Low ambient temp. for LWT add zone cooling WD curve.	R/W	10~25°C, step: 1°C 20°C		
Additional zone						
3.7	[2-0D]	Emitter type	R/W	0: Underfloor heating 1: Fancoil unit 2: Radiator		
└ Setpoint range						
3.8.1	[9-05]	Heating minimum	R/W	15~37°C, step: 1°C 25°C		
3.8.2	[9-06]	Heating maximum	R/W	<u>[2-0D]=2:</u> 37~70, step: 1°C 70°C <u>[2-0D]=2:</u> 37~55, step: 1°C 55°C		
3.8.3	[9-07]	Cooling minimum	R/W	5~18°C, step: 1°C 7°C		
3.8.4	[9-08]	Cooling maximum	R/W	18~22°C, step: 1°C 22°C		
Additional zone						
3.A	[C-06]	Thermostat type	R/W	0: - 1: 1 contact 2: 2 contacts		
└ Delta T						
3.B.1	[1-0C]	Delta T heating	R/W	3~10°C, step: 1°C 10°C		
3.B.2	[1-0E]	Delta T cooling	R/W	3~10°C, step: 1°C 5°C		
Additional zone						
3.C		WD curve type	R/O	0: 2-points 1: Slope-Offset		
Space heating / cooling						
└ Operation range						
4.3.1	[4-02]	Space heating OFF temp	R/W	14~35°C, step: 1°C 35°C		
4.3.2	[F-01]	Space cooling OFF temp	R/W	10~35°C, step: 1°C 20°C		
Space heating / cooling						
4.4	[7-02]	Number of zones	R/W	0: 1 LWT zone 1: 2 LWT zones		
4.5	[F-0D]	Pump operation mode	R/W	0: Continuous 1: Sample 2: Request		
4.6	[E-02]	Unit type	R/W (*5) R/O (*6)	0: Reversible (*5) 1: Heating only (*6)		
4.7	[9-0D]	Pump limitation	R/W	0~8, step:1 0: No limitation 1~4: 50~80% 5~8: 50~80% during sampling 6		
Space heating / cooling						
4.9	[F-00]	Pump outside range	R/W	0: Restricted 1: Allowed		
4.A	[D-03]	Increase around 0°C	R/W	0: No 1: increase 2°C, span 4°C 2: increase 4°C, span 4°C 3: increase 2°C, span 8°C 4: increase 4°C, span 8°C		
4.B	[9-04]	Overshoot	R/W	1~4°C, step: 1°C 1°C		
4.C	[2-06]	Antifrost	R/W	0: Disabled 1: Enabled		
Tank						
5.2	[6-0A]	Comfort setpoint	R/W	30~[6-0E]°C, step: 1°C 60°C		
5.3	[6-0B]	Eco setpoint	R/W	30~min(50, [6-0E])°C, step: 1°C 45°C		

(*1) *6V_(*) *9W_
 (*3) ETB*_(*) ETV*_
 (*5) *X*_(*) *H*

(#) Only applicable in Swedish language.

4P586458-1A - 2020.10

Field settings table					Installer setting at variance with default value	
Breadcrumb	Field code	Setting name		Range, step Default value	Date	Official Value
	[6-0C]	Reheat setpoint	R/W	30~min(50, [6-0E])°C, step: 1°C 45°C		
	[6-0D]	Heat up mode	R/W	0: Reheat only 1: Reheat + sched. 2: Scheduled only		
└─ Disinfection						
	[2-01]	Activation	R/W	0: No 1: Yes		
	[2-00]	Operation day	R/W	0: Each day 1: Monday 2: Tuesday 3: Wednesday 4: Thursday 5: Friday 6: Saturday 7: Sunday		
	[2-02]	Start time	R/W	0~23 hour, step: 1 hour 1		
	[2-03]	Tank setpoint	R/W	[E-07]≠1 : 55~75°C, step: 5°C 70°C [E-07]=1 : 60°C 60°C		
	[2-04]	Duration	R/W	[E-07]≠1: 5~60 min, step: 5 min 10 min [E-07]=1: 40~60 min, step: 5 min 40 min		
Tank						
	[6-0E]	Maximum	R/W	(*3) [E-07]=0: 40~75°C, step: 1°C 60°C (*3) [E-07]=5: 40~80°C, step: 1°C 80°C (*4) : 40~65°C, step: 1°C 65°C		
	[6-00]	Hysteresis	R/W	2~40°C, step: 1°C 8°C		
	[6-08]	Reheat hysteresis	R/W	2~20°C, step: 1°C 10°C		
		Setpoint mode	R/W	0: Fixed 1: Weather dependent		
└─ WD curve						
	[0-0B]	Leaving water value for high ambient temp. for DHW WD curve.	R/W	35~[6-0E]°C, step: 1°C 55°C		
	[0-0C]	Leaving water value for low ambient temp. for DHW WD curve.	R/W	45~[6-0E]°C, step: 1°C 60°C		
	[0-0D]	High ambient temp. for DHW WD curve.	R/W	10~25°C, step: 1°C 15°C		
	[0-0E]	Low ambient temp. for DHW WD curve.	R/W	-40~5°C, step: 1°C -10°C		
Tank						
	[6-01]	Margin	R/W	0~10°C, step: 1°C 2°C		
		WD curve type	R/O	0: 2-points 1: Slope-Offset		
User settings						
└─ Quiet						
		Activation	R/W	0: OFF 1: Manual 2: Automatic		
		Level	R/W	0: Quiet 1: More Quiet 2: Most Quiet		
└─ Electricity price						
		High	R/W	0,00~990/kWh 1/kWh		
		Medium	R/W	0,00~990/kWh 1/kWh		
		Low	R/W	0,00~990/kWh 1/kWh		
User settings						
		Gas price	R/W	0,00~990/kWh 0,00~290/MBtu 1,0/kWh		
Installer settings						
└─ Configuration wizard						
└─ System						
	[E-03]	BUH type	R/O	3: 6V (*1) 4: 9W (*2)		
	[E-05] [E-06] [E-07]	Domestic hot water	R/W	No DHW (*3) EKHW (*3) Integrated (*4) EKHWP (*3)		
	[4-06]	Emergency	R/W	0: Manual 1: Automatic 2: Auto red SH/ DHW ON 3: Auto red SH/ DHW OFF 4: Auto normal SH/ DHW OFF		
	[7-02]	Number of zones	R/W	0: Single zone 1: Dual zone		
	[E-0D]	Glycol Filled system	R/W	0: No 1: Yes		
	[6-02]	BSH capacity (*3)	R/W	0~10kW, step: 0,2kW 3kW (*3) 0kW (*4)		
└─ Backup heater						
	[5-0D]	Voltage	R/W (*1) R/O (*2)	0: 230V, 1~ (*1) 1: 230V, 3~ (*1) 2: 400V, 3~ (*2)		

Field settings table					Installer setting at variance with default value		
Breadcrumb	Field code	Setting name		Range, step	Default value	Date	Official Value
9.1.4.2	[4-0A]	Configuration	R/W	0: 1 1: 1/1+2 (*1) (*2) 2: 1/2 3: 1/2 + 1/1+2 in emergency			
9.1.4.3	[6-03]	Capacity step 1	R/W	0-10kW, step: 0,2kW 2kW (*1) 3kW (*2)			
9.1.4.4	[6-04]	Additional capacity step 2	R/W	0-10kW, step: 0,2kW 4kW (*1) 6kW (*2)			
Main zone							
9.1.5.1	[2-0C]	Emitter type	R/W	0: Underfloor heating 1: Fancoil unit 2: Radiator			
9.1.5.2	[C-07]	Control	R/W	0: LWT control 1: Ext RT control 2: RT control			
9.1.5.3		Setpoint mode	R/W	0: Fixed 1: WD heating, fixed cooling 2: Weather dependent			
9.1.5.4		Schedule	R/W	0: No 1: Yes			
9.1.5.5		WD curve type	R/W	0: 2-points 1: Slope-Offset			
9.1.6	[1-00]	Low ambient temp. for LWT main zone heating WD curve.	R/W	-40-5°C, step: 1°C -15°C			
9.1.6	[1-01]	High ambient temp. for LWT main zone heating WD curve.	R/W	10-25°C, step: 1°C 15°C			
9.1.6	[1-02]	Leaving water value for low ambient temp. for LWT main zone heating WD curve.	R/W	[9-01]-[9-00], step: 1°C [2-0C]=0 35°C [2-0C]=1 45°C [2-0C]=2 65°C			
9.1.6	[1-03]	Leaving water value for high ambient temp. for LWT main zone heating WD curve.	R/W	[9-01]-min(45, [9-00])°C, step: 1°C [2-0C]=0 25°C [2-0C]=1 35°C [2-0C]=2 35°C			
9.1.7	[1-06]	Low ambient temp. for LWT main zone cooling WD curve.	R/W	10-25°C, step: 1°C 20°C			
9.1.7	[1-07]	High ambient temp. for LWT main zone cooling WD curve.	R/W	25-43°C, step: 1°C 35°C			
9.1.7	[1-08]	Leaving water value for low ambient temp. for LWT main zone cooling WD curve.	R/W	[9-03]-[9-02]°C, step: 1°C 22°C			
9.1.7	[1-09]	Leaving water value for high ambient temp. for LWT main zone cooling WD curve.	R/W	[9-03]-[9-02]°C, step: 1°C [2-0C]=0 18°C [2-0C]=1 7°C [2-0C]=2 18°C			
Additional zone							
9.1.8.1	[2-0D]	Emitter type	R/W	0: Underfloor heating 1: Fancoil unit 2: Radiator			
9.1.8.3		Setpoint mode	R/W	0: Fixed 1: WD heating, fixed cooling 2: Weather dependent			
9.1.8.4		Schedule	R/W	0: No 1: Yes			
9.1.9	[0-00]	Leaving water value for high ambient temp. for LWT add zone heating WD curve.	R/W	[9-05]-min(45, [9-06])°C, step: 1°C [2-0C]=0 25°C [2-0C]=1 35°C [2-0C]=2 35°C			
9.1.9	[0-01]	Leaving water value for low ambient temp. for LWT add zone heating WD curve.	R/W	[9-05]-[9-06]°C, step: 1°C [2-0C]=0 35°C [2-0C]=1 45°C [2-0C]=2 65°C			
9.1.9	[0-02]	High ambient temp. for LWT add zone heating WD curve.	R/W	10-25°C, step: 1°C 15°C			
9.1.9	[0-03]	Low ambient temp. for LWT add zone heating WD curve.	R/W	-40-5°C, step: 1°C -15°C			
9.1.A	[0-04]	Leaving water value for high ambient temp. for LWT add zone cooling WD curve.	R/W	[9-07]-[9-08]°C, step: 1°C [2-0C]=0 18°C [2-0C]=1 7°C [2-0C]=2 18°C			
9.1.A	[0-05]	Leaving water value for low ambient temp. for LWT add zone cooling WD curve.	R/W	[9-07]-[9-08]°C, step: 1°C 22°C			
9.1.A	[0-06]	High ambient temp. for LWT add zone cooling WD curve.	R/W	25-43°C, step: 1°C 35°C			
9.1.A	[0-07]	Low ambient temp. for LWT add zone cooling WD curve.	R/W	10-25°C, step: 1°C 20°C			
Tank							
9.1.B.1	[6-0D]	Heat up mode	R/W	0: Reheat only 1: Reheat + sched. 2: Scheduled only			
9.1.B.2	[6-0A]	Comfort setpoint	R/W	30-[6-0E]°C, step: 1°C 60°C			

(*1) *6V_(*2) *9W_
(*3) ETB*(*4) ETV*_
(*5) *X*_(*6) *H*

(#) Only applicable in Swedish language.

4P586458-1A - 2020.10

Field settings table					Installer setting at variance with default value	
Breadcrumb	Field code	Setting name		Range, step Default value	Date	Official Value
9.1.B.3	[6-0B]	Eco setpoint	R/W	30~min(50, [6-0E])°C, step: 1°C 45°C		
9.1.B.4	[6-0C]	Reheat setpoint	R/W	30~min(50, [6-0E])°C, step: 1°C 45°C		
9.1.B.5	[6-08]	Reheat hysteresis	R/W	2~20°C, step: 1°C 10°C		
└ Domestic hot water						
9.2.1	[E-05] [E-06] [E-07]	Domestic hot water	R/W	No DHW (*3) EKHW (*3) Integrated (*4) EKHWP (*3)		
9.2.2	[D-02]	DHW pump	R/W	0: No DHW pump 1: Instant hot water 2: Disinfection 3: Circulation 4: Circulation and disinfection		
9.2.4	[D-07]	Solar	R/W	0: No 1: Yes		
└ Back up heater						
9.3.1	[E-03]	BUH type	R/O	3: 6V (*1) 4: 9W (*2)		
9.3.2	[5-0D]	Voltage	R/W (*1) R/O (*2)	0: 230V, 1~ (*1) 1: 230V, 3~ (*1) 2: 400V, 3~ (*2)		
9.3.3	[4-0A]	Configuration	R/W	1: 1/1+2 (*1) (*2) 2: 1/2 3: 1/2 + 1/1+2 in emergency		
9.3.4	[6-03]	Capacity step 1	R/W	0~10kW, step: 0,2kW 2kW (*1) 3kW (*2)		
9.3.5	[6-04]	Additional capacity step 2	R/W	0~10kW, step: 0,2kW 4kW (*1) 6kW (*2)		
9.3.6	[5-00]	Equilibrium	R/W	0: Allowed 1: Not allowed		
9.3.7	[5-01]	Equilibrium temperature	R/W	-15~35°C, step: 1°C 0°C		
9.3.8	[4-00]	Operation	R/W	0: Disabled 1: Enabled 2: Only DHW		
└ Booster heater						
9.4.1	[6-02]	Capacity	R/W	0~10kW, step: 0,2kW 3kW (*3) 0kW (*4)		
9.4.3	[8-03]	BSH eco timer	R/W	20~95 min, step: 5 min 50 min		
9.4.4	[4-03]	Operation	R/W	0: Restricted 1: Allowed 2: Overlap 3: Compressor off 4: Legionella only		
└ Emergency						
9.5.1	[4-06]	Emergency	R/W	0: Manual 1: Automatic 2: Auto red SH/ DHW ON 3: Auto red SH/ DHW OFF 4: Auto normal SH/ DHW OFF		
9.5.2	[7-06]	HP Forced OFF	R/W	0: Disabled 1: Enabled		
└ Balancing						
9.6.1	[5-02]	Space heating priority	R/W	0: Disabled 1: Enabled		
9.6.2	[5-03]	Priority temperature	R/W	-15~35°C, step: 1°C 0°C		
9.6.3	[5-04]	Offset BSH setpoint	R/W	0~20°C, step: 1°C 10°C		
9.6.4	[8-02]	Anti-recycle timer	R/W	0~10 hour, step: 0.5 hour 0,5 hour [E-07]=1 3 hour [E-07]≠1		
9.6.5	[8-00]	Minimum running timer	R/W	0~20 min, step 1 min 1 min		
9.6.6	[8-01]	Maximum running timer	R/W	5~95 min, step: 5 min 30 min		
9.6.7	[8-04]	Additional timer	R/W	0~95 min, step: 5 min 95 min		
Installer settings						
9.7	[4-04]	Water pipe freeze prevention	R/O	0: Intermittent		
└ Benefit kWh power supply						
9.8.1	[D-01]	Benefit kWh power supply	R/W	0: No 1: Active open 2: Active closed 3: Safety thermostat		
9.8.2	[D-00]	Allow heater	R/W	0: None 1: BSH only 2: BUH only 3: All heaters		
9.8.3	[D-05]	Allow pump	R/W	0: Forced off 1: As normal		
└ Power consumption control						
9.9.1	[4-08]	Power consumption control	R/W	0: No limitation 1: Continuous 2: Digital inputs		
9.9.2	[4-09]	Type	R/W	0: Current 1: Power		
9.9.3	[5-05]	Limit	R/W	0~50 A, step: 1 A 50 A		
9.9.4	[5-05]	Limit 1	R/W	0~50 A, step: 1 A 50 A		
9.9.5	[5-06]	Limit 2	R/W	0~50 A, step: 1 A 50 A		
9.9.6	[5-07]	Limit 3	R/W	0~50 A, step: 1 A 50 A		

Field settings table					Installer setting at variance with default value		
Breadcrumb	Field code	Setting name		Range, step	Default value	Date	Official Value
9.9.7	[5-08]	Limit 4	R/W	0-50 A, step: 1 A	50 A		
9.9.8	[5-09]	Limit	R/W	0-20 kW, step: 0,5 kW	20 kW		
9.9.9	[5-09]	Limit 1	R/W	0-20 kW, step: 0,5 kW	20 kW		
9.9.A	[5-0A]	Limit 2	R/W	0-20 kW, step: 0,5 kW	20 kW		
9.9.B	[5-0B]	Limit 3	R/W	0-20 kW, step: 0,5 kW	20 kW		
9.9.C	[5-0C]	Limit 4	R/W	0-20 kW, step: 0,5 kW	20 kW		
9.9.D	[4-01]	Priority heater			0: None 1: BSH 2: BUH		
9.9.F	[7-07]	BBR16 activation (#)	R/W		0: Disabled 1: Enabled		
└ Energy metering							
9.A.1	[D-08]	Electricity meter 1	R/W		0: No 1: 0,1 pulse/kWh 2: 1 pulse/kWh 3: 10 pulse/kWh 4: 100 pulse/kWh 5: 1000 pulse/kWh		
9.A.2	[D-09]	Electricity meter 2	R/W		0: No 1: 0,1 pulse/kWh 2: 1 pulse/kWh 3: 10 pulse/kWh 4: 100 pulse/kWh 5: 1000 pulse/kWh		
└ Sensors							
9.B.1	[C-08]	External sensor	R/W		0: No 1: Outdoor sensor 2: Room sensor		
9.B.2	[2-0B]	Ext. amb. sensor offset	R/W	-5-5°C, step: 0,5°C	0°C		
9.B.3	[1-0A]	Averaging time	R/W		0: No averaging 1: 12 hours 2: 24 hours 3: 48 hours 4: 72 hours		
└ Bivalent							
9.C.1	[C-02]	Bivalent	R/W		0: No 1: Bivalent		
9.C.2	[7-05]	Boiler efficiency	R/W		0: Very high 1: High 2: Medium 3: Low 4: Very low		
9.C.3	[C-03]	Temperature	R/W	-25-25°C, step: 1°C	0°C		
9.C.4	[C-04]	Hysteresis	R/W	2-10°C, step 1°C	3°C		
Installer settings							
9.D	[C-09]	Alarm output	R/W		0: Normally open 1: Normally closed		
9.E	[3-00]	Auto restart	R/W		0: No 1: Yes		
9.F	[E-08]	Power saving function	R/W		0: disabled 1: Enabled		
9.G		Disable protections	R/W		0: No 1: Yes		
└ Overview field settings							
9.I	[0-00]	Leaving water value for high ambient temp. for LWT add zone heating WD curve.	R/W		[9-05]-min(45,[9-06])°C, step: 1°C [2-0C]=0 25°C [2-0C]=1 35°C [2-0C]=2 55°C		
9.I	[0-01]	Leaving water value for low ambient temp. for LWT add zone heating WD curve.	R/W		[9-05]-[9-06]°C, step: 1°C [2-0C]=0 35°C [2-0C]=1 45°C [2-0C]=2 65°C		
9.I	[0-02]	High ambient temp. for LWT add zone heating WD curve.	R/W	10-25°C, step: 1°C	15°C		
9.I	[0-03]	Low ambient temp. for LWT add zone heating WD curve.	R/W	-40-5°C, step: 1°C	-15°C		
9.I	[0-04]	Leaving water value for high ambient temp. for LWT add zone cooling WD curve.	R/W		[9-07]-[9-08]°C, step: 1°C [2-0C]=0 18°C [2-0C]=1 7°C [2-0C]=2 18°C		
9.I	[0-05]	Leaving water value for low ambient temp. for LWT add zone cooling WD curve.	R/W		[9-07]-[9-08]°C, step: 1°C 22°C		
9.I	[0-06]	High ambient temp. for LWT add zone cooling WD curve.	R/W	25-43°C, step: 1°C	35°C		
9.I	[0-07]	Low ambient temp. for LWT add zone cooling WD curve.	R/W	10-25°C, step: 1°C	20°C		
9.I	[0-0B]	Leaving water value for high ambient temp. for DHW WD curve.	R/W	35-[6-0E]°C, step: 1°C	55°C		
9.I	[0-0C]	Leaving water value for low ambient temp. for DHW WD curve.	R/W	45-[6-0E]°C, step: 1°C	60°C		
9.I	[0-0D]	High ambient temp. for DHW WD curve.	R/W	10-25°C, step: 1°C	15°C		
9.I	[0-0E]	Low ambient temp. for DHW WD curve.	R/W	-40-5°C, step: 1°C	-10°C		

(*1) *6V_(*) *9W_
 (*3) ETB*_*4) ETV*_
 (*5) *X*_*6) *H*

(#) Only applicable in Swedish language.

4P586458-1A - 2020.10

Field settings table				Installer setting at variance with default value		
Breadcrumb	Field code	Setting name	Range, step	Default value	Date	Official Value
9.1	[1-00]	Low ambient temp. for LWT main zone heating WD curve.	R/W	40-5°C, step: 1°C -15°C		
9.1	[1-01]	High ambient temp. for LWT main zone heating WD curve.	R/W	10-25°C, step: 1°C 15°C		
9.1	[1-02]	Leaving water value for low ambient temp. for LWT main zone heating WD curve.	R/W	[9-01]-[9-00], step: 1°C [2-0C]=0 35°C [2-0C]=1 45°C [2-0C]=2 55°C		
9.1	[1-03]	Leaving water value for high ambient temp. for LWT main zone heating WD curve.	R/W	[9-01]-min(45, [9-00])°C, step: 1°C [2-0C]=0 25°C [2-0C]=1 35°C [2-0C]=2 35°C		
9.1	[1-04]	Weather dependent cooling of the main leaving water temperature zone.	R/W	0: Disabled 1: Enabled		
9.1	[1-05]	Weather dependent cooling of the additional leaving water temperature zone	R/W	0: Disabled 1: Enabled		
9.1	[1-06]	Low ambient temp. for LWT main zone cooling WD curve.	R/W	10-25°C, step: 1°C 20°C		
9.1	[1-07]	High ambient temp. for LWT main zone cooling WD curve.	R/W	25-43°C, step: 1°C 35°C		
9.1	[1-08]	Leaving water value for low ambient temp. for LWT main zone cooling WD curve.	R/W	[9-03]-[9-02]°C, step: 1°C 22°C		
9.1	[1-09]	Leaving water value for high ambient temp. for LWT main zone cooling WD curve.	R/W	[9-03]-[9-02]°C, step: 1°C [2-0C]=0 18°C [2-0C]=1 7°C [2-0C]=2 18°C		
9.1	[1-0A]	What is the averaging time for the outdoor temp?	R/W	0: No averaging 1: 12 hours 2: 24 hours 3: 48 hours 4: 72 hours		
9.1	[1-0B]	What is the desired delta T in heating for the main zone?	R/W	3-10°C, step: 1°C 5°C		
9.1	[1-0C]	What is the desired delta T in heating for the additional zone?	R/W	3-10°C, step: 1°C 10°C		
9.1	[1-0D]	What is the desired delta T in cooling for the main zone?	R/W	3-10°C, step: 1°C 5°C		
9.1	[1-0E]	What is the desired delta T in cooling for the additional zone?	R/W	3-10°C, step: 1°C 5°C		
9.1	[2-00]	When should the disinfection function be executed?	R/W	0: Each day 1: Monday 2: Tuesday 3: Wednesday 4: Thursday 5: Friday 6: Saturday 7: Sunday		
9.1	[2-01]	Should the disinfection function be executed?	R/W	0: No 1: Yes		
9.1	[2-02]	When should the disinfection function start?	R/W	0-23 hour, step: 1 hour 1		
9.1	[2-03]	What is the disinfection target temperature?	R/W	[E-07]#1 : 55-75°C, step: 5°C 70°C [E-07]=1 : 60°C 60°C		
9.1	[2-04]	How long must the tank temperature be maintained?	R/W	[E-07]#1: 5-60 min, step: 5 min 10 min [E-07]=1: 40-60 min, step: 5 min 40 min		
9.1	[2-05]	Room antifrost temperature	R/W	4-16°C, step: 1°C 8°C		
9.1	[2-06]	Room frost protection	R/W	0: Disabled 1: Enabled		
9.1	[2-09]	Adjust the offset on the measured room temperature	R/W	-5-5°C, step: 0,5°C 0°C		
9.1	[2-0A]	Adjust the offset on the measured room temperature	R/W	-5-5°C, step: 0,5°C 0°C		
9.1	[2-0B]	What is the required offset on the measured outdoor temp.?	R/W	-5-5°C, step: 0,5°C 0°C		
9.1	[2-0C]	What emitter type is connected to the main LWT zone?	R/W	0: Underfloor heating 1: Fancoil unit 2: Radiator		
9.1	[2-0D]	What emitter type is connected to the additional LWT zone?	R/W	0: Underfloor heating 1: Fancoil unit 2: Radiator		
9.1	[2-0E]	What is the maximum allowed current over the heatpump ?	R/W	0-50 A, step: 1 A 50 A		
9.1	[3-00]	Is auto restart of the unit allowed?	R/W	0: No 1: Yes		
9.1	[3-01]	--		0		
9.1	[3-02]	--		1		
9.1	[3-03]	--		4		
9.1	[3-04]	--		2		
9.1	[3-05]	--		1		
9.1	[3-06]	What is the maximum desired room temperature in heating?	R/W	18-30°C, step: 0,5°C 30°C		
9.1	[3-07]	What is the minimum desired room temperature in heating?	R/W	12-18°C, step: 0,5°C 12°C		
9.1	[3-08]	What is the maximum desired room temperature in cooling?	R/W	25-35°C, step: 0,5°C 35°C		

Field settings table				Installer setting at variance with default value		
Breadcrumb	Field code	Setting name	Range, step	Default value	Date	Official Value
9.1	[3-09]	What is the minimum desired room temperature in cooling?	R/W	15~25°C, step: 0,5°C 15°C		
9.1	[4-00]	What is the BUH operation mode?	R/W	0: Disabled 1: Enabled 2: Only DHW		
9.1	[4-01]	Which electric heater has priority?	R/W	0: None 1: BSH 2: BUH		
9.1	[4-02]	Below which outdoor temperature is heating allowed?	R/W	14~35°C, step: 1°C 35°C		
9.1	[4-03]	Operation permission of the booster heater.	R/W	0: Restricted 1: Allowed 2: Overlap 3: Compressor off 4: Legionella only		
9.1	[4-04]	Water pipe freeze prevention	R/O	0: Intermittent		
9.1	[4-05]	--		0		
9.1	[4-06]	Emergency	R/W	0: Manual 1: Automatic 2: Auto red SH/ DHW ON 3: Auto red SH/ DHW OFF 4: Auto normal SH/ DHW OFF		
9.1	[4-07]	--		6		
9.1	[4-08]	Which power limitation mode is required on the system?	R/W	0: No limitation 1: Continuous 2: Digital inputs		
9.1	[4-09]	Which power limitation type is required?	R/W	0: Current 1: Power		
9.1	[4-0A]	Backup heater configuration	R/W	1: 1/1+2 (*1) (*2) 2: 1/2 3: 1/2 + 1/1+2 in emergency		
9.1	[4-0B]	Automatic cooling/heating changeover hysteresis.	R/W	1~10°C, step: 0,5°C 1°C		
9.1	[4-0D]	Automatic cooling/heating changeover offset.	R/W	1~10°C, step: 0,5°C 3°C		
9.1	[4-0E]	--		6		
9.1	[5-00]	Is backup heater operation allowed above equilibrium temperature during space heating operation?	R/W	0: Allowed 1: Not allowed		
9.1	[5-01]	What is the equilibrium temperature for the building?	R/W	-15~35°C, step: 1°C 0°C		
9.1	[5-02]	Space heating priority.	R/W	0: Disabled 1: Enabled		
9.1	[5-03]	Space heating priority temperature.	R/W	-15~35°C, step: 1°C 0°C		
9.1	[5-04]	Set point correction for domestic hot water temperature.	R/W	0~20°C, step: 1°C 10°C		
9.1	[5-05]	What is the requested limit for DI1?	R/W	0~50 A, step: 1 A 50 A		
9.1	[5-06]	What is the requested limit for DI2?	R/W	0~50 A, step: 1 A 50 A		
9.1	[5-07]	What is the requested limit for DI3?	R/W	0~50 A, step: 1 A 50 A		
9.1	[5-08]	What is the requested limit for DI4?	R/W	0~50 A, step: 1 A 50 A		
9.1	[5-09]	What is the requested limit for DI1?	R/W	0~20 kW, step: 0,5 kW 20 kW		
9.1	[5-0A]	What is the requested limit for DI2?	R/W	0~20 kW, step: 0,5 kW 20 kW		
9.1	[5-0B]	What is the requested limit for DI3?	R/W	0~20 kW, step: 0,5 kW 20 kW		
9.1	[5-0C]	What is the requested limit for DI4?	R/W	0~20 kW, step: 0,5 kW 20 kW		
9.1	[5-0D]	Backup heater voltage	R/W (*1) R/O (*2)	0: 230V, 1~ (*1) 1: 230V, 3~ (*1) 2: 400V, 3~ (*2)		
9.1	[5-0E]	--		1		
9.1	[6-00]	The temperature difference determining the heat pump ON temperature.	R/W	2~40°C, step: 1°C 8°C		
9.1	[6-01]	The temperature difference determining the heat pump OFF temperature.	R/W	0~10°C, step: 1°C 2°C		
9.1	[6-02]	What is the capacity of the booster heater?	R/W	0~10kW, step: 0,2kW 3kW (*3) 0kW (*4)		
9.1	[6-03]	What is the capacity of the backup heater step 1?	R/W	0~10kW, step: 0,2kW 2kW (*1) 3kW (*2)		
9.1	[6-04]	What is the capacity of the backup heater step 2?	R/W	0~10kW, step: 0,2kW 4kW (*1) 6kW (*2)		
9.1	[6-05]	--		0		
9.1	[6-06]	--		0		
9.1	[6-07]	--		0		
9.1	[6-08]	What is the hysteresis to be used in reheat mode?	R/W	2~20°C, step: 1°C 10°C		
9.1	[6-09]	--		0		
9.1	[6-0A]	What is the desired comfort storage temperature?	R/W	30~[6-0E]°C, step: 1°C 60°C		
9.1	[6-0B]	What is the desired eco storage temperature?	R/W	30~min(50, [6-0E])°C, step: 1°C 45°C		
9.1	[6-0C]	What is the desired reheat temperature?	R/W	30~min(50, [6-0E])°C, step: 1°C 45°C		
9.1	[6-0D]	What is the desired DHW production type?	R/W	0: Reheat only 1: Reheat + sched. 2: Scheduled only		
9.1	[6-0E]	What is the maximum temperature setpoint?	R/W	(*3) [E-07]=0: 40~75°C, step: 1°C 60°C (*3) [E-07]=5: 40~80°C, step: 1°C 80°C (*4) : 40~65°C, step: 1°C 65°C		

(*1) *6V_(*2) *9W_
(*3) ETB*(*4) ETV*_
(*5) *X*_(*6) *H*

(#) Only applicable in Swedish language.

4P586458-1A - 2020.10

Field settings table					Installer setting at variance with default value		
Breadcrumb	Field code	Setting name		Range, step	Default value	Date	Official Value
9.1	[7-00]	Domestic hot water booster heater overshoot temperature.	R/W	0~4°C, step: 1°C	0°C		
9.1	[7-01]	Domestic hot water booster heater hysteresis.	R/W	2~40°C, step: 1°C	2°C		
9.1	[7-02]	How many leaving water temperature zones are there?	R/W	0: 1 LWT zone 1: 2 LWT zones	0		
9.1	[7-03]	--			2,5		
9.1	[7-04]	--			0		
9.1	[7-05]	Boiler efficiency	R/W	0: Very high 1: High 2: Medium 3: Low 4: Very low	0		
9.1	[7-06]	HP Forced OFF	R/W	0: Disabled 1: Enabled	0		
9.1	[7-07]	BBR16 activation (#)	R/W	0: Disabled 1: Enabled	0		
9.1	[8-00]	Minimum running time for domestic hot water operation.	R/W	0~20 min, step: 1 min	1 min		
9.1	[8-01]	Maximum running time for domestic hot water operation.	R/W	5~95 min, step: 5 min	30 min		
9.1	[8-02]	Anti-recycling time.	R/W	0~10 hour, step: 0,5 hour	0,5 hour [E-07]=1 3 hour [E-07]#1		
9.1	[8-03]	Booster heater delay timer.	R/W	20~95 min, step: 5 min	50 min		
9.1	[8-04]	Additional running time for the maximum running time.	R/W	0~95 min, step: 5 min	95 min		
9.1	[8-05]	Allow modulation of the LWT to control the room temp?	R/W	0: No 1: Yes	0		
9.1	[8-06]	Leaving water temperature maximum modulation.	R/W	0~10°C, step: 1°C	5°C		
9.1	[8-07]	What is the desired comfort main LWT in cooling?	R/W	[9-03]~[9-02], step: 1°C	18°C		
9.1	[8-08]	What is the desired eco main LWT in cooling?	R/W	[9-03]~[9-02], step: 1°C	20°C		
9.1	[8-09]	What is the desired comfort main LWT in heating?	R/W	[9-01]~[9-00], step: 1°C	35°C		
9.1	[8-0A]	What is the desired eco main LWT in heating?	R/W	[9-01]~[9-00], step: 1°C	33°C		
9.1	[8-0B]	--			13		
9.1	[8-0C]	--			10		
9.1	[8-0D]	--			16		
9.1	[9-00]	What is the maximum desired LWT for main zone in heating?	R/W	[2-0C]#2: 37~70, step: 1°C 70°C [2-0C]#2: 37~55, step: 1°C 55°C			
9.1	[9-01]	What is the minimum desired LWT for main zone in heating?	R/W	15~37°C, step: 1°C	25°C		
9.1	[9-02]	What is the maximum desired LWT for main zone in cooling?	R/W	18~22°C, step: 1°C	22°C		
9.1	[9-03]	What is the minimum desired LWT for main zone in cooling?	R/W	5~18°C, step: 1°C	7°C		
9.1	[9-04]	Leaving water temperature overshoot temperature.	R/W	1~4°C, step: 1°C	1°C		
9.1	[9-05]	What is the minimum desired LWT for add. zone in heating?	R/W	15~37°C, step: 1°C	25°C		
9.1	[9-06]	What is the maximum desired LWT for add. zone in heating?	R/W	[2-0D]#2: 37~70, step: 1°C 70°C [2-0D]#2: 37~55, step: 1°C 55°C			
9.1	[9-07]	What is the minimum desired LWT for add. zone in cooling?	R/W	5~18°C, step: 1°C	7°C		
9.1	[9-08]	What is the maximum desired LWT for add. zone in cooling?	R/W	18~22°C, step: 1°C	22°C		
9.1	[9-0C]	Room temperature hysteresis.	R/W	1~6°C, step: 0,5°C	1°C		
9.1	[9-0D]	Pump speed limitation	R/W	0~8, step:1 0 : No limitation 1~4 : 50~80% 5~8 : 50~80% during sampling	6		
9.1	[9-0E]	--			6		
9.1	[C-00]	Domestic heating water priority.	R/W	0: Solar priority 1: Heat pump priority	1		
9.1	[C-01]	--			0		
9.1	[C-02]	Is an external backup heat source connected?	R/W	0: No 1: Bivalent	0		
9.1	[C-03]	Bivalent activation temperature.	R/W	-25~25°C, step: 1°C	0°C		
9.1	[C-04]	Bivalent hysteresis temperature.	R/W	2~10°C, step 1°C	3°C		
9.1	[C-05]	What is the thermo request contact type for the main zone?	R/W	0: - 1: 1 contact 2: 2 contacts	2		
9.1	[C-06]	What is the thermo request contact type for the add. zone?	R/W	0: - 1: 1 contact 2: 2 contacts	2		
9.1	[C-07]	What is the unit control method in space operation?	R/W	0: LWT control 1: Ext RT control 2: RT control	0		
9.1	[C-08]	Which type of external sensor is installed?	R/W	0: No 1: Outdoor sensor 2: Room sensor	0		
9.1	[C-09]	What is the required alarm output contact type?	R/W	0: Normally open 1: Normally closed	0		
9.1	[C-0A]	--			0		
9.1	[C-0B]	--			0		

(*1) *6V_(*2) *9W_
 (*3) ETB*(*4) ETV*_
 (*5) *X*(*6) *H*

Field settings table				Installer setting at variance with default value		
Breadcrumb	Field code	Setting name	Range, step	Default value	Date	Official Value
9.1	[C-0C]	--		0		
9.1	[C-0D]	--		0		
9.1	[C-0E]	--		0		
9.1	[D-00]	Which heaters are permitted if prefer. kWh rate PS is cut?	R/W	0: None 1: BSH only 2: BUH only 3: All heaters		
9.1	[D-01]	Contact type of preferential kWh rate PS installation?	R/W	0: No 1: Active open 2: Active closed 3: Safety thermostat		
9.1	[D-02]	Which type of DHW pump is installed?	R/W	0: No DHW pump 1: Instant hot water 2: Disinfection 3: Circulation 4: Circulation and disinfection		
9.1	[D-03]	Leaving water temperature compensation around 0°C.	R/W	0: No 1: increase 2°C, span 4°C 2: increase 4°C, span 4°C 3: increase 2°C, span 8°C 4: increase 4°C, span 8°C		
9.1	[D-04]	Is a demand PCB connected?	R/W	0: No 1: Pwr consmp ctrl		
9.1	[D-05]	Is the pump allowed to run if prefer. kWh rate PS is cut?	R/W	0: Forced off 1: As normal		
9.1	[D-07]	Is a solar kit connected?	R/W	0: No 1: Yes		
9.1	[D-08]	Is an external kWh meter used for power measurement?	R/W	0: No 1: 0,1 pulse/kWh 2: 1 pulse/kWh 3: 10 pulse/kWh 4: 100 pulse/kWh 5: 1000 pulse/kWh		
9.1	[D-09]	Is an external kWh meter used for power measurement?	R/W	0: No 1: 0,1 pulse/kWh 2: 1 pulse/kWh 3: 10 pulse/kWh 4: 100 pulse/kWh 5: 1000 pulse/kWh		
9.1	[D-0A]	--		0		
9.1	[D-0B]	--		2		
9.1	[D-0C]	--		0		
9.1	[D-0D]	--		0		
9.1	[D-0E]	--		0		
9.1	[E-00]	Which type of unit is installed?	R/O	0-5 0: LT split		
9.1	[E-01]	Which type of compressor is installed?	R/O	1		
9.1	[E-02]	What is the indoor unit software type?	R/W (*5) R/O (*6)	0: Reversible (*5) 1: Heating only (*6)		
9.1	[E-03]	What is the number of backup heater steps?	R/O	3: 6V (*1) 4: 9W (*2)		
9.1	[E-04]	Is the power saving function available on the outdoor unit?	R/O	0: No 1: Yes (*3)		
9.1	[E-05]	Can the system prepare domestic hot water?	R/W	0: No (*3) 1: Yes (*4)		
9.1	[E-06]	--		1		
9.1	[E-07]	What kind of DHW tank is installed?	R/W	0-6 0: EKHW (*3) 1: Integrated (*4) 5: EKHW (*3)		
9.1	[E-08]	Power saving function for outdoor unit.	R/W	0: disabled 1: Enabled		
9.1	[E-09]	--		1		
9.1	[E-0B]	Is a bi-zone kit installed?	R/O	0		
9.1	[E-0C]	--		0		
9.1	[E-0D]	Is the system filled with glycol ?	R/W	0: No 1: Yes		
9.1	[E-0E]	--		0		
9.1	[F-00]	Pump operation allowed outside range.	R/W	0: Disabled 1: Enabled		
9.1	[F-01]	Above which outdoor temperature is cooling allowed?	R/W	10-35°C, step: 1°C 20°C		
9.1	[F-02]	--		3		
9.1	[F-03]	--		5		
9.1	[F-04]	--		0		
9.1	[F-05]	--		0		
9.1	[F-09]	Pump operation during flow abnormality.	R/W	0: Disabled 1: Enabled		
9.1	[F-0A]	--		0		
9.1	[F-0B]	Close shut-off valve during thermo OFF?	R/W	0: No 1: Yes		
9.1	[F-0C]	Close shut-off valve during cooling?	R/W	0: No 1: Yes		
9.1	[F-0D]	What is the pump operation mode?	R/W	0: Continuous 1: Sample 2: Request		

(*1) *6V_(*2) *9W_
(*3) ETB*(*4) ETV*_
(*5) *X*_(*6) *H*

(#) Only applicable in Swedish language.

4P586458-1A - 2020.10

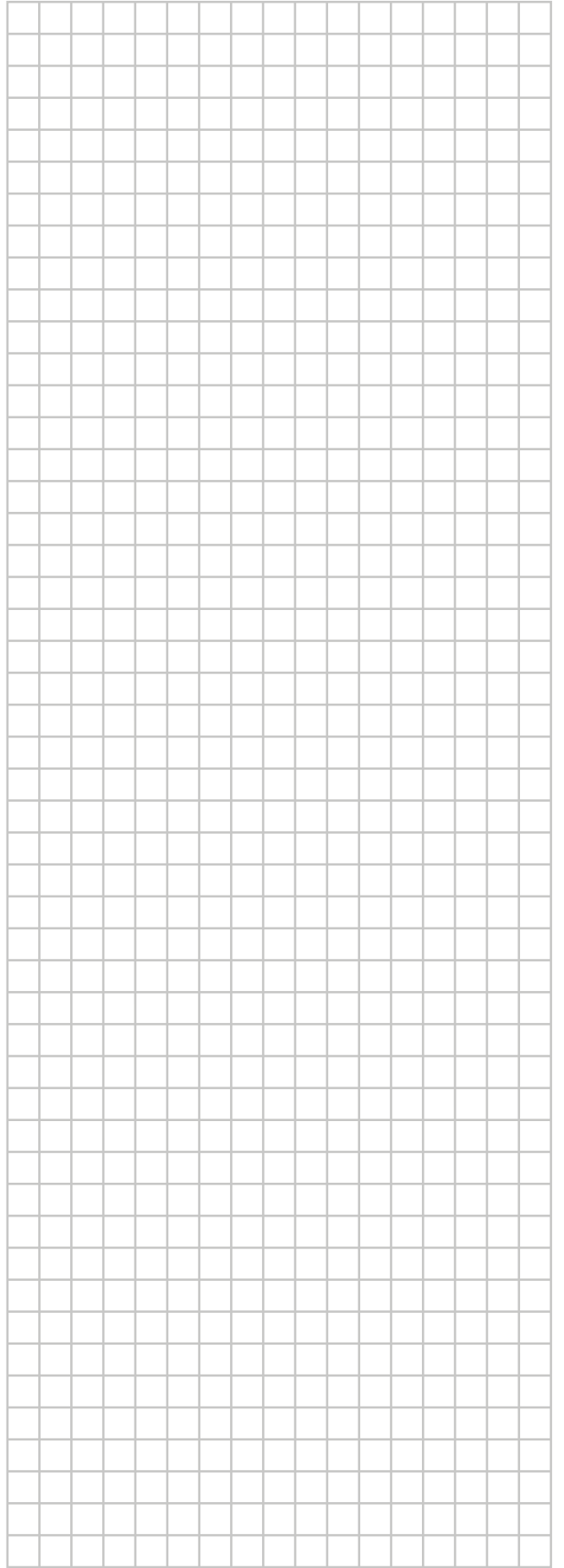

ERC

Copyright 2019 Daikin

DAIKIN EUROPE N.V.
Zandvoordestraat 300, B-8400 Oostende, Belgium

4P587502-1B 2020.12