

**FOR SERVICE PERSONNEL ONLY**

**HITACHI**  
Inspire the Next

**SPLIT UNIT AIR CONDITIONER  
INSTALLATION MANUAL**

**Outdoor Unit** **RAM-40NP2B**

- Carefully read through the procedures of proper installation before starting installation work.
- The sales agent should inform customers regarding the correct operation of installation.

**Tools Needed For Installation Work**

- (Mark is exclusive use tool for R410A)
- Screwdriver • Measuring Tape • Knife
  - Saw •  $\varnothing$  65mm Power Drill • Hexagonal Wrench Key ( $\boxtimes$  4mm) • Wrench (14, 17, 22, 26mm) • Gas Leakage Detector • Pipe Cutter • Putty • Vinyl Tape
  - Pliers • Flare Tool • Vacuum Pump Adapter
  - Manifold Valve • Charge Hose • Vacuum Pump

**SAFETY PRECAUTION**

- Read the safety precautions carefully before operating the unit.
  - The contents of this section are vital to ensure safety. Please pay special attention to the following sign.
    - WARNING** ..... Incorrect methods of installation may cause death or serious injury.
    - CAUTION** ..... Improper installation may result in serious consequence.
    - Make sure to connect earth wire.**
    - This sign in the figures indicates prohibition.**
- Be sure that the unit operates in proper condition after installation. Explain to customer the proper way of operating the unit as described in the user's guide.

**WARNING**

- Please request your sales agent or qualified technician to install your unit. Water leakage, short circuit or fire may occur if you do the installation work yourself.
- Please observe the instructions stated in the installation manual during the process of installation. Improper installation may cause water leakage, electric shock and fire.
- Make sure that the units are mounted at locations which are able to provide full support to the weight of the units. If not, the units may collapse and impose danger.
- Observe the rules and regulations of the electrical installation and the methods described in the installation manual when dealing with the electrical work. Use power cables approved by the authorities of your country.
- Be sure to use the specified wire for connecting the indoor and outdoor units. Please ensure that the connections are tight after the conductors of the wire are inserted into the terminals. Improper insertion and loose contact may cause over-heating and fire.
- Please use the specified components for installation work. Otherwise, the units may collapse or water leakage, electric shock and fire may occur.
- Be sure to use the specified piping set for R-410A. Otherwise, this may result in broken copper pipes or faults.
- When installing or removing an air conditioner, only specified refrigerant (R410A) shall be allowed, do not allow air or moisture to remain in the refrigeration cycle. Otherwise, pressure in the refrigeration cycle may become abnormally high so that a rupture may be caused.
- Be sure to ventilate fully if a refrigerant gas leak while at work. If the refrigerant gas comes into contact with fire, a poisonous gas may occur.
- After completion of installation work, check to make sure that there is no refrigeration gas leakage. If the refrigerant gas leaks into the room, coming into contact with fire in the fan-driven heater, space heater, etc., a poisonous gas may occur.
- Unauthorized modifications to the air conditioner may be dangerous. If a breakdown occurs please call a qualified air conditioner technician or electrician. Improper repairs may result in water leakage, electric shock and fire, etc.
- Be sure to connect the earth wire from the power supply wire to the outdoor unit and between the outdoor and indoor unit. Improper earthing may cause electric shock.

**CAUTION**

- A circuit breaker must be installed in the house distribution box for the direct connected power supply wire to the outdoor unit. In case of other installations a main switch with a contact gap or more than 3.5mm has to be installed. Without a circuit breaker, the danger of electric shock exists.
- Do not install the unit near a location where there is flammable gas. The outdoor unit may catch fire if flammable gas leaks around it. Piping shall be suitable supported with a maximum spacing of 1m between the supports.
- Be sure to tighten the flare nut to the specified torque using a torque wrench. If the flare nut is tightened excessively, it may crack as time elapses, cause refrigerant leakage.
- Please ensure smooth flow of water when installing the drain hose.
- An IEC approved power cord should be used. Power cord type: NYM.

**THE CHOICE OF MOUNTING SITE** (Please note the following matters and obtain permission from customer before installation).

**WARNING**

- The Outdoor unit must be mounted at a location which can support heavy weight. Otherwise, noise and vibration will increase.

**CAUTION**

- Do not expose the unit under direct sunshine or rain. Besides, ventilation must be good and clear of obstruction.
- The air blown out of the unit should not point directly to animals or plants.
- The clearances of the unit from top, left, right and front are specified in figure below. At least 3 of the above sides must be open air.
- Be sure that the hot air blown out of the unit and noise do not disturb the neighbourhood.
- Do not install at a location where there is flammable gas, steam, oil and smoke.
- The location must be convenient for water drainage.
- Place the Outdoor unit and its connecting cord at least 1m away from the antenna or signal line of television, radio or telephone. This is to avoid noise interference.

**Names of Outdoor Components**

**Figure showing the Installation of Outdoor Unit.**

| No. | Item       | Qty |
|-----|------------|-----|
| ⑩   | Bush       | 2   |
| ⑪   | Drain Pipe | 1   |
| ⑫   | Bush       | 1   |

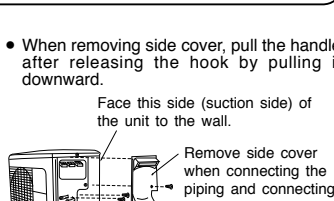
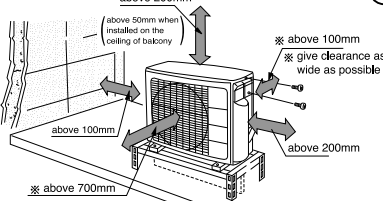
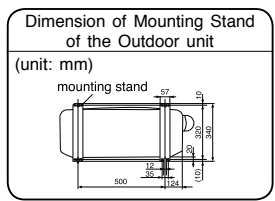
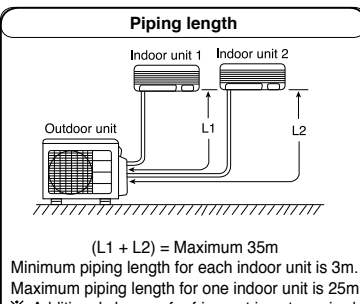
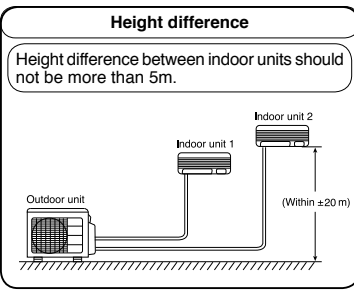

**[Outdoor unit installation]**

- Mount the Outdoor unit on stable ground to prevent vibration and increase of noise level.
- Decide the location for piping after sorting out the different types of pipe available.

**CAUTION**

- Make sure to connect to two indoor units.

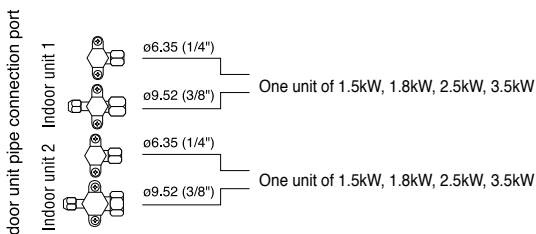

- To the outdoor unit, up to two indoor units can be connected until the total nominal cooling capacity not more than 6.0 kW.
- The pipe connection ports of the outdoor unit and connectable indoor units are shown above.

<A1195: A>

**CONDENSED WATER DISPOSAL OF OUTDOOR UNIT**

- There are holes on the base of Outdoor unit for condensed water to exhaust.
- In order to flow condensed water to the drain, the unit is installed on a stand or a block so that the unit is 100mm above the ground as shown figure. Join the drain pipe to one hole.
- At first insert one portion of the hook to the base (Portion A), then pull the drain pipe in the direction shown by the arrow while inserting the hook into the base. After installation, check whether the drain pipe cling to the base firmly.

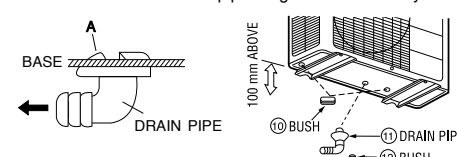

**When Using and Installing in Cold Areas**

- When the air conditioner is used in low temperature and in snowy conditions, water from the heat exchanger may freeze on the base surface to cause poor drainage. When using the air conditioner in such areas, do not install the bushings. Keep a minimum of 250mm between the drain hole and the ground. When using the drain pipe, consult your sales agent.
- For more details, refer to the installation Manual for Cold Areas.

If you wish to prepare the copper tubes and insulation material in the field, we recommend the following.

| No. | Material                          | Specification   |  |
|-----|-----------------------------------|---|--|
| 1   | Copper tube                       | 1.5-3.5kW   | Small dia. Deoxidized annealed copper pipe with 6.35mm O.D., 0.8mm wall thickness. |
|     |                                   |   | Large dia. Deoxidized annealed copper pipe with 9.52mm O.D., 1.0mm wall thickness. |
| 2   | Flare nut                         | 1.5-3.5kW   | Small dia. Flare nuts with 6.35mm O.D..  |
|     |                                   |   | Large dia. Flare nuts with 9.52mm O.D..  |
| 3   | Insulation for refrigerating pipe | Foamed polyethylene insulation pipe which does not corrode the copper tube. <ul style="list-style-type: none"> <li>• Large dia. pipe side: 15mm I.D., 8mm wall thickness.</li> <li>• Small dia. pipe side: 8mm I.D., 7mm wall thickness.</li> </ul> |  |
| 4   | Connecting cord                   | Refer to item 3.3.  |  |
| 5   | Vinyl tape                        |   |  |
| 6   | Sealer (Putty)                    |   |  |
| 7   | Refrigerant oil                   |   |  |
| 8   | Bushing for refrigerating pipes   |   |  |

**1. Proper place for installation**

**1.1 Outdoor unit**

- Keep the space around the unit for maintenance and avoiding the effects of hindrance for normal ventilation of the unit.
- The northern or eastern side of the building is better to install. At the installation on the southern or western side unavoidably, some blind should be set up for the unit. (In this case, the blind must not obstruct the ventilation of the unit.)
- You'd better not put the unit at a place where is full of dirt and at a place where is wet in the rain.
- Place as near as possible to the indoor unit.
- Install the unit in a stable place to minimize vibration or noise.
- After arranging the cords and pipes, secure them in place.

**WARNING**

- This appliance must be earthed.
- Power is supplied through outdoor unit, do not connect power source to indoor unit.

- In the electrical installation a separator with a contact gap of more than 3mm has to be installed. During cleaning or service the set has to be switched off with this separator.

**3. Installation procedure and notice**

Especially, the selection of installation place need great care for the split type air conditioner, because it is very difficult to move from place to place after the first installation.

**3.1 Wiring**

- Connect the electrical wiring between the Indoor and Outdoor unit, as shown in Fig. 3-1. Never connect the wiring by mistake. In case of wrong connection, the unit does not operate properly and it may cause malfunction.
- The connecting cord must be fixed by the band which is located near the terminal board.

**Procedures of Wiring**

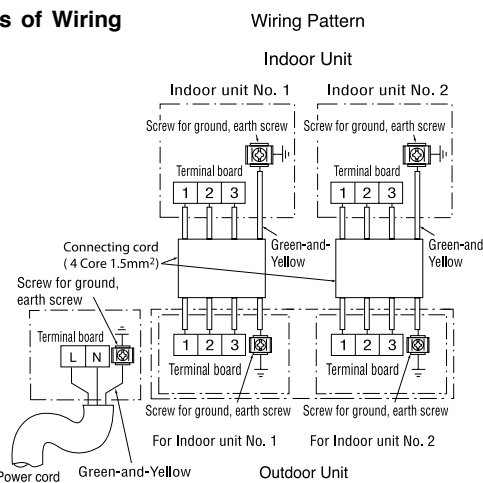

Fig. 3-1

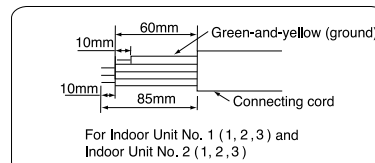
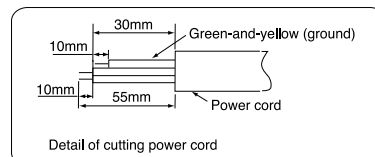

Fig. 3-2

**3.2 Connection of the connecting cords and power cord**

- Cut off the connecting cord, the power cord and strip the insulation of the wire, as shown in Fig. 3-2.
- Connect the connecting cord and power cord to the terminal board. (Fig. 3-3)
- Fix the connecting cords and power cord with steel band certainly. (Fig. 3-3)

**WARNING**

- The naked part of the wire core should be 10 mm and fix it to the terminal tightly. Then try to pull the individual wire to check if the contact is tight. Improper insertion may burn the terminal.
- Be sure to use only power cables approved from the authorities in your country. For example in Germany: Cable type: NYM 3x1.5mm². (fuse = 16A time delay)
- Please refer to the installation manual for wire connection to the terminals of the units. The cabling must meet the standards of electrical installation.
- There is a AC voltage of drop between the L and N terminals. Therefore, before servicing, be sure to switch off the main switch.

**Wiring of The Outdoor Unit**

- Please remove the side cover for wire connection.

**WARNING**

- If you cannot attach the side cover due to the connecting cord, press the connecting cord in direction to the front panel to fix it.
- Be sure that the hooks of the side cover is fixed in certainly. Otherwise water leakage may occur and this causes short circuit or faults.
- The connecting cord should not touch to service valve and pipes. (It becomes high temperature in heating operation.)

**3.3 Checking for the electric source and the voltage range**

- Before installation, the power source must be checked and necessary wiring work must be completed. To make the wiring capacity proper, use the wire gauges list below for the lead-in from a pole transformer and for the wiring from a switch board of fuse box to the main switch and outdoor unit in consideration of the locked rotor current.

**IMPORTANT**

**For (Power cord - L, N, Earth)**

| Cable type | Wire cross-section |
|------------|--------------------|
| 3 Core     | 2.5mm²             |

**For (Connecting cord - 1, 2, 3, Earth)**

| Cable type | Wire cross-section | Cable length |
|------------|--------------------|--------------|
| 4 Core     | 1.5mm²             | up to 25m    |

**WARNING**

- Connect the Connecting Cord to "Indoor 1 (1, 2, 3)" for indoor unit 1, "Indoor 2 (1, 2, 3)" for indoor unit 2.

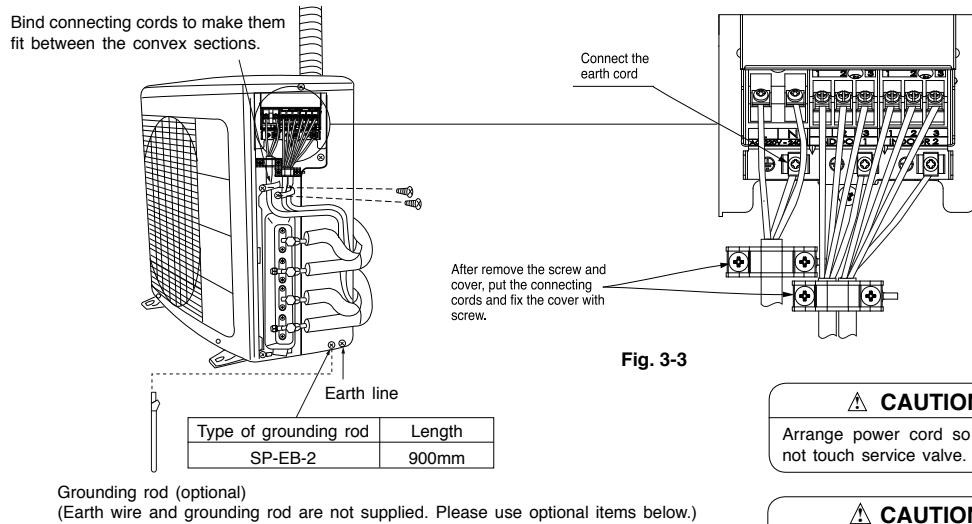

Fig. 3-3

| Type of grounding rod | Length |
|-----------------------|--------|
| SP-EB-2               | 900mm  |

Grounding rod (optional)  
(Earth wire and grounding rod are not supplied. Please use optional items below.)

**CAUTION**

- Arrange power cord so they do not touch service valve.

**CAUTION**

- Note:
  - Outdoor supply cords shall not be lighter than polychloroprene sheathed flexible cord with code designation 60245 IEC 57.

**IMPORTANT**

|                 |
|-----------------|
| Circuit Breaker |
| 16A             |

#### 4. Preparation of Pipe

- Use a pipe cutter to cut the copper pipe.

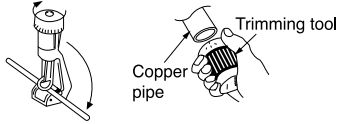

**CAUTION**

- Jagged edge will cause leakage.
- Point the side to be trimmed downwards during trimming to prevent copper chips from entering the pipe.

- Before flaring, please put on the flare nut.

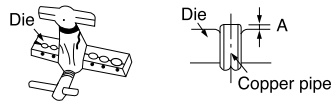

- Recommend to use R410A flaring tool.

| Outer Diameter (Ø) | A (mm)         |              |
|--------------------|----------------|--------------|
|                    | For R410A tool | For R22 tool |
| 6.35 (1/4")        | 0 ~ 0.5mm      | 1.0mm        |
| 9.52 (3/8")        | 0 ~ 0.5mm      | 1.0mm        |

#### 5. Pipe Connection

##### 5.1 Pipe connection Connecting the pipe to outdoor unit

- Remove the flare nut and seal cap from the service valve.
- Apply refrigerator oil to the service valve and the flared portion of the pipe.
- Using a wrench, security tighten.

Tighten all the way by hand.  
Do not tighten all at once, but tighten it while fitting the flared surface to the pipe.

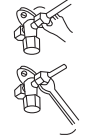

**CAUTION**

- In case of removing flare nut of an indoor unit, first remove a nut of small diameter side, or seal cap of large diameter side will fly out. Free from water into the piping when working.
- During connection, keep away from water.
- Be sure to tighten the flare nut to the specified torque using a torque wrench. If the flare nut is tightened excessively, it may crack as time elapses, causing refrigerant leakage.

- Please be careful when bending the copper pipe.
- Screw in manually while adjusting the center. After that, use of torque wrench to tighten the connection.

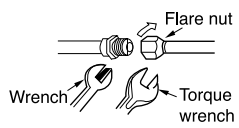

|                     | Outer diameter of pipe (Ø) | Torque N·m (kgf·cm) |
|---------------------|----------------------------|---------------------|
| Small diameter side | 6.35 (1/4")                | 13.7-18.6 (140-190) |
| Large diameter side | 9.52 (3/8")                | 34.3-44.1 (350-450) |
| Valve head cap      | Small diameter side        | 6.35 (1/4")         |
|                     | Large diameter side        | 9.52 (3/8")         |
| Valve core cap      |                            | 12.3-15.7 (125-160) |

- Install the unit in a stable place to minimize vibration or noise.
- After arranging the cords and pipes, secure them in place.

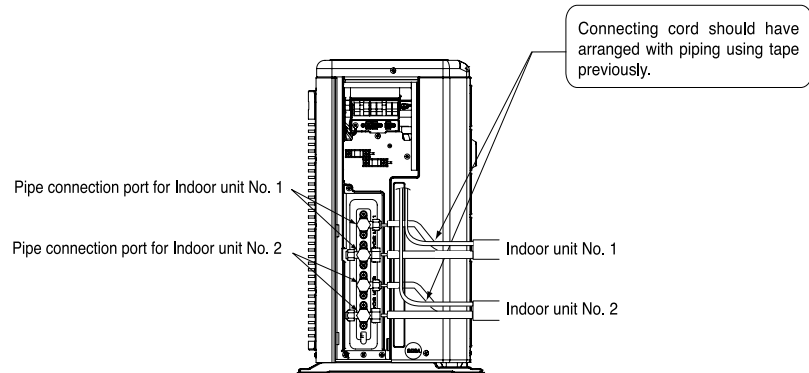

**Gas leakage inspection**

Please use gas leakage detector to check if leakage occurs at connection of flare nut as shown on the right. If gas leakage occurs, further tighten the connection to stop leakage. (Use the detector provided for R410A)

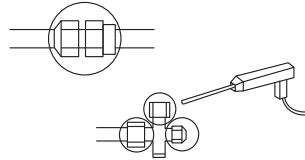

#### 6. Removal Of Air From The Pipe And Gas Leakage Inspection

##### 6.1 Air purging by using vacuum pump

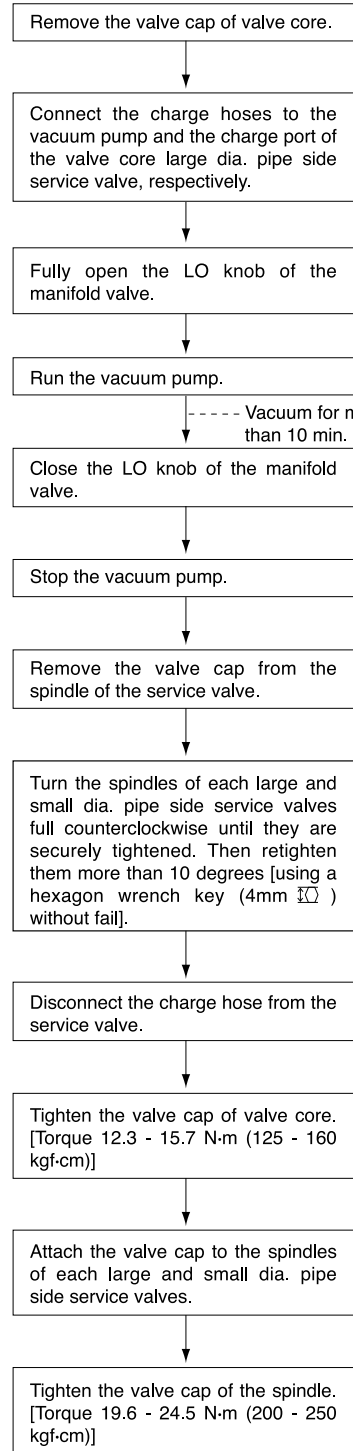

##### Air purging by vacuum pump

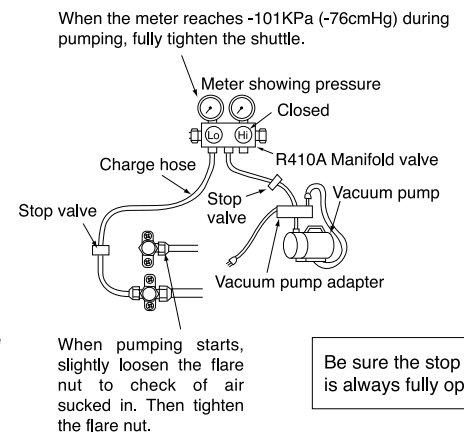

Fig. 6-1

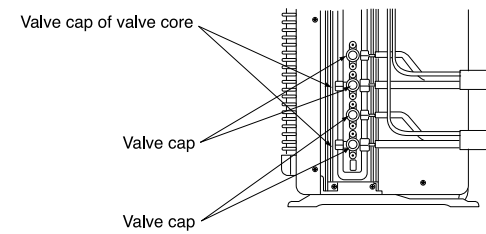

Fig. 6-2

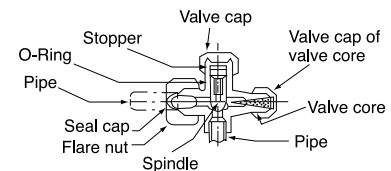

Fig. 6-3

The refrigerant channel is opened so that the refrigerant will flow from the outdoor unit into the indoor unit.

#### 7. Operation test

- Please ensure that the air conditioner is in normal operating condition during the operation test.
- Explain to your customer the proper operation procedures as described in the user's manual.
- If the indoor unit does not operate, check to see that the connections are correct.

**CAUTION**

- Trial run should be conducted on one unit at a time to check for incorrect wiring of connecting cord.