

Air Conditioning Technical Data

RXYQ-U



- > RXYQ8U7Y1B
- > RXYQ10U7Y1B
- > RXYQ12U7Y1B
- > RXYQ14U7Y1B
- > RXYQ16U7Y1B
- > RXYQ18U7Y1B

- > RXYQ20U7Y1B

TABLE OF CONTENTS

RXYQ-U

| | | |
|----|--|----|
| 1 | Features | 2 |
| 2 | Specifications | 3 |
| | Technical Specifications | 3 |
| | Electrical Specifications | 6 |
| | Technical Specifications | 7 |
| | Technical Specifications | 10 |
| | Electrical Specifications | 13 |
| | Electrical Specifications | 13 |
| 3 | Options | 15 |
| 4 | Combination table | 16 |
| 5 | Capacity tables | 19 |
| | Capacity Table Legend | 19 |
| | Capacity Correction Factor | 20 |
| 6 | Dimensional drawings | 33 |
| 7 | Centre of gravity | 34 |
| 8 | Piping diagrams | 35 |
| 9 | Wiring diagrams | 36 |
| | Wiring Diagrams - Single Phase | 36 |
| 10 | External connection diagrams | 40 |
| 11 | Sound data | 42 |
| | Sound Power Spectrum | 42 |
| | Sound Pressure Spectrum | 46 |
| | Sound Pressure Spectrum Quiet Mode | 50 |
| 12 | Installation | 55 |
| | Installation Method | 55 |
| | Fixation and Foundation of Units | 56 |
| | Refrigerant Pipe Selection | 57 |
| 13 | Operation range | 60 |
| 14 | Appropriate Indoors | 61 |

1 Features

Daikin's solution for comfort & low energy consumption

- Covers all thermal needs of a building via a single point of contact: accurate temperature control, ventilation, hot water, air handling units and Biddle air curtains
- Wide range of indoor units: possibility to combine VRV with stylish indoor units (Daikin Emura, Nexura, ...)
- Incorporates VRV IV standards & technologies: Variable Refrigerant Temperature, VRV configurator, 7 segment display and full inverter compressors, 4-side heat exchanger, refrigerant cooled PCB, new DC fan motor, ...
- Customize your VRV for best seasonal efficiency & comfort with the weather dependant Variable Refrigerant Temperature function. Increased seasonal efficiency with up to 28%. No more cold draft by supply of high outblow temperatures
- VRV configurator software for the fastest and most accurate commissioning, configuration and customisation
- Outdoor unit display for quick on-site settings and easy read out of errors together with the indication of service parameters for checking basic functions.
- Free combination of outdoor units to meet installation space or efficiency requirements
- Fits any building as also indoor installation is possible as a result of high external static pressure of up to 78.4 Pa. Indoor installation leads to less piping length, lower installation costs, increased efficiency and better visual aesthetics
- Simplified installation & guaranteed optimal efficiency with automatic charging & testing
- Easy compliance with F-gas regulation thanks to automated refrigerant containment check
- Wide piping flexibility: 30m indoor height difference, maximum piping length: 190m, total piping length: 1,000m
- The ability to control each conditioned zone individually keeps VRV system running costs to an absolute minimum
- Spread your installation cost by phased installation
- Keep your system in top condition via the Daikin Cloud Service: 24/7 monitoring for maximum efficiency, extended lifetime and immediate service support thanks to failure prediction
- Available as heating only by irreversible field setting



Inverter

2 Specifications

| 2-1 Technical Specifications | | | | RXYQ8U | RXYQ10U | RXYQ12U | RXYQ14U | RXYQ16U | RXYQ18U | RXYQ20U |
|--|------------------|---------|-------|---------------------------------------|------------------------|------------------------|---|---|---|---|
| Recommended combination | | | | 4 x FXFQ50AV EB | 4 x FXFQ63AV EB | 6 x FXFQ50AV EB | 1 x FXFQ50AV EB + 5 x FXFQ63AV EB | 4 x FXFQ63AV EB + 2 x FXFQ80AV EB | 3 x FXFQ50AV EB + 5 x FXFQ63AV EB | 2 x FXFQ50AV EB + 6 x FXFQ63AV EB |
| Recommended combination 2 | | | | 4 x FXSQ50A2 VEB | 4 x FXSQ63A2 VEB | 6 x FXSQ50A2 VEB | 1 x FXSQ50A2 VEB + 5 x FXSQ63A2 VEB | 4 x FXSQ63A2 VEB + 2 x FXSQ80A2 VEB | 3 x FXSQ50A2 VEB + 5 x FXSQ63A2 VEB | 2 x FXSQ50A2 VEB + 6 x FXSQ63A2 VEB |
| Recommended combination 3 | | | | 4 x FXMQ50P7 VEB | 4 x FXMQ63P7 VEB | 6 x FXMQ50P7 VEB | 1 x FXMQ50P7 VEB + 5 x FXMQ63P7 VEB | 4 x FXMQ63P7 VEB + 2 x FXMQ80P7 VEB | 3 x FXMQ50P7 VEB + 5 x FXMQ63P7 VEB | 2 x FXMQ50P7 VEB + 6 x FXMQ63P7 VEB |
| Cooling capacity | Prated,c | | kW | 22.4 (1) | 28.0 (1) | 33.5 (1) | 40.0 (1) | 45.0 (1) | 50.4 (1) | 52.0 (1) |
| Heating capacity | Prated,h | | kW | 13.7 | 16.0 | 18.4 | 20.6 | 23.2 | 27.9 | 31.0 |
| | Max. | 6°CWB | kW | 25.0 (2) | 31.5 (2) | 37.5 (2) | 45.0 (2) | 50.0 (2) | 56.5 (2) | 63.0 (2) |
| SEER | | | | 7.6 | 6.8 | 6.3 | | 6.0 | | 5.9 |
| SEER recommended combination 2 | | | | 6.9 | 6.8 | 5.9 | 6.3 | 5.9 | 6.0 | 5.9 |
| SEER recommended combination 3 | | | | 7.5 | 6.8 | 6.2 | | 5.8 | 6.0 | 5.9 |
| SCOP | | | | 4.3 | | 4.1 | 4.0 | | 4.2 | 4.0 |
| SCOP recommended combination 2 | | | | 4.2 | 4.3 | 4.1 | 4.0 | 4.1 | 4.2 | 4.0 |
| SCOP recommended combination 3 | | | | 4.2 | 4.1 | | 4.0 | | 4.1 | 3.9 |
| ηs,c | | | % | 302.4 | 267.6 | 247.8 | 250.7 | 236.5 | 238.3 | 233.7 |
| ηs,c recommended combination 2 | | | | 273.6 | 270.5 | 233.5 | 250.0 | 234.2 | 236.8 | 233.9 |
| ηs,c recommended combination 3 | | | | 295.2 | 267.1 | 246.3 | 246.7 | 230.4 | 238.2 | 233.1 |
| ηs,h | | | % | 167.9 | 168.2 | 161.4 | 155.4 | 157.8 | 163.1 | 156.6 |
| ηs,h recommended combination 2 | | | | 165.4 | 170.6 | 161.3 | 157.2 | 159.5 | 164.8 | 158.2 |
| ηs,h recommended combination 3 | | | | 165.6 | 162.0 | 160.6 | 155.7 | 156.8 | 159.6 | 153.4 |
| Capacity range | | | HP | 8 | 10 | 12 | 14 | 16 | 18 | 20 |
| Maximum number of connectable indoor units | | | | 64 (3) | | | | | | |
| Indoor index connection | Min. | | | 100.0 | 125.0 | 150.0 | 175.0 | 200.0 | 225.0 | 250.0 |
| | Max. | | | 260.0 | 325.0 | 390.0 | 455.0 | 520.0 | 585.0 | 650.0 |
| Dimensions | Unit | Height | mm | 1,685 | | | | | | |
| | | Width | mm | 930 | | | 1,240 | | | |
| | | Depth | mm | 765 | | | | | | |
| | Packed unit | Height | mm | 1,820 | | | | | | |
| | | Width | mm | 995 | | | 1,305 | | | |
| | | Depth | mm | 860 | | | | | | |
| Weight | Unit | | kg | 198 | | | 275 | | 308 | |
| | Packed unit | | kg | 211 | | | 291 | | 324 | |
| Packing | Material | | | Carton | | | | | | |
| | Weight | | | kg | 1.8 | | | 2.2 | | |
| Packing 2 | Material | | | Wood | | | | | | |
| | Weight | | | kg | 11.0 | | | 14.0 | | |
| Packing 3 | Material | | | Plastic | | | | | | |
| | Weight | | | kg | 0.5 | | | 0.6 | | |
| Capacity control | Method | | | Inverter controlled | | | | | | |
| Casing | Colour | | | Daikin White | | | | | | |
| | Material | | | Painted galvanized steel plate | | | | | | |
| Heat exchanger | Type | | | Cross fin coil | | | | | | |
| | Indoor side | | | Air | | | | | | |
| | Outdoor side | | | Air | | | | | | |
| | Air flow rate | Cooling | Rated | m³/h | 9,720 | 10,500 | 11,100 | 13,380 | 15,600 | 15,060 |
| Heating | | Rated | m³/h | 9,720 | 10,500 | 11,100 | 13,380 | 15,600 | 15,060 | 15,660 |
| Compressor | Quantity | | | 1 | | | 2 | | | |
| | Type | | | Hermetically sealed scroll compressor | | | | | | |
| | Crankcase heater | | | W | 33 | | | | | |

2 Specifications

| 2-1 Technical Specifications | | | | RXYQ8U | RXYQ10U | RXYQ12U | RXYQ14U | RXYQ16U | RXYQ18U | RXYQ20U |
|---|----------------------------|-----------|--------------------|-------------------------------|----------|----------|----------|----------|----------|----------|
| Fan | Quantity | | | 1 | | | 2 | | | |
| | External static pressure | Max. | Pa | 78 | | | | | | |
| Fan motor | Quantity | | | 1 | | | 2 | | | |
| | Type | | | DC motor | | | | | | |
| | Output | | W | 550 | | | 750 | | | |
| Sound power level | Cooling | Nom. | dBA | 78.0 (4) | 79.1 (4) | 83.4 (4) | 80.9 (4) | 85.6 (4) | 83.8 (4) | 87.9 (4) |
| | Heating | Nom. | dBA | 62.7 (4) | 64.8 (4) | 64.9 (4) | 68.3 (4) | 68.6 (4) | 66.3 (4) | 67.0 (4) |
| Sound pressure level | Cooling | Nom. | dBA | 57.0 (5) | | 61.0 (5) | 60.0 (5) | 63.0 (5) | 62.0 (5) | 65.0 (5) |
| Operation range | Cooling | Min.~Max. | °CDB | -5.0~43.0 | | | | | | |
| | Heating | Min.~Max. | °CWB | -20.0~15.5 | | | | | | |
| Refrigerant | Type | | | R-410A | | | | | | |
| | GWP | | | 2,087.5 | | | | | | |
| | Charge | | TCO _{2eq} | 12.3 | 12.5 | 13.2 | 21.5 | 23.6 | 24.4 | 24.6 |
| | | | kg | 5.9 | 6.0 | 6.3 | 10.3 | 11.3 | 11.7 | 11.8 |
| Refrigerant oil | Type | | | Synthetic (ether) oil FVC68D | | | | | | |
| Piping connections | Liquid | Type | | Braze connection | | | | | | |
| | | OD | mm | 9,52 | | 12,7 | | 15,9 | | |
| | Gas | Type | | Braze connection | | | | | | |
| | | OD | mm | 19.1 | 22.2 | 28.6 | | | | |
| Total piping length | System | Actual | m | 1,000 (6) | | | | | | |
| Defrost method | | | | Reversed cycle | | | | | | |
| Safety devices | Item | 01 | | High pressure switch | | | | | | |
| | | 02 | | Fan driver overload protector | | | | | | |
| | | 03 | | Inverter overload protector | | | | | | |
| | | 04 | | PC board fuse | | | | | | |
| | | 05 | | Leakage current detector | | | | | | |
| PED | Category | | | Category II | | | | | | |
| | Most critical part | Name | | Accumulator | | | | | | |
| | | Ps*V | Bar*l | 325 | | | 415 | | 493 | |
| Space cooling | A Condition (35°C - 27/19) | EERd | | 3.0 | 2.3 | 2.4 | 2.6 | 2.1 | 1.9 | |
| | | Pdc | kW | 22.4 | 28.0 | 33.5 | 40.0 | 45.0 | 50.4 | 52.0 |
| | B Condition (30°C - 27/19) | EERd | | 5.2 | 4.7 | 4.3 | 4.1 | 3.9 | 3.8 | 3.7 |
| | | Pdc | kW | 16.5 | 20.6 | 24.7 | 29.5 | 33.2 | 37.1 | 38.3 |
| | C Condition (25°C - 27/19) | EERd | | 9.5 | 8.3 | 7.7 | 7.8 | 7.7 | 7.5 | 7.3 |
| | | Pdc | kW | 10.6 | 13.3 | 15.9 | 18.9 | 21.3 | 23.9 | 24.6 |
| | D Condition (20°C - 27/19) | EERd | | 18.8 | 17.0 | 13.9 | 14.3 | 14.2 | 18.3 | |
| | | Pdc | kW | 8.0 | 9.3 | 9.4 | 8.4 | 9.5 | 11.5 | |
| Space cooling recommended combination 2 | A Condition (35°C - 27/19) | EERd | | 2.6 | 2.4 | | 2.6 | 2.1 | 1.9 | |
| | | Pdc | kW | 22.4 | 28.0 | 33.5 | 40.0 | 45.0 | 50.4 | 52.0 |
| | B Condition (30°C - 27/19) | EERd | | 4.9 | 4.7 | 4.0 | 4.1 | 3.8 | 3.7 | 3.6 |
| | | Pdc | kW | 16.5 | 20.6 | 24.7 | 29.5 | 33.2 | 37.1 | 38.3 |
| | C Condition (25°C - 27/19) | EERd | | 8.8 | 8.5 | 7.1 | 7.9 | 7.6 | 7.5 | 7.3 |
| | | Pdc | kW | 10.6 | 13.3 | 15.9 | 18.9 | 21.3 | 23.9 | 24.6 |
| | D Condition (20°C - 27/19) | EERd | | 15.1 | 17.2 | 13.1 | 14.0 | | 18.1 | 18.9 |
| | | Pdc | kW | 8.8 | 9.3 | 9.1 | 8.4 | 9.5 | 11.4 | 10.9 |
| Space cooling recommended combination 3 | A Condition (35°C - 27/19) | EERd | | 3.0 | 2.3 | 2.4 | 2.6 | 2.1 | 1.9 | |
| | | Pdc | kW | 22.4 | 28.0 | 33.5 | 40.0 | 45.0 | 50.4 | 52.0 |
| | B Condition (30°C - 27/19) | EERd | | 5.1 | 4.7 | 4.2 | 4.0 | 3.7 | | 3.6 |
| | | Pdc | kW | 16.5 | 20.6 | 24.7 | 29.5 | 33.2 | 37.1 | 38.3 |
| | C Condition (25°C - 27/19) | EERd | | 9.6 | 8.4 | 7.7 | | 7.4 | 7.6 | 7.3 |
| | | Pdc | kW | 10.6 | 13.3 | 15.9 | 19.0 | 21.3 | 23.9 | 24.6 |
| | D Condition (20°C - 27/19) | EERd | | 16.0 | 16.9 | 13.7 | 14.0 | 14.1 | 18.3 | |
| | | Pdc | kW | 9.1 | 9.3 | 9.4 | 8.4 | 9.5 | 11.6 | |

2 Specifications

| 2-1 Technical Specifications | | | RXYQ8U | RXYQ10U | RXYQ12U | RXYQ14U | RXYQ16U | RXYQ18U | RXYQ20U | |
|--|--------------------|-----------------------------------|--------|---------|---------|---------|---------|---------|---------|------|
| Space heating (Average climate) | TBivalent | COPd (declared COP) | 2.5 | 2.4 | 2.0 | 2.3 | 2.2 | 1.9 | 1.8 | |
| | | Pdh (declared heating cap) | kW | 13.7 | 16.0 | 18.4 | 20.6 | 23.2 | 27.9 | 31.0 |
| | | Tbiv (bivalent temperature) | °C | -10 | | | | | | |
| | TOL | COPd (declared COP) | 2.5 | 2.4 | 2.0 | 2.3 | 2.2 | 1.9 | 1.8 | |
| | | Pdh (declared heating cap) | kW | 13.7 | 16.0 | 18.4 | 20.6 | 23.2 | 27.9 | 31.0 |
| | | Tol (temperature operating limit) | °C | -10 | | | | | | |
| | A Condition (-7°C) | COPd (declared COP) | 2.7 | 2.6 | 2.4 | 2.6 | | 2.4 | 2.1 | |
| | | Pdh (declared heating cap) | kW | 12.1 | 14.2 | 16.3 | 18.2 | 20.5 | 24.7 | 27.4 |
| | B Condition (2°C) | COPd (declared COP) | 3.9 | | | 3.5 | | 3.7 | 3.6 | |
| | | Pdh (declared heating cap) | kW | 7.4 | 8.6 | 9.9 | 11.1 | 12.5 | 15.0 | 16.7 |
| | C Condition (7°C) | COPd (declared COP) | 6.3 | 6.4 | 6.1 | | 6.3 | 6.7 | 6.5 | |
| | | Pdh (declared heating cap) | kW | 5.0 | 5.5 | 6.4 | 7.1 | 8.0 | 9.7 | 10.7 |
| | D Condition (12°C) | COPd (declared COP) | 7.9 | 8.2 | 7.9 | 8.5 | 8.6 | 9.0 | 9.1 | |
| | | Pdh (declared heating cap) | kW | 5.9 | | 6.3 | 4.9 | | 7.1 | |
| Space heating (Average climate) recommended combination 2 | A Condition (-7°C) | COPd (declared COP) | 2.7 | | 2.4 | 2.6 | | 2.4 | 2.2 | |
| | | Pdh (declared heating cap) | kW | 12.1 | 14.2 | 16.3 | 18.2 | 20.5 | 24.7 | 27.4 |
| | B Condition (2°C) | COPd (declared COP) | 3.9 | 4.0 | 3.9 | 3.5 | | 3.8 | 3.7 | |
| | | Pdh (declared heating cap) | kW | 7.4 | 8.6 | 9.9 | 11.1 | 12.2 | 15.0 | 16.7 |
| | C Condition (7°C) | COPd (declared COP) | 6.3 | 6.5 | 6.1 | | 6.3 | 6.8 | 6.5 | |
| | | Pdh (declared heating cap) | kW | 5.0 | 5.5 | 6.4 | 7.1 | 8.0 | 9.7 | 10.7 |
| | D Condition (12°C) | COPd (declared COP) | 7.8 | 8.3 | 7.9 | 8.6 | 8.7 | 9.1 | 9.2 | |
| | | Pdh (declared heating cap) | kW | 5.9 | 6.0 | 6.4 | 4.9 | 5.0 | 7.2 | |
| | TBivalent | COPd (declared COP) | 2.4 | | 1.9 | 2.3 | 2.2 | 1.9 | 1.8 | |
| | | Pdh (declared heating cap) | kW | 13.7 | 16.0 | 18.4 | 20.6 | 23.2 | 27.9 | 31.0 |
| | | Tbiv (bivalent temperature) | °C | -10 | | | | | | |
| | TOL | COPd (declared COP) | 2.4 | | 1.9 | 2.3 | 2.2 | 1.9 | 1.8 | |
| | | Pdh (declared heating cap) | kW | 13.7 | 16.0 | 18.4 | 20.6 | 23.2 | 27.9 | 31.0 |
| | | Tol (temperature operating limit) | °C | -10 | | | | | | |

2 Specifications

2

| 2-1 Technical Specifications | | | | RXYQ8U | RXYQ10U | RXYQ12U | RXYQ14U | RXYQ16U | RXYQ18U | RXYQ20U |
|--|---------------------------|-----------------------------|------|--------|---------|---------|---------|---------|---------|---------|
| Space heating (Average climate) recommended combination 3 | A Condition (-7°C) | COPd (declared COP) | | 2.7 | 2.6 | 2.4 | 2.6 | | 2.4 | 2.1 |
| | | Pdh (declared heating cap) | kW | 12.1 | 14.2 | 16.3 | 18.2 | 20.5 | 24.7 | 27.4 |
| | B Condition (2°C) | COPd (declared COP) | | 3.9 | 3.7 | 3.9 | 3.5 | | 3.7 | 3.6 |
| | | Pdh (declared heating cap) | kW | 7.4 | 8.6 | 9.9 | 11.1 | 12.5 | 15.0 | 16.7 |
| | C Condition (7°C) | COPd (declared COP) | | 6.2 | 6.4 | 6.0 | 6.1 | 6.2 | 6.5 | 6.3 |
| | | Pdh (declared heating cap) | kW | 4.9 | 5.5 | 6.4 | 7.1 | 8.0 | 9.7 | 10.7 |
| | D Condition (12°C) | COPd (declared COP) | | 7.8 | 8.1 | 7.8 | 8.5 | 8.6 | 8.7 | |
| | | Pdh (declared heating cap) | kW | 5.8 | 5.9 | 6.2 | 4.9 | | 6.9 | |
| | TBivalent | COPd (declared COP) | | 2.5 | 2.4 | 2.0 | 2.3 | 2.2 | 1.9 | 1.8 |
| | | Pdh (declared heating cap) | kW | 13.7 | 16.0 | 18.4 | 20.6 | 23.2 | 27.9 | 31.0 |
| | | Tbiv (bivalent temperature) | °C | -10 | | | | | | |
| | TOL | COPd (declared COP) | | 2.5 | 2.4 | 2.0 | 2.3 | 2.2 | 1.9 | 1.8 |
| Pdh (declared heating cap) | | kW | 13.7 | 16.0 | 18.4 | 20.6 | 23.2 | 27.9 | 31.0 | |
| Tol (temperature operating limit) | | °C | -10 | | | | | | | |
| Cooling | Cdc (Degradation cooling) | | | 0.25 | | | | | | |
| Heating | Cdh (Degradation heating) | | | 0.25 | | | | | | |
| Power consumption in other than active mode | Crankcase heater mode | Cooling | PCK | kW | 0.000 | | | | | |
| | | Heating | PCK | kW | 0.052 | 0.077 | 0.089 | | | |
| | Off mode | Cooling | POFF | kW | 0.041 | 0.074 | 0.075 | | | |
| | | Heating | POFF | kW | 0.052 | 0.077 | 0.089 | | | |
| | Standby mode | Cooling | PSB | kW | 0.041 | 0.074 | 0.075 | | | |
| | | Heating | PSB | kW | 0.052 | 0.077 | 0.089 | | | |
| | Thermostat-off mode | Cooling | PTO | kW | 0.005 | 0.010 | | | | |
| | | Heating | PTO | kW | 0.056 | 0.097 | 0.098 | | | |
| Indication if the heater is equipped with a supplementary heater | | | | no | | | | | | |
| Supplementary heater | Back-up capacity | Heating | elbu | kW | 0.0 | | | | | |

Standard Accessories : Installation manual; Quantity : 1;

Standard Accessories : Operation manual; Quantity : 1;

Standard Accessories : Connection pipes; Quantity : 1;

| 2-2 Electrical Specifications | | | | RXYQ8U | RXYQ10U | RXYQ12U | RXYQ14U | RXYQ16U | RXYQ18U | RXYQ20U |
|-------------------------------|--------------------------------------|----------|---|------------------------------|----------|----------|----------|----------|----------|----------|
| Power supply | Name | | | Y1 | | | | | | |
| | Phase | | | 3N~ | | | | | | |
| | Frequency | Hz | | 50 | | | | | | |
| | Voltage | V | | 380-415 | | | | | | |
| Voltage range | Min. | % | | -10 | | | | | | |
| | Max. | % | | 10 | | | | | | |
| Current | Nominal running current (RLA) - 50Hz | Cooling | A | 7.2 (7) | 10.2 (7) | 12.7 (7) | 15.4 (7) | 18.0 (7) | 20.8 (7) | 26.9 (7) |
| Current - 50Hz | Starting current (MSC) - remark | | | (8) | | | | | | |
| | Zmax | List | | No requirements | | | | | | |
| | Minimum circuit amps (MCA) | A | | 16.1 (9) | 22.0 (9) | 24.0 (9) | 27.0 (9) | 31.0 (9) | 35.0 (9) | 39.0 (9) |
| | Maximum fuse amps (MFA) | A | | 20 (10) | 25 (10) | 32 (10) | | 40 (10) | | 50 (10) |
| | Full load amps (FLA) | Total | A | 1.2 (11) | 1.3 (11) | 1.5 (11) | 1.8 (11) | 2.6 (11) | | |
| Wiring connections - 50Hz | For power supply | Quantity | | 5G | | | | | | |
| | For connection with indoor | Quantity | | 2 | | | | | | |
| | | Remark | | F1,F2 | | | | | | |
| Power supply intake | | | | Both indoor and outdoor unit | | | | | | |

2 Specifications

Notes

- (1) Cooling: indoor temp. 27°CDB, 19°CWB; outdoor temp. 35°CDB; equivalent piping length: 7.5m; level difference: 0m
- (2) Heating: indoor temp. 20°CDB; outdoor temp. 7°CDB, 6°CWB; equivalent refrigerant piping: 7.5m; level difference: 0m
- (3) Actual number of connectable indoor units depends on the indoor unit type (VRV indoor, Hydrobox, RA indoor, etc.) and the connection ratio restriction for the system (50% ≤ CR ≤ 130%)
- (4) Sound power level is an absolute value that a sound source generates.
- (5) Sound pressure level is a relative value, depending on the distance and acoustic environment. For more details, please refer to the sound level drawings.
- (6) Refer to refrigerant pipe selection or installation manual
- (7) RLA is based on following conditions: indoor temp. 27°CDB, 19°CWB; outdoor temp. 35°CDB
- (8) MSC means the maximum current during start up of the compressor. VRV IV uses only inverter compressors. Starting current is always ≤ max. running current.
- (9) MCA must be used to select the correct field wiring size. The MCA can be regarded as the maximum running current.
- (10) MFA is used to select the circuit breaker and the ground fault circuit interrupter (earth leakage circuit breaker).
- (11) FLA means the nominal running current of the fan

In accordance with EN/IEC 61000-3-12, it may be necessary to consult the distribution network operator to ensure that the equipment is connected only to a supply with Ssc ≥ minimum Ssc value

Maximum allowable voltage range variation between phases is 2%.

Voltage range: units are suitable for use on electrical systems where voltage supplied to unit terminal is not below or above listed range limits.

The AUTOMATIC ESEER value corresponds with normal VRV4 Heat Pump operation, taking into account advanced energy saving operation functionality (variable refrigerant temperature)

The STANDARD ESEER value corresponds with normal VRV4 Heat Pump operation, not taking into account advanced energy saving operation functionality

Sound values are measured in a semi-anechoic room.

Soundpressure system [dBA] = 10*log[10^(A/10)+10^(B/10)+10^(C/10)] , with Unit A = A dBA, Unit B = B dBA, Unit C = C dBA

EN/IEC 61000-3-12: European/international technical standard setting the limits for harmonic currents produced by equipment connected to public low-voltage system with input current I > 16A and ≤ 75A per phase

Ssc: Short-circuit power

For detailed contents of standard accessories, see installation/operation manual

Multi combination (22~54HP) data is corresponding with the standard multi combination

| 2-3 Technical Specifications | | RXYQ22U | RXYQ24U | RXYQ26U | RXYQ28U | RXYQ30U | RXYQ32U | RXYQ34U | RXYQ36U | RXYQ38U |
|------------------------------|-----------------------|--|--|--|--|--|--|--|---|---|
| System | Outdoor unit module 1 | RXYQ10 U | RXYQ8U | RXYQ12U | | | RXYQ16U | | | RXYQ8U |
| | Outdoor unit module 2 | RXYQ12 U | RXYQ16 U | RXYQ14 U | RXYQ16 U | RXYQ18 U | RXYQ16 U | RXYQ18 U | RXYQ20 U | RXYQ10 U |
| | Outdoor unit module 3 | | | | | | | | | RXYQ20 U |
| Recommended combination | | 6 x FXFQ50 AVEB + 4 x FXFQ63 AVEB | 4 x FXFQ50 AVEB + 4 x FXFQ63 AVEB + 2 x FXFQ80 AVEB | 7 x FXFQ50 AVEB + 5 x FXFQ63 AVEB | 6 x FXFQ50 AVEB + 4 x FXFQ63 AVEB + 2 x FXFQ80 AVEB | 9 x FXFQ50 AVEB + 5 x FXFQ63 AVEB | 8 x FXFQ63 AVEB + 4 x FXFQ80 AVEB | 3 x FXFQ50 AVEB + 9 x FXFQ63 AVEB + 2 x FXFQ80 AVEB | 2 x FXFQ50 AVEB + 10 x FXFQ63 AVEB + 2 x FXFQ80 AVEB | 6 x FXFQ50 AVEB + 10 x FXFQ63 AVEB |
| Recommended combination 2 | | 6 x FXSQ50 A2VEB + 4 x FXSQ63 A2VEB | 4 x FXSQ50 A2VEB + 4 x FXSQ63 A2VEB + 2 x FXSQ80 A2VEB | 7 x FXSQ50 A2VEB + 5 x FXSQ63 A2VEB | 6 x FXSQ50 A2VEB + 4 x FXSQ63 A2VEB + 2 x FXSQ80 A2VEB | 9 x FXSQ50 A2VEB + 5 x FXSQ63 A2VEB | 8 x FXSQ63 A2VEB + 4 x FXSQ80 A2VEB | 3 x FXSQ50 A2VEB + 9 x FXSQ63 A2VEB + 2 x FXSQ80 A2VEB | 2 x FXSQ50 A2VEB + 10 x FXSQ63 A2VEB + 2 x FXSQ80 A2VEB | 6 x FXSQ50 A2VEB + 10 x FXSQ63 A2VEB |

2 Specifications

2

| 2-3 Technical Specifications | | | | RXYQ22U | RXYQ24U | RXYQ26U | RXYQ28U | RXYQ30U | RXYQ32U | RXYQ34U | RXYQ36U | RXYQ38U |
|--|----------------------------|---------|-------|--|--|--|--|--|--|--|---|---|
| Recommended combination 3 | | | | 6 x FXMQ50 P7VEB + 4 x FXMQ63 P7VEB | 4 x FXMQ50 P7VEB + 4 x FXMQ63 P7VEB + 2 x FXMQ80 P7VEB | 7 x FXMQ50 P7VEB + 5 x FXMQ63 P7VEB | 6 x FXMQ50 P7VEB + 4 x FXMQ63 P7VEB + 2 x FXMQ80 P7VEB | 9 x FXMQ50 P7VEB + 5 x FXMQ63 P7VEB | 8 x FXMQ63 P7VEB + 4 x FXMQ80 P7VEB | 3 x FXMQ50 P7VEB + 9 x FXMQ63 P7VEB + 2 x FXMQ80 P7VEB | 2 x FXMQ50 P7VEB + 10 x FXMQ63 P7VEB + 2 x FXMQ80 P7VEB | 6 x FXMQ50 P7VEB + 10 x FXMQ63 P7VEB |
| Cooling capacity | Prated,c | | kW | 61.5 (1) | 67.4 (1) | 73.5 (1) | 78.5 (1) | 83.9 (1) | 90.0 (1) | 95.4 (1) | 97.0 (1) | 102.4 (1) |
| Heating capacity | Prated,h | | kW | 34.4 | 36.9 | 39.0 | 41.6 | 46.3 | 46.4 | 51.1 | 54.2 | 60.7 |
| | Max. | 6°CWB | kW | 69.0 (2) | 75.0 (2) | 82.5 (2) | 87.5 (2) | 94.0 (2) | 100.0 (2) | 106.5 (2) | 113.0 (2) | 119.5 (2) |
| SEER | | | | 6.9 | 6.8 | 6.7 | 6.5 | | 6.4 | | 6.3 | 6.9 |
| SEER recommended combination 2 | | | | 6.7 | 6.6 | 6.5 | 6.3 | | | | | 6.8 |
| SEER recommended combination 3 | | | | 6.9 | 6.7 | 6.6 | 6.4 | 6.5 | 6.2 | 6.3 | | 6.9 |
| SCOP | | | | 4.4 | 4.3 | 4.2 | | 4.3 | 4.2 | | 4.1 | 4.3 |
| SCOP recommended combination 2 | | | | 4.4 | 4.3 | 4.2 | | 4.3 | 4.2 | 4.3 | 4.2 | 4.3 |
| SCOP recommended combination 3 | | | | 4.3 | 4.2 | | | 4.3 | 4.1 | 4.2 | 4.1 | 4.2 |
| ηs,c | | | % | 274.5 | 269.9 | 264.2 | 257.8 | 256.8 | 251.7 | 253.3 | 250.8 | 272.4 |
| ηs,c recommended combination 2 | | | | 266.5 | 262.6 | 256.1 | 249.3 | 249.8 | 248.3 | 250.9 | 248.7 | 269.2 |
| ηs,c recommended combination 3 | | | | 273.3 | 265.3 | 261.1 | 253.1 | 256.1 | 244.2 | 249.8 | 247.2 | 272.2 |
| ηs,h | | | % | 171.2 | 167.0 | 164.6 | 166.0 | 169.8 | 163.1 | 166.2 | 162.4 | 167.5 |
| ηs,h recommended combination 2 | | | | 172.3 | 167.1 | 165.4 | 166.8 | 170.6 | 164.6 | 167.7 | 164.1 | 168.4 |
| ηs,h recommended combination 3 | | | | 170.2 | 165.5 | 164.5 | 165.0 | 167.0 | 161.9 | 164.2 | 159.9 | 164.8 |
| Capacity range | | | HP | 22 | 24 | 26 | 28 | 30 | 32 | 34 | 36 | 38 |
| Maximum number of connectable indoor units | | | | 64 (3) | | | | | | | | |
| Indoor index connection | Min. | | | 275.0 | 300.0 | 325.0 | 350.0 | 375.0 | 400.0 | 425.0 | 450.0 | 475.0 |
| | Max. | | | 715.0 | 780.0 | 845.0 | 910.0 | 975.0 | 1,040.0 | 1,105.0 | 1,170.0 | 1,235.0 |
| Heat exchanger | Indoor side | | | Air | | | | | | | | |
| | Outdoor side | | | Air | | | | | | | | |
| | Air flow rate | Cooling | Rated | m³/h | 21,600 | 25,320 | 24,480 | 26,700 | 26,160 | 31,200 | 30,660 | 31,260 |
| Heating | | Rated | m³/h | 21,600 | 25,320 | 24,480 | 26,700 | 26,160 | 31,200 | 30,660 | 31,260 | 35,880 |
| Sound power level | Cooling | Nom. | dBA | 84.8 (4) | 86.3 (4) | 85.3 (4) | 87.6 (4) | 86.6 (4) | 88.6 (4) | 87.8 (4) | 89.9 (4) | 88.8 (4) |
| | Heating | Nom. | dBA | 67.8 (4) | 69.6 (4) | 69.9 (4) | 70.1 (4) | 68.7 (4) | 71.6 (4) | 70.6 (4) | 70.9 (4) | 69.9 (4) |
| Sound pressure level | Cooling | Nom. | dBA | 62.5 (5) | 64.0 (5) | 63.5 (5) | 65.1 (5) | 64.5 (5) | 66.0 (5) | 65.5 (5) | 67.1 (5) | 66.2 (5) |
| Refrigerant | Type | | | R-410A | | | | | | | | |
| | GWP | | | 2,087.5 | | | | | | | | |
| Refrigerant oil | Type | | | Synthetic (ether) oil FVC68D | | | | | | | | |
| Piping connections | Liquid | Type | | Braze connection | | | | | | | | |
| | | OD | mm | 15.9 | | | 19.1 | | | | | |
| | Gas | Type | | Braze connection | | | | | | | | |
| | | OD | mm | 28.6 | 34.9 | | | | | 41.3 | | |
| Total piping length | System | Actual | m | 1,000 (6) | | | | | | | | |
| PED | Category | | | Category II | | | | | | | | |
| Space cooling | A Condition (35°C - 27/19) | EERd | | 2.6 | 2.5 | 2.6 | 2.3 | 2.1 | 2.3 | 2.1 | | 2.4 |
| | | Pdc | kW | 61.5 | 67.4 | 73.5 | 78.5 | 83.9 | 90.0 | 95.4 | 97.0 | 102.4 |
| | B Condition (30°C - 27/19) | EERd | | 4.8 | 4.6 | | 4.4 | 4.3 | | 4.2 | 4.1 | 4.5 |
| | | Pdc | kW | 45.3 | 49.7 | 54.2 | 57.8 | 61.8 | 66.3 | 70.3 | 71.5 | 75.5 |
| | C Condition (25°C - 27/19) | EERd | | 8.5 | 8.6 | 8.2 | 8.1 | 8.2 | 8.1 | | 7.9 | 8.5 |
| | | Pdc | kW | 29.1 | 31.9 | 34.8 | 37.2 | 39.7 | 42.6 | 45.2 | 45.9 | 48.5 |
| | D Condition (20°C - 27/19) | EERd | | 16.0 | 15.2 | 14.2 | 14.3 | 16.8 | 14.3 | 16.8 | 16.7 | 17.9 |
| | | Pdc | kW | 18.8 | 15.8 | 16.2 | 16.5 | 21.0 | 19.0 | 20.1 | 20.4 | 21.6 |
| Space cooling recommended combination 2 | A Condition (35°C - 27/19) | EERd | | 2.6 | 2.4 | 2.6 | 2.3 | 2.1 | 2.2 | 2.1 | | 2.3 |
| | | Pdc | kW | 61.5 | 67.4 | 73.5 | 78.5 | 83.9 | 90.0 | 95.4 | 97.0 | 102.4 |
| | B Condition (30°C - 27/19) | EERd | | 4.6 | 4.5 | 4.4 | 4.3 | 4.2 | | | 4.1 | 4.5 |
| | | Pdc | kW | 45.3 | 49.7 | 54.1 | 57.8 | 61.8 | 66.3 | 70.3 | 71.5 | 75.4 |
| | C Condition (25°C - 27/19) | EERd | | 8.2 | 8.4 | 7.9 | 7.8 | 7.9 | 8.0 | 8.1 | 7.9 | 8.4 |
| | | Pdc | kW | 29.1 | 31.9 | 34.8 | 37.2 | 39.7 | 42.6 | 45.2 | 45.9 | 48.5 |
| | D Condition (20°C - 27/19) | EERd | | 15.6 | 14.7 | 13.6 | 13.8 | 16.1 | 14.0 | 16.5 | | 17.8 |
| | | Pdc | kW | 18.4 | 15.4 | 15.7 | 16.5 | 20.5 | 18.9 | 20.1 | 20.4 | 21.6 |

8

2 Specifications

| 2-3 Technical Specifications | | | RXYQ22U | RXYQ24U | RXYQ26U | RXYQ28U | RXYQ30U | RXYQ32U | RXYQ34U | RXYQ36U | RXYQ38U | |
|---|--|-----------------------------------|----------------------------|---------|---------|---------|---------|---------|---------|---------|---------|-------|
| Space cooling recommended combination 3 | A Condition (35°C - 27/19) | EERd | 2.5 | | | 2.3 | 2.1 | 2.2 | 2.1 | | | 2.4 |
| | | Pdc | kW | 61.5 | 67.4 | 73.5 | 78.5 | 83.9 | 90.0 | 95.4 | 97.0 | 102.4 |
| | B Condition (30°C - 27/19) | EERd | 4.8 | 4.5 | | 4.3 | | 4.1 | | | 4.0 | 4.5 |
| | | Pdc | kW | 45.3 | 49.7 | 54.2 | 57.8 | 61.8 | 66.3 | 70.3 | 71.5 | 75.5 |
| | C Condition (25°C - 27/19) | EERd | 8.5 | 8.4 | 8.1 | 8.0 | 8.2 | 7.8 | 8.0 | 7.8 | 8.5 | 8.5 |
| | | Pdc | kW | 29.1 | 31.9 | 34.8 | 37.2 | 39.7 | 42.6 | 45.2 | 45.9 | 48.5 |
| | D Condition (20°C - 27/19) | EERd | 15.8 | 15.2 | 14.0 | 14.1 | 16.6 | 13.8 | 16.6 | 16.5 | 17.9 | 17.9 |
| | | Pdc | kW | 18.8 | 15.7 | 16.0 | 16.6 | 21.0 | 19.0 | 20.1 | 20.4 | 21.6 |
| Space heating (Average climate) | TBivalent | COPd (declared COP) | 2.3 | 2.5 | 2.3 | 2.2 | 2.1 | 2.4 | 2.2 | 2.1 | 2.2 | |
| | | Pdh (declared heating cap) | kW | 34.4 | 36.9 | 39.0 | 41.6 | 46.3 | 46.4 | 51.1 | 54.2 | 60.7 |
| | | Tbiv (bivalent temperature) | °C | -10 | | | | | | | | |
| | TOL | COPd (declared COP) | 2.3 | 2.5 | 2.3 | 2.2 | 2.1 | 2.4 | 2.2 | 2.1 | 2.2 | |
| | | Pdh (declared heating cap) | kW | 34.4 | 36.9 | 39.0 | 41.6 | 46.3 | 46.4 | 51.1 | 54.2 | 60.7 |
| | | Tol (temperature operating limit) | °C | -10 | | | | | | | | |
| | A Condition (-7°C) | COPd (declared COP) | 2.6 | 2.8 | 2.6 | | 2.7 | 2.6 | 2.5 | | | |
| | | Pdh (declared heating cap) | kW | 30.4 | 32.6 | 34.5 | 36.8 | 41.0 | | 45.2 | 47.9 | 53.7 |
| | B Condition (2°C) | COPd (declared COP) | 4.0 | 3.7 | 3.8 | | 3.9 | 3.6 | 3.7 | | | |
| | | Pdh (declared heating cap) | kW | 18.5 | 19.9 | 21.0 | 22.4 | 24.9 | 25.0 | 27.5 | 29.2 | 32.7 |
| | C Condition (7°C) | COPd (declared COP) | 6.3 | | 6.1 | 6.2 | 6.5 | 6.3 | 6.5 | 6.4 | 6.5 | |
| | | Pdh (declared heating cap) | kW | 11.9 | 13.0 | 13.5 | 14.4 | 16.0 | 16.1 | 17.7 | 18.8 | 21.3 |
| | D Condition (12°C) | COPd (declared COP) | 8.2 | 8.9 | 8.8 | 9.0 | | | 8.8 | 8.6 | 8.7 | |
| | | Pdh (declared heating cap) | kW | 6.0 | 5.7 | 6.0 | 6.4 | 7.1 | | 7.9 | 8.3 | 13.1 |
| | Space heating (Average climate) recommended combination 2 | A Condition (-7°C) | COPd (declared COP) | 2.6 | 2.7 | 2.6 | | 2.7 | 2.6 | 2.5 | | |
| | | | Pdh (declared heating cap) | kW | 30.4 | 32.6 | 34.5 | 36.8 | 41.0 | | 45.2 | 47.9 |
| | | B Condition (2°C) | COPd (declared COP) | 4.1 | 3.7 | 3.8 | | 3.9 | 3.6 | 3.8 | 3.7 | 3.9 |
| | | | Pdh (declared heating cap) | kW | 18.5 | 19.9 | 21.0 | 22.4 | 24.9 | 25.0 | 27.5 | 29.2 |
| C Condition (7°C) | | COPd (declared COP) | 6.3 | | 6.1 | 6.3 | 6.6 | 6.3 | 6.6 | 6.5 | | |
| | | Pdh (declared heating cap) | kW | 11.9 | 13.1 | | 14.4 | 16.0 | 16.1 | 17.7 | 18.8 | 21.3 |
| D Condition (12°C) | | COPd (declared COP) | 8.4 | 9.0 | 8.9 | 9.1 | | | 8.9 | 8.8 | | |
| | | Pdh (declared heating cap) | kW | 6.0 | 5.7 | 6.0 | 6.4 | 7.2 | 7.1 | 7.9 | 8.3 | 13.2 |
| TBivalent | | COPd (declared COP) | 2.2 | 2.4 | 2.2 | | 2.1 | 2.4 | 2.2 | | | |
| | | Pdh (declared heating cap) | kW | 34.4 | 36.9 | 39.0 | 41.6 | 46.3 | 46.4 | 51.1 | 54.2 | 60.7 |
| | | Tbiv (bivalent temperature) | °C | -10 | | | | | | | | |
| TOL | | COPd (declared COP) | 2.2 | 2.4 | 2.2 | | 2.1 | 2.4 | 2.2 | | | |
| | | Pdh (declared heating cap) | kW | 34.4 | 36.9 | 39.0 | 41.6 | 46.3 | 46.4 | 51.1 | 54.2 | 60.7 |
| | | Tol (temperature operating limit) | °C | -10 | | | | | | | | |

2 Specifications

2

| 2-3 Technical Specifications | | | | | RXYQ22U | RXYQ24U | RXYQ26U | RXYQ28U | RXYQ30U | RXYQ32U | RXYQ34U | RXYQ36U | RXYQ38U |
|--|---------------------------|-----------------------------|------|------|---------|---------|---------|---------|---------|---------|---------|---------|---------|
| Space heating (Average climate) recommended combination 3 | A Condition (-7°C) | COPd (declared COP) | | | 2.6 | 2.7 | 2.6 | | 2.5 | 2.7 | 2.6 | 2.4 | 2.5 |
| | | Pdh (declared heating cap) | kW | | 30.4 | 32.6 | 34.5 | 36.8 | 41.0 | | 45.2 | 47.9 | 53.7 |
| | B Condition (2°C) | COPd (declared COP) | | | 4.0 | 3.7 | 3.8 | | 3.9 | 3.6 | 3.7 | 3.6 | 3.8 |
| | | Pdh (declared heating cap) | kW | | 18.5 | 19.9 | 21.0 | 22.4 | 24.9 | 25.0 | 27.5 | 29.2 | 32.7 |
| | C Condition (7°C) | COPd (declared COP) | | | 6.2 | 6.3 | 6.1 | 6.2 | 6.3 | | 6.4 | 6.3 | |
| | | Pdh (declared heating cap) | kW | | 11.9 | 12.9 | 13.5 | 14.4 | 16.0 | 16.1 | 17.7 | 18.8 | 21.2 |
| | D Condition (12°C) | COPd (declared COP) | | | 8.2 | 8.9 | 8.8 | 9.0 | 8.6 | 9.0 | 8.9 | 8.3 | 8.5 |
| | | Pdh (declared heating cap) | kW | | 6.0 | 5.7 | 6.0 | 6.4 | 7.1 | | 7.9 | 8.3 | 12.9 |
| | TBivalent | COPd (declared COP) | | | 2.3 | 2.4 | 2.2 | | 2.1 | 2.4 | 2.2 | 2.1 | 2.2 |
| | | Pdh (declared heating cap) | kW | | 34.4 | 36.9 | 39.0 | 41.6 | 46.3 | 46.4 | 51.1 | 54.2 | 60.7 |
| | | Tbiv (bivalent temperature) | °C | | -10 | | | | | | | | |
| | TOL | COPd (declared COP) | | | 2.3 | 2.4 | 2.2 | | 2.1 | 2.4 | 2.2 | 2.1 | 2.2 |
| Pdh (declared heating cap) | | kW | | 34.4 | 36.9 | 39.0 | 41.6 | 46.3 | 46.4 | 51.1 | 54.2 | 60.7 | |
| Tol (temperature operating limit) | | °C | | -10 | | | | | | | | | |
| Cooling | Cdc (Degradation cooling) | | | 0.25 | | | | | | | | | |
| Heating | Cdh (Degradation heating) | | | 0.25 | | | | | | | | | |
| Power consumption in other than active mode | Off mode | Cooling | POFF | kW | 0.081 | 0.115 | | 0.116 | 0.149 | 0.150 | 0.157 | | |
| | | Heating | POFF | kW | 0.103 | 0.129 | | 0.141 | 0.154 | 0.166 | 0.192 | | |
| | Standby mode | Cooling | PSB | kW | 0.081 | 0.115 | | 0.116 | 0.149 | 0.150 | 0.157 | | |
| | | Heating | PSB | kW | 0.103 | 0.129 | | 0.141 | 0.154 | 0.166 | 0.192 | | |
| | Thermostat-off mode | Cooling | PTO | kW | 0.009 | 0.014 | | | 0.019 | | | | |
| | | Heating | PTO | kW | 0.113 | 0.154 | | 0.155 | 0.195 | 0.196 | 0.211 | | |
| Indication if the heater is equipped with a supplementary heater | | | | no | | | | | | | | | |
| Supplementary heater | Back-up capacity | Heating | elbu | kW | 0.0 | | | | | | | | |

Standard Accessories : Installation manual; Quantity : 1;

Standard Accessories : Operation manual; Quantity : 1;

Standard Accessories : Connection pipes; Quantity : 1;

| 2-4 Technical Specifications | | | | RXYQ40U | RXYQ42U | RXYQ44U | RXYQ46U | RXYQ48U | RXYQ50U | RXYQ52U | RXYQ54U | |
|------------------------------|-----------------------|--|--|--|---|--|---|---|---|---|---|--|
| System | Outdoor unit module 1 | | | RXYQ10U | | RXYQ12U | RXYQ14U | RXYQ16U | | | RXYQ18U | |
| | Outdoor unit module 2 | | | RXYQ12U | RXYQ16U | | | | | | RXYQ18U | |
| | Outdoor unit module 3 | | | RXYQ18U | RXYQ16U | | | | | RXYQ18U | | |
| Recommended combination | | | | 9 x FXFQ50A VEB + 9 x FXFQ63A VEB | 12 x FXFQ63A VEB + 4 x FXFQ80A VEB | 6 x FXFQ50A VEB + 8 x FXFQ63A VEB + 4 x FXFQ80A VEB | 1 x FXFQ50A VEB + 13 x FXFQ63A VEB + 4 x FXFQ80A VEB | 12 x FXFQ63A VEB + 6 x FXFQ80A VEB | 3 x FXFQ50A VEB + 13 x FXFQ63A VEB + 4 x FXFQ80A VEB | 6 x FXFQ50A VEB + 14 x FXFQ63A VEB + 2 x FXFQ80A VEB | 9 x FXFQ50A VEB + 15 x FXFQ63A VEB | |
| Recommended combination 2 | | | | 9 x FXSQ50A 2VEB + 9 x FXSQ63A 2VEB | 12 x FXSQ63A 2VEB + 4 x FXSQ80A 2VEB | 6 x FXSQ50A 2VEB + 8 x FXSQ63A 2VEB + 4 x FXSQ80A 2VEB | 1 x FXSQ50A 2VEB + 13 x FXSQ63A 2VEB + 4 x FXSQ80A 2VEB | 12 x FXSQ63A 2VEB + 6 x FXSQ80A 2VEB | 3 x FXSQ50A 2VEB + 13 x FXSQ63A 2VEB + 4 x FXSQ80A 2VEB | 6 x FXSQ50A 2VEB + 14 x FXSQ63A 2VEB + 2 x FXSQ80A 2VEB | 9 x FXSQ50A 2VEB + 15 x FXSQ63A 2VEB | |

2 Specifications

| 2-4 Technical Specifications | | | | RXYQ40U | RXYQ42U | RXYQ44U | RXYQ46U | RXYQ48U | RXYQ50U | RXYQ52U | RXYQ54U | |
|--|----------------------------|---------|-------|--|---|--|---|---|---|---|---|--------|
| Recommended combination 3 | | | | 9 x FXMQ50P 7VEB + 9 x FXMQ63P 7VEB | 12 x FXMQ63P 7VEB + 4 x FXMQ80P 7VEB | 6 x FXMQ50P 7VEB + 8 x FXMQ63P 7VEB + 4 x FXMQ80P 7VEB | 1 x FXMQ50P 7VEB + 13 x FXMQ63P 7VEB + 4 x FXMQ80P 7VEB | 12 x FXMQ63P 7VEB + 6 x FXMQ80P 7VEB | 3 x FXMQ50P 7VEB + 13 x FXMQ63P 7VEB + 4 x FXMQ80P 7VEB | 6 x FXMQ50P 7VEB + 14 x FXMQ63P 7VEB + 2 x FXMQ80P 7VEB | 9 x FXMQ50P 7VEB + 15 x FXMQ63P 7VEB | |
| Cooling capacity | Prated,c | | kW | 111.9 (1) | 118.0 (1) | 123.5 (1) | 130.0 (1) | 135.0 (1) | 140.4 (1) | 145.8 (1) | 151.2 (1) | |
| Heating capacity | Prated,h | | kW | 62.3 | 62.4 | 64.8 | 67.0 | 69.6 | 74.3 | 79.0 | 83.7 | |
| | Max. | 6°CWB | kW | 125.5 (2) | 131.5 (2) | 137.5 (2) | 145.0 (2) | 150.0 (2) | 156.5 (2) | 163.0 (2) | 169.5 (2) | |
| SEER | | | | 6.7 | 6.6 | 6.5 | 6.4 | | | | | |
| SEER recommended combination 2 | | | | 6.6 | | 6.3 | 6.4 | 6.3 | | 6.4 | | |
| SEER recommended combination 3 | | | | 6.7 | 6.5 | 6.3 | | 6.2 | 6.3 | 6.4 | | |
| SCOP | | | | 4.3 | 4.2 | | 4.1 | | 4.2 | 4.3 | | |
| SCOP recommended combination 2 | | | | 4.4 | 4.3 | 4.2 | | | | | 4.3 | |
| SCOP recommended combination 3 | | | | 4.3 | 4.2 | | 4.1 | | 4.2 | | | |
| ηs,c | | | % | 263.5 | 261.2 | 255.9 | 254.9 | 251.7 | 252.8 | 253.7 | 254.1 | |
| ηs,c recommended combination 2 | | | | 259.2 | 259.3 | 249.2 | 252.2 | 248.3 | 250.0 | 251.6 | 252.5 | |
| ηs,c recommended combination 3 | | | | 263.2 | 255.4 | 250.1 | 248.3 | 244.2 | 248.0 | 251.5 | 253.9 | |
| ηs,h | | | % | 170.0 | 165.5 | 164.5 | 162.0 | 162.8 | 165.2 | 167.2 | 169.4 | |
| ηs,h recommended combination 2 | | | | 171.3 | 167.3 | 165.6 | 163.5 | 164.3 | 166.7 | 168.7 | 170.8 | |
| ηs,h recommended combination 3 | | | | 167.8 | 164.4 | 163.5 | 161.3 | 161.7 | 163.2 | 164.4 | 166.0 | |
| Capacity range | | | HP | 40 | 42 | 44 | 46 | 48 | 50 | 52 | 54 | |
| Maximum number of connectable indoor units | | | | 64 (3) | | | | | | | | |
| Indoor index connection | Min. | | | 500.0 | 525.0 | 550.0 | 575.0 | 600.0 | 625.0 | 650.0 | 675.0 | |
| | Max. | | | 1,300.0 | 1,365.0 | 1,430.0 | 1,495.0 | 1,560.0 | 1,625.0 | 1,690.0 | 1,755.0 | |
| Heat exchanger | Indoor side | | | Air | | | | | | | | |
| | Outdoor side | | | Air | | | | | | | | |
| | Air flow rate | Cooling | Rated | m³/h | 36,660 | 41,700 | 42,300 | 44,580 | 46,800 | 46,260 | 45,720 | 45,180 |
| | | Heating | Rated | m³/h | 36,660 | 41,700 | 42,300 | 44,580 | 46,800 | 46,260 | 45,720 | 45,180 |
| Sound power level | Cooling | Nom. | dBA | 87.3 (4) | 89.1 (4) | 89.8 (4) | 89.3 (4) | 90.4 (4) | 89.8 (4) | 89.3 (4) | 88.6 (4) | |
| | Heating | Nom. | dBA | 70.2 (4) | 72.4 (4) | | 73.3 (4) | 73.4 (4) | 72.7 (4) | 72.0 (4) | 71.1 (4) | |
| Sound pressure level | Cooling | Nom. | dBA | 65.2 (5) | 66.5 (5) | 67.2 (5) | 67.0 (5) | 67.8 (5) | 67.5 (5) | 67.1 (5) | 66.8 (5) | |
| Refrigerant | Type | | | R-410A | | | | | | | | |
| | GWP | | | 2,087.5 | | | | | | | | |
| Refrigerant oil | Type | | | Synthetic (ether) oil FVC68D | | | | | | | | |
| Piping connections | Liquid | Type | | Braze connection | | | | | | | | |
| | | OD | mm | 19.1 | | | | | | | | |
| | Gas | Type | | Braze connection | | | | | | | | |
| | | OD | mm | 41.3 | | | | | | | | |
| Total piping length | System | Actual | m | 1,000 (6) | | | | | | | | |
| PED | Category | | | Category II | | | | | | | | |
| Space cooling | A Condition (35°C - 27/19) | EERd | | 2.2 | 2.3 | | 2.4 | 2.3 | 2.1 | 2.0 | 1.9 | |
| | | Pdc | kW | 111.9 | 118.0 | 123.5 | 130.0 | 135.0 | 140.4 | 145.8 | 151.2 | |
| | B Condition (30°C - 27/19) | EERd | | 4.5 | 4.4 | | | 4.3 | 4.2 | | 4.1 | |
| | | Pdc | kW | 82.5 | 86.9 | 91.0 | 95.8 | 99.5 | 103.4 | 107.4 | 111.4 | |
| | C Condition (25°C - 27/19) | EERd | | 8.3 | 8.2 | 8.1 | | | | | | |
| | | Pdc | kW | 53.0 | 55.9 | 58.5 | 61.6 | 64.0 | 66.5 | 69.1 | 71.6 | |
| | D Condition (20°C - 27/19) | EERd | | 16.0 | 15.4 | 14.4 | 14.3 | | 15.9 | 17.6 | 19.1 | |
| | | Pdc | kW | 23.6 | 24.8 | 26.0 | 27.4 | 28.4 | 29.6 | 30.7 | 34.4 | |
| Space cooling recommended combination 2 | A Condition (35°C - 27/19) | EERd | | 2.2 | 2.3 | | 2.2 | 2.1 | 2.0 | 1.9 | | |
| | | Pdc | kW | 111.9 | 118.0 | 123.5 | 130.0 | 135.0 | 140.4 | 145.8 | 151.2 | |
| | B Condition (30°C - 27/19) | EERd | | 4.4 | | 4.3 | | 4.2 | | 4.1 | | |
| | | Pdc | kW | 82.4 | 86.9 | 91.0 | 95.8 | 99.5 | 103.5 | 107.4 | 111.4 | |
| | C Condition (25°C - 27/19) | EERd | | 8.1 | 8.2 | 7.9 | 8.1 | 8.0 | | | 8.1 | |
| | | Pdc | kW | 53.0 | 55.9 | 58.5 | 61.6 | 63.9 | 66.5 | 69.0 | 71.6 | |
| | D Condition (20°C - 27/19) | EERd | | 15.9 | 15.3 | 14.0 | | | 15.6 | 17.4 | 18.9 | |
| | | Pdc | kW | 23.6 | 24.8 | 26.0 | 27.4 | 28.4 | 29.6 | 30.7 | 34.1 | |

2 Specifications

2

| 2-4 Technical Specifications | | | RXYQ40U | RXYQ42U | RXYQ44U | RXYQ46U | RXYQ48U | RXYQ50U | RXYQ52U | RXYQ54U | | |
|---|--|-----------------------------------|----------------------------|---------|---------|---------|---------|---------|---------|---------|------|-----|
| Space cooling recommended combination 3 | A Condition (35°C - 27/19) | EERd | 2.2 | 2.3 | | | 2.2 | 2.1 | 2.0 | 1.9 | | |
| | | Pdc | 111.9 | 118.0 | 123.5 | 130.0 | 135.0 | 140.4 | 145.8 | 151.2 | | |
| | B Condition (30°C - 27/19) | EERd | 4.4 | 4.3 | | | 4.2 | 4.1 | | | | |
| | | Pdc | 82.5 | 87.0 | 91.0 | 95.8 | 99.5 | 103.5 | 107.4 | 111.4 | | |
| | C Condition (25°C - 27/19) | EERd | 8.4 | 8.0 | 7.9 | | | 7.8 | 7.9 | 8.0 | 8.2 | |
| | | Pdc | 53.0 | 55.9 | 58.5 | 61.6 | 63.9 | 66.5 | 69.1 | 71.6 | | |
| | D Condition (20°C - 27/19) | EERd | 16.1 | 15.2 | 14.2 | 13.9 | 13.8 | 15.6 | 17.5 | 19.1 | | |
| | | Pdc | 23.6 | 24.8 | 26.0 | 27.4 | 28.4 | 29.6 | 30.7 | 34.7 | | |
| Space heating (Average climate) | TBivalent | COPd (declared COP) | 2.2 | 2.4 | 2.3 | 2.4 | | 2.3 | 2.2 | 2.1 | | |
| | | Pdh (declared heating cap) | 62.3 | 62.4 | 64.8 | 67.0 | 69.6 | 74.3 | 79.0 | 83.7 | | |
| | | Tbiv (bivalent temperature) | °C | -10 | | | | | | | | |
| | TOL | COPd (declared COP) | 2.2 | 2.4 | 2.3 | 2.4 | | 2.3 | 2.2 | 2.1 | | |
| | | Pdh (declared heating cap) | 62.3 | 62.4 | 64.8 | 67.0 | 69.6 | 74.3 | 79.0 | 83.7 | | |
| | | Tol (temperature operating limit) | °C | -10 | | | | | | | | |
| | A Condition (-7°C) | COPd (declared COP) | 2.6 | 2.7 | | | | | 2.6 | | | |
| | | Pdh (declared heating cap) | 55.1 | 55.2 | 57.3 | 59.3 | 61.6 | 65.7 | 69.9 | 74.0 | | |
| | B Condition (2°C) | COPd (declared COP) | 4.0 | 3.7 | | | 3.6 | | 3.7 | 3.8 | 3.9 | |
| | | Pdh (declared heating cap) | 33.5 | 33.6 | 34.9 | 36.1 | 37.5 | 40.0 | 42.5 | 45.1 | | |
| | C Condition (7°C) | COPd (declared COP) | 6.5 | 6.3 | | | 6.2 | 6.3 | 6.5 | 6.6 | 6.8 | |
| | | Pdh (declared heating cap) | 21.6 | | 22.4 | 23.2 | 24.1 | 25.7 | 27.4 | 29.0 | | |
| | D Condition (12°C) | COPd (declared COP) | 8.7 | 8.6 | | | 8.7 | 8.8 | 8.9 | 9.0 | | |
| | | Pdh (declared heating cap) | 13.1 | 9.9 | 10.0 | 10.3 | 10.7 | 12.0 | 14.2 | | | |
| | Space heating (Average climate) recommended combination 2 | A Condition (-7°C) | COPd (declared COP) | 2.6 | 2.7 | | | | | 2.6 | | |
| | | | Pdh (declared heating cap) | 55.1 | 55.2 | 57.3 | 59.3 | 61.6 | 65.7 | 69.9 | 74.0 | |
| | | B Condition (2°C) | COPd (declared COP) | 4.0 | 3.7 | | | 3.6 | | 3.7 | 3.8 | 3.9 |
| | | | Pdh (declared heating cap) | 33.5 | 33.6 | 34.9 | 36.1 | 37.5 | 40.0 | 42.6 | 45.1 | |
| C Condition (7°C) | | COPd (declared COP) | 6.5 | 6.4 | 6.3 | | | 6.5 | 6.7 | 6.8 | | |
| | | Pdh (declared heating cap) | 21.6 | | 22.4 | 22.8 | 24.1 | 25.7 | 27.4 | 29.0 | | |
| D Condition (12°C) | | COPd (declared COP) | 8.8 | 8.7 | | | 8.8 | 8.9 | 9.0 | 9.1 | | |
| | | Pdh (declared heating cap) | 13.2 | 10.0 | | | 10.3 | 10.7 | 12.2 | 14.4 | | |
| TBivalent | | COPd (declared COP) | 2.2 | 2.4 | 2.3 | 2.4 | | 2.3 | 2.2 | 2.1 | | |
| | | Pdh (declared heating cap) | 62.3 | 62.4 | 64.8 | 67.0 | 69.6 | 74.3 | 79.0 | 83.7 | | |
| | | Tbiv (bivalent temperature) | °C | -10 | | | | | | | | |
| TOL | | COPd (declared COP) | 2.2 | 2.4 | 2.3 | 2.4 | | 2.3 | 2.2 | 2.1 | | |
| | | Pdh (declared heating cap) | 62.3 | 62.4 | 64.8 | 67.0 | 69.6 | 74.3 | 79.0 | 83.7 | | |
| | | Tol (temperature operating limit) | °C | -10 | | | | | | | | |

2 Specifications

| 2-4 Technical Specifications | | | | | RXYQ40U | RXYQ42U | RXYQ44U | RXYQ46U | RXYQ48U | RXYQ50U | RXYQ52U | RXYQ54U |
|--|---------------------------|-----------------------------|------|------|---------|---------|---------|---------|---------|---------|---------|---------|
| Space heating (Average climate) recommended combination 3 | A Condition (-7°C) | COPd (declared COP) | | | 2.6 | 2.7 | 2.6 | 2.7 | | 2.6 | | 2.5 |
| | | Pdh (declared heating cap) | kW | | 55.1 | 55.2 | 57.3 | 59.3 | 61.6 | 65.7 | 69.9 | 74.0 |
| | B Condition (2°C) | COPd (declared COP) | | | 3.9 | 3.7 | | 3.6 | | 3.7 | | 3.8 |
| | | Pdh (declared heating cap) | kW | | 33.5 | 33.6 | 34.9 | 36.1 | 37.5 | 40.0 | 42.5 | 45.1 |
| | C Condition (7°C) | COPd (declared COP) | | | 6.4 | 6.3 | 6.2 | | 6.3 | 6.4 | | 6.5 |
| | | Pdh (declared heating cap) | kW | | 21.6 | | 22.4 | 23.2 | 24.1 | 25.7 | 27.3 | 29.0 |
| | D Condition (12°C) | COPd (declared COP) | | | 8.4 | 8.6 | | 8.7 | 8.8 | 8.7 | | |
| | | Pdh (declared heating cap) | kW | | 12.8 | 9.9 | 10.0 | 10.3 | 10.7 | 11.8 | 13.7 | |
| | TBivalent | COPd (declared COP) | | | 2.2 | 2.4 | 2.3 | 2.4 | | 2.2 | | 2.1 |
| | | Pdh (declared heating cap) | kW | | 62.3 | 62.4 | 64.8 | 67.0 | 69.6 | 74.3 | 79.0 | 83.7 |
| | | Tbiv (bivalent temperature) | °C | | -10 | | | | | | | |
| | TOL | COPd (declared COP) | | | 2.2 | 2.4 | 2.3 | 2.4 | | 2.2 | | 2.1 |
| Pdh (declared heating cap) | | kW | | 62.3 | 62.4 | 64.8 | 67.0 | 69.6 | 74.3 | 79.0 | 83.7 | |
| Tol (temperature operating limit) | | °C | | -10 | | | | | | | | |
| Cooling | Cdc (Degradation cooling) | | | 0.25 | | | | | | | | |
| Heating | Cdh (Degradation heating) | | | 0.25 | | | | | | | | |
| Power consumption in other than active mode | Off mode | Cooling | POFF | kW | 0.157 | 0.190 | | 0.223 | | 0.224 | 0.225 | 0.226 |
| | | Heating | POFF | kW | 0.192 | 0.206 | | 0.231 | | 0.243 | 0.255 | 0.267 |
| | Standby mode | Cooling | PSB | kW | 0.157 | 0.190 | | 0.223 | | 0.224 | 0.225 | 0.226 |
| | | Heating | PSB | kW | 0.192 | 0.206 | | 0.231 | | 0.243 | 0.255 | 0.267 |
| | Thermostat-off mode | Cooling | PTO | kW | 0.019 | 0.024 | | 0.029 | | | | |
| | | Heating | PTO | kW | 0.211 | 0.251 | | 0.292 | | 0.293 | 0.294 | |
| Indication if the heater is equipped with a supplementary heater | | | | no | | | | | | | | |
| Supplementary heater | Back-up capacity | Heating | elbu | kW | 0.0 | | | | | | | |

Standard Accessories : Installation manual; Quantity : 1;

Standard Accessories : Operation manual; Quantity : 1;

Standard Accessories : Connection pipes; Quantity : 1;

| 2-5 Electrical Specifications | | | | | RXYQ22U | RXYQ24U | RXYQ26U | RXYQ28U | RXYQ30U | RXYQ32U | RXYQ34U | RXYQ36U | RXYQ38U | |
|-------------------------------|--------------------------------------|----------|---|------------------------------|-----------------|----------|----------|----------|----------|----------|----------|----------|----------|--|
| Power supply | Name | | | Y1 | | | | | | | | | | |
| | Phase | | | 3N~ | | | | | | | | | | |
| | Frequency | | | 50 | | | | | | | | | | |
| | Voltage | | | 380-415 | | | | | | | | | | |
| Voltage range | Min. | | | -10 | | | | | | | | | | |
| | Max. | | | 10 | | | | | | | | | | |
| Current | Nominal running current (RLA) - 50Hz | Cooling | A | 22.9 (7) | 25.2 (7) | 28.1 (7) | 30.7 (7) | 33.5 (7) | 36.0 (7) | 38.8 (7) | 44.9 (7) | 44.3 (7) | | |
| Current - 50Hz | Starting current (MSC) - remark | | | (8) | | | | | | | | | | |
| | Zmax | List | | | No requirements | | | | | | | | | |
| | Minimum circuit amps (MCA) | | | A | 46.0 (9) | 51.0 (9) | 55.0 (9) | 59.0 (9) | 62.0 (9) | 66.0 (9) | 70.0 (9) | 76.0 (9) | | |
| | Maximum fuse amps (MFA) | | | A | 63 (10) | | | | 80 (10) | | | | 100 (10) | |
| Wiring connections - 50Hz | For power supply | Quantity | | | 5G | | | | | | | | | |
| | For connection with indoor | Quantity | | | 2 | | | | | | | | | |
| | Remark | | | F1,F2 | | | | | | | | | | |
| Power supply intake | | | | Both indoor and outdoor unit | | | | | | | | | | |

| 2-6 Electrical Specifications | | | | | RXYQ40U | RXYQ42U | RXYQ44U | RXYQ46U | RXYQ48U | RXYQ50U | RXYQ52U | RXYQ54U |
|-------------------------------|-----------|--|--|---------|---------|---------|---------|---------|---------|---------|---------|---------|
| Power supply | Name | | | Y1 | | | | | | | | |
| | Phase | | | 3N~ | | | | | | | | |
| | Frequency | | | 50 | | | | | | | | |
| | Voltage | | | 380-415 | | | | | | | | |

2 Specifications

| 2-6 Electrical Specifications | | | | RXYQ40U | RXYQ42U | RXYQ44U | RXYQ46U | RXYQ48U | RXYQ50U | RXYQ52U | RXYQ54U |
|-------------------------------|--------------------------------------|----------|---|------------------------------|----------|----------|----------|----------|----------|-----------|-----------|
| Voltage range | Min. | % | | -10 | | | | | | | |
| | Max. | % | | 10 | | | | | | | |
| Current | Nominal running current (RLA) - 50Hz | Cooling | A | 43.7 (7) | 46.2 (7) | 48.7 (7) | 51.4 (7) | 54.0 (7) | 56.8 (7) | 59.6 (7) | 62.4 (7) |
| Current - 50Hz | Starting current (MSC) - remark | | | (8) | | | | | | | |
| | Zmax | List | | No requirements | | | | | | | |
| | Minimum circuit amps (MCA) | | A | 81.0 (9) | 84.0 (9) | 86.0 (9) | 89.0 (9) | 93.0 (9) | 97.0 (9) | 101.0 (9) | 105.0 (9) |
| | Maximum fuse amps (MFA) | | A | 100 (10) | | | | 125 (10) | | | |
| Wiring connections - 50Hz | For power supply | Quantity | | 5G | | | | | | | |
| | For connection with indoor | Quantity | | 2 | | | | | | | |
| | | Remark | | F1,F2 | | | | | | | |
| Power supply intake | | | | Both indoor and outdoor unit | | | | | | | |

Notes

- (1) Cooling: indoor temp. 27°CDB, 19°CWB; outdoor temp. 35°CDB; equivalent piping length: 7.5m; level difference: 0m
 - (2) Heating: indoor temp. 20°CDB; outdoor temp. 7°CDB, 6°CWB; equivalent refrigerant piping: 7.5m; level difference: 0m
 - (3) Actual number of connectable indoor units depends on the indoor unit type (VRV indoor, Hydrobox, RA indoor, etc.) and the connection ratio restriction for the system (50% ≤ CR ≤ 130%)
 - (4) Sound power level is an absolute value that a sound source generates.
 - (5) Sound pressure level is a relative value, depending on the distance and acoustic environment. For more details, please refer to the sound level drawings.
 - (6) Refer to refrigerant pipe selection or installation manual
 - (7) RLA is based on following conditions: indoor temp. 27°CDB, 19°CWB; outdoor temp. 35°CDB
 - (8) MSC means the maximum current during start up of the compressor. VRV IV uses only inverter compressors. Starting current is always ≤ max. running current.
 - (9) MCA must be used to select the correct field wiring size. The MCA can be regarded as the maximum running current.
 - (10) MFA is used to select the circuit breaker and the ground fault circuit interrupter (earth leakage circuit breaker).
- In accordance with EN/IEC 61000-3-12, it may be necessary to consult the distribution network operator to ensure that the equipment is connected only to a supply with Ssc ≥ minimum Ssc value
- FLA means the nominal running current of the fan
- Maximum allowable voltage range variation between phases is 2%.
- Voltage range: units are suitable for use on electrical systems where voltage supplied to unit terminal is not below or above listed range limits.
- The AUTOMATIC ESEER value corresponds with normal VRV4 Heat Pump operation, taking into account advanced energy saving operation functionality (variable refrigerant temperature)
- The STANDARD ESEER value corresponds with normal VRV4 Heat Pump operation, not taking into account advanced energy saving operation functionality
- Sound values are measured in a semi-anechoic room.
- Soundpressure system [dBA] = 10*log[10^(A/10)+10^(B/10)+10^(C/10)] , with Unit A = A dBA, Unit B = B dBA, Unit C = C dBA
- EN/IEC 61000-3-12: European/international technical standard setting the limits for harmonic currents produced by equipment connected to public low-voltage system with input current > 16A and ≤ 75A per phase
- Ssc: Short-circuit power
- For detailed contents of standard accessories, see installation/operation manual
- Multi combination (22~54HP) data is corresponding with the standard multi combination

3 Options

3 - 1 Options

RXYQQ-U
RXYQ-U
RYYQ-U
RYMQ-U

| No | Item | RXYQ8U RYYQ8U RXYQQ8U | | RXYQ10-12U RYYQ10-12U RXYQQ10-12U | | RXYQ14-18U RYYQ14-18U RXYQQ14-18U | | RXYQ20U RYYQ20U RXYQQ20U | | RYYQ22~54U RXYQ22~54U RXYQQ22~42U | |
|------|---------------------------------|-----------------------------|------|---|------------|---|------|--------------------------------|-----|---|--|
| | | | | | | | | | | | |
| I. | Refnet header | KHRQ22M29H | | | | | | | | | |
| | | KHRQ22M64H | | | | | | | | | |
| | | --- | --- | --- | KHRQ22M75H | | | | | | |
| II. | Refnet joint | KHRQ22M20T | | | | | | | | | |
| | | KHRQ22M29T9 | | | | | | | | | |
| | | KHRQ22M64T | | | | | | | | | |
| | | --- | --- | --- | KHRQ22M75T | | | | | | |
| III. | Outdoor multi-connection kit | See note 2. | --- | --- | --- | --- | --- | --- | --- | BHFQ22P1007 | |
| IV. | Outdoor multi-connection kit | See note 2. | --- | --- | --- | --- | --- | --- | --- | BHFQ22P1517 | |
| No | Item | 8HP | 10HP | 12HP | 14HP | 16HP | 18HP | 20HP | | | |
| 1a | Cool/heat selector (switch) | See note 4. | | KRC19-26A | | | | | | | |
| 1b | Cool/heat selector (PCB) | BRP2A81 | | | | | | | | | |
| 1c | Cool/heat selector (fixing box) | KJB111A | | | | | | | | | |
| 2 | VRV configurator | EKPCAB* | | | | | | | | | |
| 3 | Heater tape kit PCB | EKBPH012T7A | | | | EKBPH020T7A | | | | | |
| 4 | Demand PCB | See note 5. | | DTA104A61/62* | | | | | | | |
| 5 | Demand PCB mounting plate | See note 5. | | --- | | | | KKS26B1* | | | |

Notes

- 1 All options are kits
- 2 Only for multi units
- 3 To operate the cool/heat selector function, options 1a and 1b are both required.
- 4 To mount option 1a, option 1c is required.
- 5 To install the demand PCB on the large casing type, the demand PCB mounting plate is required.

Medium casing type VRV4 heat pump: modules 8~12HP
Large casing type VRV4 heat pump: modules 14~20HP

3D120006

4 Combination table

4 - 1 Combination Table

RXYQQ-U
RXYQ-U
RYYQ-U
RYMQ-U

Heat pump VRV4
Multi-unit standard combinations table

| | | 8HP | 10HP | 12HP | 14HP | 16HP | 18HP | 20HP |
|--|-----------------------------|-----|------|------|------|------|------|------|
| Heat pump | RXYQ8* / RYYQ8* / RXYQ08* | 1 | | | | | | |
| | RXYQ10* / RYYQ10* / RXYQ10* | | 1 | | | | | |
| | RXYQ12* / RYYQ12* / RXYQ12* | | | 1 | | | | |
| | RXYQ14* / RYYQ14* / RXYQ14* | | | | 1 | | | |
| | RXYQ16* / RYYQ16* / RXYQ16* | | | | | 1 | | |
| | RXYQ18* / RYYQ18* / RXYQ18* | | | | | | 1 | |
| | RXYQ20* / RYYQ20* / RXYQ20* | | | | | | | 1 |
| Multi-combination with 2 outdoor units | RXYQ22* / RYYQ22* / RXYQ22* | | 1 | 1 | | | | |
| | RXYQ24* / RYYQ24* / RXYQ24* | 1 | | | | 1 | | |
| | RXYQ26* / RYYQ26* / RXYQ26* | | | 1 | 1 | | | |
| | RXYQ28* / RYYQ28* / RXYQ28* | | | 1 | | 1 | | |
| | RXYQ30* / RYYQ30* / RXYQ30* | | | 1 | | | 1 | |
| | RXYQ32* / RYYQ32* / RXYQ32* | | | | | 2 | | |
| | RXYQ34* / RYYQ34* / RXYQ34* | | | | | | 1 | 1 |
| | RXYQ36* / RYYQ36* / RXYQ36* | | | | | | | 1 |
| Multi-combination with 3 outdoor units | RXYQ38* / RYYQ38* / RXYQ38* | 1 | 1 | | | | | 1 |
| | RXYQ40* / RYYQ40* / RXYQ40* | | 1 | 1 | | | | 1 |
| | RXYQ42* / RYYQ42* / RXYQ42* | | | 1 | | 2 | | |
| | RXYQ44* / RYYQ44* | | | 1 | | 2 | | |
| | RXYQ46* / RYYQ46* | | | | 1 | 2 | | |
| | RXYQ48* / RYYQ48* | | | | | | 3 | |
| | RXYQ50* / RYYQ50* | | | | | | 2 | 1 |
| | RXYQ52* / RYYQ52* | | | | | | 1 | 2 |
| RXYQ54* / RYYQ54* | | | | | | | 3 | |

- Remark**
 RXYQ8~20 = Single continuous heating
 RYYQ22~54 Multi continuous heating
 RXYQ8~20 = Single non-continuous heating
 RXYQ22~54 Multi non-continuous heating
 RXYQ8~20 Single non-continuous heating replacement (VRV4-Q)
 RXYQ22~54 Multi non-continuous heating replacement (VRV4-Q)
 1) For single unit installation: RYYQ* units (continuous heating) and RXYQ* units (non-continuous heating)
 2) "Non-continuous heating" multi-outdoor-unit combinations consist of RXYQ8~20 units (e.g. RXYQ36*~RXYQ16*~RXYQ20*).
 3) "Continuous heating" multi-outdoor-unit combinations consist of RYM08~20 units (e.g. RYYQ36*~RYMQ16*~RYMQ20*).
 → RYM08~20 units can only be used in multi-outdoor-unit combinations and cannot be used as standalone units.
 4) RYYQ8~20* units cannot be used in multi-outdoor-unit combinations.
 5) RYYQ8~20 "Continuous heating" multi-outdoor-unit combinations cannot contain RXYQ* units.
 6) RXYQ8~20 "Non-continuous heating" multi-outdoor-unit combinations cannot contain RYM08~20* units.
 7) Multi "non-continuous heating" replacement models only consist of RXYQ8~20 modules (e.g. RXYQ36*~RXYQ16*~RXYQ20*).
 8) Replacement units cannot be combined with other units.
 9) T-series outdoor units and U-series outdoor units cannot share the same refrigerant circuit. When combining these units, make sure they are part of separate refrigerant circuits.

3D120060

RYYQ8-20U
RYMQ8-20U

Compatibility list: ·VRV4· heat pump - ·RA DX· indoor unit

| Wall mounted type | Emura | FTXJ20M FTXJ25M FTXJ35M FTXJ50M |
|----------------------|---------|--|
| | Stylish | FTXA20 FTXA25 FTXA35 FTXA42 FTXA50 |
| Ceiling/wall mounted | Flex | FLXS25B FLXS35B FLXS50B FLXS60B |
| Floor standing type | FVXM | FVXM25F FVXM35F FVXM50F |
| | Nexura | FVXG25K FVXG35K FVXG50K |

Remark

- The limitations on the use of ·RA DX· indoor units with the ·VRV4· Heat Pump are subject to the rules set out in drawings ·3D079543· and ·3D079540·.
- If you want to connect ·RA·/·SA· ·DX· cassette, ceiling-mounted, or duct indoor units, use their ·VRV DX· indoor unit equivalents instead.

3D082373D

4 Combination table

4 - 1 Combination Table

RXYQ-U
RYYQ-U
RYMQ-U

VRV4
Heat pump
Indoor unit combination restrictions
(1/2)

| Indoor unit combination pattern | -VRV* DX- indoor unit | -RA DX- indoor unit | Hydrobox unit | Air handling unit (AHU) ⁽³⁾ |
|----------------------------------|-----------------------|---------------------|----------------|--|
| -VRV* DX- indoor unit | O | O | O | O |
| -RA DX- indoor unit | O | O | X | X |
| Hydrobox unit | O | X | O ₁ | X |
| Air handling unit ⁽³⁾ | O | X | X | O ₂ |

O: Allowed
X: Not allowed

Notes

1. -VRV* DX- indoor unit
- When combining -VRV DX- indoor units with other types of indoor units, respect the following combination patterns:
Example
Allowed : (-VRV DX- indoor unit + -Hydrobox- unit) or (-VRV DX- indoor unit + -RA DX- indoor unit) or (-VRV DX- indoor unit + -AHU-)
Not allowed : [-VRV DX- indoor unit + (-RA DX- indoor unit & (-Hydrobox- unit or -AHU-))] or [-VRV DX- indoor unit + (-Hydrobox- unit & (-RA DX- indoor unit or -AHU-))]
2. O₁
- Only connect -Hydrobox- units to a -VRV IV- Heat Pump in combination with a -VRV DX- indoor unit.
→ Refer to the connection ratio restrictions (3D079540 & 3D117169-).
→ Connection with only Hydrobox units: refer to the Daikin Altherma solutions.
- Only connect -Hydrobox- units of the -HX* series.
→ -HXHD* series -Hydrobox- units are not allowed.
3. O₂
- Combination of -AHU- only + control box -EKEQFA- (the combination with -VRV DX- indoor units is not allowed; maximum -54-HP for -400 + 2x500- class -EKE XV- kit)
→ -X- control is possible (up to -3x [-EKE XV+EKEQFA* - boxes] can be connected to one outdoor unit (system)). No Variable Refrigerant Temperature control possible.
→ -Y- control is possible (up to -3x [-EKE XV+EKEQFA* - boxes] can be connected to one outdoor unit (system)). No Variable Refrigerant Temperature control possible.
→ -W- control is possible (up to -3x [-EKE XV+EKEQFA* - boxes] can be connected to one outdoor unit (system)). No Variable Refrigerant Temperature control possible.
- Combination of -AHU- only + control box -EKEQMA- (not combined with -VRV DX- indoor units)
→ Z- control is possible (the allowed number of [-EKE XV + EKEQMA- boxes] is determined by the connection ratio (90-110%) and the capacity of the outdoor unit.
4. Combination of -AHU- and -VRV DX- indoor units
→ Z- control is possible (-EKEQMA* - boxes are allowed, but with a limited connection ratio).
5. The combination of -AHU- with -Hydrobox- units or -RA DX- indoor units is not allowed.
6. (3) The following units are considered AHUs:
→ -EKE XV + EKEQ(MA/FA) + AHU- coil
→ -Biddle- air curtain
→ -FXMQ_MF- units

Information

- -VKM- units are considered to be regular -VRV DX- indoor units.

3D079543F

RXYQ-U
RYYQ-U
RYMQ-U

VRV4
Heat pump
Indoor unit combination restrictions
(2/2)

| Combination table | RYYQ* | RYYQ* | RXYQ* RXMLQ* RXYLQ* | RXYQ* RXMLQ* RXYLQ* |
|--|---------------------------|--------------------------|-------------------------------|------------------------------|
| | Single continuous heating | Multi continuous heating | Single non-continuous heating | Multi non-continuous heating |
| -VRV* DX- indoor unit | O | O | O | O |
| -RA DX- indoor unit | O | X | O | X |
| Hydrobox unit | O | O ₁ | O | O ₁ |
| Air handling unit (AHU) ⁽²⁾ | O | O | O | O |

O: Allowed
X: Not allowed

Notes

1. O₁
- Available upon request through the -SPN- procedure.
2. (2) The following units are considered AHUs:
→ -EKE XV + EKEQ(MA/FA) + AHU- coil
→ -Biddle- air curtain
→ -FXMQ_MF- units

3D079543F

4 Combination table

4 - 1 Combination Table

4

REMQ5U,REYQ8-20U,RXYQQ8-20U, RXYTQ8-16UYF,RYYQ8-20U,RYMQ8-20U

Unit combination restrictions: VRV4 outdoor units (all models) + 15-class indoor units

Units in scope: FXZQ15A and FXAQ15A.

1. In case the system contains these indoor units and the total connection ratio (CR) $\leq 100\%$: no special restrictions. Follow the restrictions that apply to regular VRV DX indoor units.
2. In case the system contains these indoor units and the total connection ratio (CR) $> 100\%$: special restrictions apply.
 - A. When the connection ratio (CR1) of the sum of all FXZQ15A and/or FXAQ15A units in the system $\leq 70\%$, and ALL other VRV DX indoor units have an individual capacity class > 50 : no special restrictions.
 - B. When the connection ratio (CR1) of the sum of all FXZQ15A and/or FXAQ15A units in the system $\leq 70\%$, and NOT ALL other VRV DX indoor units have an individual capacity class > 50 : the restrictions below apply.
 - $100\% < CR \leq 105\% \rightarrow$ CR1 of the sum of all FXZQ15A and/or FXAQ15A indoor units in the system must be $\leq 70\%$.
 - $105\% < CR \leq 110\% \rightarrow$ CR1 of the sum of all FXZQ15A and/or FXAQ15A indoor units in the system must be $\leq 60\%$.
 - $110\% < CR \leq 115\% \rightarrow$ CR1 of the sum of all FXZQ15A and/or FXAQ15A indoor units in the system must be $\leq 40\%$.
 - $115\% < CR \leq 120\% \rightarrow$ CR1 of the sum of all FXZQ15A and/or FXAQ15A indoor units in the system must be $\leq 25\%$.
 - $120\% < CR \leq 125\% \rightarrow$ CR1 of the sum of all FXZQ15A and/or FXAQ15A indoor units in the system must be $\leq 10\%$.
 - $125\% < CR \leq 130\% \rightarrow$ FXZQ15A and FXAQ15A cannot be used

REMARK

Only the 15-class indoor units explicitly mentioned on this page are in scope. Other indoor units follow the rules that apply to regular VRV DX indoor units.

3D104665

5 Capacity tables

5 - 1 Capacity Table Legend

In order to fulfill more your requirements on quick access of data in the format you require, we have developed a tool to consult capacity tables.

Below you can find the link to the capacity table database and an overview of all the tools we have to help you select the correct product:

- Capacity table database: lets you find back and export quickly the capacity information you are looking for based upon unit model, refrigerant temperature and connection ratio.

[Click here to access the capacity table viewer.](#)



- For more information about all our tools we offer [click here to see the overview](#) on my.daikin.eu



5 Capacity tables

5 - 2 Capacity Correction Factor

RXYQQ-U
RXYQ-U
RYYQ-U
RYMQ-U

VRV4 Heat pump Integrated heating capacity coefficient

The heating capacity tables do not take into account the capacity reduction in case of frost accumulation or defrost operation. The capacity values that take these factors into account, or in other words, the integrated heating capacity values, can be calculated as follows:

Formula

- A = Integrated heating capacity
- B = Capacity characteristics value (see table)
- C = Integrated correction factor for frost accumulation (see table)
- $A = B \cdot C$

Inlet air temperature of heat exchanger

| [°CDB/°CWB] | -7/-7,6 or less | -5/-5,6 | -3/-3,7 | 0/-0,7 | 3/2,2 | 5/4,1 | 7/6 |
|---|-----------------|---------|---------|--------|-------|-------|------|
| Integrated correction factor for frost accumulation C | | | | | | | |
| 8HP | 0,95 | 0,93 | 0,88 | 0,84 | 0,85 | 0,90 | 1,00 |
| 10HP | 0,95 | 0,93 | 0,87 | 0,79 | 0,80 | 0,88 | 1,00 |
| 12HP | 0,95 | 0,92 | 0,87 | 0,75 | 0,76 | 0,85 | 1,00 |
| 14HP | 0,95 | 0,92 | 0,86 | 0,72 | 0,73 | 0,84 | 1,00 |
| 16HP | 0,95 | 0,92 | 0,86 | 0,72 | 0,72 | 0,83 | 1,00 |
| 18HP | 0,95 | 0,93 | 0,88 | 0,84 | 0,85 | 0,90 | 1,00 |
| 20HP | 0,95 | 0,93 | 0,88 | 0,84 | 0,85 | 0,90 | 1,00 |
| 22HP | 0,95 | 0,92 | 0,87 | 0,77 | 0,78 | 0,86 | 1,00 |
| 24HP | 0,95 | 0,92 | 0,87 | 0,75 | 0,76 | 0,85 | 1,00 |
| 26HP | 0,95 | 0,92 | 0,86 | 0,73 | 0,74 | 0,84 | 1,00 |
| 28HP | 0,95 | 0,92 | 0,86 | 0,73 | 0,74 | 0,84 | 1,00 |
| 30HP | 0,95 | 0,93 | 0,87 | 0,80 | 0,81 | 0,88 | 1,00 |
| 32HP | 0,95 | 0,92 | 0,86 | 0,71 | 0,72 | 0,83 | 1,00 |
| 34HP | 0,95 | 0,92 | 0,87 | 0,78 | 0,79 | 0,87 | 1,00 |
| 36HP | 0,95 | 0,92 | 0,87 | 0,78 | 0,79 | 0,87 | 1,00 |
| 38HP | 0,95 | 0,93 | 0,88 | 0,83 | 0,84 | 0,89 | 1,00 |
| 40HP | 0,95 | 0,93 | 0,87 | 0,80 | 0,81 | 0,88 | 1,00 |
| 42HP | 0,95 | 0,92 | 0,86 | 0,73 | 0,74 | 0,84 | 1,00 |
| 44HP | 0,95 | 0,92 | 0,86 | 0,72 | 0,73 | 0,84 | 1,00 |
| 46HP | 0,95 | 0,92 | 0,86 | 0,72 | 0,72 | 0,83 | 1,00 |
| 48HP | 0,95 | 0,92 | 0,86 | 0,71 | 0,72 | 0,83 | 1,00 |
| 50HP | 0,95 | 0,92 | 0,87 | 0,76 | 0,77 | 0,86 | 1,00 |
| 52HP | 0,95 | 0,93 | 0,87 | 0,80 | 0,81 | 0,88 | 1,00 |
| 54HP | 0,95 | 0,93 | 0,88 | 0,84 | 0,85 | 0,90 | 1,00 |

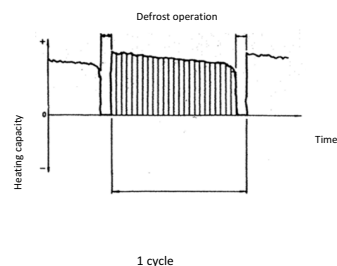

Notes

The figure shows the integrated heating capacity for a single cycle (from one defrost operation to the next).

When there is an accumulation of snow against the outdoor unit heat exchanger, there will always be a temporary reduction in capacity depending on the outdoor temperature (°C DB), relative humidity (RH) and the amount of frosting which occurs.

The multi-combination data 22°54HP corresponds with the standard multi-combination of drawing 3D079534.

3D079898A

5 Capacity tables

5 - 2 Capacity Correction Factor

RXYQQ8U
RXYQ8U
RYYQ8U
RYMQ8U

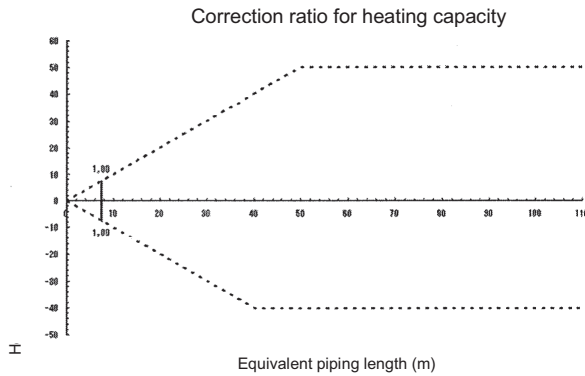
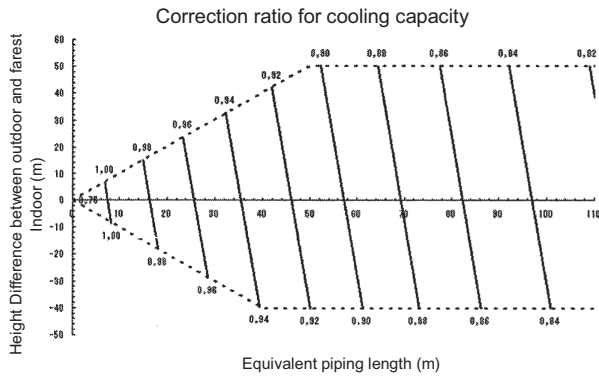

NOTES

- These figures illustrate the correction ratio for piping length in capacity for a standard indoor unit system at maximum load (with the thermostat set to maximum) under standard conditions. Moreover, under partial load conditions, there is only a minor deviation for the capacity correction ratio, shown in the above figures.
- With this outdoor unit, constant evaporating pressure control when cooling and constant condensing pressure control when heating is carried out.
- Method of calculating the capacity of the outdoor units
The maximum capacity of the system will be either the total capacity of the indoor units or the maximum capacity of the outdoor units as mentioned below, whichever is smaller.

Condition: Indoor connection ratio does not exceed 100%.

$$\boxed{\text{Maximum capacity of outdoor units}} = \boxed{\text{Capacity of outdoor units from capacity table at the 100\% connection ratio}} \times \boxed{\text{Correction ratio of piping to furthest indoor}}$$

Condition: Indoor connection ratio exceeds 100%.

$$\boxed{\text{Maximum capacity of outdoor units}} = \boxed{\text{Capacity of outdoor units from capacity table at installed connection ratio}} \times \boxed{\text{Correction ratio of piping to furthest indoor}}$$

- When level difference is 50 m or more (see installation manual and 3D079540 / 3D079543) and equivalent pipe length is 90 m or more, the diameter of the main gas and liquid pipes (outdoor unit - branch sections) must be increased. For new diameters, see below.

| Model | Gas | Liquid |
|-------|------|--------|
| 8HP | 22.2 | 12.7 |

- When the pipe length after the first refrigerant branch kit is more than 40 m, pipe size between first and final branch kit must be increased (only for VRV DX indoor units; details see installation manual).
*Refer to the installation manual for allowed system setups and rules for dedicated indoor connection types.

Diameter of main pipes (standard size)

| Model | Gas | Liquid |
|-------|------|--------|
| 8HP | 19.1 | 9.5 |

- Equivalent length used in the above figures is based upon the following equivalent length

$$\boxed{\text{Equivalent piping length}} = \boxed{\text{Equivalent length of main pipe}} \times \boxed{\text{Correction factor}} + \boxed{\text{Equivalent length of branch pipes}}$$

Choose the correction factor from the following table. When cooling capacity is calculated: gas pipe size. When heating capacity is calculated: liquid pipe size

| | Correction factor | |
|-----------------------|-------------------|---------------|
| | Standard size | Size increase |
| Cooling (gas pipe) | 1.0 | 0.5 |
| Heating (liquid pipe) | 1.0 | 0.5 |

Example

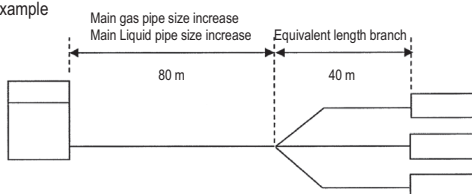

In the above case (Cooling) Overall equivalent length = 80 m x 0.5 + 40 m = 80 m
(Heating) Overall equivalent length = 80 m x 0.5 + 40 m = 80 m
The rate of change in cooling capacity when height difference = 0 is thus approximately 0.86
heating capacity when height difference = 0 is thus approximately 1.0

3D079897A

5 Capacity tables

5 - 2 Capacity Correction Factor

5

RXYQQ10U
RXYQ10U
RYYQ10U
RYSMQ10U

Correction ratio for cooling capacity

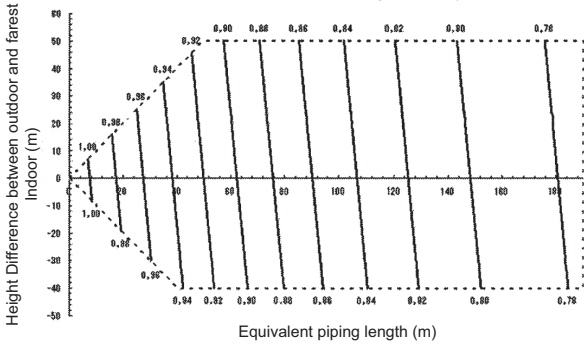

Correction ratio for heating capacity

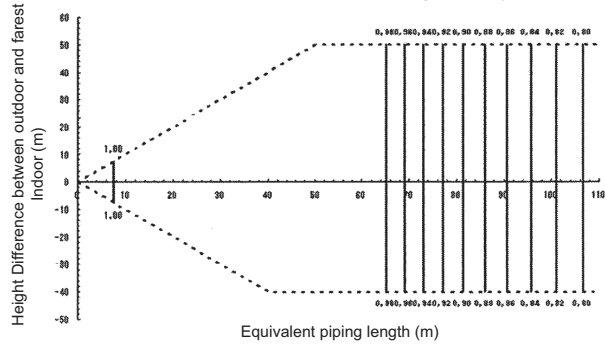

NOTES

1. These figures illustrate the correction ratio for piping length in capacity for a standard indoor unit system at maximum load (with the thermostat set to maximum) under standard conditions. Moreover, under partial load conditions, there is only a minor deviation for the capacity correction ratio, shown in the above figures.

2. With this outdoor unit, constant evaporating pressure control when cooling and constant condensing pressure control when heating is carried out.

3. Method of calculating the capacity of the outdoor units

The maximum capacity of the system will be either the total capacity of the indoor units or the maximum capacity of the outdoor units as mentioned below, whichever is smaller.

Condition: Indoor connection ratio does not exceed 100%.

$$\text{Maximum capacity of outdoor units} = \text{Capacity of outdoor units from capacity table at the 100\% connection ratio} \times \text{Correction ratio of piping to furthest indoor}$$

Condition: Indoor connection ratio exceeds 100%.

$$\text{Maximum capacity of outdoor units} = \text{Capacity of outdoor units from capacity table at installed connection ratio} \times \text{Correction ratio of piping to furthest indoor}$$

4. When level difference is 50 m or more (see installation manual and 3D079540 / 3D079543) and equivalent pipe length is 90 m or more, the diameter of the main gas and liquid pipes (outdoor unit - branch sections) must be increased. For new diameters, see below.

| Model | Gas | Liquid |
|---------|-------|--------|
| RXYQ10P | 25.4* | 12.7 |

*If not available on site, do not increase. If not increased correction factor should be applied to the equivalent length (see note 6).

5. When the pipe length after the first refrigerant branch kit is more than 40 m, pipe size between first and final branch kit must be increased (only for VRV DX indoor units; details see installation manual).

*Refer to the installation manual for allowed system setups and rules for dedicated indoor connection types.

Diameter of main pipes (standard size)

| Model | Gas | Liquid |
|-------|------|--------|
| 10 HP | 22.2 | 9.5 |

6. Equivalent length used in the above figures is based upon the following equivalent length

$$\text{Equivalent piping length} = \text{Equivalent length of main pipe} \times \text{Correction factor} + \text{Equivalent length of branch pipes}$$

Choose the correction factor from the following table. When cooling capacity is calculated: gas pipe size When heating capacity is calculated: liquid pipe size

| | Correction factor | |
|-----------------------|-------------------|---------------|
| | Standard size | Size increase |
| Cooling (gas pipe) | 1.0 | 0.5 |
| Heating (liquid pipe) | 1.0 | 0.5 |

Example

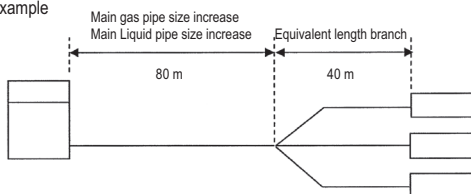

In the above case (Cooling) Overall equivalent length = 80 m x 0.5 + 40 m = 80 m

(Heating) Overall equivalent length = 80 m x 0.5 + 40 m = 80 m

The rate of change in cooling capacity when height difference = 0 is thus approximately 0.87
heating capacity when height difference = 0 is thus approximately 0.90

5 Capacity tables

5 - 2 Capacity Correction Factor

RXYQQ12,14,16,24,36U
 RXYQ12,14,24,36U
 RYYQ12,14,24,36U
 RYM12,14U

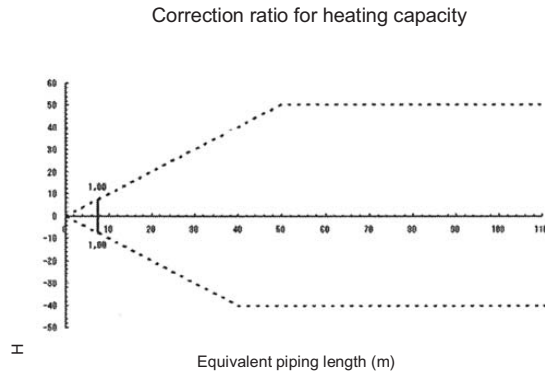
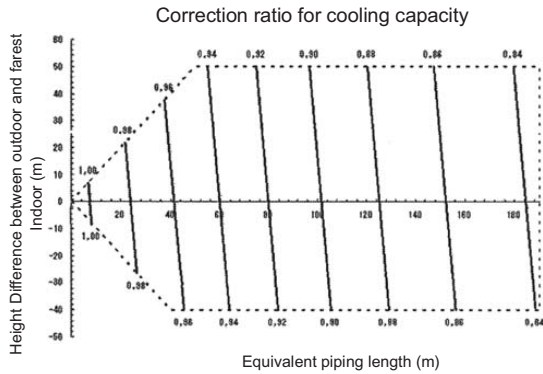

NOTES

- These figures illustrate the correction ratio for piping length in capacity for a standard indoor unit system at maximum load (with the thermostat set to maximum) under standard conditions. Moreover, under partial load conditions, there is only a minor deviation for the capacity correction ratio, shown in the above figures.
- With this outdoor unit, constant evaporating pressure control when cooling and constant condensing pressure control when heating is carried out.
- Method of calculating the capacity of the outdoor units
 The maximum capacity of the system will be either the total capacity of the indoor units or the maximum capacity of the outdoor units as mentioned below, whichever is smaller.

Condition: Indoor connection ratio does not exceed 100%.

$$\text{Maximum capacity of outdoor units} = \text{Capacity of outdoor units from capacity table at the 100\% connection ratio} \times \text{Correction ratio of piping to furthest indoor}$$

Condition: Indoor connection ratio exceeds 100%.

$$\text{Maximum capacity of outdoor units} = \text{Capacity of outdoor units from capacity table at installed connection ratio} \times \text{Correction ratio of piping to furthest indoor}$$

- When level difference is 50 m or more (see installation manual and 3D079540 / 3D079543) and equivalent pipe length is 90 m or more, the diameter of the main gas and liquid pipes (outdoor unit - branch sections) must be increased. For new diameters, see below.

| Model | Gas | Liquid |
|-------|------|--------|
| 12 HP | 28.6 | 15.9 |
| 14 HP | 28.6 | 15.9 |
| 24 HP | 34.9 | 19.1 |
| 36 HP | 41.3 | 22.2 |

- When the pipe length after the first refrigerant branch kit is more than 40 m, pipe size between first and final branch kit must be increased (only for VRV DX indoor units; details see installation manual).

*Refer to the installation manual for allowed system setups and rules for dedicated indoor connection types.

Diameter of main pipes (standard size)

| Model | Gas | Liquid |
|-------|------|--------|
| 12 HP | 28.6 | 12.7 |
| 14 HP | 28.6 | 12.7 |
| 24 HP | 34.9 | 15.9 |
| 36 HP | 41.3 | 19.1 |

- Equivalent length used in the above figures is based upon the following equivalent length

$$\text{Equivalent piping length} = \text{Equivalent length of main pipe} \times \text{Correction factor} + \text{Equivalent length of branch pipes}$$

Choose a correction factor from the following table. When cooling capacity is calculated: gas pipe size. When heating capacity is calculated: liquid pipe size

| | Correction factor | |
|-----------------------|-------------------|---------------|
| | Standard size | Size increase |
| Cooling (gas pipe) | 1,0 | 0,5 |
| Heating (liquid pipe) | 1,0 | 0,5 |

Example

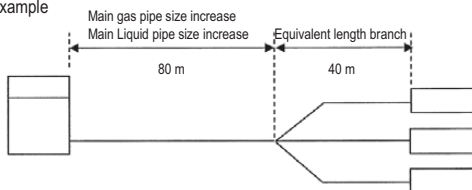

In the above case (Cooling) Overall equivalent length = 80 m x 1.0 + 40 m = 120 m
 (Heating) Overall equivalent length = 80 m x 0.5 + 40 m = 80 m
 The rate of change in cooling capacity when height difference = 0 is thus approximately 0.89
 heating capacity when height difference = 0 is thus approximately 1.0

5 Capacity tables

5 - 2 Capacity Correction Factor

5

RXYQQ16U
RXYQ16U
RYYQ16U
RYMQ16U

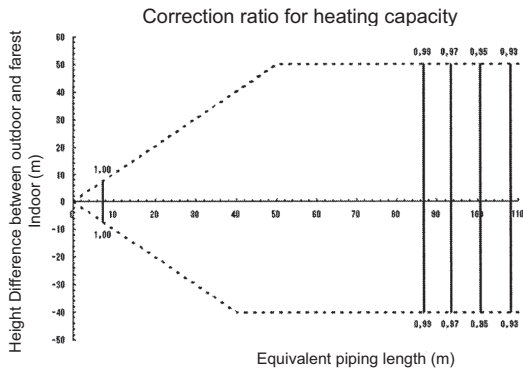
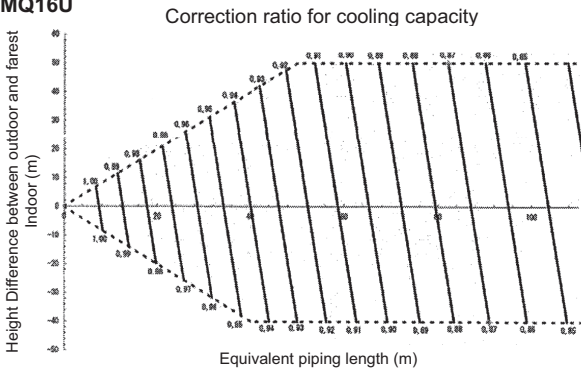

NOTES

- These figures illustrate the correction ratio for piping length in capacity for a standard indoor unit system at maximum load (with the thermostat set to maximum) under standard conditions. Moreover, under partial load conditions, there is only a minor deviation for the capacity correction ratio, shown in the above figures.
- With this outdoor unit, constant evaporating pressure control when cooling and constant condensing pressure control when heating is carried out.
- Method of calculating the capacity of the outdoor units
The maximum capacity of the system will be either the total capacity of the indoor units or the maximum capacity of the outdoor units as mentioned below, whichever is smaller.

Condition: Indoor connection ratio does not exceed 100%.

$$\text{Maximum capacity of outdoor units} = \text{Capacity of outdoor units from capacity table at the 100\% connection ratio} \times \text{Correction ratio of piping to furthest indoor}$$

Condition: Indoor connection ratio exceeds 100%.

$$\text{Maximum capacity of outdoor units} = \text{Capacity of outdoor units from capacity table at installed connection ratio} \times \text{Correction ratio of piping to furthest indoor}$$

- When level difference is 50 m or more (see installation manual and 3D079540 / 3D079543) and equivalent pipe length is 90 m or more, the diameter of the main gas and liquid pipes (outdoor unit - branch sections) must be increased. For new diameters, see below.

| Model | Gas | Liquid |
|-------|-------|--------|
| 16 HP | 31.8* | 15.9 |

*If not available on site, do not increase. If not increased correction factor should be applied to the equivalent length (see note 6).

- When the pipe length after the first refrigerant branch kit is more than 40 m, pipe size between first and final branch kit must be increased (only for VRV DX indoor units; details see installation manual).
*Refer to the installation manual for allowed system setups and rules for dedicated indoor connection types.

Diameter of main pipes (standard size)

| Model | Gas | Liquid |
|-------|------|--------|
| 16 HP | 28.6 | 12.7 |

- Equivalent length used in the above figures is based upon the following equivalent length

$$\text{Equivalent piping length} = \text{Equivalent length of main pipe} \times \text{Correction factor} + \text{Equivalent length of branch pipes}$$

Choose a correction factor from the following table. When cooling capacity is calculated: gas pipe size When heating capacity is calculated: liquid pipe size

| | Correction factor | |
|-----------------------|-------------------|---------------|
| | Standard size | Size increase |
| Cooling (gas pipe) | 1.0 | 0.5 |
| Heating (liquid pipe) | 1.0 | 0.5 |

Example

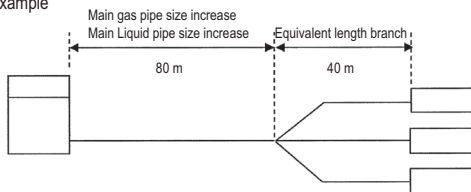

In the above case (Cooling) Overall equivalent length = 80 m x 1.0 + 40 m = 80 m
(Heating) Overall equivalent length = 80 m x 0.5 + 40 m = 80 m
The rate of change in cooling capacity when height difference = 0 is thus approximately 0.88
heating capacity when height difference = 0 is thus approximately 0.99

5 Capacity tables

5 - 2 Capacity Correction Factor

RXYQQ18,26,28,30,38,40,42,44U
 RXYQ18,26,28,30,38,40,42,44U
 RYYQ18,26,28,30,38,40,42,44U
 RYMQ18U

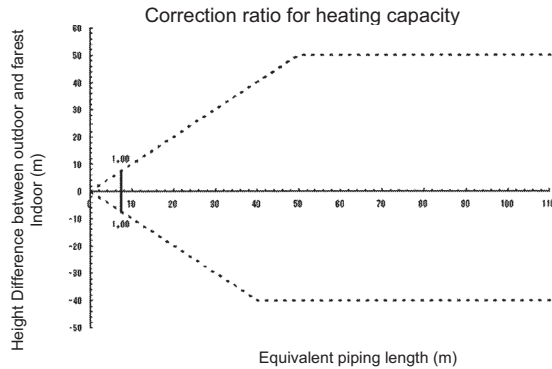
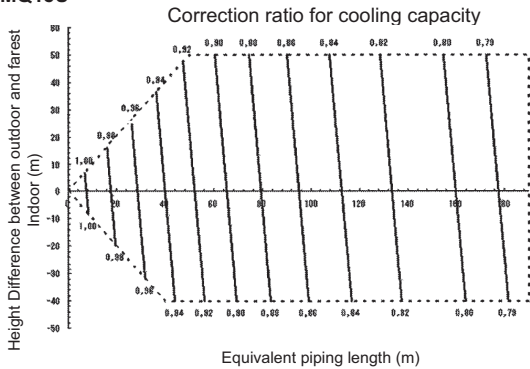

NOTES

- These figures illustrate the correction ratio for piping length in capacity for a standard indoor unit system at maximum load (with the thermostat set to maximum) under standard conditions. Moreover, under partial load conditions, there is only a minor deviation for the capacity correction ratio, shown in the above figures.
- With this outdoor unit, constant evaporating pressure control when cooling and constant condensing pressure control when heating is carried out.
- Method of calculating the capacity of the outdoor units
 The maximum capacity of the system will be either the total capacity of the indoor units or the maximum capacity of the outdoor units as mentioned below, whichever is smaller.

Condition: Indoor connection ratio does not exceed 100%.

$$\text{Maximum capacity of outdoor units} = \text{Capacity of outdoor units from capacity table at the 100\% connection ratio} \times \text{Correction ratio of piping to furthest indoor}$$

Condition: Indoor connection ratio exceeds 100%.

$$\text{Maximum capacity of outdoor units} = \text{Capacity of outdoor units from capacity table at installed connection ratio} \times \text{Correction ratio of piping to furthest indoor}$$

- When level difference is 50 m or more (see installation manual and 3D079540 / 3D079543) and equivalent pipe length is 90 m or more, the diameter of the main gas and liquid pipes (outdoor unit - branch sections) must be increased. For new diameters, see below.

| Model | Gas | Liquid |
|----------|-------|--------|
| 18 HP | 31.8* | 19.1 |
| 26-30 HP | 38.1* | 22.2 |
| 38-44 HP | 41.3 | 22.2 |

*If not available on site, do not increase. If not increased correction factor should be applied to the equivalent length (see note 6).

- When the pipe length after the first refrigerant branch kit is more than 40 m, pipe size between first and final branch kit must be increased (only for VRV DX indoor units; details see installation manual).

*Refer to the installation manual for allowed system setups and rules for dedicated indoor connection types.

Diameter of main pipes (standard size)

| Model | Gas | Liquid |
|----------|------|--------|
| 18 HP | 28.6 | 15.9 |
| 26-30 HP | 34.9 | 19.1 |
| 38-44 HP | 41.3 | 19.1 |

- Equivalent length used in the above figures is based upon the following equivalent length

$$\text{Equivalent piping length} = \text{Equivalent length of main pipe} \times \text{Correction factor} + \text{Equivalent length of branch pipes}$$

Choose the correction factor from the following table. When cooling capacity is calculated: gas pipe size. When heating capacity is calculated: liquid pipe size

| | Correction factor | |
|-----------------------|-------------------|---------------|
| | Standard size | Size increase |
| Cooling (gas pipe) | 1.0 | 0.5 |
| Heating (liquid pipe) | 1.0 | 0.5 |

Example

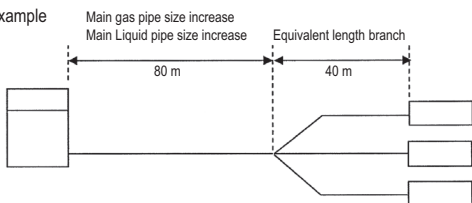

In the above case (for RXYQ38-44) (Cooling) Overall equivalent length = 80 m x 1.0 + 40 m = 120 m
 (Heating) Overall equivalent length = 80 m x 0.5 + 40 m = 80 m
 The rate of change in cooling capacity when height difference = 0 is thus approximately 0.83
 heating capacity when height difference = 0 is thus approximately 1.0

3D079897A

5 Capacity tables

5 - 2 Capacity Correction Factor

5

RXYQQ20,32,34U
 RXYQ20,32,34U
 RYYQ20,32,34U
 RYMQ20,32,34U

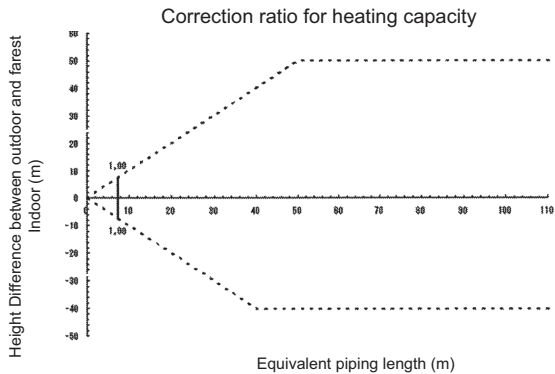
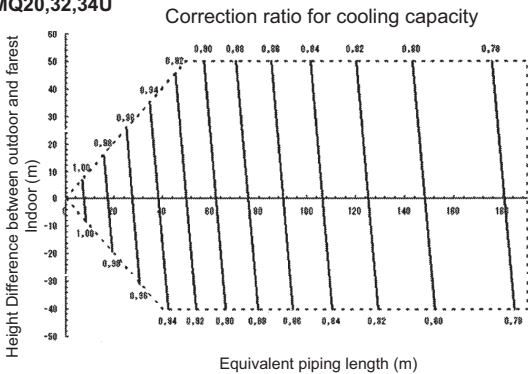

NOTES

- These figures illustrate the correction ratio for piping length in capacity for a standard indoor unit system at maximum load (with the thermostat set to maximum) under standard conditions. Moreover, under partial load conditions, there is only a minor deviation for the capacity correction ratio, shown in the above figures.
- With this outdoor unit, constant evaporating pressure control when cooling and constant condensing pressure control when heating is carried out.
- Method of calculating the capacity of the outdoor units
 The maximum capacity of the system will be either the total capacity of the indoor units or the maximum capacity of the outdoor units as mentioned below, whichever is smaller.

Condition: Indoor connection ratio does not exceed 100%.

$$\text{Maximum capacity of outdoor units} = \text{Capacity of outdoor units from capacity table at the 100\% connection ratio} \times \text{Correction ratio of piping to furthest indoor}$$

Condition: Indoor connection ratio exceeds 100%.

$$\text{Maximum capacity of outdoor units} = \text{Capacity of outdoor units from capacity table at installed connection ratio} \times \text{Correction ratio of piping to furthest indoor}$$

- When level difference is 50 m or more (see installation manual and 3D079540 / 3D079543) and equivalent pipe length is 90 m or more, the diameter of the main gas and liquid pipes (outdoor unit - branch sections) must be increased. For new diameters, see below.

| Model | Gas | Liquid |
|----------|-------|--------|
| 20 HP | 31.8* | 19.1 |
| 32/34 HP | 38.1* | 22.2 |

*If not available on site, do not increase. If not increased correction factor should be applied to the equivalent length (see note 6).

- When the pipe length after the first refrigerant branch kit is more than 40 m, pipe size between first and final branch kit must be increased (only for VRV DX indoor units; details see installation manual).

*Refer to the installation manual for allowed system setups and rules for dedicated indoor connection types.

Diameter of main pipes (standard size)

| Model | Gas | Liquid |
|----------|------|--------|
| 20 HP | 28.6 | 15.9 |
| 32/34 HP | 34.9 | 19.1 |

- Equivalent length used in the above figures is based upon the following equivalent length

$$\text{Equivalent piping length} = \text{Equivalent length of main pipe} \times \text{Correction factor} + \text{Equivalent length of branch pipes}$$

Choose a correction factor from the following table. When cooling capacity is calculated: gas pipe size When heating capacity is calculated: liquid pipe size

| | Correction factor | |
|-----------------------|-------------------|---------------|
| | Standard size | Size increase |
| Cooling (gas pipe) | 1.0 | 0.5 |
| Heating (liquid pipe) | 1.0 | 0.5 |

Example

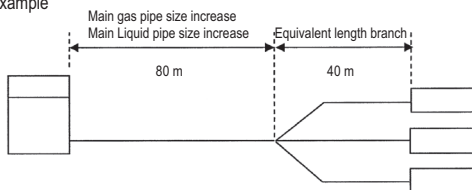

In the above case (Cooling) Overall equivalent length = 80 m x 0.5 + 40 m = 80 m
 (Heating) Overall equivalent length = 80 m x 0.5 + 40 m = 80 m

The rate of change in cooling capacity when height difference = 0 is thus approximately 0.88
 heating capacity when height difference = 0 is thus approximately 1.0

5 Capacity tables

5 - 2 Capacity Correction Factor

RXYQQ22U
RXYQ22U
RYYQ22U
RYMQ22U

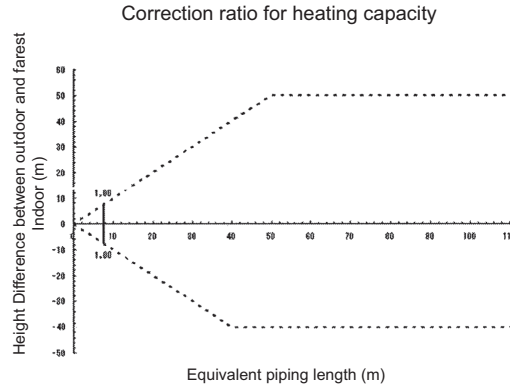
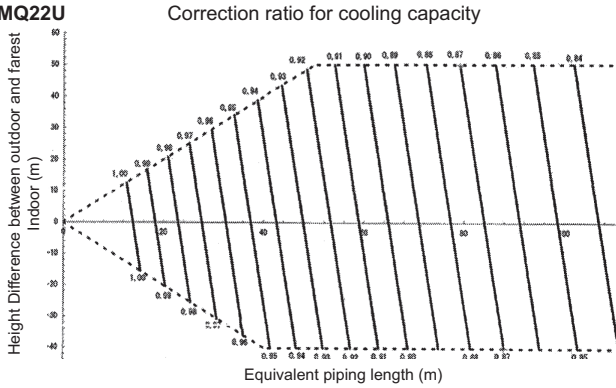

NOTES

- These figures illustrate the correction ratio for piping length in capacity for a standard indoor unit system at maximum load (with the thermostat set to maximum) under standard conditions. Moreover, under partial load conditions, there is only a minor deviation for the capacity correction ratio, shown in the above figures.
- With this outdoor unit, constant evaporating pressure control when cooling and constant condensing pressure control when heating is carried out.
- Method of calculating the capacity of the outdoor units
The maximum capacity of the system will be either the total capacity of the indoor units or the maximum capacity of the outdoor units as mentioned below, whichever is smaller.

Condition: Indoor connection ratio does not exceed 100%.

$$\text{Maximum capacity of outdoor units} = \text{Capacity of outdoor units from capacity table at the 100\% connection ratio} \times \text{Correction ratio of piping to furthest indoor}$$

Condition: Indoor connection ratio exceeds 100%.

$$\text{Maximum capacity of outdoor units} = \text{Capacity of outdoor units from capacity table at installed connection ratio} \times \text{Correction ratio of piping to furthest indoor}$$

- When level difference is 50 m or more (see installation manual and 3D079540 / 3D079543) and equivalent pipe length is 90 m or more, the diameter of the main gas and liquid pipes (outdoor unit - branch sections) must be increased. For new diameters, see below.

| Model | Gas | Liquid |
|-------|-------|--------|
| 22 HP | 31.8* | 19.1 |

* If not available on site, do not increase, if not increased, no correction factor should be applied to the equivalent length (see note 6).

- When the pipe length after the first refrigerant branch kit is more than 40 m, pipe size between first and final branch kit must be increased (only for VRV DX indoor units; details see installation manual).

*Refer to the installation manual for allowed system setups and rules for dedicated indoor connection types.

Diameter of main pipes (standard size)

| Model | Gas | Liquid |
|-------|------|--------|
| 22 HP | 28.6 | 15.9 |

- Equivalent length used in the above figures is based upon the following equivalent length

$$\text{Overall equivalent length} = \text{Equivalent length of main pipe} \times \text{Correction factor} + \text{Equivalent length of branch pipes}$$

Choose a correction factor from the following table. When cooling capacity is calculated: gas pipe size When heating capacity is calculated: liquid pipe size

| | Correction factor | |
|-----------------------|-------------------|---------------|
| | Standard size | Size increase |
| Cooling (gas pipe) | 1.0 | 0.5 |
| Heating (liquid pipe) | 1.0 | 0.5 |

Example

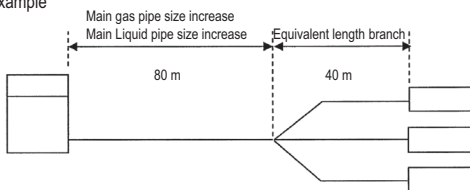

In the above case (Cooling) Overall equivalent length = 80 m x 0.5 + 40 m = 80 m
(Heating) Overall equivalent length = 80 m x 0.5 + 40 m = 80 m

The rate of change in cooling capacity when height difference = 0 is thus approximately 0.88
heating capacity when height difference = 0 is thus approximately 1.0

5 Capacity tables

5 - 2 Capacity Correction Factor

5

RYYQ46U, RXYQ46U

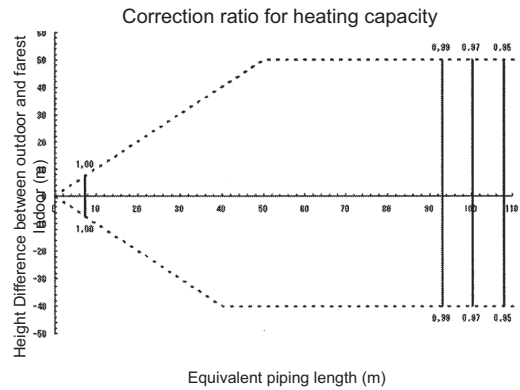
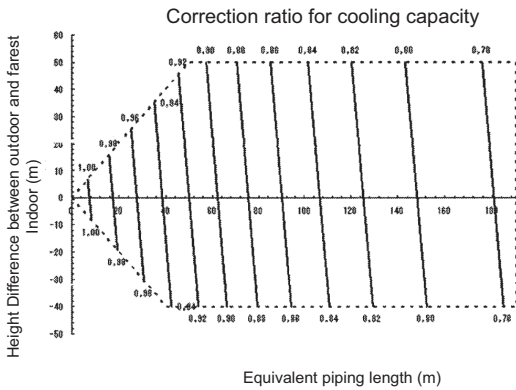

NOTES

- These figures illustrate the correction ratio for piping length in capacity for a standard indoor unit system at maximum load (with the thermostat set to maximum) under standard conditions. Moreover, under partial load conditions, there is only a minor deviation for the capacity correction ratio, shown in the above figures.
- With this outdoor unit, constant evaporating pressure control when cooling and constant condensing pressure control when heating is carried out.
- Method of calculating the capacity of the outdoor units
The maximum capacity of the system will be either the total capacity of the indoor units or the maximum capacity of the outdoor units as mentioned below, whichever is smaller.

Condition: Indoor connection ratio does not exceed 100%.

$$\text{Maximum capacity of outdoor units} = \text{Capacity of outdoor units from capacity table at the 100\% connection ratio} \times \text{Correction ratio of piping to furthest indoor}$$

Condition: Indoor connection ratio exceeds 100%.

$$\text{Maximum capacity of outdoor units} = \text{Capacity of outdoor units from capacity table at installed connection ratio} \times \text{Correction ratio of piping to furthest indoor}$$

- When level difference is 50 m or more (see installation manual and 3D079540 / 3D079543) and equivalent pipe length is 90 m or more, the diameter of the main gas and liquid pipes (outdoor unit - branch sections) must be increased. For new diameters, see below.

| Model | Gas | Liquid |
|-------|------|--------|
| 46 HP | 41.3 | 22.2 |

- When the pipe length after the first refrigerant branch kit is more than 40 m, pipe size between first and final branch kit must be increased (only for VRV DX indoor units; details see installation manual).

*Refer to the installation manual for allowed system setups and rules for dedicated indoor connection types.

Diameter of main pipes (standard size)

| Model | Gas | Liquid |
|-------|------|--------|
| 46 HP | 41.3 | 19.1 |

- Equivalent length used in the above figures is based upon the following equivalent length

$$\text{Equivalent piping length} = \text{Equivalent length of main pipe} \times \text{Correction factor} + \text{Equivalent length of branch pipes}$$

Choose a correction factor from the following table. When cooling capacity is calculated: gas pipe size When heating capacity is calculated: liquid pipe size

| | Correction factor | |
|-----------------------|-------------------|---------------|
| | Standard size | Size increase |
| Cooling (gas pipe) | 1.0 | 0.5 |
| Heating (liquid pipe) | 1.0 | 0.5 |

Example

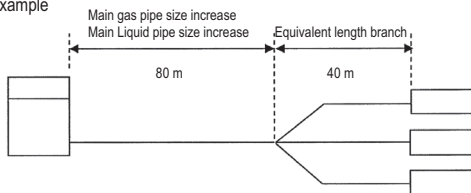

In the above case (Cooling) Overall equivalent length = 80 m x 1.0 + 40 m = 120 m

(Heating) Overall equivalent length = 80 m x 0.5 + 40 m = 80 m

The rate of change in cooling capacity when height difference = 0 is thus approximately 0.83 heating capacity when height difference = 0 is thus approximately 1.0

3D079897A

5 Capacity tables

5 - 2 Capacity Correction Factor

RYYQ48U, RXYQQ48U, RXYQ48U

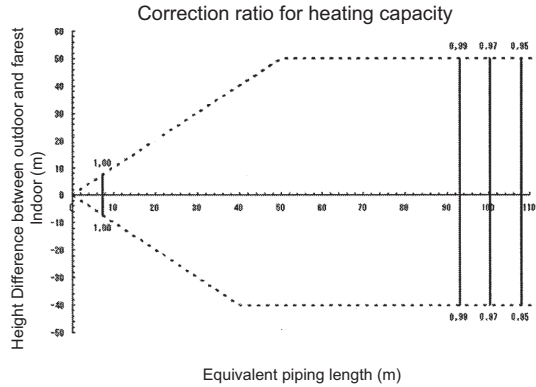
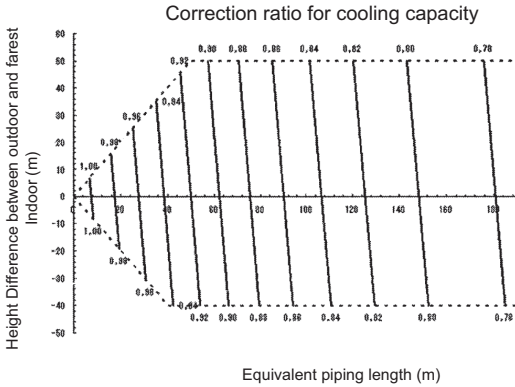

3D079897A

NOTES

- These figures illustrate the correction ratio for piping length in capacity for a standard indoor unit system at maximum load (with the thermostat set to maximum) under standard conditions. Moreover, under partial load conditions, there is only a minor deviation for the capacity correction ratio, shown in the above figures.
- With this outdoor unit, constant evaporating pressure control when cooling and constant condensing pressure control when heating is carried out.
- Method of calculating the capacity of the outdoor units
The maximum capacity of the system will be either the total capacity of the indoor units or the maximum capacity of the outdoor units as mentioned below, whichever is smaller.

Condition: Indoor connection ratio does not exceed 100%.

$$\text{Maximum capacity of outdoor units} = \text{Capacity of outdoor units from capacity table at the 100\% connection ratio} \times \text{Correction ratio of piping to furthest indoor}$$

Condition: Indoor connection ratio exceeds 100%.

$$\text{Maximum capacity of outdoor units} = \text{Capacity of outdoor units from capacity table at installed connection ratio} \times \text{Correction ratio of piping to furthest indoor}$$

- When level difference is 50 m or more (see installation manual and 3D079540 / 3D079543) and equivalent pipe length is 90 m or more, the diameter of the main gas and liquid pipes (outdoor unit - branch sections) must be increased. For new diameters, see below.

| Model | Gas | Liquid |
|-------|------|--------|
| 48 HP | 41.3 | 22.2 |

- When the pipe length after the first refrigerant branch kit is more than 40 m, pipe size between first and final branch kit must be increased (only for VRV DX indoor units; details see installation manual).

*Refer to the installation manual for allowed system setups and rules for dedicated indoor connection types.

Diameter of main pipes (standard size)

| Model | Gas | Liquid |
|-------|------|--------|
| 48 HP | 41.3 | 19.1 |

- Equivalent length used in the above figures is based upon the following equivalent length

$$\text{Equivalent piping length} = \text{Equivalent length of main pipe} \times \text{Correction factor} + \text{Equivalent length of branch pipes}$$

Choose a correction factor from the following table. When cooling capacity is calculated: gas pipe size When heating capacity is calculated: liquid pipe size

| | Correction factor | |
|-----------------------|-------------------|---------------|
| | Standard size | Size increase |
| Cooling (gas pipe) | 1.0 | 0.5 |
| Heating (liquid pipe) | 1.0 | 0.5 |

Example

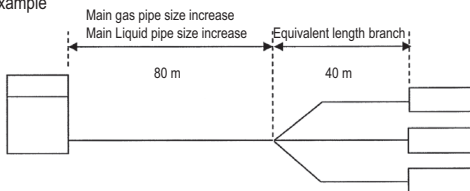

In the above case (Cooling) Overall equivalent length = 80 m x 1.0 + 40 m = 120 m
 (Heating) Overall equivalent length = 80 m x 0.5 + 40 m = 80 m
 The rate of change in cooling capacity when height difference = 0 is thus approximately 0.83
 heating capacity when height difference = 0 is thus approximately 0.97

5 Capacity tables

5 - 2 Capacity Correction Factor

5

RYYQ50U, RXYQ50U,
RXYQ50U

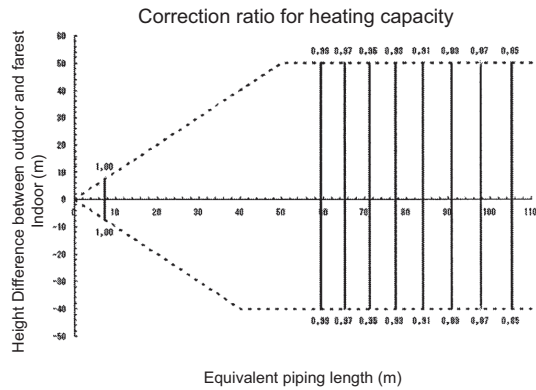
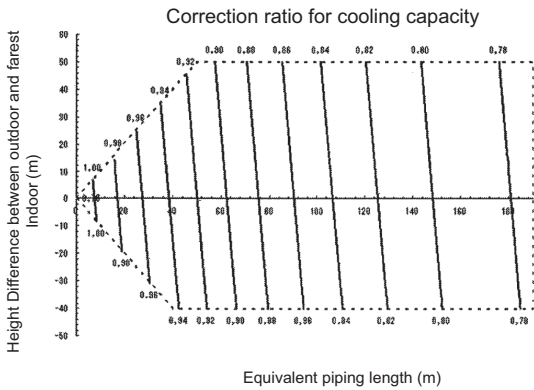

3D079897A

NOTES

- These figures illustrate the correction ratio for piping length in capacity for a standard indoor unit system at maximum load (with the thermostat set to maximum) under standard conditions. Moreover, under partial load conditions, there is only a minor deviation for the capacity correction ratio, shown in the above figures.
- With this outdoor unit, constant evaporating pressure control when cooling and constant condensing pressure control when heating is carried out.
- Method of calculating the capacity of the outdoor units
The maximum capacity of the system will be either the total capacity of the indoor units or the maximum capacity of the outdoor units as mentioned below, whichever is smaller.

Condition: Indoor connection ratio does not exceed 100%.

$$\text{Maximum capacity of outdoor units} = \text{Capacity of outdoor units from capacity table at the 100\% connection ratio} \times \text{Correction ratio of piping to furthest indoor}$$

Condition: Indoor connection ratio exceeds 100%.

$$\text{Maximum capacity of outdoor units} = \text{Capacity of outdoor units from capacity table at installed connection ratio} \times \text{Correction ratio of piping to furthest indoor}$$

- When level difference is 50 m or more (see installation manual and 3D079540 / 3D079543) and equivalent pipe length is 90 m or more, the diameter of the main gas and liquid pipes (outdoor unit - branch sections) must be increased. For new diameters, see below.

| Model | Gas | Liquid |
|-------|------|--------|
| 50 HP | 41.3 | 22.2 |

- When the pipe length after the first refrigerant branch kit is more than 40 m, pipe size between first and final branch kit must be increased (only for VRV DX indoor units; details see installation manual).

*Refer to the installation manual for allowed system setups and rules for dedicated indoor connection types.

Diameter of main pipes (standard size)

| Model | Gas | Liquid |
|-------|------|--------|
| 50 HP | 41.3 | 19.1 |

- Equivalent length used in the above figures is based upon the following equivalent length

$$\text{Equivalent piping length} = \text{Equivalent length of main pipe} \times \text{Correction factor} + \text{Equivalent length of branch pipes}$$

Choose a correction factor from the following table. When cooling capacity is calculated: gas pipe size When heating capacity is calculated: liquid pipe size

| | Correction factor | |
|-----------------------|-------------------|---------------|
| | Standard size | Size increase |
| Cooling (gas pipe) | 1.0 | 0.5 |
| Heating (liquid pipe) | 1.0 | 0.5 |

Example

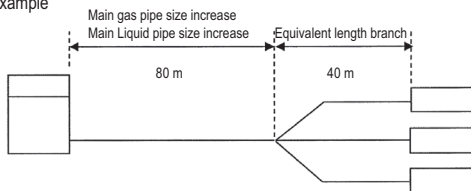

In the above case (Cooling) Overall equivalent length = 80 m x 1.0 + 40 m = 120 m
(Heating) Overall equivalent length = 80 m x 0.5 + 40 m = 80 m
The rate of change in cooling capacity when height difference = 0 is thus approximately 0.83
heating capacity when height difference = 0 is thus approximately 0.92

5 Capacity tables

5 - 2 Capacity Correction Factor

RYYQ52U, RXYQQ52U, RXYQ52U

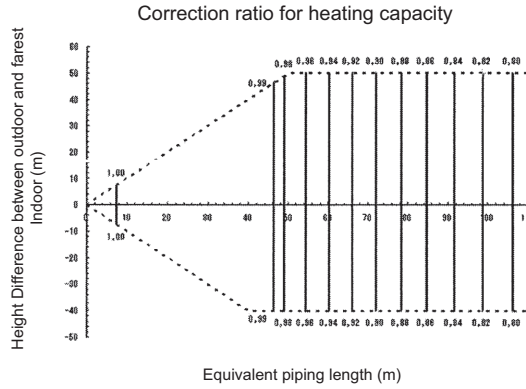
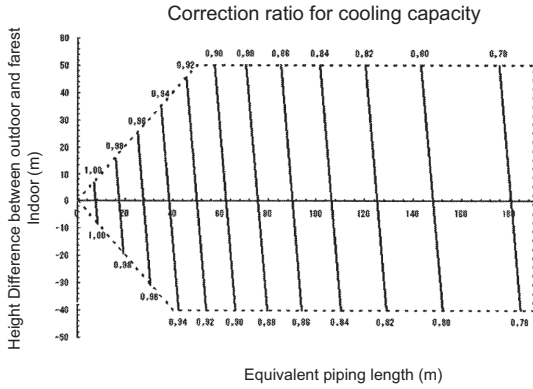

3D079897A

NOTES

- These figures illustrate the correction ratio for piping length in capacity for a standard indoor unit system at maximum load (with the thermostat set to maximum) under standard conditions. Moreover, under partial load conditions, there is only a minor deviation for the capacity correction ratio, shown in the above figures.
- With this outdoor unit, constant evaporating pressure control when cooling and constant condensing pressure control when heating is carried out.
- Method of calculating the capacity of the outdoor units
The maximum capacity of the system will be either the total capacity of the indoor units or the maximum capacity of the outdoor units as mentioned below, whichever is smaller.

Condition: Indoor connection ratio does not exceed 100%.

$$\text{Maximum capacity of outdoor units} = \text{Capacity of outdoor units from capacity table at the 100\% connection ratio} \times \text{Correction ratio of piping to furthest indoor}$$

Condition: Indoor connection ratio exceeds 100%.

$$\text{Maximum capacity of outdoor units} = \text{Capacity of outdoor units from capacity table at installed connection ratio} \times \text{Correction ratio of piping to furthest indoor}$$

- When level difference is 50 m or more (see installation manual and 3D079540 / 3D079543) and equivalent pipe length is 90 m or more, the diameter of the main gas and liquid pipes (outdoor unit - branch sections) must be increased. For new diameters, see below.

| Model | Gas | Liquid |
|-------|------|--------|
| 52 HP | 41.3 | 22.2 |

- When the pipe length after the first refrigerant branch kit is more than 40 m, pipe size between first and final branch kit must be increased (only for VRV DX indoor units; details see installation manual).

*Refer to the installation manual for allowed system setups and rules for dedicated indoor connection types.

Diameter of main pipes (standard size)

| Model | Gas | Liquid |
|-------|------|--------|
| 52 HP | 41.3 | 19.1 |

- Equivalent length used in the above figures is based upon the following equivalent length

$$\text{Equivalent piping length} = \text{Equivalent length of main pipe} \times \text{Correction factor} + \text{Equivalent length of branch pipes}$$

Choose a correction factor from the following table. When cooling capacity is calculated: gas pipe size When heating capacity is calculated: liquid pipe size

| | Correction factor | |
|-----------------------|-------------------|---------------|
| | Standard size | Size increase |
| Cooling (gas pipe) | 1.0 | 0.5 |
| Heating (liquid pipe) | 1.0 | 0.5 |

Example

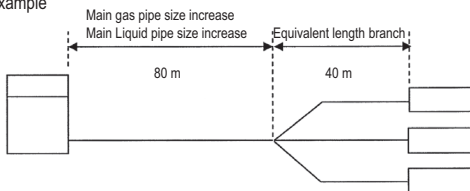

In the above case (Cooling) Overall equivalent length = 80 m x 1.0 + 40 m = 120 m
(Heating) Overall equivalent length = 80 m x 0.5 + 40 m = 80 m
The rate of change in cooling capacity when height difference = 0 is thus approximately 0.83
heating capacity when height difference = 0 is thus approximately 0.88

5 Capacity tables

5 - 2 Capacity Correction Factor

5

RYYQ54U, RXYQQ54U,
RXYQ54U

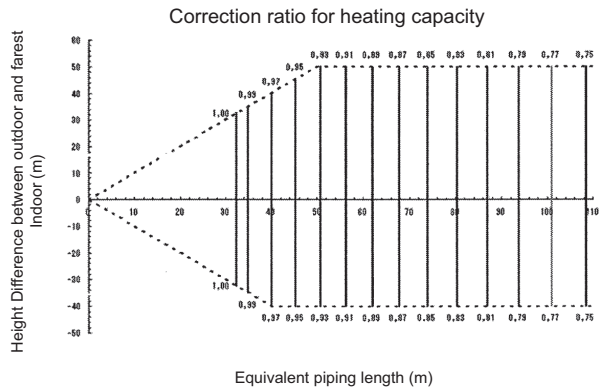
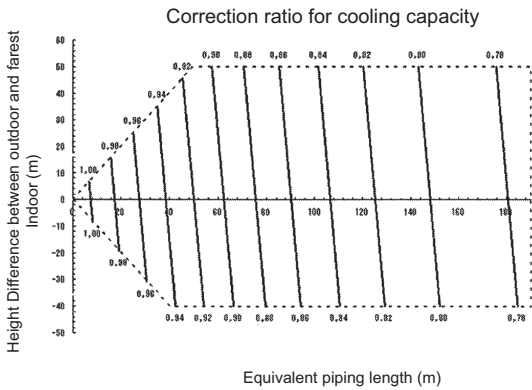

3D079897A

NOTES

- These figures illustrate the correction ratio for piping length in capacity for a standard indoor unit system at maximum load (with the thermostat set to maximum) under standard conditions. Moreover, under partial load conditions, there is only a minor deviation for the capacity correction ratio, shown in the above figures.
- With this outdoor unit, constant evaporating pressure control when cooling and constant condensing pressure control when heating is carried out.
- Method of calculating the capacity of the outdoor units
The maximum capacity of the system will be either the total capacity of the indoor units or the maximum capacity of the outdoor units as mentioned below, whichever is smaller.

Condition: Indoor connection ratio does not exceed 100%.

$$\text{Maximum capacity of outdoor units} = \text{Capacity of outdoor units from capacity table at the 100\% connection ratio} \times \text{Correction ratio of piping to furthest indoor}$$

Condition: Indoor connection ratio exceeds 100%.

$$\text{Maximum capacity of outdoor units} = \text{Capacity of outdoor units from capacity table at installed connection ratio} \times \text{Correction ratio of piping to furthest indoor}$$

- When level difference is 50 m or more (see installation manual and 3D079540 / 3D079543) and equivalent pipe length is 90 m or more, the diameter of the main gas and liquid pipes (outdoor unit - branch sections) must be increased. For new diameters, see below.

| Model | Gas | Liquid |
|-------|------|--------|
| 54 HP | 41.3 | 22.2 |

- When the pipe length after the first refrigerant branch kit is more than 40 m, pipe size between first and final branch kit must be increased (only for VRV DX indoor units; details see installation manual).
*Refer to the installation manual for allowed system setups and rules for dedicated indoor connection types.

Diameter of main pipes (standard size)

| Model | Gas | Liquid |
|-------|------|--------|
| 54 HP | 41.3 | 19.1 |

- Equivalent length used in the above figures is based upon the following equivalent length

$$\text{Equivalent piping length} = \text{Equivalent length of main pipe} \times \text{Correction factor} + \text{Equivalent length of branch pipes}$$

Choose a correction factor from the following table. When cooling capacity is calculated: gas pipe size When heating capacity is calculated: liquid pipe size

| | Correction factor | |
|-----------------------|-------------------|---------------|
| | Standard size | Size increase |
| Cooling (gas pipe) | 1.0 | 0.5 |
| Heating (liquid pipe) | 1.0 | 0.5 |

Example

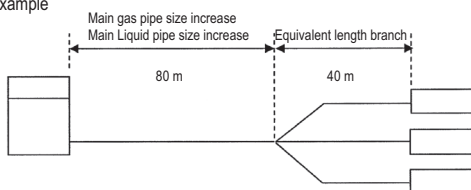

In the above case (Cooling) Overall equivalent length = 80 m x 1.0 + 40 m = 120 m
(Heating) Overall equivalent length = 80 m x 0.5 + 40 m = 80 m

The rate of change in cooling capacity when height difference = 0 is thus approximately 0.83
heating capacity when height difference = 0 is thus approximately 0.83

6 Dimensional drawings

6 - 1 Dimensional Drawings

REMQ5U
REYQ8-12U
RXYQQ8-12U
RXYQ8-12U
RYMQ8-12U
RXYTQ8-UYF

Notes

- Detail 'A' and detail 'B' indicate the dimensions after fixing the attached piping.
- Items 4 - 10: Knockout hole.
- Gas pipe
 - RYYQ8U, RYM08U, RXYQ8U, RXYQ08U, RXYTQ8U : \varnothing 19.1- brazing connection
 - RYYQ10U, RYM10U, RXYQ10U, RXYTQ10U : \varnothing 22.2- brazing connection
 - REMQ5U, REYQ8-12U : \varnothing 25.4- brazing connection
 - RYYQ12U, RYM12U, RXYQ12U, RXYTQ12U : \varnothing 28.6- brazing connection
 - Liquid pipe
 - RXYQ8-10U, RYM08-10U, RXYQ8-10U, RXYQ08-10U, : \varnothing 9.5- brazing connection
 - REMQ5U, REYQ8-12U, RXYTQ8U
 - RYYQ12U, RYM12U, RXYQ12U, RXYTQ12U : \varnothing 12.7- brazing connection
- Equalising pipe
 - RYMQ8-10U : \varnothing 19.1- brazing connection
 - RYMQ12U : \varnothing 22.2- brazing connection
- High pressure/low pressure gas pipe
 - REMQ5U, REYQ8-12U : \varnothing 19.1- brazing connection

| Model | AA | AB |
|---|-----|-----|
| RYYQ8-12U, RXYQ8-12U, RXYQ08-12U, RXYTQ8U | - | - |
| REMQ5U, RYM08-12U, REYQ8-12U | 246 | 240 |

| | | |
|-----|-------------------------------------|---------------------------------|
| 11 | Grounding terminal | |
| 10 | Pipe routing hole (bottom) | |
| 9 | Pipe routing hole (front) | Inside of the switch box (-M8-) |
| 8 | Power cord routing hole (bottom) | 065 |
| 7 | Power cord routing hole (front) | 027 |
| 6 | Power cord routing hole (front) | 065 |
| 5 | Power cord routing hole (front) | 080 |
| 4 | Power cord routing hole (side) | 065 |
| 3 | Equalising pipe connection port | See note -3- |
| | High pressure/low pressure gas pipe | See note -3- |
| 2 | Gas pipe connection port | See note -3- |
| 1 | Liquid pipe connection port | Remark |
| No. | Part name | |

2D119001

REYQ14-20U
RXYQQ14-20U
RXYTQ10-16U
RYYQ14-20U
RYMQ14-20U

Notes

- Detail A and detail B indicate the dimensions after fixing the attached piping.
- Items 4 - 10: Knockout hole.
- Gas pipe
 - RXYTQ10U : \varnothing 22.2 brazing connection
 - REYQ14-20U : \varnothing 25.4 brazing connection
 - RYYQ14-20U, RYM14-20U, RXYQ14-20U, RXYQ14-20U, RXYTQ12-16U Liquid pipe : \varnothing 28.6 brazing connection
 - RXYTQ10U : \varnothing 9.5 brazing connection
 - RYYQ14-16U, RYM14-16U, RXYQ14-16U, RXYQ14-16U, REYQ14-20U, RXYTQ12-16U : \varnothing 12.7 brazing connection
 - RYYQ18-20U, RYM18-20U, RXYQ18-20U, RXYQ18-20U Equalising pipe : \varnothing 15.9 brazing connection
 - RYMQ14-16U : \varnothing 22.2 brazing connection
 - RYMQ18-20U : \varnothing 28.6 brazing connection
 - High pressure/low pressure gas pipe : \varnothing 19.1- brazing connection
 - REYQ14-20U : \varnothing 22.2 brazing connection

| Model | AA | AB |
|---|-----|-----|
| RXYQ14-20U, RYYQ14-20U, RXYQ14-20U, RXYTQ10-16U | - | - |
| RYMQ14-16U, REYQ14-20U | 240 | 155 |
| RYMQ18-20U | 240 | 192 |

| | | |
|-----|-------------------------------------|-------------------------------|
| 11 | Grounding terminal | |
| 10 | Pipe routing hole (bottom) | |
| 9 | Pipe routing hole (front) | Inside of the switch box (M8) |
| 8 | Power cord routing hole (bottom) | 065 |
| 7 | Power cord routing hole (front) | 027 |
| 6 | Power cord routing hole (front) | 065 |
| 5 | Power cord routing hole (front) | 080 |
| 4 | Power cord routing hole (side) | 065 |
| 3 | Equalising pipe connection port | See note 3. |
| | High pressure/low pressure gas pipe | See note 3. |
| 2 | Gas pipe connection port | See note 3. |
| 1 | Liquid pipe connection port | See note 3. |
| No. | Part name | Remark |

2D119091

7 Centre of gravity

7 - 1 Centre of Gravity

7

RXYQQ8-12U
 RXYQ8-12U
 RXYTQ8U
 RYYQ8-12U
 RYMQ8-12U

| Unit | AA | AB | AC |
|--------------------|-----|-----|-----|
| RYYQ8-12U | 328 | 366 | 565 |
| REMQ5U / REYQ8-12U | | | |
| RYMQ8-12U | 354 | 443 | 565 |
| RXYQ8-12U | 339 | 448 | 565 |
| RXYQQ8-12U | | | |
| RXYTQ8U | | | |

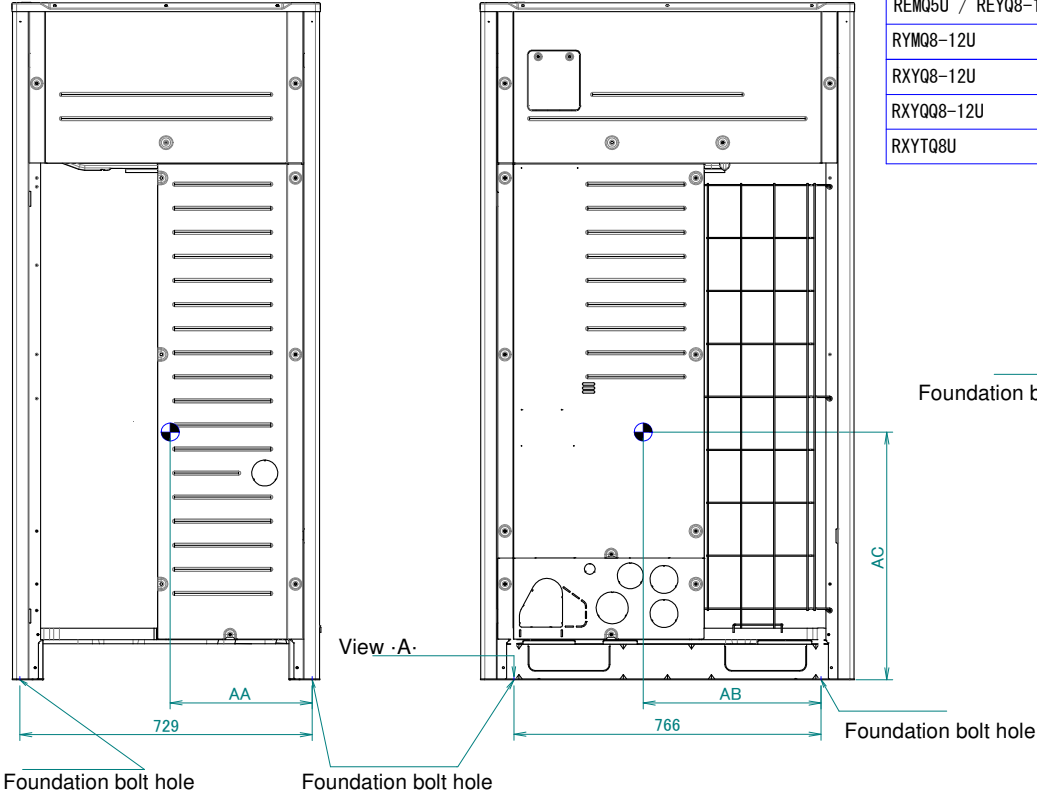

3D119703

RXYQQ14-20U
 RXYQ14-20U
 RXYTQ10-16U
 RYYQ14-20U
 RYMQ14-20U

| Unit | AA | AB | AC |
|----------------|-----|-----|-----|
| RYYQ14-20U | 334 | 470 | 610 |
| REYQ14-20U | 334 | 470 | 610 |
| RYMQ14-20U | 360 | 569 | 610 |
| RXYQ(Q) 14-20U | 345 | 575 | 610 |
| RXYTQ10-12U | 350 | 610 | 810 |
| RXYTQ14-16U | 351 | 565 | 610 |

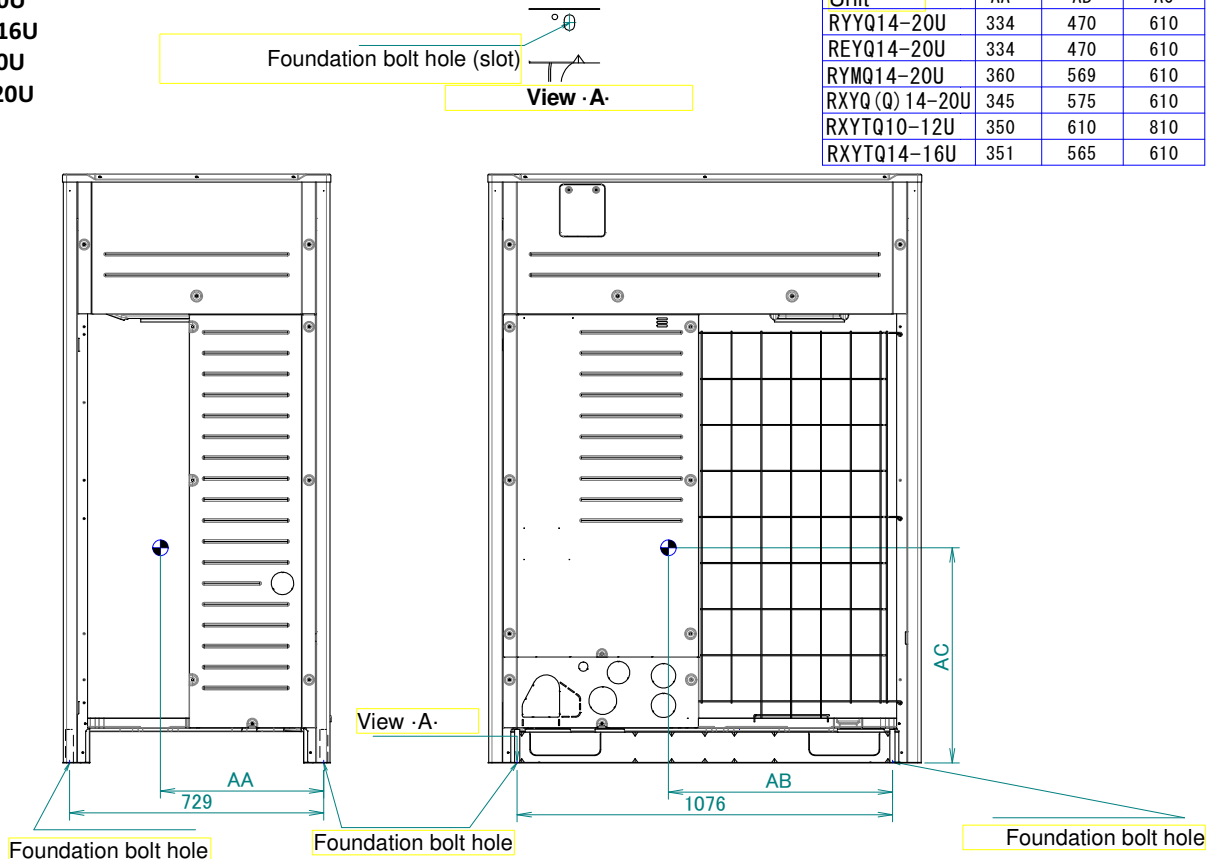

3D119704

8 Piping diagrams

8 - 1 Piping Diagrams

RXYQ8-12U RXYTQ8UYF

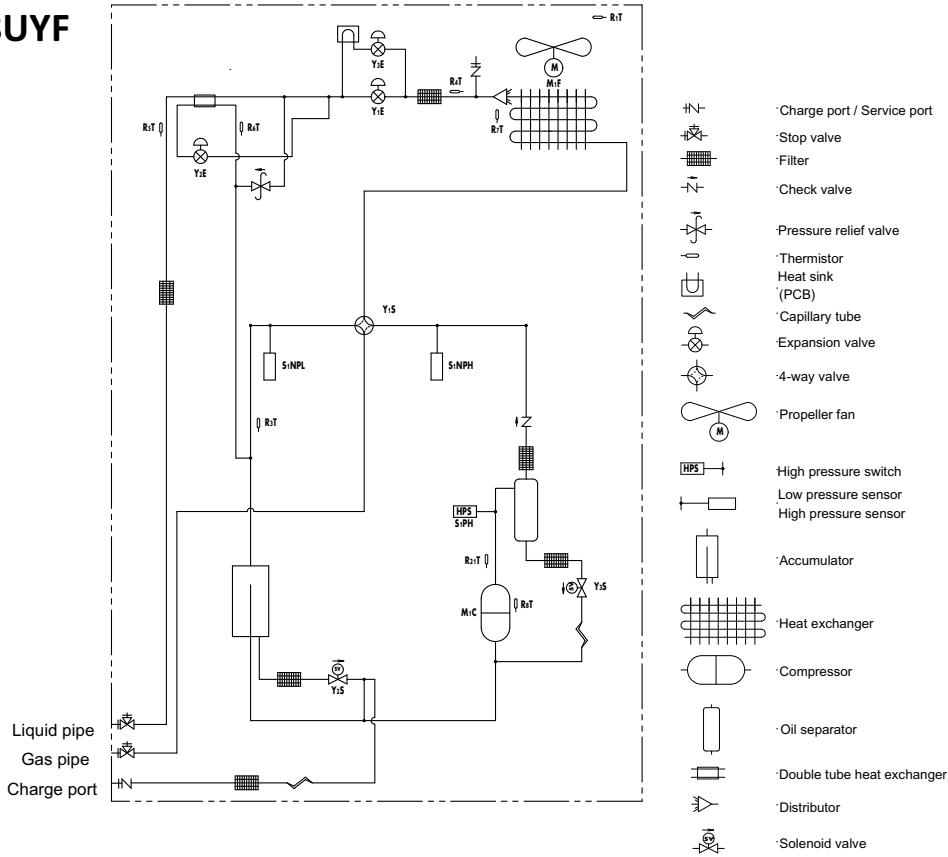

3D118179

RXYQ14-20U RXYQ14-16UYF

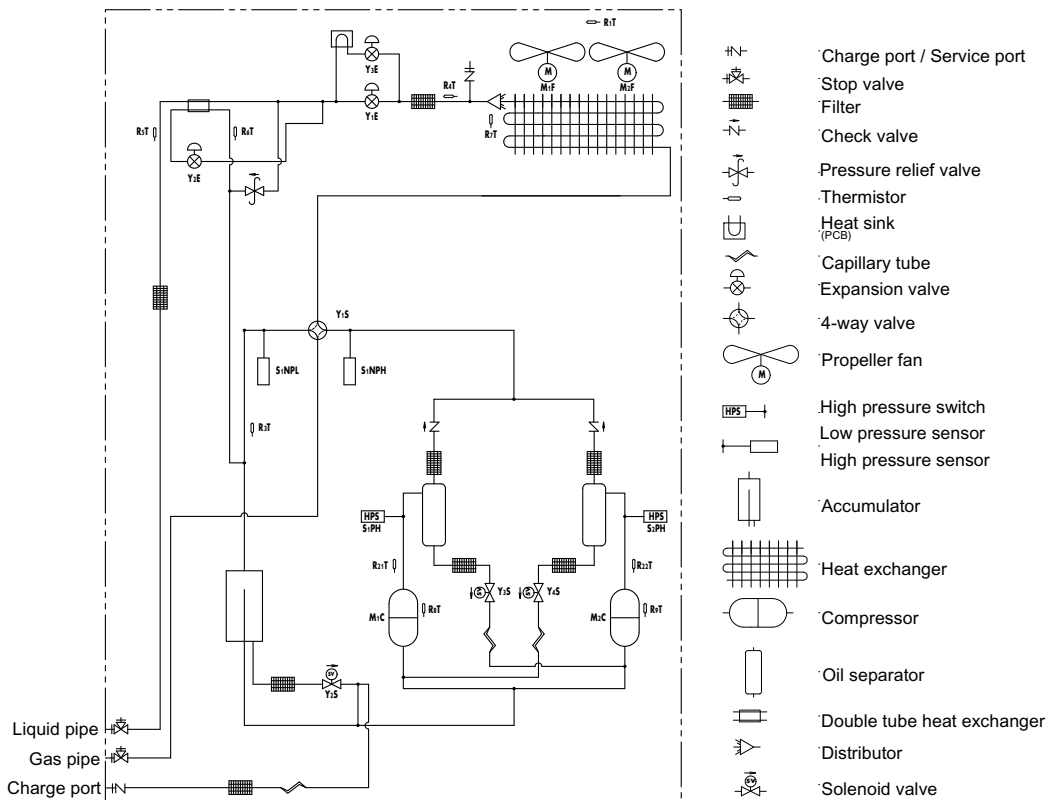

3D118180

9 Wiring diagrams

9 - 1 Wiring Diagrams - Single Phase

9

RXYQ8-12U
 RXYTQ8UYF
 RYYQ8-12U
 RYMQ8-12U

Power supply 3N~ 380-415V 50Hz
 3N~ 380V 60Hz

Wiring diagram

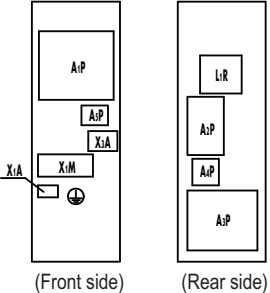
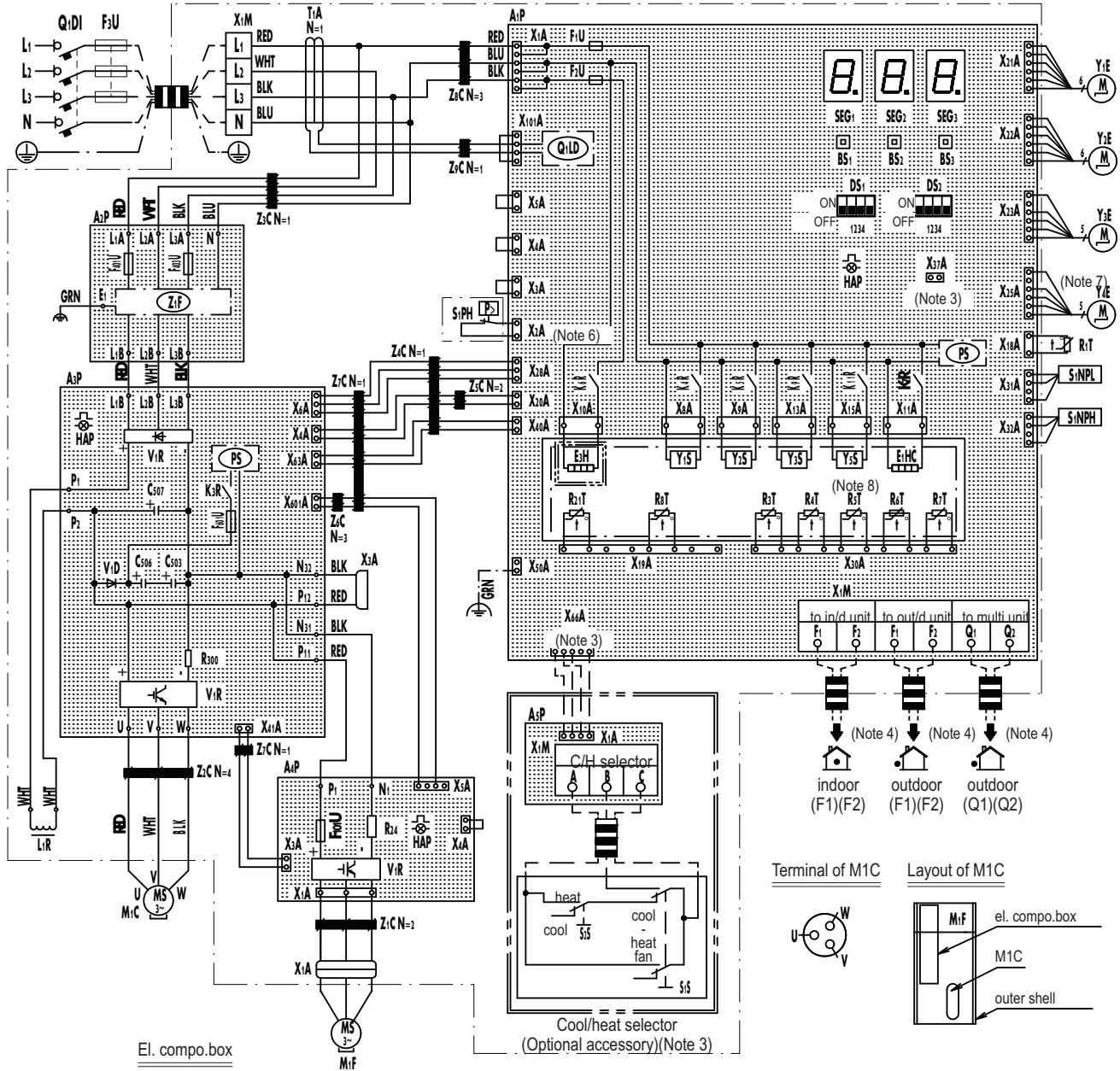

8,10,12 class

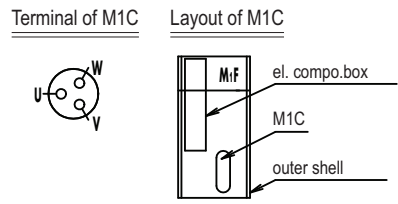

9 Wiring diagrams

9 - 1 Wiring Diagrams - Single Phase

RXYQ8-12U
RXYTQ8UYF
RYYQ8-12U
RYMQ8-12U

| | | | |
|----------------------|---|------------------------------------|---|
| A1P | Printed Circuit Board (Main) | R3T | Thermistor (Accumulator) |
| A2P | Printed Circuit Board (Noise Filter) | R4T | Thermistor (Heat Exc,Liq,Pipe) |
| A3P | Printed Circuit Board (Inv) | R5T | Thermistor (Subcool,Liq,Pipe) |
| A4P | Printed Circuit Board (Fan) | R6T | Thermistor (Heat Exc,Gas Pipe) |
| A5P | Printed Circuit Board (ABC I/P)(Option) | R7T | Thermistor (Heat Exc,Deicer) |
| BS1~3 (A1P) | Push Button Switch (Mode,Set,Return) | R8T | Thermistor (M1C body) |
| C503,C506,C507 (A3P) | Capacitor | R21T | Thermistor (M1C discharge) |
| DS1,DS2 (A1P) | DIP Switch | S1NPH | Pressure Sensor (High) |
| E1HC | Crankcase Heater | S1NPL | Pressure Sensor (Low) |
| E3H | Drainpan Heater (Option) | S1PH | Pressure Switch (Disch) |
| F1U,F2U (A1P) | Fuse (T,3,15A,250V) | SEG1~SEG3 (A1P) | 7-Segment Display |
| F3U | Field Fuse | T1A | Current Sensor |
| F101U (A4P) | Fuse | V1D (A3P) | Diode |
| F401U,F403U (A2P) | Fuse | V1R (A3P,A4P) | Power Module |
| F601U (A3P) | Fuse | X*A | Connector |
| HAP (A1P,A3P, A4P) | Pilotlamp (Service Monitor-Green) | X1M (A1P) | Terminal Block (Control) |
| K3R (A3P) | Magnetic Relay | X1M (A5P) | Terminal Block (Power Supply)(Option) |
| K4R (A1P) | Magnetic Relay (Y1S) | Y1E | Electronic Expansion Valve(Main) |
| K5R (A1P) | Magnetic Relay (Y2S) | Y2E | Electronic Expansion Valve (Injection) |
| K6R (A1P) | Magnetic Relay (E3H) | Y3E | Electronic Expansion Valve (Refrigerant Jacket) |
| K7R (A1P) | Magnetic Relay (E1HC) | Y4E | Electronic Expansion Valve (Storage Vessel) |
| K9R (A1P) | Magnetic Relay (Y3S) | Y1S | Solenoid Valve (Main) |
| K11R (A1P) | Magnetic Relay (Y5S) | Y2S | Solenoid Valve (Accumulator Oil Return) |
| L1R | Reactor | Y3S | Solenoid Valve (Oil1) |
| M1C | Motor (Compressor) | Y5S | Solenoid Valve (Sub) |
| M1F | Motor (Fan) | Z*C | Noise Filter (Ferrite Core) |
| PS (A1P,A3P) | Switching Power Supply | Z*F (A2P) | Noise Filter (With Surge Absorber) |
| Q1DI | Field Earth Leakage Breaker | Connector For Optional Accessories | |
| Q1LD (A1P) | Field Earth Current Detector | X10A | Connector (Drainpan Heater) |
| R24 (A4P) | Resistor (Current Sensor) | X37A | Connector (Power Adapter) |
| R300 (A3P) | Resistor (Current Sensor) | X66A | Connector (Remote Switching Cool/Heat Selector) |
| R1T | Thermistor (Air) | | |

NOTES

1. This wiring diagram applies only to the outdoor unit.
2. :field wiring, :terminal block, :connector, :terminal, : protective earth (screw), : functional earth, : earth wiring, : field supply, : PCB, : switch box, : option
3. When using the optional adapter, refer to the installation manual of the optional adapter.
4. For connection wiring to indoor-outdoor transmission F1-F2, outdoor-outdoor transmission F1-F2, outdoor-multi transmission Q1-Q2, refer to the installation manual.
5. How to use BS1~3 switch. Refer to "service precaution" label on el. compo. box cover.
6. When operating, don't shortcircuit the protection devices (S1PH).
7. Only for RYYQ model.
8. Only for RYYQ/RYMQ model.
9. Colors: BLK: Black, RED: Red, BLU: Blue, WHT: White, GRN: Green.

2D117534

9 Wiring diagrams

9 - 1 Wiring Diagrams - Single Phase

9

RXYQ14-20U
 RXYTQ14-16U
 RYYQ14-20U
 RYMQ14-20U

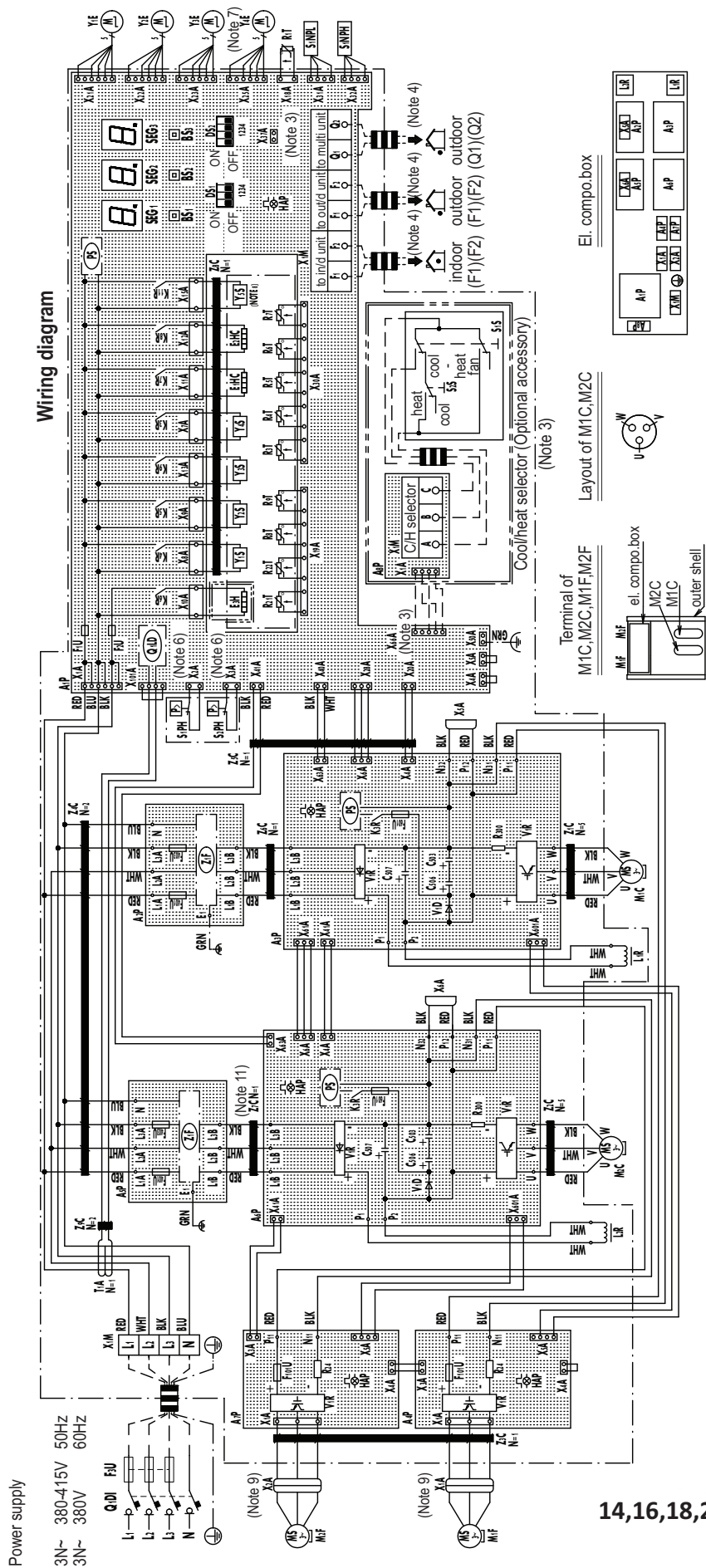

9 Wiring diagrams

9 - 1 Wiring Diagrams - Single Phase

RXYQ14-20U
RXYTQ14-16U
RYYQ14-20U
RYMQ14-20U

| | | | |
|---------------------------|--------------------------------------|------------------------------------|--|
| A1P | Printed Circuit Board (Main) | R3T | Thermistor (Accumulator) |
| A2P,A5P | Printed Circuit Board (Noise Filter) | R4T | Thermistor (Heat Exc,Liq,Pipe) |
| A3P,A6P | Printed Circuit Board (Inv) | R5T | Thermistor (Subcool,Liq,Pipe) |
| A4P,A7P | Printed Circuit Board (Fan) | R6T | Thermistor (Heat Exc,Gas Pipe) |
| A8P | Printed Circuit Board (ABC I/P) | R7T | Thermistor (Heat Exc,Deicer) |
| C503,C506,C507 (A3P,A6P) | Capacitor | R8T,R9T | Thermistor (M1C ,M2C body) |
| DS1,DS2 (A1P) | DIP Switch | R21T,R22T | Thermistor (M1C ,M2C discharge) |
| E1HC,E2HC | Crankcase Heater | S1NPH | Pressure Sensor (High) |
| E3H | Drainpan Heater (Option) | S1NPL | Pressure Sensor (Low) |
| F1U,F2U (A1P) | Fuse (T,3,15A,250V) | S1PH,S2PH | Pressure Switch (Disch) |
| F3U | Field Fuse | SEG1~SEG3 (A1P) | 7-Segment Display |
| F101U (A4P,A7P) | Fuse | T1A | Current Sensor |
| F401U,F403U (A2P,A5P) | Fuse | V1D (A3P,A6P) | Diode |
| F601U (A3P,A6P) | Fuse | V1R (A3P,A4P,A6P,A7P) | Power Module |
| HAP (A1P,A3P,A4P,A6P,A7P) | Pilotlamp (Service Monitor-Green) | X*A | Connector |
| K3R (A3P,A6P) | Magnetic Relay | X1M (A1P) | Terminal Block (Control) |
| K3R (A1P) | Magnetic Relay (Y4S) | X1M (A8P) | Terminal Block (Power Supply) |
| K4R (A1P) | Magnetic Relay (Y1S) | Y1E | Electronic Expansion Valve(Main) |
| K5R (A1P) | Magnetic Relay (Y2S) | Y2E | Electronic Expansion Valve (Injection) |
| K6R (A1P) | Magnetic Relay (E3H) | Y3E | Electronic Expansion Valve (Refrigerant Jacket) |
| K7R (A1P) | Magnetic Relay (E1HC) | Y4E | Electronic Expansion Valve (Storage Vessel) (Note 7) |
| K8R (A1P) | Magnetic Relay (E2HC) | Y1S | Solenoid Valve (Main) |
| K9R (A1P) | Magnetic Relay (Y3S) | Y2S | Solenoid Valve (Accumulator Oil Return) |
| K11R (A1P) | Magnetic Relay (Y5S) | Y3S | Solenoid Valve (Oil1) |
| L1R,L2R | Reactor | Y3S | Solenoid Valve (Oil2) |
| M1C,M2C | Motor (Compressor) | Y5S | Solenoid Valve (Sub) (Note 8) |
| M1F,M2F | Motor (Fan) | Z*C | Noise Filter (Ferrite Core) |
| PS (A1P,A3P,A6P) | Switching Power Supply | Z*F (A2P,A5P) | Noise Filter (With Surge Absorber) |
| Q1DI | Field Earth Leakage Breaker | Connector For Optional Accessories | |
| Q1LD (A1P) | Field Earth Current Detector | X10A | Connector (Drainpan Heater) |
| R24 (A4P,A7P) | Resistor (Current Sensor) | X37A | Connector (Power Adapter) |
| R300 (A3P,A6P) | Resistor (Current Sensor) | X66A | Connector (Remote Switching Cool/Heat Selector) |
| R1T | Thermistor (Air) | | |

NOTES

1. This wiring diagram applies only to the outdoor unit.
2. :field wiring, : terminal block, : connector, : terminal, : protective earth (screw), : functional earth, : earth wiring, : field supply, : PCB, : switch box, : option
3. When using the optional adapter, refer to the installation manual of the optional adapter.
4. For connection wiring to indoor-outdoor transmission F1-F2, outdoor-outdoor transmission F1-F2, outdoor-multi transmission Q1-Q2, refer to the installation manual.
5. How to use BS1~3 switch. Refer to "service precaution" label on el. compo. box cover.
6. When operating, don't shortcircuit the protection devices (S1PH, S2PH).
7. Only for RYYQ model.
8. Only for RYYQ/RYMQ model.
9. Connector x1a (m1f) is red, connector x2a (m2f) is white.
10. Colors: BLK: Black, RED: Red, BLU: Blue, WHT: White, GRN: Green.
11. Only for 14,16 class

2D117536B

10 External connection diagrams

10 - 1 External Connection Diagrams

RXYQQ8-20U
 RXYQ8-20U
 RYYQ8-20U
 RYMQ8-20U
 RXYTQ8-16UYF

Notes

1. All wiring, components and materials to be procured on-site must comply with the applicable legislation.
2. Use copper conductors only
3. For details, refer to the wiring diagram attached to the outdoor unit.
4. Install a circuit breaker for safety.
5. All field wiring and components must be provided by an authorised electrician.
6. Unit has to be grounded in compliance with the applicable legislation.
7. The wiring shown is a general points-of-connection guide and is not intended to include all details for a specific installation.
8. Make sure to install the switch and the fuse to the power line of each equipment.
9. Install a main switch to control the multiple power sources that the various components of the system make use of.
10. If there exists the possibility of reversed phase, loose phase or momentary blackout, or if the power goes on and off while the product is operating, attach a reversed phase protection circuit locally.
- Running the product in reversed phase may break the compressor and other parts.
11. Install an earth leakage circuit breaker.

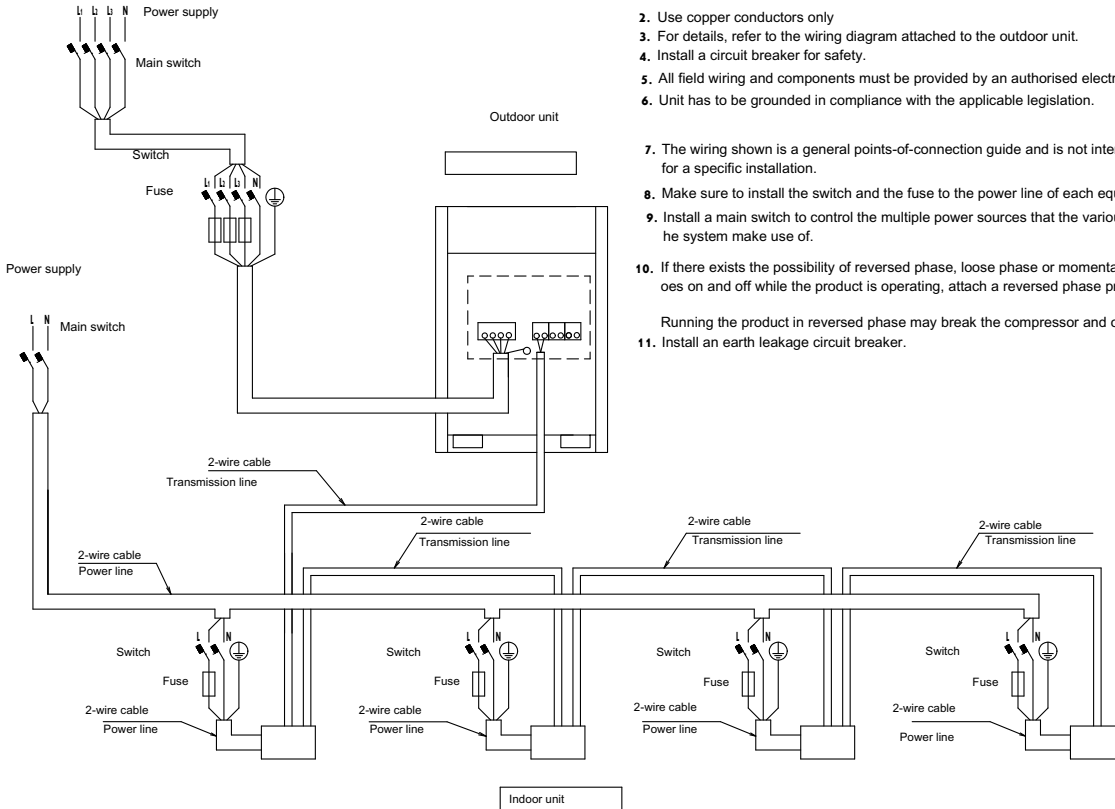

3D119317

RXYQQ8-20U
 RXYQ8-20U
 RXYTQ8-16U
 RYYQ8-20U
 RYMQ8-26U

Notes

1. All wiring, components and materials to be procured on-site must comply with the applicable legislation.
2. Use copper conductors only
3. For details, refer to the wiring diagram attached to the outdoor unit.
4. Install a circuit breaker for safety.
5. All field wiring and components must be provided by an authorised electrician.
6. Unit has to be grounded in compliance with the applicable legislation.
7. The wiring shown is a general points-of-connection guide and is not intended to include all details for a specific installation.
8. Make sure to install the switch and the fuse to the power line of each equipment.
9. Install a main switch to control the multiple power sources that the various components of the system make use of.
10. The capacity of UNIT1 must be larger than that of UNIT2 when the power source is connected in series between the units.
11. If there exists the possibility of reversed phase, loose phase or momentary blackout, or if the power goes on and off while the product is operating, attach a reversed phase protection circuit locally.
- Running the product in reversed phase may break the compressor and other parts.
12. Install an earth leakage circuit breaker.

< Power source is supplied to each outdoor unit individually. >

< Power source is connected in series between the units. >

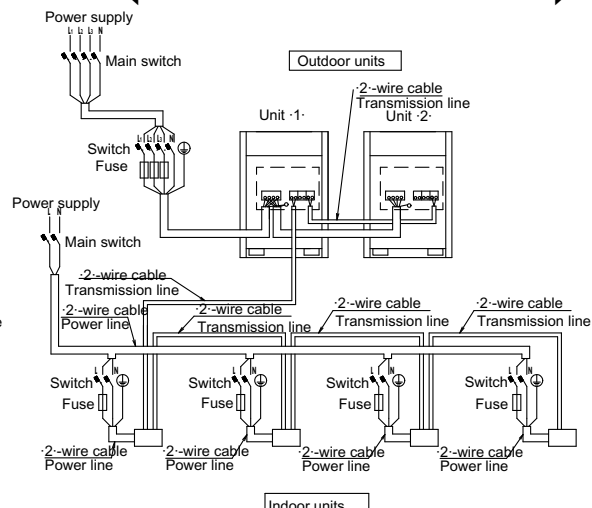
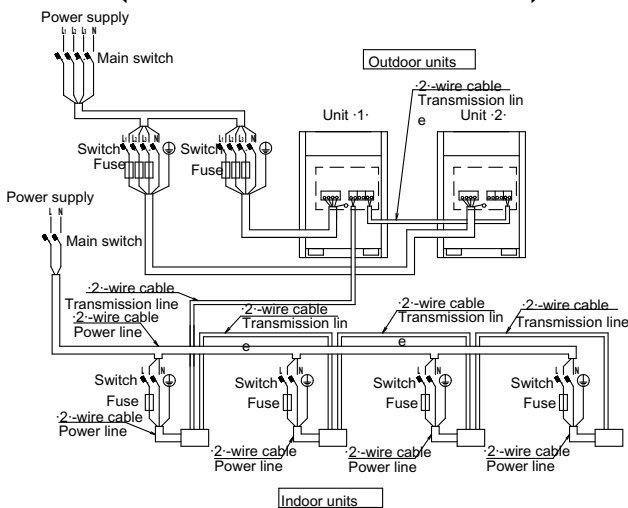

3D119316

10 External connection diagrams

10 - 1 External Connection Diagrams

RXYQ8-20U
 RXYQ8-20U
 RXYT8-16UYF
 RYYQ8-20U
 RYMQ8-20U
 RXYT8-16U

Notes

- All wiring, components and materials to be procured on-site must comply with the applicable legislation.
- Use copper conductors only
- For details, refer to the wiring diagram attached to the outdoor unit.
- Install a circuit breaker for safety.
- All field wiring and components must be provided by an authorised electrician.
- Unit has to be grounded in compliance with the applicable legislation.
- The wiring shown is a general points-of-connection guide and is not intended to include all details for a specific installation.
- Make sure to install the switch and the fuse to the power line of each equipment.
- Install a main switch to control the multiple power sources that the various components of the system make use of.
- The capacity of UNIT1 must be larger than that of UNIT2 when the power source is connected in series between the units.
 The capacity of UNIT 2 must be larger than that of UNIT3 when the power source is connected in series between the units.
- If there exists the possibility of reversed phase, loose phase or momentary blackout, or if the power goes on and off while the product is operating, attach a reversed phase protection circuit locally.
 Running the product in reversed phase may break the compressor and other parts.
- Install an earth leakage circuit breaker.

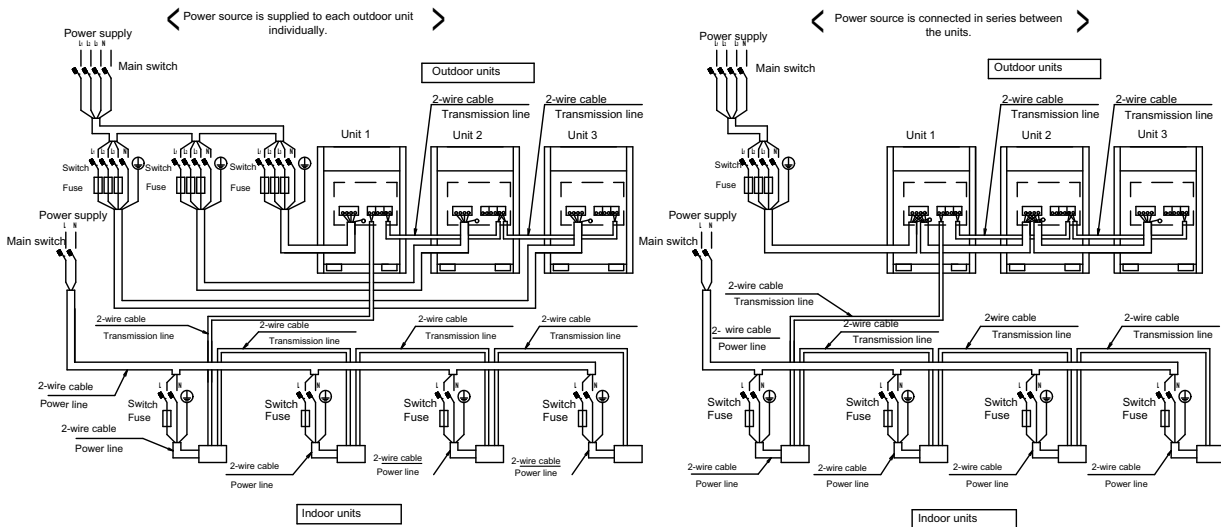

3D119200

11 Sound data

11 - 1 Sound Power Spectrum

11

REMQ5U
REYQ8U
RXYQQ8U
RXYQ8U
RXYTQ8UYF
RYYQ8U
RYMQ8U

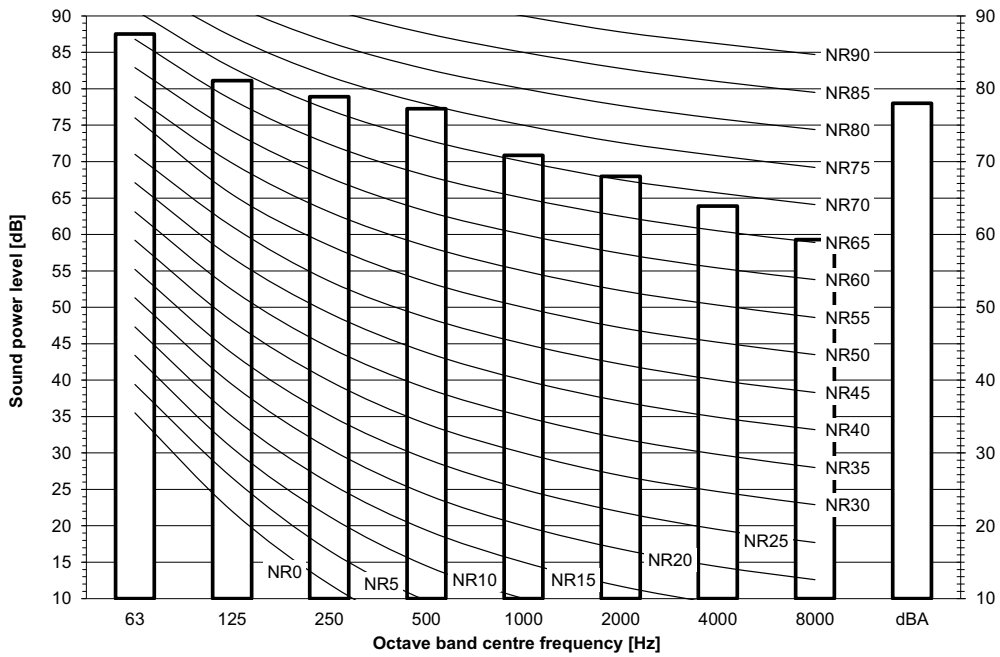

Notes
 dBA = A-weighted sound power level (A scale according to IEC).
 Reference acoustic intensity 0dB = 10E-6μW/m²
 Measured according to ISO 3744

3D119528

REYQ10U
RXYQQ10U
RXYQ10U
RYYQ10U
RYMQ10U

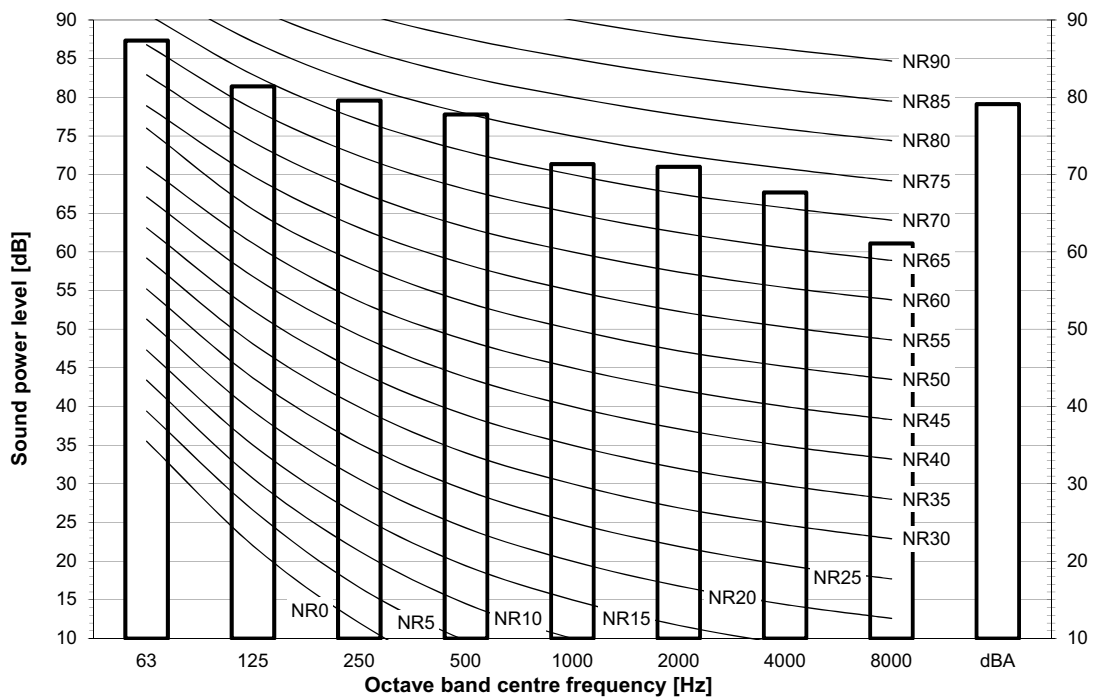

Notes
 dBA = A-weighted sound power level (A scale according to IEC).
 Reference acoustic intensity 0dB = 10E-6μW/m²
 Measured according to ISO 3744

3D119529

11 Sound data

11 - 1 Sound Power Spectrum

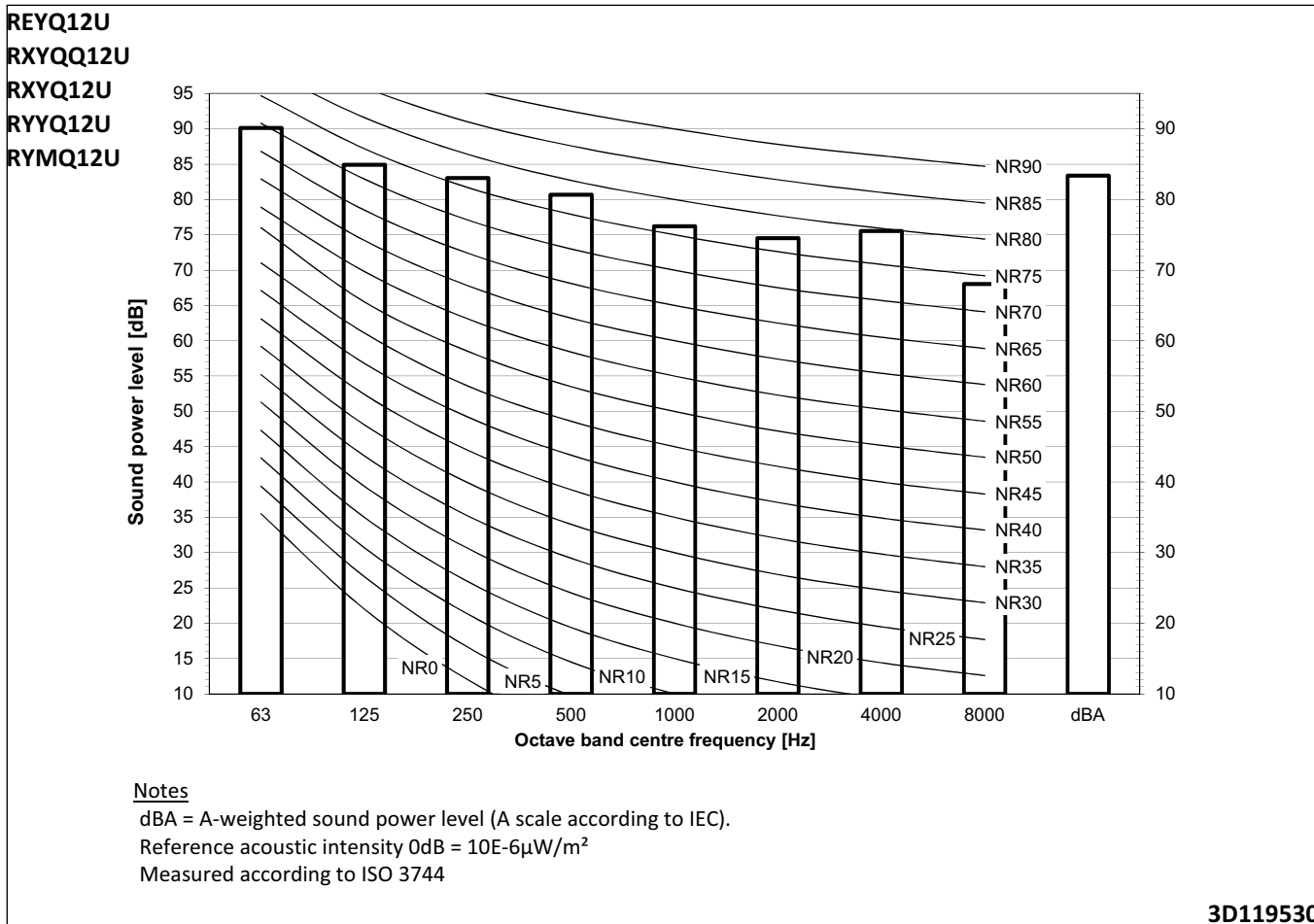

3D119530

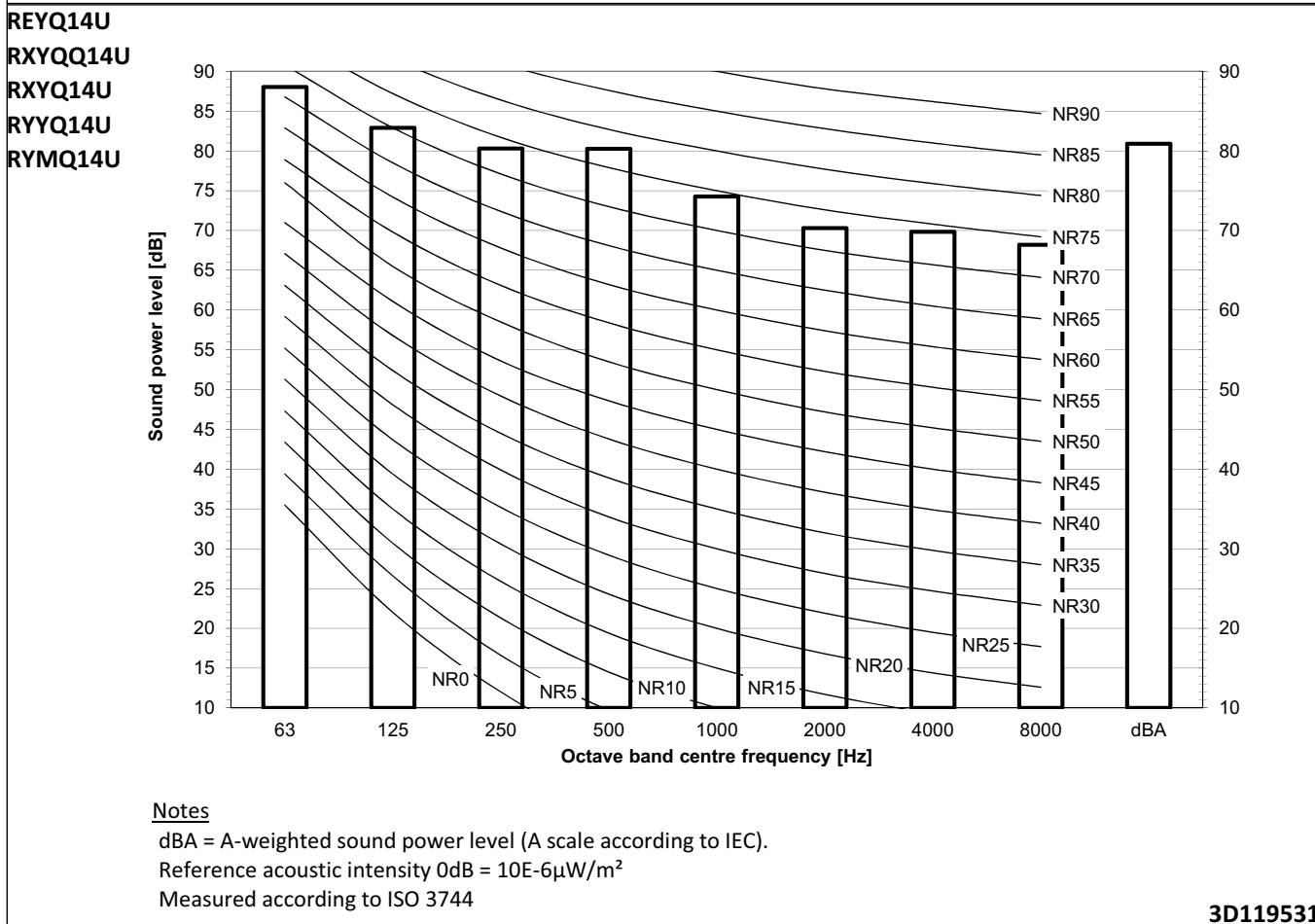

3D119531

11 Sound data

11 - 1 Sound Power Spectrum

11

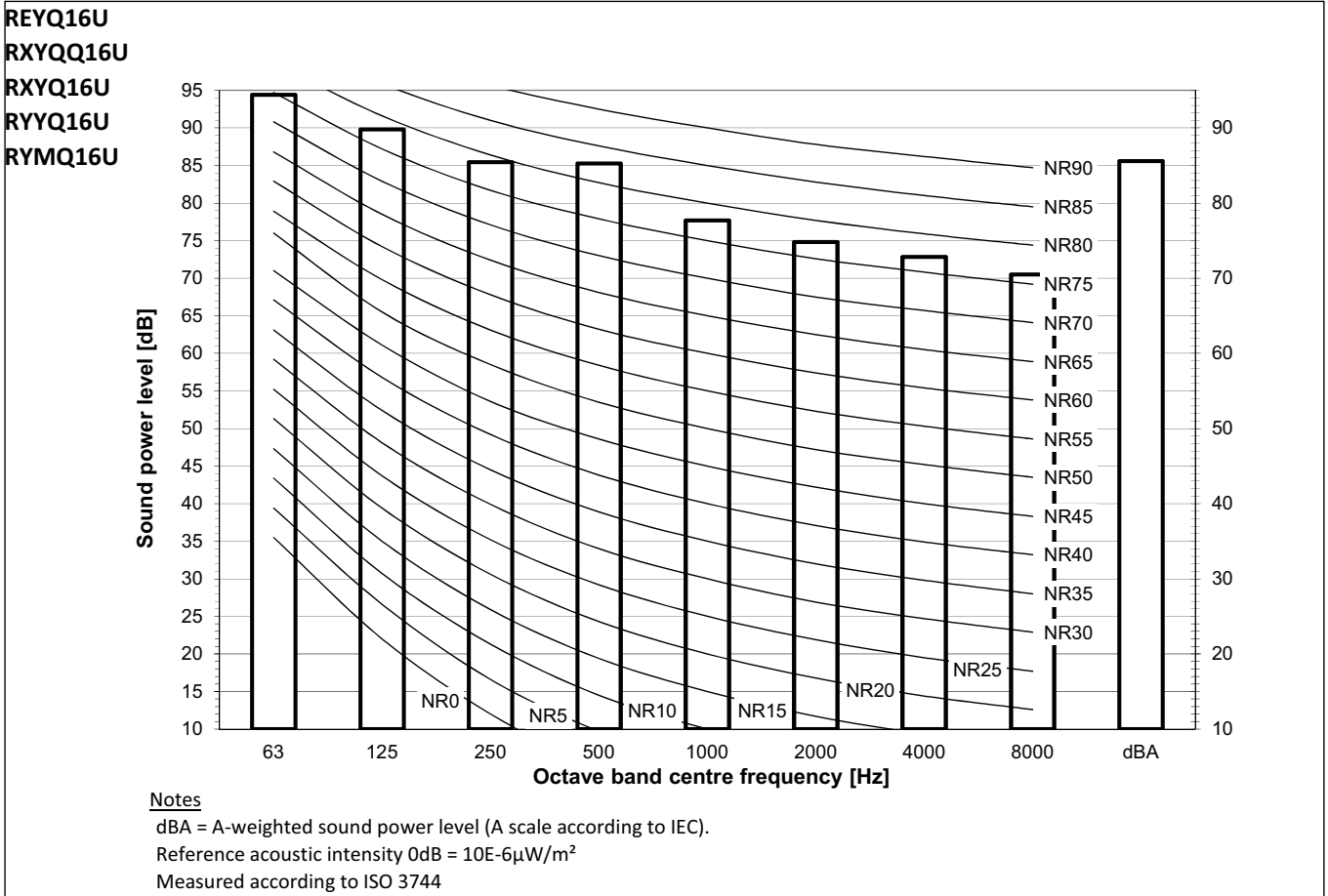

3D119532

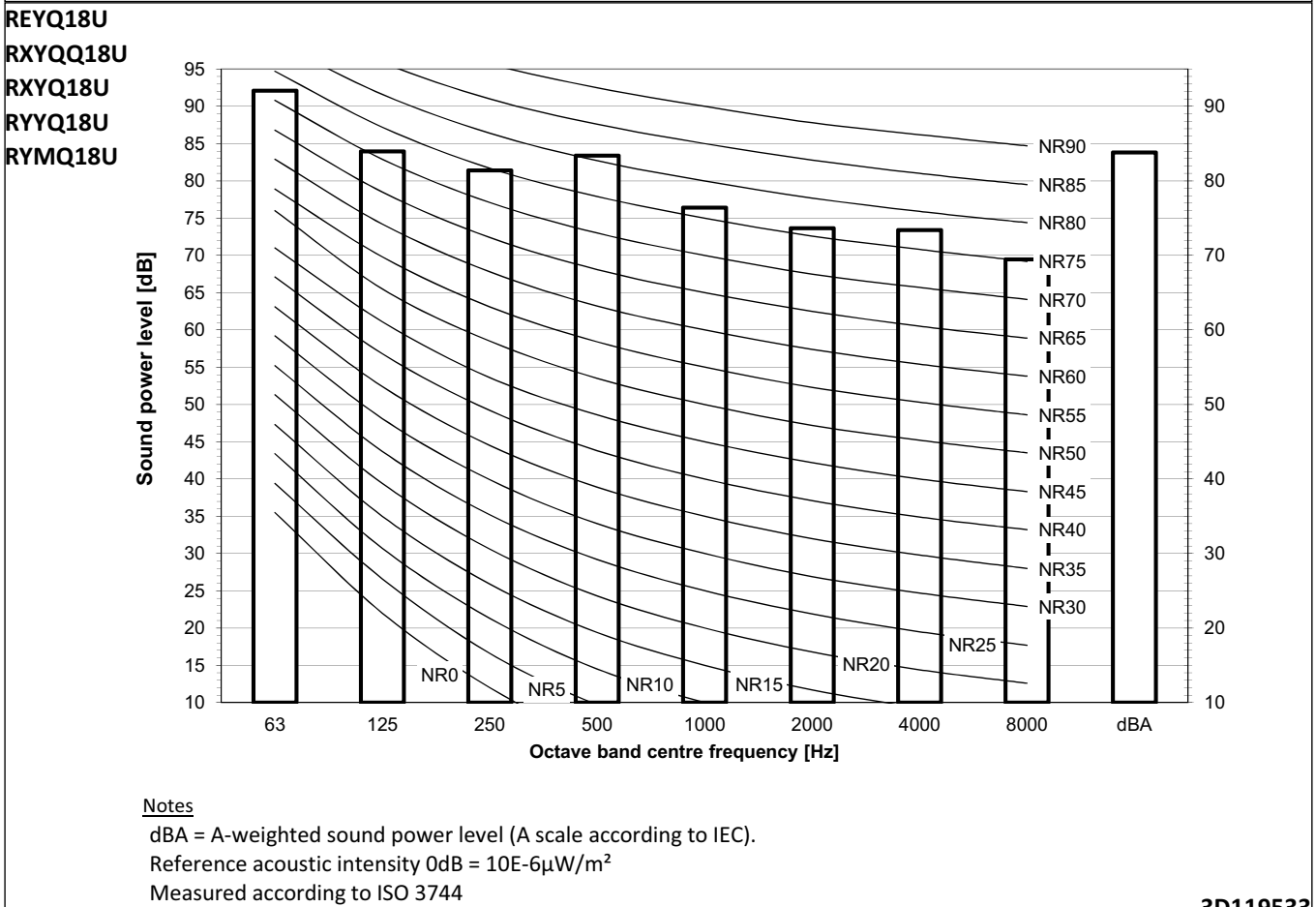

3D119533

11 Sound data

11 - 1 Sound Power Spectrum

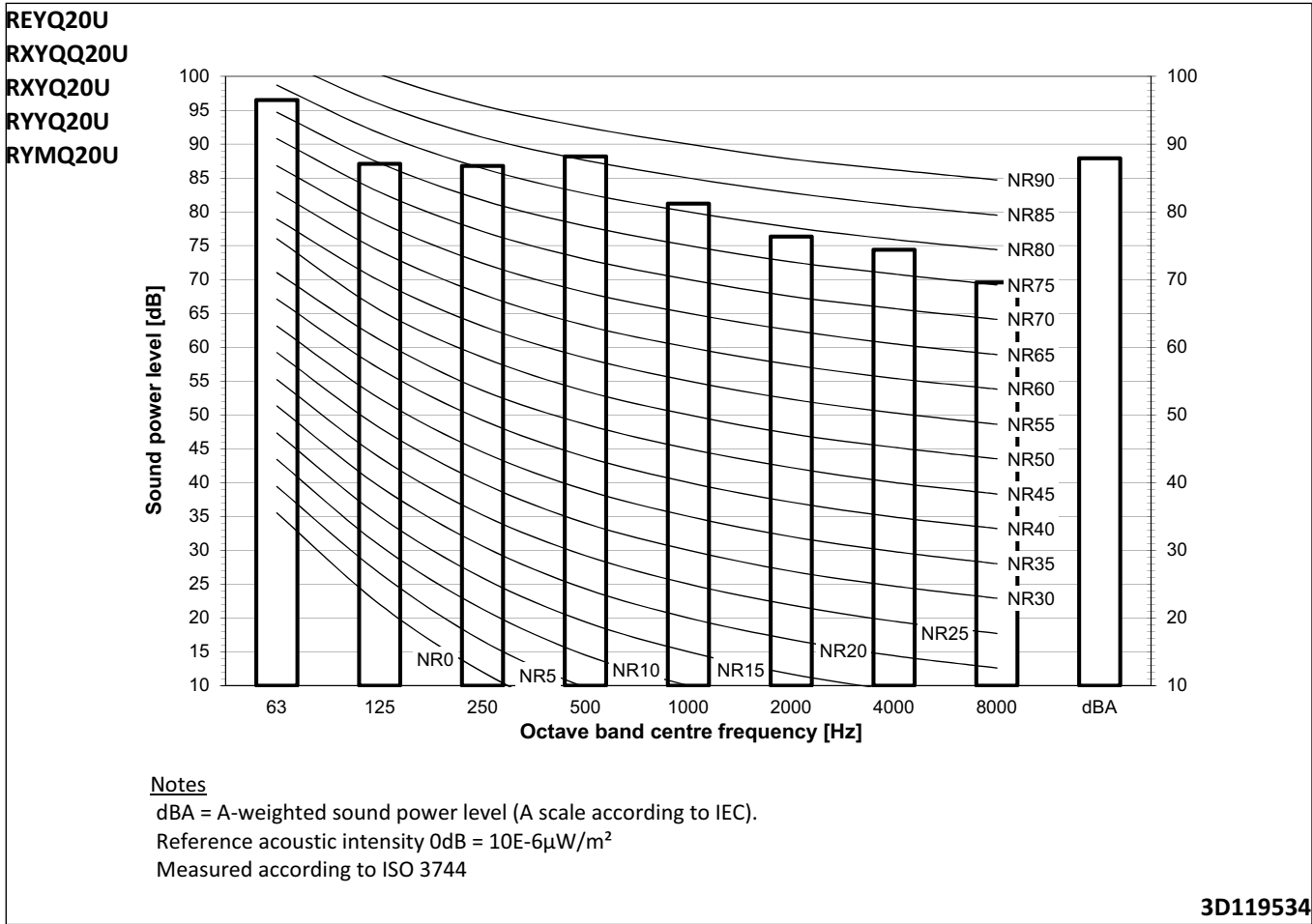

11 Sound data

11 - 2 Sound Pressure Spectrum

11

REMQ5U
REYQ8U
RXYQQ8U
RXYQ8U
RXYTQ8UYF
RYYQ8U
RYMQ8U

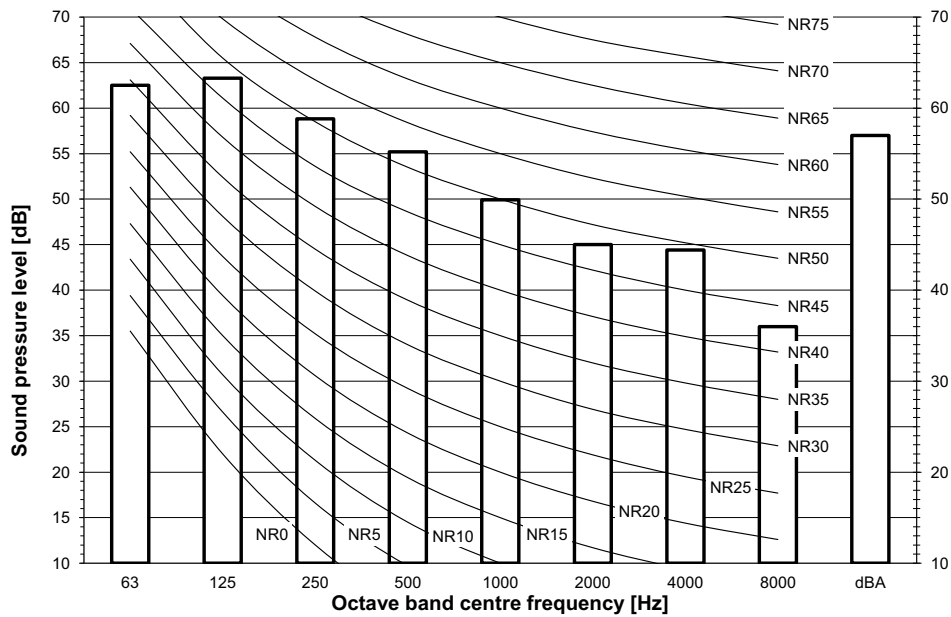

Notes

Data is valid at free field condition.
Data is valid at nominal operation condition.
dBA = A-weighted sound pressure level (A scale according to IEC).
Reference acoustic pressure 0 dB = 20 µPa

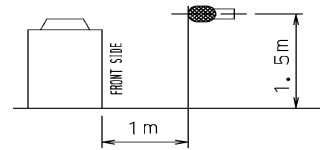

3D119521

REYQ10U
RXYQQ10U
RXYQ10U
RYYQ10U
RYMQ10U

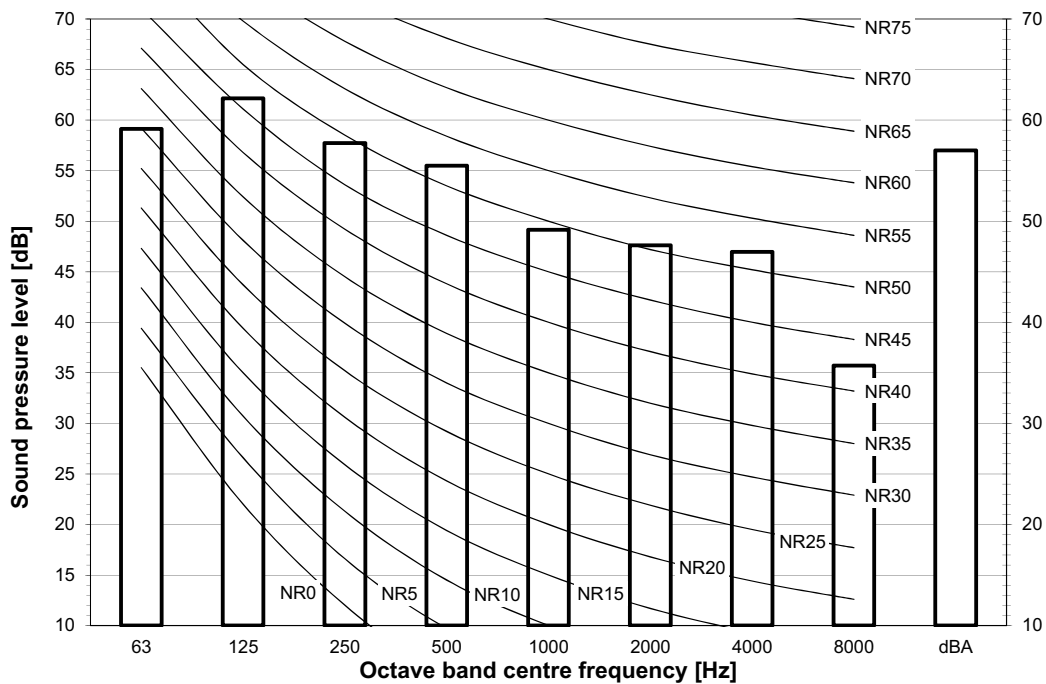

Notes

Data is valid at free field condition.
Data is valid at nominal operation condition.
dBA = A-weighted sound pressure level (A scale according to IEC).
Reference acoustic pressure 0 dB = 20 µPa

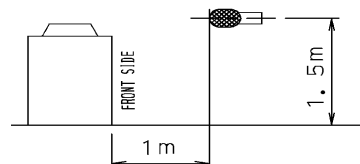

3D119522

11 Sound data

11 - 2 Sound Pressure Spectrum

REYQ12U
RXYQQ12U
RXYQ12U
RYYQ12U
RYMQ12U

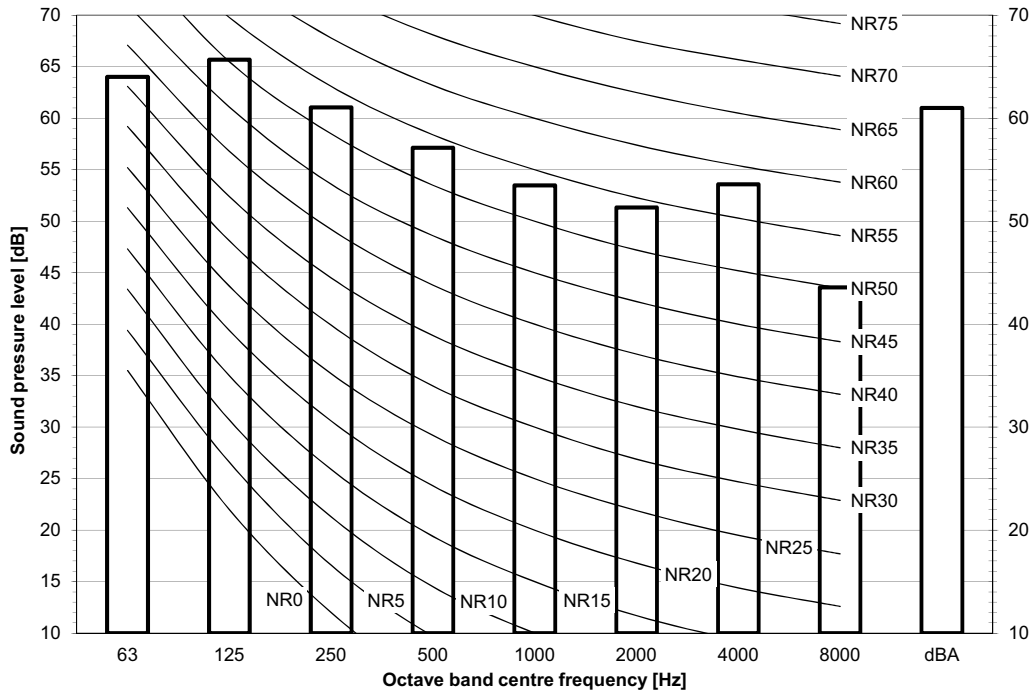

Notes

Data is valid at free field condition.
Data is valid at nominal operation condition.
dBA = A-weighted sound pressure level (A scale according to IEC).
Reference acoustic pressure 0 dB = 20 µPa

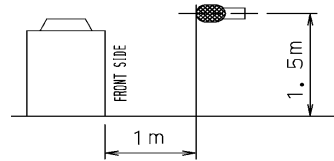

3D119523

REYQ14U
RXYQQ14U
RXYQ14U
RYYQ14U
RYMQ14U

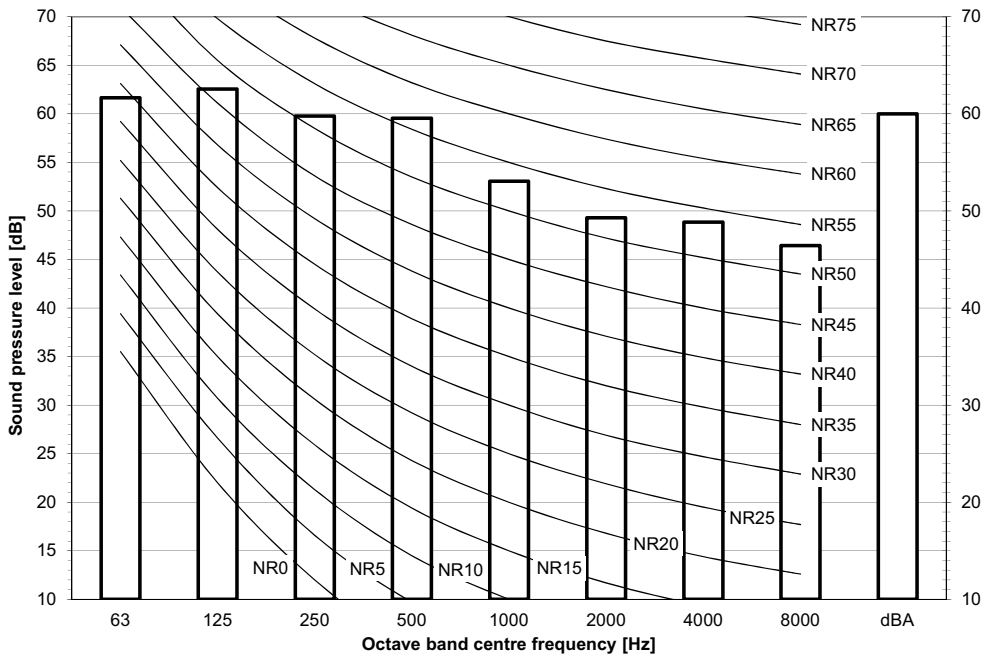

Notes

Data is valid at free field condition.
Data is valid at nominal operation condition.
dBA = A-weighted sound pressure level (A scale according to IEC).
Reference acoustic pressure 0 dB = 20 µPa

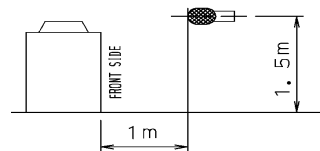

3D119524

11 Sound data

11 - 2 Sound Pressure Spectrum

11

REYQ16U
RXYQQ16U
RXYQ16U
RYYQ16U
RYMQ16U

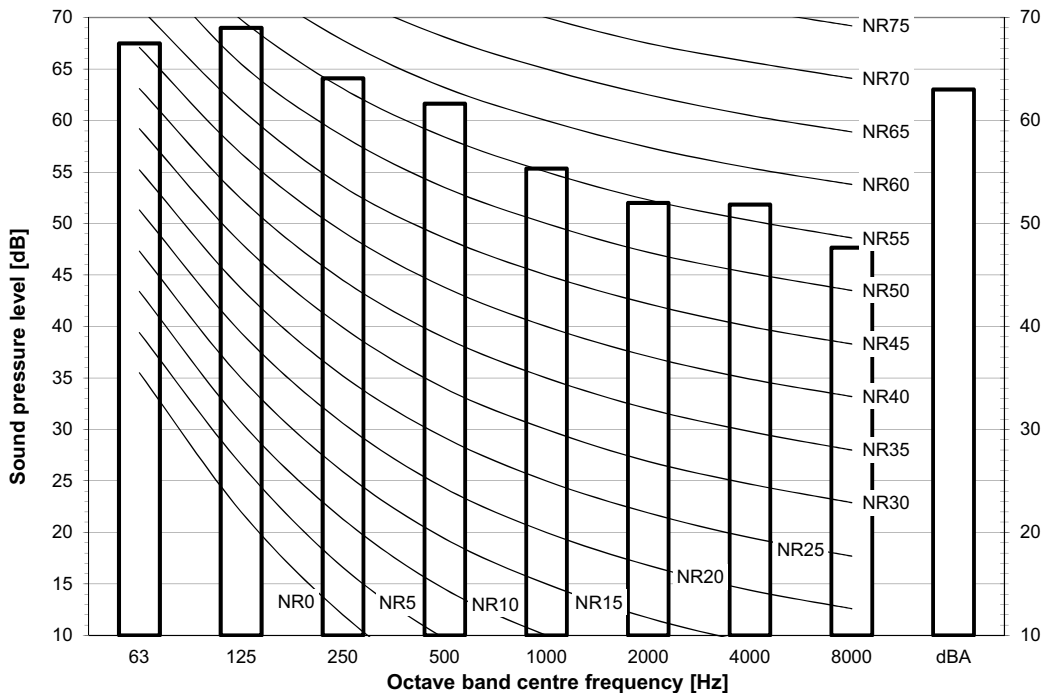

Notes

Data is valid at free field condition.
Data is valid at nominal operation condition.
dBA = A-weighted sound pressure level (A scale according to IEC).
Reference acoustic pressure 0 dB = 20 µPa

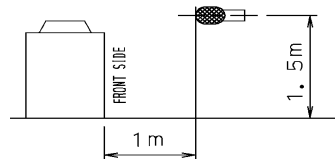

3D119525

REYQ18U
RXYQQ18U
RXYQ18U
RYYQ18U
RYMQ18U

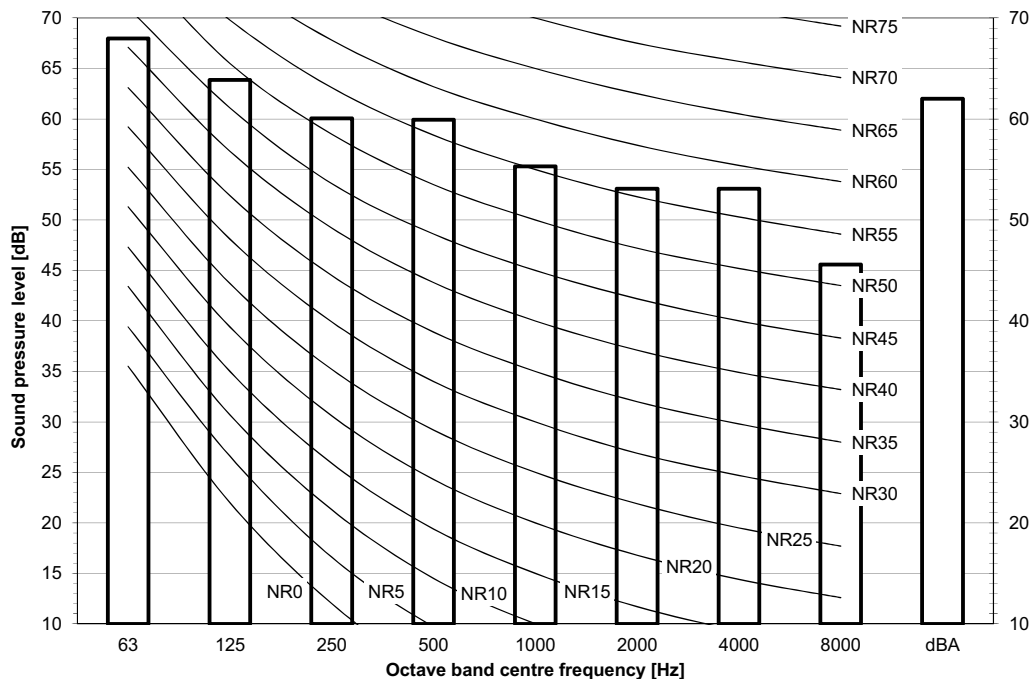

Notes

Data is valid at free field condition.
Data is valid at nominal operation condition.
dBA = A-weighted sound pressure level (A scale according to IEC).
Reference acoustic pressure 0 dB = 20 µPa

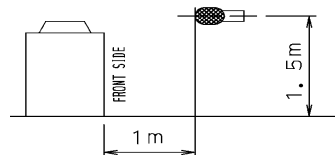

3D119526

11 Sound data

11 - 2 Sound Pressure Spectrum

REYQ20U
 RXYQQ20U
 RXYQ20U
 RYYQ20U
 RYMQ20U

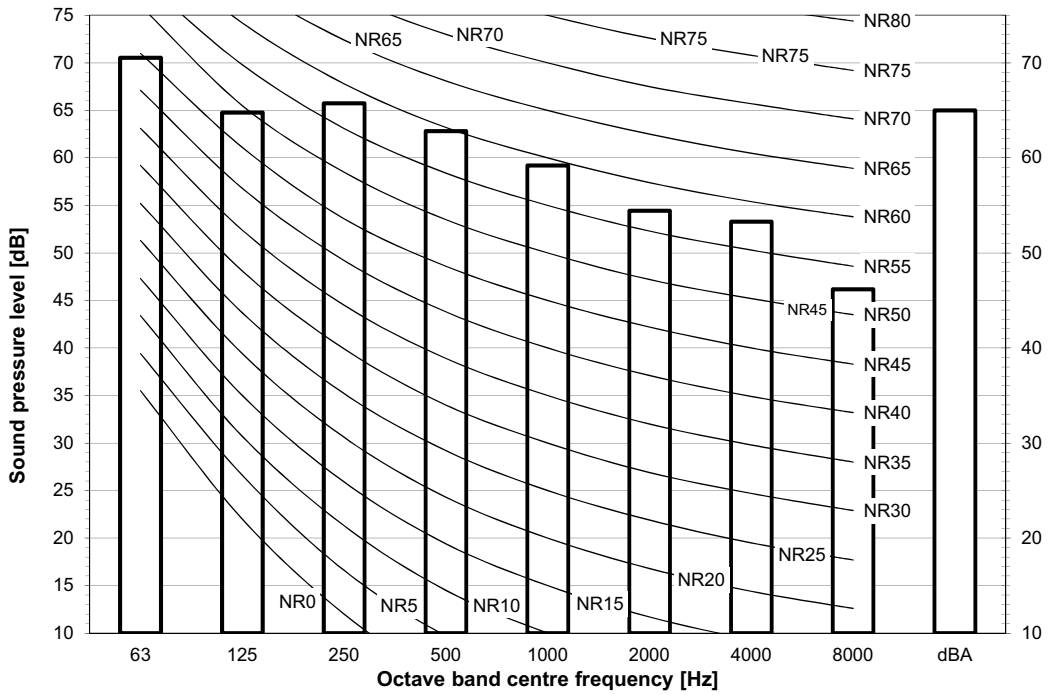

Notes

Data is valid at free field condition.
 Data is valid at nominal operation condition.
 dBA = A-weighted sound pressure level (A scale according to IEC).
 Reference acoustic pressure 0 dB = 20 µPa

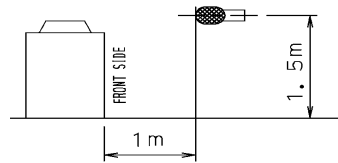

3D119527

11 Sound data

11 - 3 Sound Pressure Spectrum Quiet Mode

11

REMQ5U
REYQ8-12U
RXYQ8-12U
RXYQ8-12U
RXYTQ8UYF
RYY8-12U
RYMQ8-12U

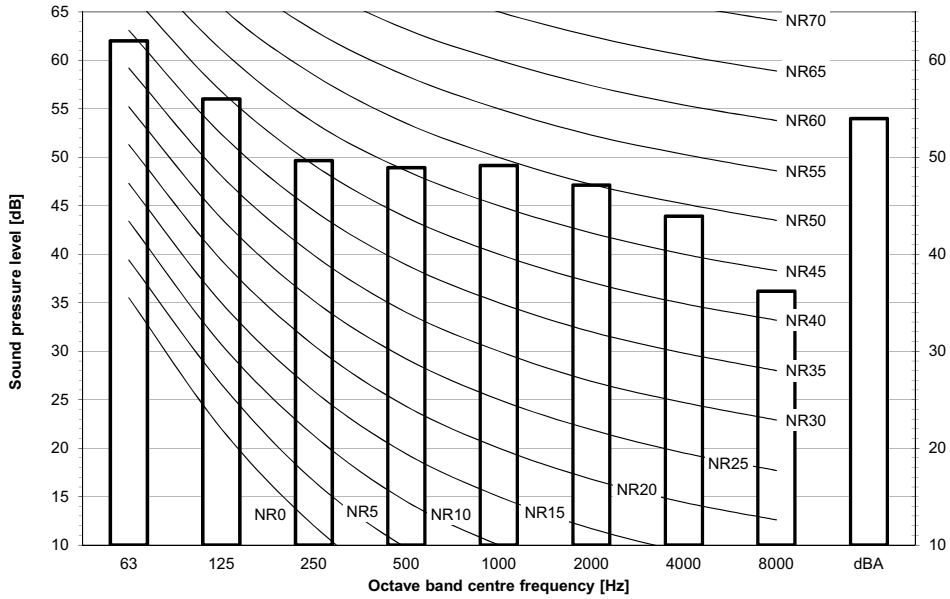

Notes
Data is valid at free field condition.
Data is valid at nominal operation condition.
dBA = A-weighted sound pressure level (A scale according to IEC).
Reference acoustic pressure 0 dB = 20 µPa
Data is valid under the following conditions
Cooling operation
Outdoor Ta: 35°C
Full load (maximum fan rps and maximum compressor rps for the dedicated low noise mode)

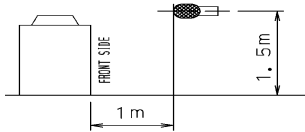

3D119535

REMQ5U
REYQ8-12U
RXYQ8-12U
RXYQ8-12U
RXYTQ8UYF
RYYQ8-12U
RYMQ8-12U

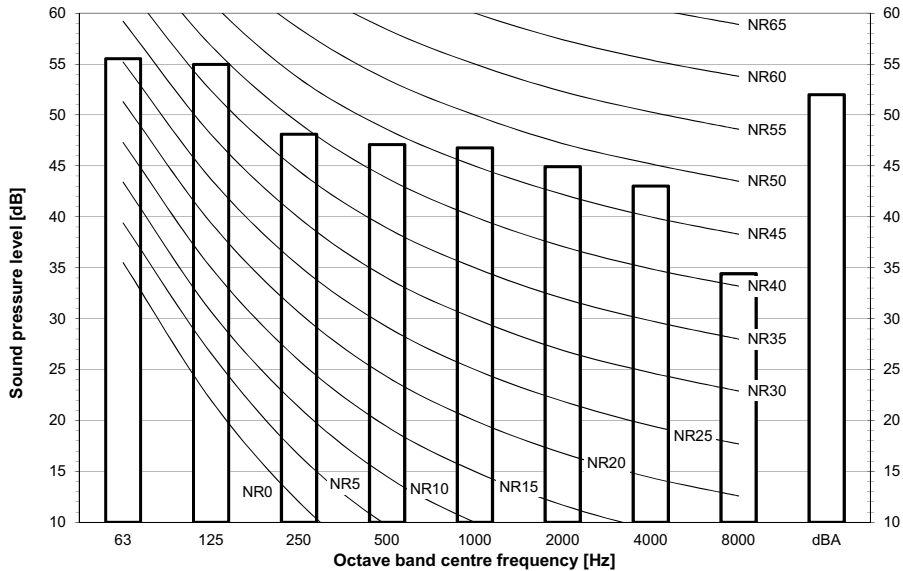

Notes
Data is valid at free field condition.
Data is valid at nominal operation condition.
dBA = A-weighted sound pressure level (A scale according to IEC).
Reference acoustic pressure 0 dB = 20 µPa
Data is valid under the following conditions
Cooling operation
Outdoor Ta: 35°C
Full load (maximum fan rps and maximum compressor rps for the dedicated low noise mode)

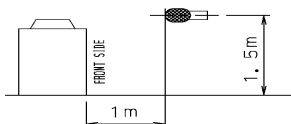

3D119536

11 Sound data

11 - 3 Sound Pressure Spectrum Quiet Mode

REMQ5U
 REYQ8-12U
 RXYQ8-12U
 RXYQ8-12U
 RXYTQ8UYF
 RYYQ8-12U
 RYMQ8-12U

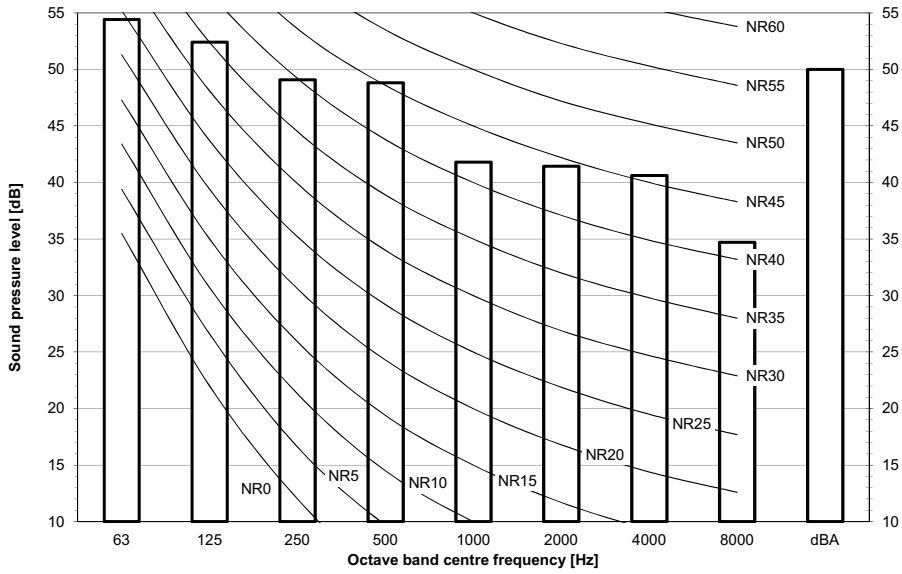

Notes
 Data is valid at free field condition.
 Data is valid at nominal operation condition.
 dBA = A-weighted sound pressure level (A scale according to IEC).
 Reference acoustic pressure 0 dB = 20 µPa
Data is valid under the following conditions
 Cooling operation
 Outdoor Ta: 35°C
 Full load (maximum fan rps and maximum compressor rps for the dedicated low noise mode)

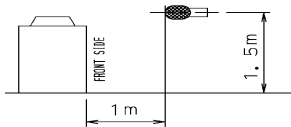

3D119537

REYQ14-16U
 RXYQ14-16U
 RXYQ14-16U
 RXYTQ14-16UYF
 RYYQ14-16U
 RYMQ14-16U

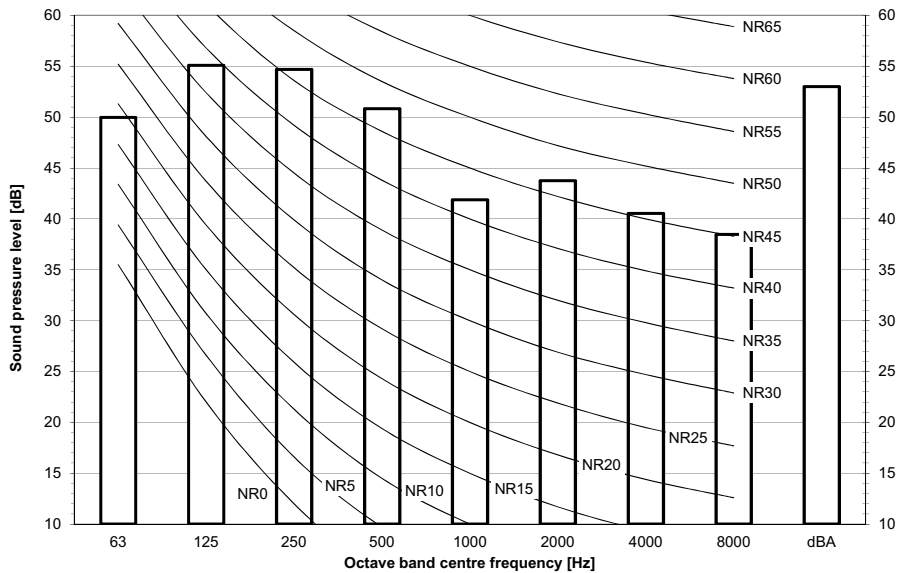

Notes
 Data is valid at free field condition.
 Data is valid at nominal operation condition.
 dBA = A-weighted sound pressure level (A scale according to IEC).
 Reference acoustic pressure 0 dB = 20 µPa
Data is valid under the following conditions
 Cooling operation
 Outdoor Ta: 35°C
 Full load (maximum fan rps and maximum compressor rps for the dedicated low noise mode)

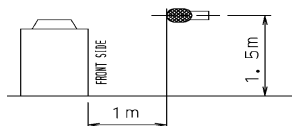

3D119538

11 Sound data

11 - 3 Sound Pressure Spectrum Quiet Mode

11

REYQ14-16U
 RXYQQ14-16U
 RXYQ14-16U
 RXYTQ14-16UYF
 RYYQ14-16U
 RYMQ14-16U

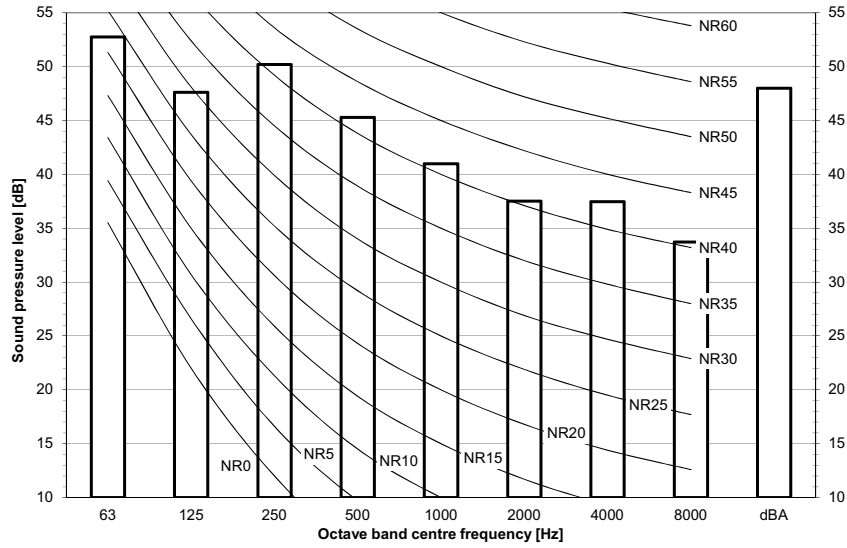

Notes
 Data is valid at free field condition.
 Data is valid at nominal operation condition.
 dBA = A-weighted sound pressure level (A scale according to IEC).
 Reference acoustic pressure 0 dB = 20 µPa
 Data is valid under the following conditions
 Cooling operation
 Outdoor Ta: 35°C
 Full load (maximum fan rps and maximum compressor rps for the dedicated low noise mode)

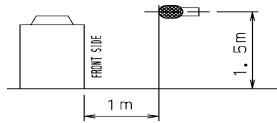

3D119539

REYQ14-16U
 RXYQQ14-16U
 RXYQ14U-16U
 RXYTQ14-16UYF
 RYYQ14-16U
 RYMQ14-16U

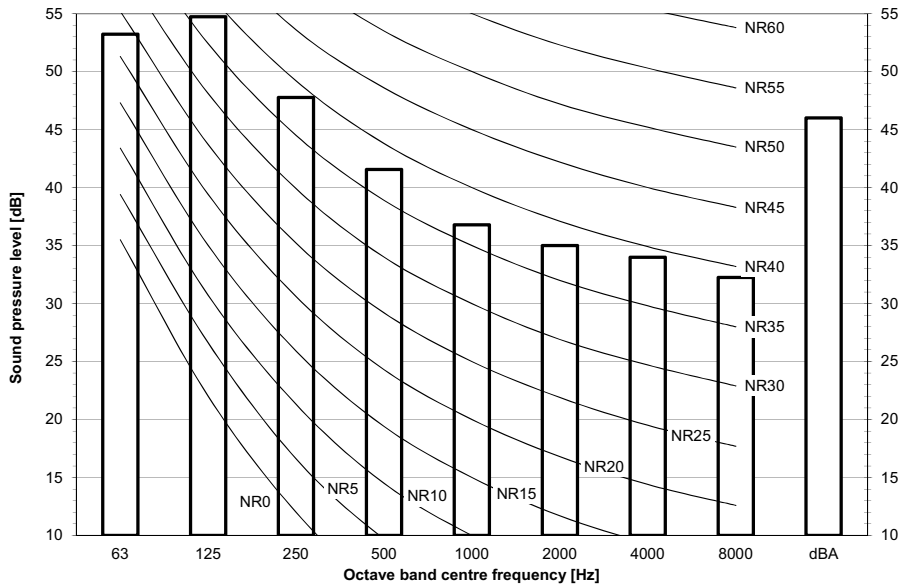

Notes
 Data is valid at free field condition.
 Data is valid at nominal operation condition.
 dBA = A-weighted sound pressure level (A scale according to IEC).
 Reference acoustic pressure 0 dB = 20 µPa
 Data is valid under the following conditions
 Cooling operation
 Outdoor Ta: 35°C
 Full load (maximum fan rps and maximum compressor rps for the dedicated low noise mode)

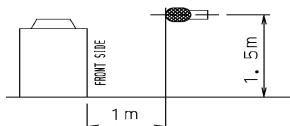

3D119540

11 Sound data

11 - 3 Sound Pressure Spectrum Quiet Mode

REYQ18-20U
 RXYQQ18-20U
 RXYQ18-20U
 RYYQ18-20U
 RYMQ18-20U

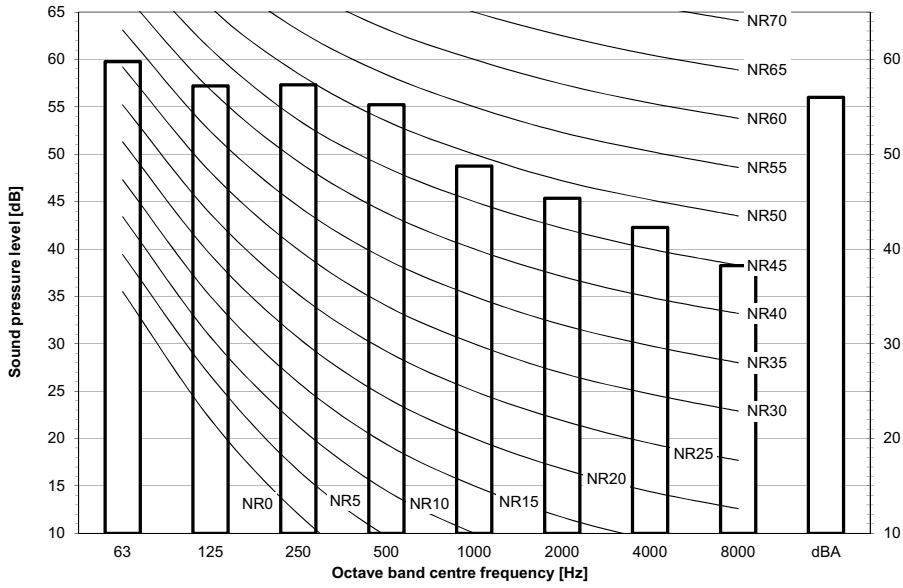

Notes
 Data is valid at free field condition.
 Data is valid at nominal operation condition.
 dBA = A-weighted sound pressure level (A scale according to IEC).
 Reference acoustic pressure 0 dB = 20 µPa
Data is valid under the following conditions
 Cooling operation
 Outdoor Ta: 35°C
 Full load (maximum fan rps and maximum compressor rps for the dedicated low noise mode)

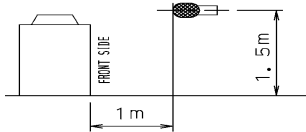

3D119541

REYQ18-20U
 RXYQQ18-20U
 RXYQ18-20U
 RYYQ18-20U
 RYMQ18-20U

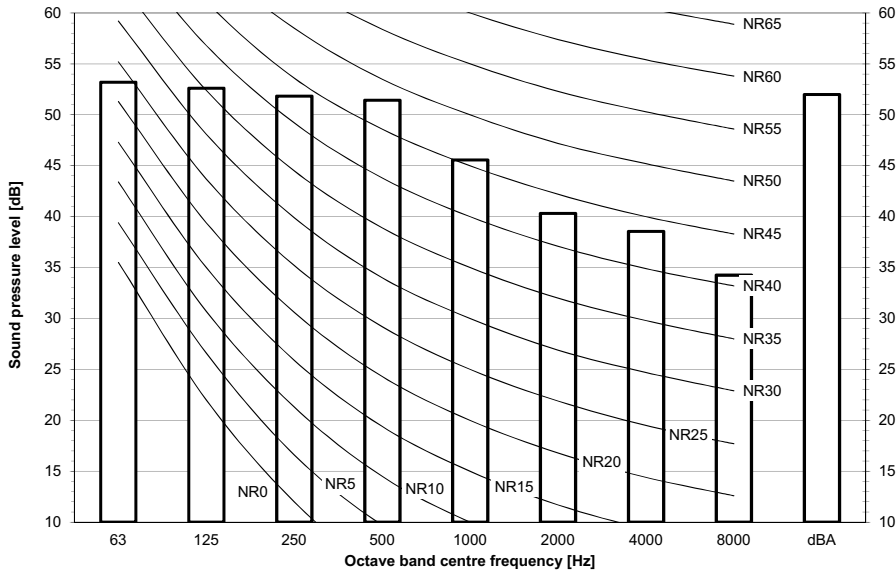

Notes
 Data is valid at free field condition.
 Data is valid at nominal operation condition.
 dBA = A-weighted sound pressure level (A scale according to IEC).
 Reference acoustic pressure 0 dB = 20 µPa
Data is valid under the following conditions
 Cooling operation
 Outdoor Ta: 35°C
 Full load (maximum fan rps and maximum compressor rps for the dedicated low noise mode)

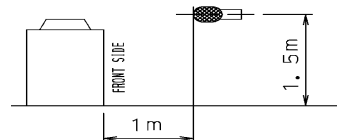

3D119542

11 Sound data

11 - 3 Sound Pressure Spectrum Quiet Mode

11

REYQ18-20U
 RXYQQ18-20U
 RXYQ18-20U
 RYYQ18-20U
 RYMQ18-20U

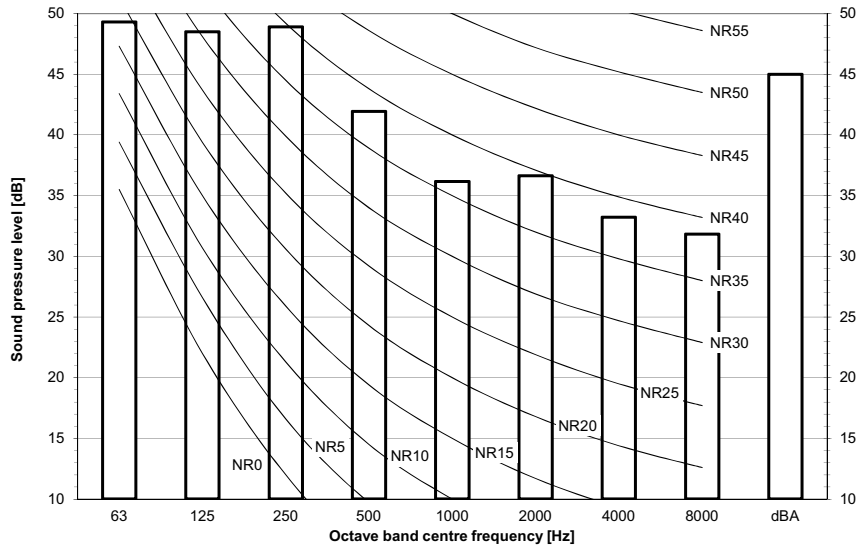

Notes
 Data is valid at free field condition.
 Data is valid at nominal operation condition.
 dBA = A-weighted sound pressure level (A scale according to IEC).
 Reference acoustic pressure 0 dB = 20 μPa
Data is valid under the following conditions
 Cooling operation
 Outdoor Ta: 35°C
 Full load (maximum fan rps and maximum compressor rps for the dedicated low noise mode)

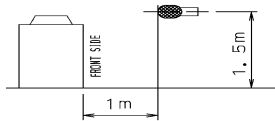

3D119543

12 Installation

12 - 1 Installation Method

REMQ5U
REYQ8-20U
RXYQ8-20U
RXYQ8-20U
RYYQ8-20U
RYMQ-20U

For single unit installation

For installation in rows

For centralised group layout

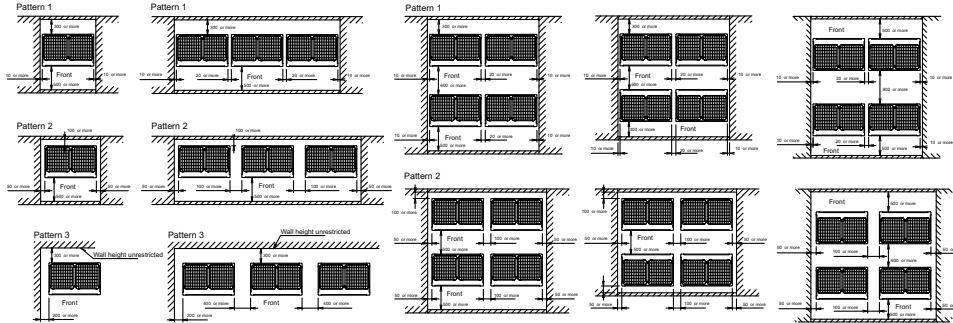

Notes

1. Height of the walls in case of patterns 1 and 2:

- Front: 1500mm
- Suction side: 500mm
- Side: height unrestricted

The installation space shown on this drawing is based on cooling operation at 35°C (outdoor temperature).

When the design outdoor ambient temperature exceeds 35°C or the load exceeds maximum ability of much generation load of heat in all outdoor unit, make sure the suction-side space is broader than the space shown on this drawing.

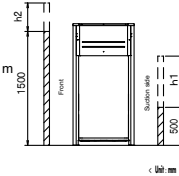

2. If the walls are higher than mentioned above, then additional service space is needed:

- suction side: service space + h1/2
- front side: service space + h2/2

3. When installing the units, select the pattern that best fits the available space.

Always keep in mind to leave sufficient space for a person to pass between unit and wall and for the air to circulate freely.

If more units are to be installed than are catered for in the above patterns, your layout should take into account of the possibility of short circuits.

4. Provide sufficient space at the front to connect refrigerant piping (comfortably).

3D118467

12 Installation

12 - 2 Fixation and Foundation of Units

12

REMQ5U
REYQ8-20U
RXYQ8-20U
RXYQ8-20U
RXYTQ8-16UYF
RYYQ8-20U
RYMQ8-20U

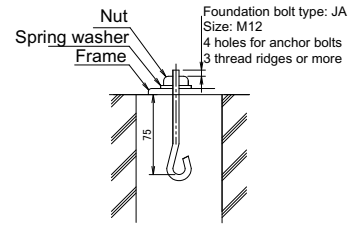
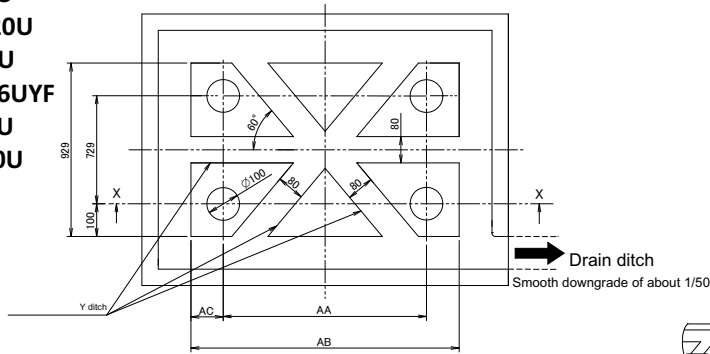

Foundation bolt fixing method

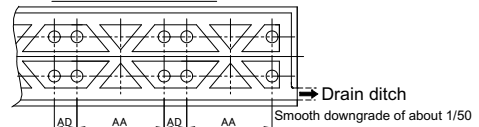

When building a foundation on the ground ↔ When building a foundation on a concrete floor

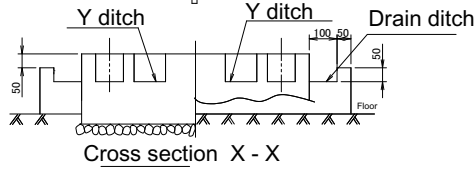

For multi-unit installation

| Model | AA | AB | AC | AD |
|------------------|------|------|-----|-----|
| RYYQ8-12U | 766 | 992 | 113 | 185 |
| RYMQ8-12U | | | | |
| RXYQ8-12U | | | | |
| RXYQ8-12U | | | | |
| REMQ5T/REYQ8-12U | | | | |
| RXYTQ8U | | | | |
| RYYQ14-20U | 1076 | 1076 | 113 | 185 |
| RYMQ14-20U | | | | |
| RXYQ14-20U | | | | |
| RXYQ14-20U | | | | |
| RXYTQ10-16U | | | | |

Notes

1. Provide a drain ditch around the foundation to drain water from the installation area.
2. The surface has to be finished with mortar. The corner edges have to be chamfered.
3. Build the foundation on a concrete floor or, if not possible, make sure the foundation surface has a rough finish.
4. Use a cement/sand/gravel ratio of 1/2/4 for the concrete, and a diameter of 10 mm for the reinforcement bars (approximately, 300mm intervals).
5. When installing the equipment on a roof, make sure to check the strength of the floor and take adequate water proofing measures. **3D118459**

12 Installation

12 - 3 Refrigerant Pipe Selection

RXYQ-U
RYYQ-Y
RYMQ-U

VRV4
Heat pump
Piping restrictions 1/3

For the reference drawing, see page 2/3.

| | Maximum piping length | | | Maximum height difference | | | Total piping length |
|--|--|---|---|---|--------------------------|----------------------------|-------------------------|
| | Longest pipe (A+[B,G,E,J]) Actual / (Equivalent) | After first branch (B,G,E,J) Actual | After first branch (for multi-outdoor) (D) Actual / (Equivalent) | Indoor-to-outdoor ⁽³⁾ (H1) Outdoor above indoor / (indoor above outdoor) | Indoor-to-indoor (H2) | Outdoor-to-outdoor (H3) | |
| Standard | | | | | | | |
| <i>VRV DX indoor units only</i> | 165/(190)m | 40m ⁽¹⁾ | 10/(13)m | 50/(40)m ⁽³⁾ | 30m | 5m | 1000m |
| <i>Standard multi-combination</i> | | | | | | | |
| <i>All multi-outdoor-unit combinations except standard multi-outdoor-unit combinations</i> | 135/(160)m | 40m ⁽¹⁾ | 10/(13)m | 50/(40)m ⁽³⁾ | 30m | 5m | 500m |
| Hydrobox connection | 135/(160)m | 40m | 10/(13)m | 50/(40)m | 15m | 5m | 300-500m ⁽⁵⁾ |
| RA connection | 100/(120)m | 50m ⁽²⁾ | - | 50/(40)m | 15m | - | 250m |
| AHU connection | Pair | 50/(55)m ⁽⁴⁾ | - | 40/(40)m | - | - | - |
| | Multi ⁽⁶⁾ | 165/(190)m | 40m | 10/13m | 40/(40)m | 15m | 1000m |
| | Mix ⁽⁷⁾ | 165/(190)m | 40m | 10/13m | 40/(40)m | 15m | 1000m |

Remark

For standard multi-outdoor-unit combinations, see 3D079534.

- (1) If all conditions below are met, the limitation can be extended up to 90 m
 - a. The piping length between all indoor units and the nearest branch kit is ≤ 40m.
 - b. It is necessary to increase the size of the gas and liquid piping if the pipe length between the first and the farthest indoor unit is >40m.
 - If the increased pipe size is larger than the pipe size of the main pipe, also increase the size of the main pipe.
 - c. When the piping size is increased, the piping length has to be counted as double.
 - The total piping length has to be within limitations.
 - d. The piping length difference between the nearest indoor unit from the first branch to the outdoor unit and the farthest indoor unit to the outdoor unit is ≤ 40m.
- (2) If the piping length between the first branch and the BP box or VRV indoor unit is more than 20m, increase the length of the gas and liquid piping between the first branch and the BP box or VRV indoor unit.
- (3) An extension to up to 90 m is possible without an additional option kit. Respect the following conditions:
 - > If the outdoor units are positioned higher than the indoor units:
 - a. Size up the liquid piping
 - b. A dedicated setting on the outdoor unit is required.
 - > If the outdoor units are positioned lower than the indoor units:
 - a. 40~60m Minimum connection ratio: 80%
 - 60~65m Minimum connection ratio: 90%
 - 65~80m Minimum connection ratio: 100%
 - 80~90m Minimum connection ratio: 110%
 - b. Size up the liquid piping
 - A dedicated setting on the outdoor unit is required.
- (4) The allowable minimum length is 5 m.
- (5) In case of multi-outdoor-unit combinations.
- (6) Multiple air handling units (AHU)(EKEXV + EKEQ kits).
- (7) Mix of AHU units and VRV DX indoor
- (8) If the equivalent piping length between is > 90m, size up the main liquid and gas piping.

12 Installation

12 - 3 Refrigerant Pipe Selection

12

RXYQ-U
RYYQ-U
RYMQ-U

VRV4
Heat pump
Piping restrictions 2/3

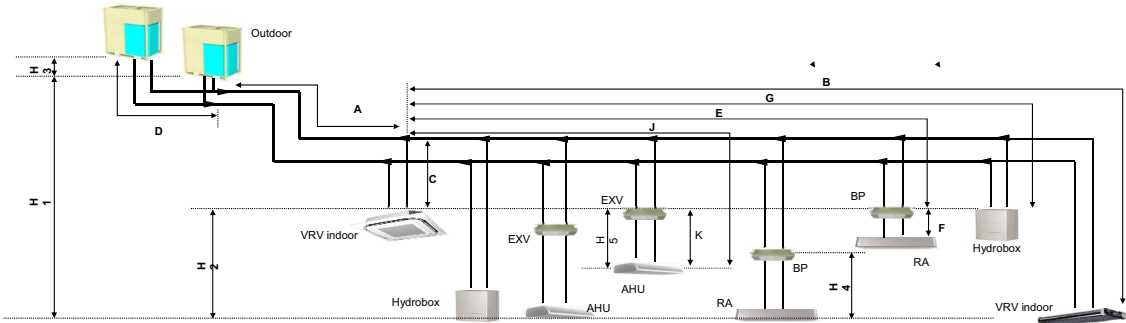

Remark

- (1) Schematic indication
Illustrations may differ from the actual appearance of the unit.
- (2) This is only to illustrate piping length limitations.
Combination of indoor unit types is not allowed.
Refer to combination table 3D079543 for details about the allowed combinations.

| | | Allowed piping length | | Maximum height difference | |
|-----------------------|----------------------|-----------------------|-------------------|---------------------------|--------------------|
| | | BP to RA (F) | EXV to AHU (K) | BP to RA (H4) | EXV to AHU (H5) |
| | | RA connection | 2~15m | - | 5m |
| AHU connection | Pair | - | ≤5m | - | 5m |
| | Multi ⁽¹⁾ | - | ≤5m | - | 5m |
| | Mix ⁽²⁾ | - | ≤5m | - | 5m |

Remark

- (1) Multiple air handling units (AHU)(EKEVX + EKEQ kits).
- (2) Mix of AHU units and VRV DX indoor

3D079540E

12 Installation

12 - 3 Refrigerant Pipe Selection

RXYQ-U
RYYQ-U
RYMQ-U

VRV4
Heat pump
Piping restrictions 3/3

| System pattern Allowed connection ratio (CR) Other combinations are not allowed. | Total | | Allowed capacity | | | |
|--|------------------------|---|--------------------|-------------------|---------------|----------------------------|
| | Capacity | Indoor unit quantity (VRV, RA, AHU, Hydrobox) | VRV DX indoor unit | RA DX indoor unit | Hydrobox unit | Air handling unit (AHU) |
| VRV DX indoor units only | 50~130% | Max.64 | 50~130% | - | - | - |
| VRV DX indoor unit + RA DX | 80~130% | Max.32 ⁽¹⁾ | 0~130% | 0~130% | - | - |
| RA DX indoor unit | 80~130% | Max.32 ⁽¹⁾ | - | 80~130% | - | - |
| VRV DX indoor unit + LT hydrobox | 50~130% | Max.32 | 50~130% | - | 0~80% | - |
| VRV DX indoor unit + AHU | 50~110% ⁽³⁾ | Max.64 ⁽²⁾ | 50~110% | - | - | 0~110% |
| AHU only Pair + multi (4) | 90~110% ⁽³⁾ | Max.64 ⁽²⁾ | - | - | - | 90~110% |

Remark

- (1) There is no restriction on the number of connectable BP boxes.
- (2) For connection with AHU
EKEXV kits are also considered indoor units.
- (3) Restrictions regarding the air handling unit capacity
- (4) Pair AHU = system with 1 air handling unit connected to one outdoor unit
Multi AHU = system with multiple air handling units connected to one outdoor unit

About ventilation applications

- I. FXMQ_MF units are considered air handling units, following air handling unit limitations.
Maximum connection ratio when combined with VRV DX indoor units: <30%.
Maximum connection ratio when only air handling units are connected: <100%.
For information on the operation range, refer to the documentation of the FXMQ_MF unit.
- II. Biddle air curtains are considered air handling units, following air handling unit limitations:
For information on the operation range, refer to the documentation of the Biddle unit.
- III. [EKEXV + EKEQ] units combined with an air handling unit are considered air handling units, following air handling unit limitations.
For information on the operation range, refer to the documentation of the EKEXV-EKEQ unit.
- IV. VKM units are considered to be regular VRV DX indoor units.
For information on the operation range, refer to the documentation of the VKM unit.
- V. Because there is no refrigerant connection with the outdoor unit (only communication F1/F2), VAM units do not have connection limitations.
However, since there is communication via F1/F2, count them as regular indoor unit when calculating the maximum allowed number of connectable indoor units.

13 Operation range

13 - 1 Operation Range

13

RXYQQ-U
RXYQ-U
RYYQ-U
RYMQ-U

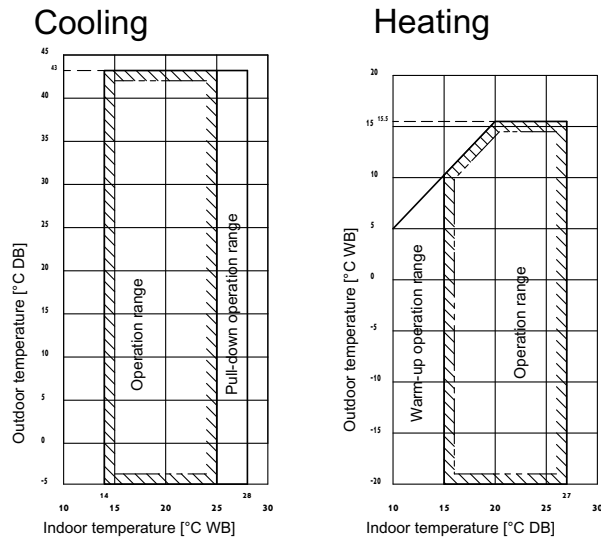

Notes

1. These figures assume the following operation conditions

Indoor and outdoor units
Equivalent piping length: 5m
Level difference: 0m

- 2. Depending on operation and installation conditions, the indoor unit can change over to freeze-up operation (indoor de-icing).
- 3. To reduce the freeze-up operation (indoor de-icing) frequency, it is recommended to install the outdoor unit in a location not exposed to wind.
- 4. Operation range is valid in case direct expansion indoor units are used.

3D118465

14 Appropriate Indoors

14 - 1 Appropriate Indoors

RYYQ-U

RYMQ-U

RXYQ-U

Recommended indoor units for ·RXYQ*U* / RYYQ*U* / RYMQ*U*· outdoor units

| HP | 8 | 10 | 12 | 14 | 16 | 18 | 20 |
|----|----------|----------|----------|----------------------|----------------------|----------------------|----------------------|
| | 4xFXMQ50 | 4xFXMQ63 | 6xFXMQ50 | 1xFXMQ50 5xFXMQ63 | 4xFXMQ63 2xFXMQ80 | 3xFXMQ50 5xFXMQ63 | 2xFXMQ50 6xFXMQ63 |

For multi outdoor units >16HP, the recommended amount of indoor units is the sum of the indoor units defined for a single outdoor unit.
For details about the allowed combinations, see the engineering databook.

Appropriate indoor units for ·RXYQ*U* / RYYQ*U* / RYMQ*U*· outdoor units

Covered by ·ENER LOT21·

- FXFQ20-25-32-40-50-63-80-100-125
- FXZQ15-20-25-32-40-50
- FXCQ20-25-32-40-50-63-80-125
- FXKQ25-32-40-63
- FXDQ15-20-25-32-40-50-63
- FXSQ15-20-25-32-40-50-63-80-100-125-140
- FXMQ50-63-80-100-125-200-250
- FXAQ15-20-25-32-40-50-63
- FXHQ32-63-100
- FXUQ71-100
- FXNQ20-25-32-40-50-63
- FXLQ20-25-32-40-50-63

Covered by ·ENER LOT10·

- FTXJ25-35-50
- FTXM20-25-35-42-50-60-71
- CTXM15
- FLXS25-35-50-60
- FVXM25-35-50
- FVXG25-35-50

Outside the scope of ·ENER LOT21·

- EKEXV50-63-80-100-125-140-200-250-400-500 + EKEQM / EKEQF
- HXY080-125
- VKM50-80-100
- CYVS100-150-200-250
- CYVM100-150-200-250
- CYVL100-150-200-250

3D118461



Daikin Europe N.V. Naamloze Vennootschap - Zandvoordestraat 300, B-8400 Oostende - Belgium - www.daikin.eu - BE 0412 120 336 - RPR Oostende

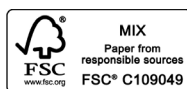
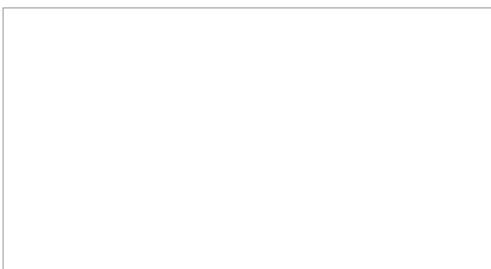

EEDEN19 02/19



The present leaflet is drawn up by way of information only and does not constitute an offer binding upon Daikin Europe N.V.. Daikin Europe N.V. has compiled the content of this leaflet to the best of its knowledge. No express or implied warranty is given for the completeness, accuracy, reliability or fitness for particular purpose of its content and the products and services presented therein. Specifications are subject to change without prior notice. Daikin Europe N.V. explicitly rejects any liability for any direct or indirect damage, in the broadest sense, arising from or related to the use and/or interpretation of this leaflet. All content is copyrighted by Daikin Europe N.V.