

Air Conditioning Technical Data

RYYQ-U



- > RYYQ8U7Y1B
- > RYYQ10U7Y1B
- > RYYQ12U7Y1B
- > RYYQ14U7Y1B
- > RYYQ16U7Y1B
- > RYYQ18U7Y1B

- > RYYQ20U7Y1B

TABLE OF CONTENTS

RYYQ-U

1	Features	2
2	Specifications	3
	Technical Specifications	3
	Electrical Specifications	6
	Technical Specifications	7
	Technical Specifications	10
	Electrical Specifications	13
	Electrical Specifications	13
	Technical Specifications	14
3	Options	16
4	Combination table	17
5	Capacity tables	20
	Capacity Table Legend	20
	Capacity Correction Factor	21
6	Dimensional drawings	34
7	Centre of gravity	35
8	Piping diagrams	36
9	Wiring diagrams	38
	Wiring Diagrams - Single Phase	38
10	External connection diagrams	42
11	Sound data	44
	Sound Power Spectrum	44
	Sound Pressure Spectrum	48
	Sound Pressure Spectrum Quiet Mode	52
12	Installation	57
	Installation Method	57
	Fixation and Foundation of Units	58
	Refrigerant Pipe Selection	59
13	Operation range	62
14	Appropriate Indoors	63

1 Features

Daikin's optimum solution with top comfort

- Covers all thermal needs of a building via a single point of contact: accurate temperature control, ventilation, hot water, air handling units and Biddle air curtains
- Wide range of indoor units: possibility to combine VRV with stylish indoor units (Daikin Emura, Nexura, ...)
- Incorporates VRV IV standards & technologies: Variable Refrigerant Temperature, continuous heating, VRV configurator, 7 segment display and full inverter compressors, 4-side heat exchanger, refrigerant cooled PCB, new DC fan motor
- Customize your VRV for best seasonal efficiency & comfort with the weather dependant Variable Refrigerant Temperature function. Increased seasonal efficiency with up to 28%. No more cold draft by supply of high outblow temperatures
- Continuous comfort: Unique continuous heating technology makes VRV IV the best alternative to traditional heating systems
- VRV configurator software for the fastest and most accurate commissioning, configuration and customisation
- Outdoor unit display for quick on-site settings and easy read out of errors together with the indication of service parameters for checking basic functions.
- Free combination of outdoor units to meet installation space or efficiency requirements
- Fits any building as also indoor installation is possible as a result of high external static pressure of up to 78.4 Pa. Indoor installation leads to less piping length, lower installation costs, increased efficiency and better visual aesthetics
- Simplified installation & guaranteed optimal efficiency with automatic charging & testing
- Easy compliance with F-gas regulation thanks to automated refrigerant containment check
- Wide piping flexibility: 30m indoor height difference, maximum piping length: 190m, total piping length: 1,000m
- The ability to control each conditioned zone individually keeps VRV system running costs to an absolute minimum
- Spread your installation cost by phased installation
- Keep your system in top condition via the Daikin Cloud Service: 24/7 monitoring for maximum efficiency, extended lifetime and immediate service support thanks to failure prediction
- Available as heating only by irreversible field setting



2 Specifications

2-1 Technical Specifications				RYYQ8U	RYYQ10U	RYYQ12U	RYYQ14U	RYYQ16U	RYYQ18U	RYYQ20U	
Continuous heating				Yes							
Recommended combination				4 x FXFQ50AV EB	4 x FXFQ63AV EB	6 x FXFQ50AV EB	1 x FXFQ50AV EB + 5 x FXFQ63AV EB	4 x FXFQ63AV EB + 2 x FXFQ80AV EB	3 x FXFQ50AV EB + 5 x FXFQ63AV EB	2 x FXFQ50AV EB + 6 x FXFQ63AV EB	
Recommended combination 2				4 x FXSQ50A2 VEB	4 x FXSQ63A2 VEB	6 x FXSQ50A2 VEB	1 x FXSQ50A2 VEB + 5 x FXSQ63A2 VEB	4 x FXSQ63A2 VEB + 2 x FXSQ80A2 VEB	3 x FXSQ50A2 VEB + 5 x FXSQ63A2 VEB	2 x FXSQ50A2 VEB + 6 x FXSQ63A2 VEB	
Recommended combination 3				4 x FXMQ50P7 VEB	4 x FXMQ63P7 VEB	6 x FXMQ50P7 VEB	1 x FXMQ50P7 VEB + 5 x FXMQ63P7 VEB	4 x FXMQ63P7 VEB + 2 x FXMQ80P7 VEB	3 x FXMQ50P7 VEB + 5 x FXMQ63P7 VEB	2 x FXMQ50P7 VEB + 6 x FXMQ63P7 VEB	
Cooling capacity	Prated,c	kW		22.4 (1)	28.0 (1)	33.5 (1)	40.0 (1)	45.0 (1)	50.4 (1)	52.0 (1)	
Heating capacity	Prated,h	kW		13.7	16.0	18.4	20.6	23.2	27.9	31.0	
	Max.	6°CWB	kW		25.0 (2)	31.5 (2)	37.5 (2)	45.0 (2)	50.0 (2)	56.5 (2)	
SEER				7.6	6.8	6.3		6.0		5.9	
SEER recommended combination 2				6.9	6.8	5.9	6.3	5.9	6.0	5.9	
SEER recommended combination 3				7.5	6.8	6.2		5.8	6.0	5.9	
SCOP				4.3		4.1	4.0		4.2	4.0	
SCOP recommended combination 2				4.2	4.3	4.1	4.0	4.1	4.2	4.0	
SCOP recommended combination 3				4.2	4.1		4.0		4.1	3.9	
ηs,c	%			302.4	267.6	247.8	250.7	236.5	238.3	233.7	
ηs,c recommended combination 2				273.6	270.5	233.5	250.0	234.2	236.8	233.9	
ηs,c recommended combination 3				295.2	267.1	246.3	246.7	230.4	238.2	233.1	
ηs,h	%			167.9	168.2	161.4	155.4	157.8	163.1	156.6	
ηs,h recommended combination 2				165.4	170.6	161.3	157.2	159.5	164.8	158.2	
ηs,h recommended combination 3				165.6	162.0	160.6	155.7	156.8	159.6	153.4	
Capacity range				HP		8	10	12	14	16	18
Maximum number of connectable indoor units				64 (3)							
Indoor index connection	Min.			100.0	125.0	150.0	175.0	200.0	225.0	250.0	
	Max.			260.0	325.0	390.0	455.0	520.0	585.0	650.0	
Dimensions	Unit	Height	mm	1,685							
		Width	mm	930			1,240				
		Depth	mm	765							
	Packed unit	Height	mm	1,820							
		Width	mm	995			1,305				
		Depth	mm	860							
Weight	Unit		kg	252			319		378		
	Packed unit		kg	265			335		395		
Packing	Material			Carton							
	Weight			1.8			2.2				
Packing 2	Material			Wood							
	Weight			11.0			14.0				
Packing 3	Material			Plastic							
	Weight			0.5			0.6				
Capacity control	Method			Inverter controlled							
Casing	Colour			Daikin White							
	Material			Painted galvanized steel plate							
Heat exchanger	Type			Cross fin coil							
	Indoor side			Air							
	Outdoor side			Air							
	Air flow rate	Cooling	Rated	m³/h	9,720	10,500	11,100	13,380	15,600	15,060	15,660
		Heating	Rated	m³/h	9,720	10,500	11,100	13,380	15,600	15,060	15,660
Compressor	Quantity			1			2				
	Type			Hermetically sealed scroll compressor							
	Crankcase heater			W							

2 Specifications

2-1 Technical Specifications				RYYQ8U	RYYQ10U	RYYQ12U	RYYQ14U	RYYQ16U	RYYQ18U	RYYQ20U	
Fan	Quantity			1			2				
	External static pressure	Max.	Pa	78							
Fan motor	Quantity			1			2				
	Type			DC motor							
	Output		W	550			750				
Sound power level	Cooling	Nom.	dBA	78.0 (4)	79.1 (4)	83.4 (4)	80.9 (4)	85.6 (4)	83.8 (4)	87.9 (4)	
	Heating	Nom.	dBA	62.7 (4)	64.8 (4)	64.9 (4)	68.3 (4)	68.6 (4)	66.3 (4)	67.0 (4)	
Sound pressure level	Cooling	Nom.	dBA	57.0 (5)		61.0 (5)	60.0 (5)	63.0 (5)	62.0 (5)	65.0 (5)	
Operation range	Cooling	Min.~Max.	°CDB	-5.0~43.0							
	Heating	Min.~Max.	°CWB	-20.0~15.5							
Refrigerant	Type			R-410A							
	GWP			2,087.5							
	Charge		TCO _{2eq}	12.3	12.5	13.2	21.5	21.7	24.4	24.6	
			kg	5.9	6.0	6.3	10.3	10.4	11.7	11.8	
Refrigerant oil	Type			Synthetic (ether) oil FVC68D							
Piping connections	Liquid	Type		Braze connection							
		OD	mm	9,52		12,7		15,9			
	Gas	Type		Braze connection							
		OD	mm	19.1	22.2	28.6					
Total piping length	System	Actual	m	1,000 (6)							
Defrost method				Reversed cycle							
Safety devices	Item	01		High pressure switch							
		02		Fan driver overload protector							
		03		Inverter overload protector							
		04		PC board fuse							
		05		Leakage current detector							
PED	Category			Category II							
	Most critical part	Name		Accumulator							
		Ps*V	Bar*l	325			415		493		
Space cooling	A Condition (35°C - 27/19)	EERd		3.0	2.3	2.4	2.6	2.1	1.9		
		Pdc	kW	22.4	28.0	33.5	40.0	45.0	50.4	52.0	
	B Condition (30°C - 27/19)	EERd		5.2	4.7	4.3	4.1	3.9	3.8	3.7	
		Pdc	kW	16.5	20.6	24.7	29.5	33.2	37.1	38.3	
	C Condition (25°C - 27/19)	EERd		9.5	8.3	7.7	7.8	7.7	7.5	7.3	
		Pdc	kW	10.6	13.3	15.9	18.9	21.3	23.9	24.6	
	D Condition (20°C - 27/19)	EERd		18.8	17.0	13.9	14.3	14.2	18.3		
		Pdc	kW	8.0	9.3	9.4	8.4	9.5	11.5		
	Space cooling recommended combination 2	A Condition (35°C - 27/19)	EERd		2.6	2.4		2.6	2.1	1.9	
			Pdc	kW	22.4	28.0	33.5	40.0	45.0	50.4	52.0
B Condition (30°C - 27/19)		EERd		4.9	4.7	4.0	4.1	3.8	3.7	3.6	
		Pdc	kW	16.5	20.6	24.7	29.5	33.2	37.1	38.3	
C Condition (25°C - 27/19)		EERd		8.8	8.5	7.1	7.9	7.6	7.5	7.3	
		Pdc	kW	10.6	13.3	15.9	18.9	21.3	23.9	24.6	
D Condition (20°C - 27/19)		EERd		15.1	17.2	13.1	14.0		18.1	18.9	
		Pdc	kW	8.8	9.3	9.1	8.4	9.5	11.4	10.9	
Space cooling recommended combination 3		A Condition (35°C - 27/19)	EERd		3.0	2.3	2.4	2.6	2.1	1.9	
			Pdc	kW	22.4	28.0	33.5	40.0	45.0	50.4	52.0
	B Condition (30°C - 27/19)	EERd		5.1	4.7	4.2	4.0	3.7		3.6	
		Pdc	kW	16.5	20.6	24.7	29.5	33.2	37.1	38.3	
	C Condition (25°C - 27/19)	EERd		9.6	8.4	7.7		7.4	7.6	7.3	
		Pdc	kW	10.6	13.3	15.9	19.0	21.3	23.9	24.6	
	D Condition (20°C - 27/19)	EERd		16.0	16.9	13.7	14.0	14.1	18.3		
		Pdc	kW	9.1	9.3	9.4	8.4	9.5	11.6		

2 Specifications

2-1 Technical Specifications			RYYQ8U	RYYQ10U	RYYQ12U	RYYQ14U	RYYQ16U	RYYQ18U	RYYQ20U	
Space heating (Average climate)	TBivalent	COPd (declared COP)	2.5	2.4	2.0	2.3	2.2	1.9	1.8	
		Pdh (declared heating cap)	kW	13.7	16.0	18.4	20.6	23.2	27.9	31.0
		Tbiv (bivalent temperature)	°C	-10						
	TOL	COPd (declared COP)	2.5	2.4	2.0	2.3	2.2	1.9	1.8	
		Pdh (declared heating cap)	kW	13.7	16.0	18.4	20.6	23.2	27.9	31.0
		Tol (temperature operating limit)	°C	-10						
	A Condition (-7°C)	COPd (declared COP)	2.7	2.6	2.4	2.6		2.4	2.1	
		Pdh (declared heating cap)	kW	12.1	14.2	16.3	18.2	20.5	24.7	27.4
	B Condition (2°C)	COPd (declared COP)	3.9			3.5		3.7	3.6	
		Pdh (declared heating cap)	kW	7.4	8.6	9.9	11.1	12.5	15.0	16.7
	C Condition (7°C)	COPd (declared COP)	6.3	6.4	6.1		6.3	6.7	6.5	
		Pdh (declared heating cap)	kW	5.0	5.5	6.4	7.1	8.0	9.7	10.7
D Condition (12°C)	COPd (declared COP)	7.9	8.2	7.9	8.5	8.6	9.0	9.1		
	Pdh (declared heating cap)	kW	5.9		6.3	4.9		7.1		
Space heating (Average climate) recommended combination 2	A Condition (-7°C)	COPd (declared COP)	2.7		2.4	2.6		2.4	2.2	
		Pdh (declared heating cap)	kW	12.1	14.2	16.3	18.2	20.5	24.7	27.4
	B Condition (2°C)	COPd (declared COP)	3.9	4.0	3.9	3.5		3.8	3.7	
		Pdh (declared heating cap)	kW	7.4	8.6	9.9	11.1	12.2	15.0	16.7
	C Condition (7°C)	COPd (declared COP)	6.3	6.5	6.1		6.3	6.8	6.5	
		Pdh (declared heating cap)	kW	5.0	5.5	6.4	7.1	8.0	9.7	10.7
	D Condition (12°C)	COPd (declared COP)	7.8	8.3	7.9	8.6	8.7	9.1	9.2	
		Pdh (declared heating cap)	kW	5.9	6.0	6.4	4.9	5.0	7.2	
	TBivalent	COPd (declared COP)	2.4		1.9	2.3	2.2	1.9	1.8	
		Pdh (declared heating cap)	kW	13.7	16.0	18.4	20.6	23.2	27.9	31.0
		Tbiv (bivalent temperature)	°C	-10						
	TOL	COPd (declared COP)	2.4		1.9	2.3	2.2	1.9	1.8	
Pdh (declared heating cap)		kW	13.7	16.0	18.4	20.6	23.2	27.9	31.0	
Tol (temperature operating limit)		°C	-10							

2 Specifications

2

2-1 Technical Specifications				RYYQ8U	RYYQ10U	RYYQ12U	RYYQ14U	RYYQ16U	RYYQ18U	RYYQ20U	
Space heating (Average climate) recommended combination 3	A Condition (-7°C)	COPd (declared COP)		2.7	2.6	2.4	2.6		2.4	2.1	
		Pdh (declared heating cap)	kW	12.1	14.2	16.3	18.2	20.5	24.7	27.4	
	B Condition (2°C)	COPd (declared COP)		3.9	3.7	3.9	3.5		3.7	3.6	
		Pdh (declared heating cap)	kW	7.4	8.6	9.9	11.1	12.5	15.0	16.7	
	C Condition (7°C)	COPd (declared COP)		6.2	6.4	6.0	6.1	6.2	6.5	6.3	
		Pdh (declared heating cap)	kW	4.9	5.5	6.4	7.1	8.0	9.7	10.7	
	D Condition (12°C)	COPd (declared COP)		7.8	8.1	7.8	8.5	8.6	8.7		
		Pdh (declared heating cap)	kW	5.8	5.9	6.2	4.9		6.9		
	TBivalent	COPd (declared COP)		2.5	2.4	2.0	2.3	2.2	1.9	1.8	
		Pdh (declared heating cap)	kW	13.7	16.0	18.4	20.6	23.2	27.9	31.0	
		Tbiv (bivalent temperature)	°C	-10							
	TOL	COPd (declared COP)		2.5	2.4	2.0	2.3	2.2	1.9	1.8	
Pdh (declared heating cap)		kW	13.7	16.0	18.4	20.6	23.2	27.9	31.0		
Tol (temperature operating limit)		°C	-10								
Cooling	Cdc (Degradation cooling)			0.25							
Heating	Cdh (Degradation heating)			0.25							
Power consumption in other than active mode	Crankcase heater mode	Cooling	PCK	kW	0.000						
		Heating	PCK	kW	0.052	0.077	0.089				
	Off mode	Cooling	POFF	kW	0.041	0.074	0.075				
		Heating	POFF	kW	0.052	0.077	0.089				
	Standby mode	Cooling	PSB	kW	0.041	0.074	0.075				
		Heating	PSB	kW	0.052	0.077	0.089				
	Thermostat-off mode	Cooling	PTO	kW	0.005	0.010					
		Heating	PTO	kW	0.056	0.097	0.098				
Indication if the heater is equipped with a supplementary heater				no							
Supplementary heater	Back-up capacity	Heating	elbu	kW	0.0						

Standard Accessories : Installation manual; Quantity : 1;

Standard Accessories : Operation manual; Quantity : 1;

Standard Accessories : Connection pipes; Quantity : 1;

2-2 Electrical Specifications				RYYQ8U	RYYQ10U	RYYQ12U	RYYQ14U	RYYQ16U	RYYQ18U	RYYQ20U
Power supply	Name			Y1						
	Phase			3N~						
	Frequency	Hz		50						
	Voltage	V		380-415						
Voltage range	Min.	%		-10						
	Max.	%		10						
Current	Nominal running current (RLA) - 50Hz	Cooling	A	7.2 (7)	10.2 (7)	12.7 (7)	15.4 (7)	18.0 (7)	20.8 (7)	26.9 (7)
Current - 50Hz	Starting current (MSC) - remark			(8)						
	Zmax	List		No requirements						
	Minimum circuit amps (MCA)	A		16.1 (9)	22.0 (9)	24.0 (9)	27.0 (9)	31.0 (9)	35.0 (9)	39.0 (9)
	Maximum fuse amps (MFA)	A		20 (10)	25 (10)	32 (10)		40 (10)		50 (10)
	Full load amps (FLA)	Total	A	1.2 (11)	1.3 (11)	1.5 (11)	1.8 (11)	2.6 (11)		
Wiring connections - 50Hz	For power supply	Quantity		5G						
	For connection with indoor	Quantity		2						
		Remark		F1,F2						
Power supply intake				Both indoor and outdoor unit						

2 Specifications

Notes

- (1) Cooling: indoor temp. 27°CDB, 19°CWB; outdoor temp. 35°CDB; equivalent piping length: 7.5m; level difference: 0m
- (2) Heating: indoor temp. 20°CDB; outdoor temp. 7°CDB, 6°CWB; equivalent refrigerant piping: 7.5m; level difference: 0m
- (3) Actual number of connectable indoor units depends on the indoor unit type (VRV indoor, Hydrobox, RA indoor, etc.) and the connection ratio restriction for the system (50% ≤ CR ≤ 130%)
- (4) Sound power level is an absolute value that a sound source generates.
- (5) Sound pressure level is a relative value, depending on the distance and acoustic environment. For more details, please refer to the sound level drawings.
- (6) Refer to refrigerant pipe selection or installation manual
- (7) RLA is based on following conditions: indoor temp. 27°CDB, 19°CWB; outdoor temp. 35°CDB
- (8) MSC means the maximum current during start up of the compressor. VRV IV uses only inverter compressors. Starting current is always ≤ max. running current.
- (9) MCA must be used to select the correct field wiring size. The MCA can be regarded as the maximum running current.
- (10) MFA is used to select the circuit breaker and the ground fault circuit interrupter (earth leakage circuit breaker).
- (11) FLA means the nominal running current of the fan

In accordance with EN/IEC 61000-3-12, it may be necessary to consult the distribution network operator to ensure that the equipment is connected only to a supply with Ssc ≥ minimum Ssc value

Maximum allowable voltage range variation between phases is 2%.

Voltage range: units are suitable for use on electrical systems where voltage supplied to unit terminal is not below or above listed range limits.

The AUTOMATIC ESEER value corresponds with normal VRV4 Heat Pump operation, taking into account advanced energy saving operation functionality (variable refrigerant temperature)

The STANDARD ESEER value corresponds with normal VRV4 Heat Pump operation, not taking into account advanced energy saving operation functionality

Sound values are measured in a semi-anechoic room.

Soundpressure system [dBA] = 10*log[10^(A/10)+10^(B/10)+10^(C/10)] , with Unit A = A dBA, Unit B = B dBA, Unit C = C dBA

EN/IEC 61000-3-12: European/international technical standard setting the limits for harmonic currents produced by equipment connected to public low-voltage system with input current > 16A and ≤ 75A per phase

Ssc: Short-circuit power

For detailed contents of standard accessories, see installation/operation manual

Multi combination (22~54HP) data is corresponding with the standard multi combination

2-3 Technical Specifications		RYYQ22U	RYYQ24U	RYYQ26U	RYYQ28U	RYYQ30U	RYYQ32U	RYYQ34U	RYYQ36U	RYYQ38U
System	Outdoor unit module 1	RYMQ10 U	RYMQ8 U	RYMQ12U			RYMQ16U			RYMQ8 U
	Outdoor unit module 2	RYMQ12 U	RYMQ16 U	RYMQ14 U	RYMQ16 U	RYMQ18 U	RYMQ16 U	RYMQ18 U	RYMQ20 U	RYMQ10 U
	Outdoor unit module 3									RYMQ20 U
Continuous heating		Yes								
Recommended combination		6 x FXFQ50 AVEB + 4 x FXFQ63 AVEB	4 x FXFQ50 AVEB + 4 x FXFQ63 AVEB + 2 x FXFQ80 AVEB	7 x FXFQ50 AVEB + 5 x FXFQ63 AVEB	6 x FXFQ50 AVEB + 4 x FXFQ63 AVEB + 2 x FXFQ80 AVEB	9 x FXFQ50 AVEB + 5 x FXFQ63 AVEB	8 x FXFQ63 AVEB + 4 x FXFQ80 AVEB	3 x FXFQ50 AVEB + 9 x FXFQ63 AVEB + 2 x FXFQ80 AVEB	2 x FXFQ50 AVEB + 10 x FXFQ63 AVEB + 2 x FXFQ80 AVEB	6 x FXFQ50 AVEB + 10 x FXFQ63 AVEB
Recommended combination 2		6 x FXSQ50 A2VEB + 4 x FXSQ63 A2VEB	4 x FXSQ50 A2VEB + 4 x FXSQ63 A2VEB + 2 x FXSQ80 A2VEB	7 x FXSQ50 A2VEB + 5 x FXSQ63 A2VEB	6 x FXSQ50 A2VEB + 4 x FXSQ63 A2VEB + 2 x FXSQ80 A2VEB	9 x FXSQ50 A2VEB + 5 x FXSQ63 A2VEB	8 x FXSQ63 A2VEB + 4 x FXSQ80 A2VEB	3 x FXSQ50 A2VEB + 9 x FXSQ63 A2VEB + 2 x FXSQ80 A2VEB	2 x FXSQ50 A2VEB + 10 x FXSQ63 A2VEB + 2 x FXSQ80 A2VEB	6 x FXSQ50 A2VEB + 10 x FXSQ63 A2VEB

2 Specifications

2

2-3 Technical Specifications				RYYQ22U	RYYQ24U	RYYQ26U	RYYQ28U	RYYQ30U	RYYQ32U	RYYQ34U	RYYQ36U	RYYQ38U
Recommended combination 3				6 x FXMQ50 P7VEB + 4 x FXMQ63 P7VEB	4 x FXMQ50 P7VEB + 4 x FXMQ63 P7VEB + 2 x FXMQ80 P7VEB	7 x FXMQ50 P7VEB + 5 x FXMQ63 P7VEB	6 x FXMQ50 P7VEB + 4 x FXMQ63 P7VEB + 2 x FXMQ80 P7VEB	9 x FXMQ50 P7VEB + 5 x FXMQ63 P7VEB	8 x FXMQ63 P7VEB + 4 x FXMQ80 P7VEB	3 x FXMQ50 P7VEB + 9 x FXMQ63 P7VEB + 2 x FXMQ80 P7VEB	2 x FXMQ50 P7VEB + 10 x FXMQ63 P7VEB + 2 x FXMQ80 P7VEB	6 x FXMQ50 P7VEB + 10 x FXMQ63 P7VEB
Cooling capacity	Prated,c		kW	61.5 (1)	67.4 (1)	73.5 (1)	78.5 (1)	83.9 (1)	90.0 (1)	95.4 (1)	97.0 (1)	102.4 (1)
Heating capacity	Prated,h		kW	34.4	36.9	39.0	41.6	46.3	46.4	51.1	54.2	60.7
	Max.	6°CWB	kW	69.0 (2)	75.0 (2)	82.5 (2)	87.5 (2)	94.0 (2)	100.0 (2)	106.5 (2)	113.0 (2)	119.5 (2)
SEER				6.9	6.8	6.7	6.5		6.4		6.3	6.9
SEER recommended combination 2				6.7	6.6	6.5	6.3					6.8
SEER recommended combination 3				6.9	6.7	6.6	6.4	6.5	6.2	6.3		6.9
SCOP				4.4	4.3	4.2		4.3	4.2		4.1	4.3
SCOP recommended combination 2				4.4	4.3	4.2		4.3	4.2	4.3	4.2	4.3
SCOP recommended combination 3				4.3	4.2			4.3	4.1	4.2	4.1	4.2
ηs,c			%	274.5	269.9	264.2	257.8	256.8	251.7	253.3	250.8	272.4
ηs,c recommended combination 2				266.5	262.6	256.1	249.3	249.8	248.3	250.9	248.7	269.2
ηs,c recommended combination 3				273.3	265.3	261.1	253.1	256.1	244.2	249.8	247.2	272.2
ηs,h			%	171.2	167.0	164.6	166.0	169.8	163.1	166.2	162.4	167.5
ηs,h recommended combination 2				172.3	167.1	165.4	166.8	170.6	164.6	167.7	164.1	168.4
ηs,h recommended combination 3				170.2	165.5	164.5	165.0	167.0	161.9	164.2	159.9	164.8
Capacity range			HP	22	24	26	28	30	32	34	36	38
Maximum number of connectable indoor units				64 (3)								
Indoor index connection	Min.			275.0	300.0	325.0	350.0	375.0	400.0	425.0	450.0	475.0
	Max.			715.0	780.0	845.0	910.0	975.0	1,040.0	1,105.0	1,170.0	1,235.0
Heat exchanger	Indoor side			Air								
	Outdoor side			Air								
	Air flow rate	Cooling	Rated	m³/h	21,600	25,320	24,480	26,700	26,160	31,200	30,660	31,260
Heating		Rated	m³/h	21,600	25,320	24,480	26,700	26,160	31,200	30,660	31,260	35,880
Sound power level	Cooling	Nom.	dBA	84.8 (4)	86.3 (4)	85.3 (4)	87.6 (4)	86.6 (4)	88.6 (4)	87.8 (4)	89.9 (4)	88.8 (4)
	Heating	Nom.	dBA	67.8 (4)	69.6 (4)	69.9 (4)	70.1 (4)	68.7 (4)	71.6 (4)	70.6 (4)	70.9 (4)	69.9 (4)
Sound pressure level	Cooling	Nom.	dBA	62.5 (5)	64.0 (5)	63.5 (5)	65.1 (5)	64.5 (5)	66.0 (5)	65.5 (5)	67.1 (5)	66.2 (5)
Refrigerant	Type			R-410A								
	GWP			2,087.5								
Refrigerant oil	Type			Synthetic (ether) oil FVC68D								
Piping connections	Liquid	Type		Braze connection								
		OD	mm	15.9			19.1					
	Gas	Type		Braze connection								
		OD	mm	28.6	34.9					41.3		
Total piping length	System	Actual	m	1,000 (6)								
PED	Category			Category II								
Space cooling	A Condition (35°C - 27/19)	EERd		2.6	2.5	2.6	2.3	2.1	2.3	2.1		2.4
		Pdc	kW	61.5	67.4	73.5	78.5	83.9	90.0	95.4	97.0	102.4
	B Condition (30°C - 27/19)	EERd		4.8	4.6		4.4	4.3		4.2	4.1	4.5
		Pdc	kW	45.3	49.7	54.2	57.8	61.8	66.3	70.3	71.5	75.5
	C Condition (25°C - 27/19)	EERd		8.5	8.6	8.2	8.1	8.2	8.1		7.9	8.5
		Pdc	kW	29.1	31.9	34.8	37.2	39.7	42.6	45.2	45.9	48.5
	D Condition (20°C - 27/19)	EERd		16.0	15.2	14.2	14.3	16.8	14.3	16.8	16.7	17.9
		Pdc	kW	18.8	15.8	16.2	16.5	21.0	19.0	20.1	20.4	21.6
Space cooling recommended combination 2	A Condition (35°C - 27/19)	EERd		2.6	2.4	2.6	2.3	2.1	2.2	2.1		2.3
		Pdc	kW	61.5	67.4	73.5	78.5	83.9	90.0	95.4	97.0	102.4
	B Condition (30°C - 27/19)	EERd		4.6	4.5	4.4	4.3	4.2			4.1	4.5
		Pdc	kW	45.3	49.7	54.1	57.8	61.8	66.3	70.3	71.5	75.4
	C Condition (25°C - 27/19)	EERd		8.2	8.4	7.9	7.8	7.9	8.0	8.1	7.9	8.4
		Pdc	kW	29.1	31.9	34.8	37.2	39.7	42.6	45.2	45.9	48.5
	D Condition (20°C - 27/19)	EERd		15.6	14.7	13.6	13.8	16.1	14.0	16.5		17.8
		Pdc	kW	18.4	15.4	15.7	16.5	20.5	18.9	20.1	20.4	21.6

8

2 Specifications

2-3 Technical Specifications			RYYQ22U	RYYQ24U	RYYQ26U	RYYQ28U	RYYQ30U	RYYQ32U	RYYQ34U	RYYQ36U	RYYQ38U	
Space cooling recommended combination 3	A Condition (35°C - 27/19)	EERd	2.5			2.3	2.1	2.2	2.1			2.4
		Pdc	kW	61.5	67.4	73.5	78.5	83.9	90.0	95.4	97.0	102.4
	B Condition (30°C - 27/19)	EERd	4.8	4.5		4.3		4.1			4.0	4.5
		Pdc	kW	45.3	49.7	54.2	57.8	61.8	66.3	70.3	71.5	75.5
	C Condition (25°C - 27/19)	EERd	8.5	8.4	8.1	8.0	8.2	7.8	8.0	7.8	8.5	
		Pdc	kW	29.1	31.9	34.8	37.2	39.7	42.6	45.2	45.9	48.5
	D Condition (20°C - 27/19)	EERd	15.8	15.2	14.0	14.1	16.6	13.8	16.6	16.5	17.9	
		Pdc	kW	18.8	15.7	16.0	16.6	21.0	19.0	20.1	20.4	21.6
Space heating (Average climate)	TBivalent	COPd (declared COP)	2.3	2.5	2.3	2.2	2.1	2.4	2.2	2.1	2.2	
		Pdh (declared heating cap)	kW	34.4	36.9	39.0	41.6	46.3	46.4	51.1	54.2	60.7
		Tbiv (bivalent temperature)	°C	-10								
	TOL	COPd (declared COP)	2.3	2.5	2.3	2.2	2.1	2.4	2.2	2.1	2.2	
		Pdh (declared heating cap)	kW	34.4	36.9	39.0	41.6	46.3	46.4	51.1	54.2	60.7
		Tol (temperature operating limit)	°C	-10								
	A Condition (-7°C)	COPd (declared COP)	2.6	2.8	2.6		2.7	2.6	2.5			
		Pdh (declared heating cap)	kW	30.4	32.6	34.5	36.8	41.0		45.2	47.9	53.7
	B Condition (2°C)	COPd (declared COP)	4.0	3.7	3.8		3.9	3.6	3.7			
		Pdh (declared heating cap)	kW	18.5	19.9	21.0	22.4	24.9	25.0	27.5	29.2	32.7
	C Condition (7°C)	COPd (declared COP)	6.3		6.1	6.2	6.5	6.3	6.5	6.4	6.5	
		Pdh (declared heating cap)	kW	11.9	13.0	13.5	14.4	16.0	16.1	17.7	18.8	21.3
	D Condition (12°C)	COPd (declared COP)	8.2	8.9	8.8	9.0			8.8	8.6	8.7	
		Pdh (declared heating cap)	kW	6.0	5.7	6.0	6.4	7.1		7.9	8.3	13.1
	Space heating (Average climate) recommended combination 2	A Condition (-7°C)	COPd (declared COP)	2.6	2.7	2.6		2.7	2.6	2.5		
			Pdh (declared heating cap)	kW	30.4	32.6	34.5	36.8	41.0		45.2	47.9
		B Condition (2°C)	COPd (declared COP)	4.1	3.7	3.8		3.9	3.6	3.8	3.7	3.9
			Pdh (declared heating cap)	kW	18.5	19.9	21.0	22.4	24.9	25.0	27.5	29.2
C Condition (7°C)		COPd (declared COP)	6.3		6.1	6.3	6.6	6.3	6.6	6.5		
		Pdh (declared heating cap)	kW	11.9	13.1		14.4	16.0	16.1	17.7	18.8	21.3
D Condition (12°C)		COPd (declared COP)	8.4	9.0	8.9	9.1			8.9	8.8		
		Pdh (declared heating cap)	kW	6.0	5.7	6.0	6.4	7.2	7.1	7.9	8.3	13.2
TBivalent		COPd (declared COP)	2.2	2.4	2.2		2.1	2.4	2.2			
		Pdh (declared heating cap)	kW	34.4	36.9	39.0	41.6	46.3	46.4	51.1	54.2	60.7
		Tbiv (bivalent temperature)	°C	-10								
TOL		COPd (declared COP)	2.2	2.4	2.2		2.1	2.4	2.2			
		Pdh (declared heating cap)	kW	34.4	36.9	39.0	41.6	46.3	46.4	51.1	54.2	60.7
		Tol (temperature operating limit)	°C	-10								

2 Specifications

2

2-3 Technical Specifications					RYYQ22U	RYYQ24U	RYYQ26U	RYYQ28U	RYYQ30U	RYYQ32U	RYYQ34U	RYYQ36U	RYYQ38U
Space heating (Average climate) recommended combination 3	A Condition (-7°C)	COPd (declared COP)			2.6	2.7	2.6		2.5	2.7	2.6	2.4	2.5
		Pdh (declared heating cap)	kW		30.4	32.6	34.5	36.8	41.0		45.2	47.9	53.7
	B Condition (2°C)	COPd (declared COP)			4.0	3.7	3.8		3.9	3.6	3.7	3.6	3.8
		Pdh (declared heating cap)	kW		18.5	19.9	21.0	22.4	24.9	25.0	27.5	29.2	32.7
	C Condition (7°C)	COPd (declared COP)			6.2	6.3	6.1	6.2	6.3		6.4	6.3	
		Pdh (declared heating cap)	kW		11.9	12.9	13.5	14.4	16.0	16.1	17.7	18.8	21.2
	D Condition (12°C)	COPd (declared COP)			8.2	8.9	8.8	9.0	8.6	9.0	8.9	8.3	8.5
		Pdh (declared heating cap)	kW		6.0	5.7	6.0	6.4	7.1		7.9	8.3	12.9
	TBivalent	COPd (declared COP)			2.3	2.4	2.2		2.1	2.4	2.2	2.1	2.2
		Pdh (declared heating cap)	kW		34.4	36.9	39.0	41.6	46.3	46.4	51.1	54.2	60.7
		Tbiv (bivalent temperature)	°C		-10								
	TOL	COPd (declared COP)			2.3	2.4	2.2		2.1	2.4	2.2	2.1	2.2
Pdh (declared heating cap)		kW		34.4	36.9	39.0	41.6	46.3	46.4	51.1	54.2	60.7	
Tol (temperature operating limit)		°C		-10									
Cooling	Cdc (Degradation cooling)			0.25									
Heating	Cdh (Degradation heating)			0.25									
Power consumption in other than active mode	Off mode	Cooling	POFF	kW	0.081	0.115		0.116	0.149	0.150	0.157		
		Heating	POFF	kW	0.103	0.129		0.141	0.154	0.166	0.192		
	Standby mode	Cooling	PSB	kW	0.081	0.115		0.116	0.149	0.150	0.157		
		Heating	PSB	kW	0.103	0.129		0.141	0.154	0.166	0.192		
	Thermostat-off mode	Cooling	PTO	kW	0.009	0.014		0.019					
		Heating	PTO	kW	0.113	0.154		0.155	0.195	0.196	0.211		
Indication if the heater is equipped with a supplementary heater				no									
Supplementary heater	Back-up capacity	Heating	elbu	kW	0.0								

Standard Accessories : Installation manual; Quantity : 1;

Standard Accessories : Operation manual; Quantity : 1;

Standard Accessories : Connection pipes; Quantity : 1;

2-4 Technical Specifications				RYYQ40U	RYYQ42U	RYYQ44U	RYYQ46U	RYYQ48U	RYYQ50U	RYYQ52U	RYYQ54U	
System	Outdoor unit module 1			RYMQ10U		RYMQ12U	RYMQ14U	RYMQ16U			RYMQ18U	
	Outdoor unit module 2			RYMQ12U	RYMQ16U					RYMQ18U		
	Outdoor unit module 3			RYMQ18U	RYMQ16U				RYMQ18U			
Continuous heating				Yes								
Recommended combination				9 x FXFQ50A VEB + 9 x FXFQ63A VEB	12 x FXFQ63A VEB + 4 x FXFQ80A VEB	6 x FXFQ50A VEB + 8 x FXFQ63A VEB + 4 x FXFQ80A VEB	1 x FXFQ50A VEB + 13 x FXFQ63A VEB + 4 x FXFQ80A VEB	12 x FXFQ63A VEB + 6 x FXFQ80A VEB	3 x FXFQ50A VEB + 13 x FXFQ63A VEB + 4 x FXFQ80A VEB	6 x FXFQ50A VEB + 14 x FXFQ63A VEB + 2 x FXFQ80A VEB	9 x FXFQ50A VEB + 15 x FXFQ63A VEB	
Recommended combination 2				9 x FXSQ50A 2VEB + 9 x FXSQ63A 2VEB	12 x FXSQ63A 2VEB + 4 x FXSQ80A 2VEB	6 x FXSQ50A 2VEB + 8 x FXSQ63A 2VEB + 4 x FXSQ80A 2VEB	1 x FXSQ50A 2VEB + 13 x FXSQ63A 2VEB + 4 x FXSQ80A 2VEB	12 x FXSQ63A 2VEB + 6 x FXSQ80A 2VEB	3 x FXSQ50A 2VEB + 13 x FXSQ63A 2VEB + 4 x FXSQ80A 2VEB	6 x FXSQ50A 2VEB + 14 x FXSQ63A 2VEB + 2 x FXSQ80A 2VEB	9 x FXSQ50A 2VEB + 15 x FXSQ63A 2VEB	

2 Specifications

2-4 Technical Specifications				RYYQ40U	RYYQ42U	RYYQ44U	RYYQ46U	RYYQ48U	RYYQ50U	RYYQ52U	RYYQ54U	
Recommended combination 3				9 x FXMQ50P 7VEB + 9 x FXMQ63P 7VEB	12 x FXMQ63P 7VEB + 4 x FXMQ80P 7VEB	6 x FXMQ50P 7VEB + 8 x FXMQ63P 7VEB + 4 x FXMQ80P 7VEB	1 x FXMQ50P 7VEB + 13 x FXMQ63P 7VEB + 4 x FXMQ80P 7VEB	12 x FXMQ63P 7VEB + 6 x FXMQ80P 7VEB	3 x FXMQ50P 7VEB + 13 x FXMQ63P 7VEB + 4 x FXMQ80P 7VEB	6 x FXMQ50P 7VEB + 14 x FXMQ63P 7VEB + 2 x FXMQ80P 7VEB	9 x FXMQ50P 7VEB + 15 x FXMQ63P 7VEB	
Cooling capacity	Prated,c		kW	111.9 (1)	118.0 (1)	123.5 (1)	130.0 (1)	135.0 (1)	140.4 (1)	145.8 (1)	151.2 (1)	
Heating capacity	Prated,h		kW	62.3	62.4	64.8	67.0	69.6	74.3	79.0	83.7	
	Max.	6°CWB	kW	125.5 (2)	131.5 (2)	137.5 (2)	145.0 (2)	150.0 (2)	156.5 (2)	163.0 (2)	169.5 (2)	
SEER				6.7	6.6	6.5	6.4					
SEER recommended combination 2				6.6		6.3	6.4	6.3		6.4		
SEER recommended combination 3				6.7	6.5	6.3		6.2	6.3	6.4		
SCOP				4.3	4.2		4.1		4.2	4.3		
SCOP recommended combination 2				4.4	4.3	4.2					4.3	
SCOP recommended combination 3				4.3	4.2		4.1		4.2			
ηs,c			%	263.5	261.2	255.9	254.9	251.7	252.8	253.7	254.1	
ηs,c recommended combination 2				259.2	259.3	249.2	252.2	248.3	250.0	251.6	252.5	
ηs,c recommended combination 3				263.2	255.4	250.1	248.3	244.2	248.0	251.5	253.9	
ηs,h			%	170.0	165.5	164.5	162.0	162.8	165.2	167.2	169.4	
ηs,h recommended combination 2				171.3	167.3	165.6	163.5	164.3	166.7	168.7	170.8	
ηs,h recommended combination 3				167.8	164.4	163.5	161.3	161.7	163.2	164.4	166.0	
Capacity range			HP	40	42	44	46	48	50	52	54	
Maximum number of connectable indoor units				64 (3)								
Indoor index connection	Min.			500.0	525.0	550.0	575.0	600.0	625.0	650.0	675.0	
	Max.			1,300.0	1,365.0	1,430.0	1,495.0	1,560.0	1,625.0	1,690.0	1,755.0	
Heat exchanger	Indoor side			Air								
	Outdoor side			Air								
	Air flow rate	Cooling	Rated	m³/h	36,660	41,700	42,300	44,580	46,800	46,260	45,720	45,180
		Heating	Rated	m³/h	36,660	41,700	42,300	44,580	46,800	46,260	45,720	45,180
Sound power level	Cooling	Nom.	dBA	87.3 (4)	89.1 (4)	89.8 (4)	89.3 (4)	90.4 (4)	89.8 (4)	89.3 (4)	88.6 (4)	
	Heating	Nom.	dBA	70.2 (4)	72.4 (4)		73.3 (4)	73.4 (4)	72.7 (4)	72.0 (4)	71.1 (4)	
Sound pressure level	Cooling	Nom.	dBA	65.2 (5)	66.5 (5)	67.2 (5)	67.0 (5)	67.8 (5)	67.5 (5)	67.1 (5)	66.8 (5)	
Refrigerant	Type			R-410A								
	GWP			2,087.5								
Refrigerant oil	Type			Synthetic (ether) oil FVC68D								
Piping connections	Liquid	Type		Braze connection								
		OD	mm	19.1								
	Gas	Type		Braze connection								
		OD	mm	41.3								
Total piping length	System	Actual	m	1,000 (6)								
PED	Category			Category II								
Space cooling	A Condition (35°C - 27/19)	EERd		2.2	2.3		2.4	2.3	2.1	2.0	1.9	
		Pdc	kW	111.9	118.0	123.5	130.0	135.0	140.4	145.8	151.2	
	B Condition (30°C - 27/19)	EERd		4.5	4.4			4.3	4.2		4.1	
		Pdc	kW	82.5	86.9	91.0	95.8	99.5	103.4	107.4	111.4	
	C Condition (25°C - 27/19)	EERd		8.3	8.2	8.1						
		Pdc	kW	53.0	55.9	58.5	61.6	64.0	66.5	69.1	71.6	
	D Condition (20°C - 27/19)	EERd		16.0	15.4	14.4	14.3		15.9	17.6	19.1	
		Pdc	kW	23.6	24.8	26.0	27.4	28.4	29.6	30.7	34.4	
Space cooling recommended combination 2	A Condition (35°C - 27/19)	EERd		2.2	2.3		2.2	2.1	2.0	1.9		
		Pdc	kW	111.9	118.0	123.5	130.0	135.0	140.4	145.8	151.2	
	B Condition (30°C - 27/19)	EERd		4.4		4.3		4.2		4.1		
		Pdc	kW	82.4	86.9	91.0	95.8	99.5	103.5	107.4	111.4	
	C Condition (25°C - 27/19)	EERd		8.1	8.2	7.9	8.1	8.0			8.1	
		Pdc	kW	53.0	55.9	58.5	61.6	63.9	66.5	69.0	71.6	
	D Condition (20°C - 27/19)	EERd		15.9	15.3	14.0			15.6	17.4	18.9	
		Pdc	kW	23.6	24.8	26.0	27.4	28.4	29.6	30.7	34.1	

2 Specifications

2

2-4 Technical Specifications			RYYQ40U	RYYQ42U	RYYQ44U	RYYQ46U	RYYQ48U	RYYQ50U	RYYQ52U	RYYQ54U		
Space cooling recommended combination 3	A Condition (35°C - 27/19)	EERd	2.2	2.3			2.2	2.1	2.0	1.9		
		Pdc	kW	111.9	118.0	123.5	130.0	135.0	140.4	145.8	151.2	
	B Condition (30°C - 27/19)	EERd	4.4	4.3			4.2	4.1				
		Pdc	kW	82.5	87.0	91.0	95.8	99.5	103.5	107.4	111.4	
	C Condition (25°C - 27/19)	EERd	8.4	8.0	7.9			7.8	7.9	8.0	8.2	
		Pdc	kW	53.0	55.9	58.5	61.6	63.9	66.5	69.1	71.6	
	D Condition (20°C - 27/19)	EERd	16.1	15.2	14.2	13.9	13.8	15.6	17.5	19.1		
		Pdc	kW	23.6	24.8	26.0	27.4	28.4	29.6	30.7	34.7	
Space heating (Average climate)	TBivalent	COPd (declared COP)	2.2	2.4	2.3	2.4		2.3	2.2	2.1		
		Pdh (declared heating cap)	kW	62.3	62.4	64.8	67.0	69.6	74.3	79.0	83.7	
		Tbiv (bivalent temperature)	°C	-10								
	TOL	COPd (declared COP)	2.2	2.4	2.3	2.4		2.3	2.2	2.1		
		Pdh (declared heating cap)	kW	62.3	62.4	64.8	67.0	69.6	74.3	79.0	83.7	
		Tol (temperature operating limit)	°C	-10								
	A Condition (-7°C)	COPd (declared COP)	2.6	2.7					2.6			
		Pdh (declared heating cap)	kW	55.1	55.2	57.3	59.3	61.6	65.7	69.9	74.0	
	B Condition (2°C)	COPd (declared COP)	4.0	3.7			3.6		3.7	3.8	3.9	
		Pdh (declared heating cap)	kW	33.5	33.6	34.9	36.1	37.5	40.0	42.5	45.1	
	C Condition (7°C)	COPd (declared COP)	6.5	6.3			6.2	6.3	6.5	6.6	6.8	
		Pdh (declared heating cap)	kW	21.6		22.4	23.2	24.1	25.7	27.4	29.0	
	D Condition (12°C)	COPd (declared COP)	8.7	8.6			8.7	8.8	8.9	9.0		
		Pdh (declared heating cap)	kW	13.1	9.9	10.0	10.3	10.7	12.0	14.2		
	Space heating (Average climate) recommended combination 2	A Condition (-7°C)	COPd (declared COP)	2.6	2.7					2.6		
			Pdh (declared heating cap)	kW	55.1	55.2	57.3	59.3	61.6	65.7	69.9	74.0
		B Condition (2°C)	COPd (declared COP)	4.0	3.7			3.6		3.7	3.8	3.9
			Pdh (declared heating cap)	kW	33.5	33.6	34.9	36.1	37.5	40.0	42.6	45.1
C Condition (7°C)		COPd (declared COP)	6.5	6.4	6.3			6.5	6.7	6.8		
		Pdh (declared heating cap)	kW	21.6		22.4	22.8	24.1	25.7	27.4	29.0	
D Condition (12°C)		COPd (declared COP)	8.8	8.7			8.8	8.9	9.0	9.1		
		Pdh (declared heating cap)	kW	13.2	10.0		10.3	10.7	12.2	14.4		
TBivalent		COPd (declared COP)	2.2	2.4	2.3	2.4		2.3	2.2	2.1		
		Pdh (declared heating cap)	kW	62.3	62.4	64.8	67.0	69.6	74.3	79.0	83.7	
		Tbiv (bivalent temperature)	°C	-10								
TOL		COPd (declared COP)	2.2	2.4	2.3	2.4		2.3	2.2	2.1		
		Pdh (declared heating cap)	kW	62.3	62.4	64.8	67.0	69.6	74.3	79.0	83.7	
		Tol (temperature operating limit)	°C	-10								

2 Specifications

2-4 Technical Specifications					RYYQ40U	RYYQ42U	RYYQ44U	RYYQ46U	RYYQ48U	RYYQ50U	RYYQ52U	RYYQ54U
Space heating (Average climate) recommended combination 3	A Condition (-7°C)	COPd (declared COP)			2.6	2.7	2.6	2.7		2.6		2.5
		Pdh (declared heating cap)	kW		55.1	55.2	57.3	59.3	61.6	65.7	69.9	74.0
	B Condition (2°C)	COPd (declared COP)			3.9	3.7		3.6		3.7	3.8	
		Pdh (declared heating cap)	kW		33.5	33.6	34.9	36.1	37.5	40.0	42.5	45.1
	C Condition (7°C)	COPd (declared COP)			6.4	6.3	6.2		6.3	6.4		6.5
		Pdh (declared heating cap)	kW		21.6		22.4	23.2	24.1	25.7	27.3	29.0
	D Condition (12°C)	COPd (declared COP)			8.4	8.6		8.7	8.8	8.7		
		Pdh (declared heating cap)	kW		12.8	9.9	10.0	10.3	10.7	11.8	13.7	
	TBivalent	COPd (declared COP)			2.2	2.4	2.3	2.4		2.2		2.1
		Pdh (declared heating cap)	kW		62.3	62.4	64.8	67.0	69.6	74.3	79.0	83.7
		Tbiv (bivalent temperature)	°C		-10							
	TOL	COPd (declared COP)			2.2	2.4	2.3	2.4		2.2		2.1
Pdh (declared heating cap)		kW		62.3	62.4	64.8	67.0	69.6	74.3	79.0	83.7	
Tol (temperature operating limit)		°C		-10								
Cooling	Cdc (Degradation cooling)			0.25								
Heating	Cdh (Degradation heating)			0.25								
Power consumption in other than active mode	Off mode	Cooling	POFF	kW	0.157	0.190		0.223		0.224	0.225	0.226
		Heating	POFF	kW	0.192	0.206		0.231		0.243	0.255	0.267
	Standby mode	Cooling	PSB	kW	0.157	0.190		0.223		0.224	0.225	0.226
		Heating	PSB	kW	0.192	0.206		0.231		0.243	0.255	0.267
	Thermostat-off mode	Cooling	PTO	kW	0.019	0.024		0.029				
		Heating	PTO	kW	0.211	0.251		0.292		0.293	0.294	
Indication if the heater is equipped with a supplementary heater				no								
Supplementary heater	Back-up capacity	Heating	elbu	kW	0.0							

Standard Accessories : Installation manual; Quantity : 1;

Standard Accessories : Operation manual; Quantity : 1;

Standard Accessories : Connection pipes; Quantity : 1;

2-5 Electrical Specifications					RYYQ22U	RYYQ24U	RYYQ26U	RYYQ28U	RYYQ30U	RYYQ32U	RYYQ34U	RYYQ36U	RYYQ38U
Power supply	Name			Y1									
	Phase			3N~									
	Frequency			50									
	Voltage			380-415									
Voltage range	Min.			-10									
	Max.			10									
Current	Nominal running current (RLA) - 50Hz	Cooling	A	22.9 (7)	25.2 (7)	28.1 (7)	30.7 (7)	33.5 (7)	36.0 (7)	38.8 (7)	44.9 (7)	44.3 (7)	
Current - 50Hz	Starting current (MSC) - remark			(8)									
	Zmax	List			No requirements								
	Minimum circuit amps (MCA)			A	46.0 (9)	51.0 (9)	55.0 (9)	59.0 (9)	62.0 (9)	66.0 (9)	70.0 (9)	76.0 (9)	
	Maximum fuse amps (MFA)			A	63 (10)			80 (10)			100 (10)		
Wiring connections - 50Hz	For power supply	Quantity			5G								
	For connection with indoor	Quantity			2								
	Remark			F1,F2									
Power supply intake				Both indoor and outdoor unit									

2-6 Electrical Specifications					RYYQ40U	RYYQ42U	RYYQ44U	RYYQ46U	RYYQ48U	RYYQ50U	RYYQ52U	RYYQ54U
Power supply	Name			Y1								
	Phase			3N~								
	Frequency			50								
	Voltage			380-415								

2 Specifications

2

2-6 Electrical Specifications				RYYQ40U	RYYQ42U	RYYQ44U	RYYQ46U	RYYQ48U	RYYQ50U	RYYQ52U	RYYQ54U
Voltage range	Min.	%		-10							
	Max.	%		10							
Current	Nominal running current (RLA) - 50Hz	Cooling	A	43.7 (7)	46.2 (7)	48.7 (7)	51.4 (7)	54.0 (7)	56.8 (7)	59.6 (7)	62.4 (7)
Current - 50Hz	Starting current (MSC) - remark			(8)							
	Zmax	List		No requirements							
	Minimum circuit amps (MCA)		A	81.0 (9)	84.0 (9)	86.0 (9)	89.0 (9)	93.0 (9)	97.0 (9)	101.0 (9)	105.0 (9)
	Maximum fuse amps (MFA)		A	100 (10)				125 (10)			
Wiring connections - 50Hz	For power supply	Quantity		5G							
	For connection with indoor	Quantity		2							
		Remark		F1,F2							
Power supply intake				Both indoor and outdoor unit							

Notes

- (1) Cooling: indoor temp. 27°CDB, 19°CWB; outdoor temp. 35°CDB; equivalent piping length: 7.5m; level difference: 0m
- (2) Heating: indoor temp. 20°CDB; outdoor temp. 7°CDB, 6°CWB; equivalent refrigerant piping: 7.5m; level difference: 0m
- (3) Actual number of connectable indoor units depends on the indoor unit type (VRV indoor, Hydrobox, RA indoor, etc.) and the connection ratio restriction for the system (50% ≤ CR ≤ 130%)
- (4) Sound power level is an absolute value that a sound source generates.
- (5) Sound pressure level is a relative value, depending on the distance and acoustic environment. For more details, please refer to the sound level drawings.
- (6) Refer to refrigerant pipe selection or installation manual
- (7) RLA is based on following conditions: indoor temp. 27°CDB, 19°CWB; outdoor temp. 35°CDB
- (8) MSC means the maximum current during start up of the compressor. VRV IV uses only inverter compressors. Starting current is always ≤ max. running current.
- (9) MCA must be used to select the correct field wiring size. The MCA can be regarded as the maximum running current.
- (10) MFA is used to select the circuit breaker and the ground fault circuit interrupter (earth leakage circuit breaker).

In accordance with EN/IEC 61000-3-12, it may be necessary to consult the distribution network operator to ensure that the equipment is connected only to a supply with Ssc ≥ minimum Ssc value

FLA means the nominal running current of the fan

Maximum allowable voltage range variation between phases is 2%.

Voltage range: units are suitable for use on electrical systems where voltage supplied to unit terminal is not below or above listed range limits.

The AUTOMATIC ESEER value corresponds with normal VRV4 Heat Pump operation, taking into account advanced energy saving operation functionality (variable refrigerant temperature)

The STANDARD ESEER value corresponds with normal VRV4 Heat Pump operation, not taking into account advanced energy saving operation functionality

Sound values are measured in a semi-anechoic room.

Soundpressure system [dBA] = 10*log[10^(A/10)+10^(B/10)+10^(C/10)] , with Unit A = A dBA, Unit B = B dBA, Unit C = C dBA

EN/IEC 61000-3-12: European/international technical standard setting the limits for harmonic currents produced by equipment connected to public low-voltage system with input current > 16A and ≤ 75A per phase

Ssc: Short-circuit power

For detailed contents of standard accessories, see installation/operation manual

Multi combination (22~54HP) data is corresponding with the standard multi combination

2-7 Technical Specifications				RYMQ10U	RYMQ12U	RYMQ14U	RYMQ16U	RYMQ18U	RYMQ20U	RYMQ8U
Dimensions	Unit	Height	mm	1,685						
		Width	mm	930	1,240					930
		Depth	mm	765						
	Packed unit	Height	mm	1,820						
		Width	mm	995	1,305					995
		Depth	mm	860						
Weight	Unit	kg	198	275		308		198		
	Packed unit	kg	211	291		324		211		
Packing	Material		Carton							
	Weight		kg	1.8	2.2					1.8

2 Specifications

2-7 Technical Specifications				RYMQ10U	RYMQ12U	RYMQ14U	RYMQ16U	RYMQ18U	RYMQ20U	RYMQ8U
Packing 2	Material			Wood						
	Weight	kg		11.0	14.0				11.0	
Packing 3	Material			Plastic						
	Weight	kg		0.5	0.6				0.5	
Capacity control	Method			Inverter controlled						
Casing	Colour			Daikin White						
	Material			Painted galvanized steel plate						
Compressor	Quantity			1	2				1	
	Type			Hermetically sealed scroll compressor						
	Crankcase heater		W	33						
Fan	Quantity			1	2				1	
	External static pressure	Max.	Pa	78						
Fan motor	Quantity			1	2				1	
	Type			DC motor						
	Output		W	550	750				550	
Sound power level	Cooling	Nom.	dBA	79.1	83.4	80.9	85.6	83.8	87.9	78.0
	Heating	Nom.	dBA	64.8	64.9	68.3	68.6	66.3	67.0	62.7
Sound pressure level	Cooling	Nom.	dBA	57.0	61.0	60.0	63.0	62.0	65.0	57.0
Operation range	Cooling	Min.~Max.	°CDB	-5.0~43.0						
	Heating	Min.~Max.	°CWB	-20.0~15.5						
Refrigerant	Type			R-410A						
	GWP			2,087.5						
	Charge		TCO ₂ eq	12.5	13.2	21.5	23.6	24.4	24.6	12.3
			kg	6.0	6.3	10.3	11.3	11.7	11.8	5.9
Refrigerant oil	Type			Synthetic (ether) oil FVC68D						
Piping connections	Liquid	Type		Braze connection						
		OD	mm	9,52	12,7			15,9		9,52
	Gas	Type		Braze connection						
		OD	mm	22.2	28.6				19.1	
	Equalizing	Type		Braze connection						
		OD	mm	22.2				28.6		19.1
Total piping length	System	Actual	m	1,000						
Defrost method				Reversed cycle						
Safety devices	Item	01		High pressure switch						
		02		Fan driver overload protector						
		03		Inverter overload protector						
		04		PC board fuse						
		05		Leakage current detector						

3 Options

3 - 1 Options

3

RXYQQ-U
RXYQ-U
RYYQ-U
RYMQ-U

No	Item	RXYQ8U RYYQ8U RXYQQ8U		RXYQ10-12U RYYQ10-12U RXYQQ10-12U		RXYQ14-18U RYYQ14-18U RXYQQ14-18U		RXYQ20U RYYQ20U RXYQQ20U		RYYQ22~54U RXYQ22~54U RXYQQ22~42U	
		8HP	10HP	12HP	14HP	16HP	18HP	20HP			
I.	Refnet header	KHRQ22M29H									
		KHRQ22M64H									
		---	---	---	KHRQ22M75H						
II.	Refnet joint	KHRQ22M20T									
		KHRQ22M29T9									
		KHRQ22M64T									
		---	---	---	KHRQ22M75T						
III.	Outdoor multi-connection kit	See note 2.									
		---	---	---	---	---	---	BHFQ22P1007			
IV.	Outdoor multi-connection kit	See note 2.									
		---	---	---	---	---	---	BHFQ22P1517			
No	Item	8HP	10HP	12HP	14HP	16HP	18HP	20HP			
1a	Cool/heat selector (switch)	See note 4.									
		KRC19-26A									
1b	Cool/heat selector (PCB)	BRP2A81									
1c	Cool/heat selector (fixing box)	KJB111A									
2	VRV configurator	EKPCAB*									
3	Heater tape kit PCB	EKBPH012T7A					EKBPH020T7A				
4	Demand PCB	See note 5.									
		DTA104A61/62*									
5	Demand PCB mounting plate	See note 5.									
		---					KKS826B1*				

Notes

- 1 All options are kits
- 2 Only for multi units
- 3 To operate the cool/heat selector function, options 1a and 1b are both required.
- 4 To mount option 1a, option 1c is required.
- 5 To install the demand PCB on the large casing type, the demand PCB mounting plate is required.

Medium casing type VRV4 heat pump: modules 8~12HP
Large casing type VRV4 heat pump: modules 14~20HP

3D120006

4 Combination table

4 - 1 Combination Table

RXYQQ-U
RXYQ-U
RYYQ-U
RYMQ-U

Heat pump VRV4
Multi-unit standard combinations table

		8HP	10HP	12HP	14HP	16HP	18HP	20HP
Heat pump	RXYQ8* / RYYQ8* / RXYQ8*	1						
	RXYQ10* / RYYQ10* / RXYQ10*		1					
	RXYQ12* / RYYQ12* / RXYQ12*			1				
	RXYQ14* / RYYQ14* / RXYQ14*				1			
	RXYQ16* / RYYQ16* / RXYQ16*					1		
	RXYQ18* / RYYQ18* / RXYQ18*						1	
Multi-combination with 2 outdoor units	RXYQ20* / RYYQ20* / RXYQ20*							1
	RXYQ22* / RYYQ22* / RXYQ22*		1	1				
	RXYQ24* / RYYQ24* / RXYQ24*	1				1		
	RXYQ26* / RYYQ26* / RXYQ26*			1	1			
	RXYQ28* / RYYQ28* / RXYQ28*			1		1		
	RXYQ30* / RYYQ30* / RXYQ30*			1			1	
	RXYQ32* / RYYQ32* / RXYQ32*					2		
	RXYQ34* / RYYQ34* / RXYQ34*					1	1	
Multi-combination with 3 outdoor units	RXYQ36* / RYYQ36* / RXYQ36*					1		1
	RXYQ38* / RYYQ38* / RXYQ38*	1	1					
	RXYQ40* / RYYQ40* / RXYQ40*		1	1			1	
	RXYQ42* / RYYQ42* / RXYQ42*		1			2		
	RXYQ44* / RYYQ44*			1		2		
	RXYQ46* / RYYQ46*				1	2		
	RXYQ48* / RYYQ48*					3		
	RXYQ50* / RYYQ50*					2	1	
	RXYQ52* / RYYQ52*					1	2	
	RXYQ54* / RYYQ54*						3	

Remark

- RXYQ8~20 = Single continuous heating
- RYYQ22~54 Multi continuous heating
- RXYQ8~20 = Single non-continuous heating
- RXYQ22~54 Multi non-continuous heating
- RXYQ8~20 Single non-continuous heating replacement (VRV4-Q)
- RXYQ22~54 Multi non-continuous heating replacement (VRV4-Q)
- 1) For single unit installation RYYQ* units (continuous heating) and RYYQ* units (non-continuous heating)
- 2) "Non-continuous heating" multi-outdoor-unit combinations consist of RXYQ8~20 units (e.g. RXYQ36*+RXYQ16*+RXYQ20*).
- 3) "Continuous heating" multi-outdoor-unit combinations consist of RYM08~20 units (e.g. RYYQ36*+RYMQ16*+RYMQ20*).
→ RYM0* units can only be used in multi-outdoor-unit combinations and cannot be used as standalone units.
- 4) RYYQ8~20* units cannot be used in multi-outdoor-unit combinations.
- 5) RYYQ8~20* "Continuous heating" multi-outdoor-unit combinations cannot contain RXYQ* units.
- 6) RXYQ8~20* "Non-continuous heating" multi-outdoor-unit combinations cannot contain RYM0* units.
- 7) Multi "non-continuous heating" replacement models only consist of RXYQ8~20 modules (e.g. RXYQ36*=RXYQ16*+RXYQ20*).
- 8) Replacement units cannot be combined with other units.
- 9) T-series outdoor units and U-series outdoor units cannot share the same refrigerant circuit. When combining these units, make sure they are part of separate refrigerant circuits.

3D120060

RYYQ8-20U
RYMQ8-20U

Compatibility list: ·VRV4· heat pump - ·RA DX· indoor unit

Wall mounted type	Emura	FTXJ20M
		FTXJ25M
		FTXJ35M
	Stylish	FTXJ50M
		FTXA20
		FTXA25
Ceiling/wall mounted	Flex	FTXA35
		FTXA42
		FTXA50
		FLXS25B
Floor standing type	FVXM	FLXS35B
		FLXS50B
		FLXS60B
	Nexura	FVXM25F
		FVXM35F
		FVXM50F
		FVXG25K
FVXG35K		
FVXG50K		

Remark

- The limitations on the use of ·RA DX· indoor units with the ·VRV4· Heat Pump are subject to the rules set out in drawings ·3D079543· and ·3D079540·.
- If you want to connect ·RA·/·SA· ·DX· cassette, ceiling-mounted, or duct indoor units, use their ·VRV DX· indoor unit equivalents instead.

3D082373D

4 Combination table

4 - 1 Combination Table

RXYQ-U
RYYQ-U
RYMQ-U

VRV4
Heat pump
Indoor unit combination restrictions
(1/2)

Indoor unit combination pattern	-VRV* DX- indoor unit	-RA DX- indoor unit	Hydrobox unit	Air handling unit (AHU) ⁽³⁾
-VRV* DX- indoor unit	O	O	O	O
-RA DX- indoor unit	O	O	X	X
Hydrobox unit	O	X	O ₁	X
Air handling unit ⁽³⁾	O	X	X	O ₂

O: Allowed
X: Not allowed

Notes

- VRV* DX- indoor unit
 - When combining -VRV DX- indoor units with other types of indoor units, respect the following combination patterns:
 Example
 Allowed : (-VRV DX- indoor unit + -Hydrobox- unit) or (-VRV DX- indoor unit + -RA DX- indoor unit) or (-VRV DX- indoor unit + -AHU-)
 Not allowed : (-VRV DX- indoor unit + (-RA DX- indoor unit & (-Hydrobox- unit or -AHU-))) or (-VRV DX- indoor unit + (-Hydrobox- unit & (-RA DX- indoor unit or -AHU-)))
- O₁
 - Only connect -Hydrobox- units to a -VRV IV- Heat Pump in combination with a -VRV DX- indoor unit.
 → Refer to the connection ratio restrictions (-3D079540 & 3D117169-).
 → Connection with only Hydrobox units: refer to the Daikin Altherma solutions.
 - Only connect -Hydrobox- units of the -HXY*- series.
 → -HXHD*- series -Hydrobox- units are not allowed.
- O₂
 - Combination of -AHU- only + control box -EKEQFA- (the combination with -VRV DX- indoor units is not allowed; maximum -54-HP for -400 + 2x500- class -EKEV- kit)
 → -X- control is possible (up to -3x- [-EKEV+EKEQFA*- boxes] can be connected to one outdoor unit (system)). No Variable Refrigerant Temperature control possible.
 → -Y- control is possible (up to -3x- [-EKEV+EKEQFA*- boxes] can be connected to one outdoor unit (system)). No Variable Refrigerant Temperature control possible.
 → -W- control is possible (up to -3x- [-EKEV+EKEQFA*- boxes] can be connected to one outdoor unit (system)). No Variable Refrigerant Temperature control possible.
 - Combination of -AHU- only + control box -EKEQMA- (not combined with -VRV DX- indoor units)
 → Z-control is possible (the allowed number of [-EKEV + EKEQMA- boxes] is determined by the connection ratio (-90-110%-) and the capacity of the outdoor unit.
- Combination of -AHU- and -VRV DX- indoor units
 → Z-control is possible (-EKEQMA*- boxes are allowed, but with a limited connection ratio).
- The combination of -AHU- with -Hydrobox- units or -RA DX- indoor units is not allowed.
- (3) The following units are considered AHUs:
 - -EKEV + EKEQ(MA/FA) + AHU- coil
 - -Biddle- air curtain
 - -FXMQ_MF- units

Information

- -VKM- units are considered to be regular -VRV DX- indoor units.

3D079543F

RXYQ-U
RYYQ-U
RYMQ-U

VRV4
Heat pump
Indoor unit combination restrictions
(2/2)

Combination table	RYYQ*	RYYQ*	RXYQ* RXMLQ* RXYLQ*	RXYQ* RXMLQ* RXYLQ*
	Single continuous heating	Multi continuous heating	Single non-continuous heating	Multi non-continuous heating
-VRV* DX- indoor unit	O	O	O	O
-RA DX- indoor unit	O	X	O	X
Hydrobox unit	O	O ₁	O	O ₁
Air handling unit (AHU) ⁽²⁾	O	O	O	O

O: Allowed
X: Not allowed

Notes

- O₁
 - Available upon request through the -SPN- procedure.
- (2) The following units are considered AHUs:
 - -EKEV + EKEQ(MA/FA) + AHU- coil
 - -Biddle- air curtain
 - -FXMQ_MF- units

3D079543F

4 Combination table

4 - 1 Combination Table

REMQ5U,REYQ8-20U,RXYQQ8-20U, RXYTQ8-16UYF,RYYQ8-20U,RYMQ8-20U

Unit combination restrictions: VRV4 outdoor units (all models) + 15-class indoor units

Units in scope: FXZQ15A and FXAQ15A.

1. In case the system contains these indoor units and the total connection ratio (CR) $\leq 100\%$: no special restrictions. Follow the restrictions that apply to regular VRV DX indoor units.
2. In case the system contains these indoor units and the total connection ratio (CR) $> 100\%$: special restrictions apply.
 - A. When the connection ratio (CR1) of the sum of all FXZQ15A and/or FXAQ15A units in the system $\leq 70\%$, and ALL other VRV DX indoor units have an individual capacity class > 50 : no special restrictions.
 - B. When the connection ratio (CR1) of the sum of all FXZQ15A and/or FXAQ15A units in the system $\leq 70\%$, and NOT ALL other VRV DX indoor units have an individual capacity class > 50 : the restrictions below apply.
 - $100\% < CR \leq 105\% \rightarrow$ CR1 of the sum of all FXZQ15A and/or FXAQ15A indoor units in the system must be $\leq 70\%$.
 - $105\% < CR \leq 110\% \rightarrow$ CR1 of the sum of all FXZQ15A and/or FXAQ15A indoor units in the system must be $\leq 60\%$.
 - $110\% < CR \leq 115\% \rightarrow$ CR1 of the sum of all FXZQ15A and/or FXAQ15A indoor units in the system must be $\leq 40\%$.
 - $115\% < CR \leq 120\% \rightarrow$ CR1 of the sum of all FXZQ15A and/or FXAQ15A indoor units in the system must be $\leq 25\%$.
 - $120\% < CR \leq 125\% \rightarrow$ CR1 of the sum of all FXZQ15A and/or FXAQ15A indoor units in the system must be $\leq 10\%$.
 - $125\% < CR \leq 130\% \rightarrow$ FXZQ15A and FXAQ15A cannot be used

REMARK

Only the 15-class indoor units explicitly mentioned on this page are in scope. Other indoor units follow the rules that apply to regular VRV DX indoor units.

3D104665

5 Capacity tables

5 - 1 Capacity Table Legend

5

In order to fulfill more your requirements on quick access of data in the format you require, we have developed a tool to consult capacity tables.

Below you can find the link to the capacity table database and an overview of all the tools we have to help you select the correct product:

- Capacity table database: lets you find back and export quickly the capacity information you are looking for based upon unit model, refrigerant temperature and connection ratio.

[Click here to access the capacity table viewer.](#)



- For more information about all our tools we offer [click here to see the overview](#) on my.daikin.eu



5 Capacity tables

5 - 2 Capacity Correction Factor

RXYQQ-U
RXYQ-U
RYYQ-U
RYMQ-U

VRV4 Heat pump Integrated heating capacity coefficient

The heating capacity tables do not take into account the capacity reduction in case of frost accumulation or defrost operation. The capacity values that take these factors into account, or in other words, the integrated heating capacity values, can be calculated as follows:

Formula

- A = Integrated heating capacity
- B = Capacity characteristics value (see table)
- C = Integrated correction factor for frost accumulation (see table)
- A = B * C

Inlet air temperature of heat exchanger

[°CDB/°CWB]	-7/-7,6 or less	-5/-5,6	-3/-3,7	0/0,7	3/2,2	5/4,1	7/6
Integrated correction factor for frost accumulation C							
8HP	0,95	0,93	0,88	0,84	0,85	0,90	1,00
10HP	0,95	0,93	0,87	0,79	0,80	0,88	1,00
12HP	0,95	0,92	0,87	0,75	0,76	0,85	1,00
14HP	0,95	0,92	0,86	0,72	0,73	0,84	1,00
16HP	0,95	0,92	0,86	0,72	0,72	0,83	1,00
18HP	0,95	0,93	0,88	0,84	0,85	0,90	1,00
20HP	0,95	0,93	0,88	0,84	0,85	0,90	1,00
22HP	0,95	0,92	0,87	0,77	0,78	0,86	1,00
24HP	0,95	0,92	0,87	0,75	0,76	0,85	1,00
26HP	0,95	0,92	0,86	0,73	0,74	0,84	1,00
28HP	0,95	0,92	0,86	0,73	0,74	0,84	1,00
30HP	0,95	0,93	0,87	0,80	0,81	0,88	1,00
32HP	0,95	0,92	0,86	0,71	0,72	0,83	1,00
34HP	0,95	0,92	0,87	0,78	0,79	0,87	1,00
36HP	0,95	0,92	0,87	0,78	0,79	0,87	1,00
38HP	0,95	0,93	0,88	0,83	0,84	0,89	1,00
40HP	0,95	0,93	0,87	0,80	0,81	0,88	1,00
42HP	0,95	0,92	0,86	0,73	0,74	0,84	1,00
44HP	0,95	0,92	0,86	0,72	0,73	0,84	1,00
46HP	0,95	0,92	0,86	0,72	0,72	0,83	1,00
48HP	0,95	0,92	0,86	0,71	0,72	0,83	1,00
50HP	0,95	0,92	0,87	0,76	0,77	0,86	1,00
52HP	0,95	0,93	0,87	0,80	0,81	0,88	1,00
54HP	0,95	0,93	0,88	0,84	0,85	0,90	1,00

Notes

The figure shows the integrated heating capacity for a single cycle (from one defrost operation to the next).

When there is an accumulation of snow against the outdoor unit heat exchanger, there will always be a temporary reduction in capacity depending on the outdoor temperature (°C DB), relative humidity (RH) and the amount of frosting which occurs.

The multi-combination data 22~54HP corresponds with the standard multi-combination of drawing 3D079534.

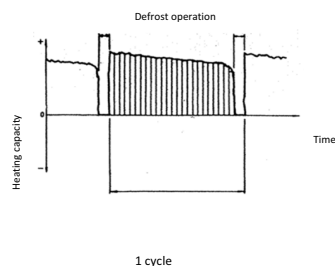

3D079898A

5 Capacity tables

5 - 2 Capacity Correction Factor

5

RXYQQ8U
RXYQ8U
RYYQ8U
RYMQ8U

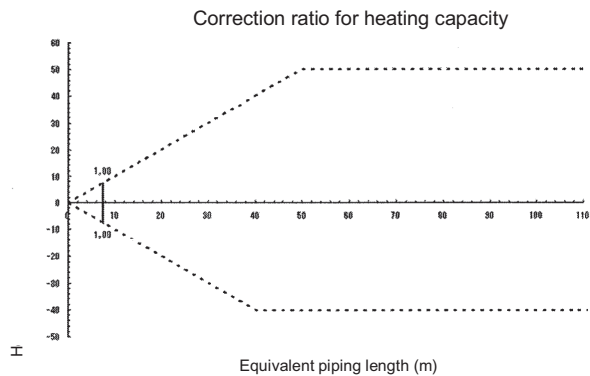
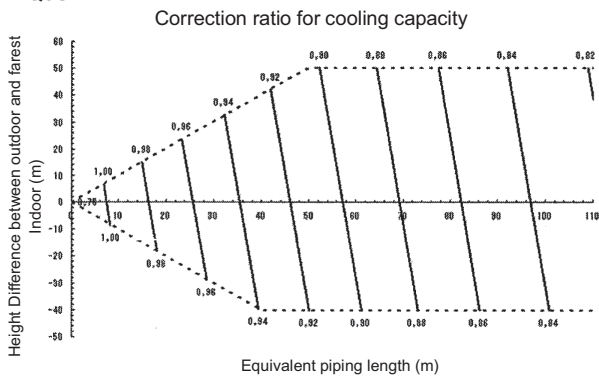

NOTES

- These figures illustrate the correction ratio for piping length in capacity for a standard indoor unit system at maximum load (with the thermostat set to maximum) under standard conditions. Moreover, under partial load conditions, there is only a minor deviation for the capacity correction ratio, shown in the above figures.
- With this outdoor unit, constant evaporating pressure control when cooling and constant condensing pressure control when heating is carried out.
- Method of calculating the capacity of the outdoor units**
The maximum capacity of the system will be either the total capacity of the indoor units or the maximum capacity of the outdoor units as mentioned below, whichever is smaller.

Condition: Indoor connection ratio does not exceed 100%.

$$\text{Maximum capacity of outdoor units} = \text{Capacity of outdoor units from capacity table at the 100\% connection ratio} \times \text{Correction ratio of piping to furthest indoor}$$

Condition: Indoor connection ratio exceeds 100%.

$$\text{Maximum capacity of outdoor units} = \text{Capacity of outdoor units from capacity table at installed connection ratio} \times \text{Correction ratio of piping to furthest indoor}$$

- When level difference is 50 m or more (see installation manual and 3D079540 / 3D079543) and equivalent pipe length is 90 m or more, the diameter of the main gas and liquid pipes (outdoor unit - branch sections) must be increased. For new diameters, see below.

Model	Gas	Liquid
8HP	22.2	12.7

- When the pipe length after the first refrigerant branch kit is more than 40 m, pipe size between first and final branch kit must be increased (only for VRV DX indoor units; details see installation manual).
*Refer to the installation manual for allowed system setups and rules for dedicated indoor connection types.

Diameter of main pipes (standard size)

Model	Gas	Liquid
8HP	19.1	9.5

- Equivalent length used in the above figures is based upon the following equivalent length

$$\text{Equivalent piping length} = \text{Equivalent length of main pipe} \times \text{Correction factor} + \text{Equivalent length of branch pipes}$$

Choose the correction factor from the following table. When cooling capacity is calculated: gas pipe size. When heating capacity is calculated: liquid pipe size.

	Correction factor	
	Standard size	Size increase
Cooling (gas pipe)	1.0	0.5
Heating (liquid pipe)	1.0	0.5

Example

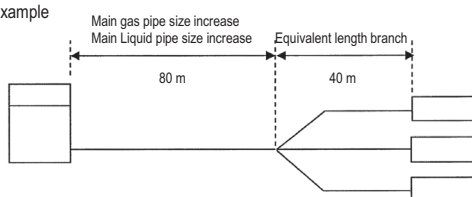

In the above case (Cooling) Overall equivalent length = 80 m x 0.5 + 40 m = 80 m
(Heating) Overall equivalent length = 80 m x 0.5 + 40 m = 80 m
The rate of change in cooling capacity when height difference = 0 is thus approximately 0.86
heating capacity when height difference = 0 is thus approximately 1.0

3D079897A

5 Capacity tables

5 - 2 Capacity Correction Factor

RXYQQ10U
RXYQ10U
RYYQ10U
RYMQ10U

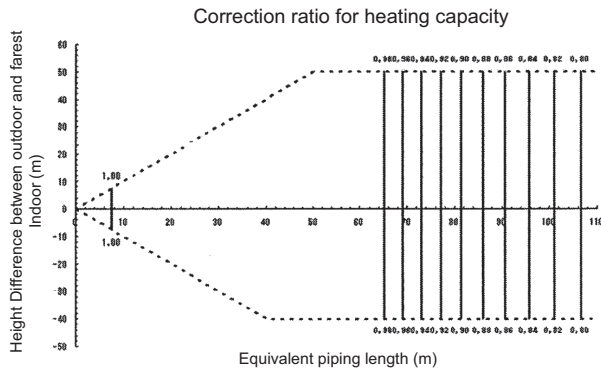
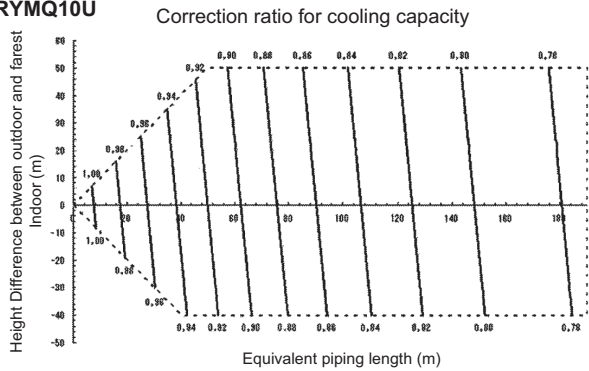

NOTES

- These figures illustrate the correction ratio for piping length in capacity for a standard indoor unit system at maximum load (with the thermostat set to maximum) under standard conditions. Moreover, under partial load conditions, there is only a minor deviation for the capacity correction ratio, shown in the above figures.
- With this outdoor unit, constant evaporating pressure control when cooling and constant condensing pressure control when heating is carried out.
- Method of calculating the capacity of the outdoor units
The maximum capacity of the system will be either the total capacity of the indoor units or the maximum capacity of the outdoor units as mentioned below, whichever is smaller.

Condition: Indoor connection ratio does not exceed 100%.

$$\text{Maximum capacity of outdoor units} = \text{Capacity of outdoor units from capacity table at the 100\% connection ratio} \times \text{Correction ratio of piping to furthest indoor}$$

Condition: Indoor connection ratio exceeds 100%.

$$\text{Maximum capacity of outdoor units} = \text{Capacity of outdoor units from capacity table at installed connection ratio} \times \text{Correction ratio of piping to furthest indoor}$$

- When level difference is 50 m or more (see installation manual and 3D079540 / 3D079543) and equivalent pipe length is 90 m or more, the diameter of the main gas and liquid pipes (outdoor unit - branch sections) must be increased. For new diameters, see below.

Model	Gas	Liquid
RXYQ10P	25.4*	12.7

*If not available on site, do not increase. If not increased correction factor should be applied to the equivalent length (see note 6).

- When the pipe length after the first refrigerant branch kit is more than 40 m, pipe size between first and final branch kit must be increased (only for VRV DX indoor units; details see installation manual).

*Refer to the installation manual for allowed system setups and rules for dedicated indoor connection types.

Diameter of main pipes (standard size)

Model	Gas	Liquid
10 HP	22.2	9.5

- Equivalent length used in the above figures is based upon the following equivalent length

$$\text{Equivalent piping length} = \text{Equivalent length of main pipe} \times \text{Correction factor} + \text{Equivalent length of branch pipes}$$

Choose the correction factor from the following table. When cooling capacity is calculated: gas pipe size When heating capacity is calculated: liquid pipe size

	Correction factor	
	Standard size	Size increase
Cooling (gas pipe)	1.0	0.5
Heating (liquid pipe)	1.0	0.5

Example

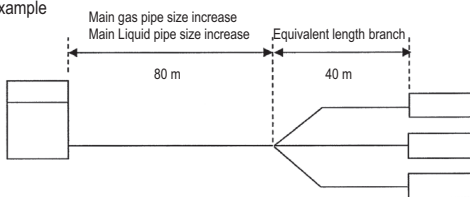

In the above case (Cooling) Overall equivalent length = 80 m x 0.5 + 40 m = 80 m
(Heating) Overall equivalent length = 80 m x 0.5 + 40 m = 80 m

The rate of change in cooling capacity when height difference = 0 is thus approximately 0.87
heating capacity when height difference = 0 is thus approximately 0.90

3D079897A

5 Capacity tables

5 - 2 Capacity Correction Factor

5

RXYQQ12,14,16,24,36U
 RXYQ12,14,24,36U
 RYYQ12,14,24,36U
 RYMQ12,14U

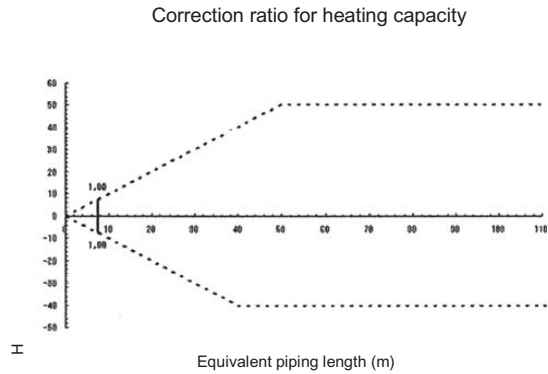
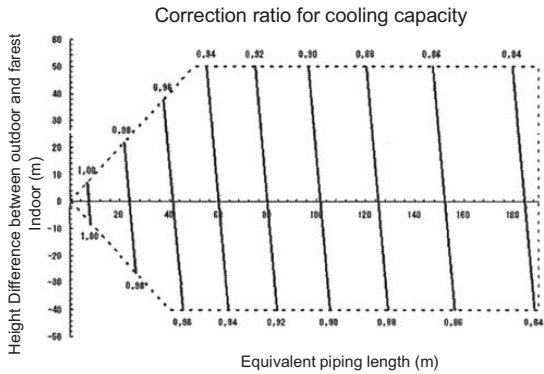

NOTES

- These figures illustrate the correction ratio for piping length in capacity for a standard indoor unit system at maximum load (with the thermostat set to maximum) under standard conditions. Moreover, under partial load conditions, there is only a minor deviation for the capacity correction ratio, shown in the above figures.
- With this outdoor unit, constant evaporating pressure control when cooling and constant condensing pressure control when heating is carried out.
- Method of calculating the capacity of the outdoor units
 The maximum capacity of the system will be either the total capacity of the indoor units or the maximum capacity of the outdoor units as mentioned below, whichever is smaller.

Condition: Indoor connection ratio does not exceed 100%.

$$\text{Maximum capacity of outdoor units} = \text{Capacity of outdoor units from capacity table at the 100\% connection ratio} \times \text{Correction ratio of piping to furthest indoor}$$

Condition: Indoor connection ratio exceeds 100%.

$$\text{Maximum capacity of outdoor units} = \text{Capacity of outdoor units from capacity table at installed connection ratio} \times \text{Correction ratio of piping to furthest indoor}$$

- When level difference is 50 m or more (see installation manual and 3D079540 / 3D079543) and equivalent pipe length is 90 m or more, the diameter of the main gas and liquid pipes (outdoor unit - branch sections) must be increased. For new diameters, see below.

Model	Gas	Liquid
12 HP	28.6	15.9
14 HP	28.6	15.9
24 HP	34.9	19.1
36 HP	41.3	22.2

- When the pipe length after the first refrigerant branch kit is more than 40 m, pipe size between first and final branch kit must be increased (only for VRV DX indoor units; details see installation manual).
 *Refer to the installation manual for allowed system setups and rules for dedicated indoor connection types.

Diameter of main pipes (standard size)

Model	Gas	Liquid
12 HP	28.6	12.7
14 HP	28.6	12.7
24 HP	34.9	15.9
36 HP	41.3	19.1

- Equivalent length used in the above figures is based upon the following equivalent length

$$\text{Equivalent piping length} = \text{Equivalent length of main pipe} \times \text{Correction factor} + \text{Equivalent length of branch pipes}$$

Choose a correction factor from the following table. When cooling capacity is calculated: gas pipe size. When heating capacity is calculated: liquid pipe size

	Correction factor	
	Standard size	Size increase
Cooling (gas pipe)	1,0	0,5
Heating (liquid pipe)	1,0	0,5

Example

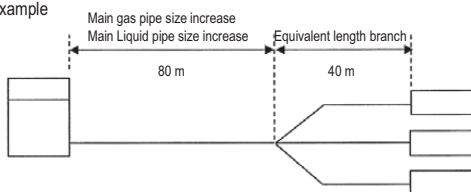

In the above case (Cooling) Overall equivalent length = 80 m x 1.0 + 40 m = 120 m
 (Heating) Overall equivalent length = 80 m x 0.5 + 40 m = 80 m
 The rate of change in cooling capacity when height difference = 0 is thus approximately 0.89
 heating capacity when height difference = 0 is thus approximately 1.0

3D079897A

5 Capacity tables

5 - 2 Capacity Correction Factor

RXYQQ16U
RXYQ16U
RYYQ16U
RYMQ16U

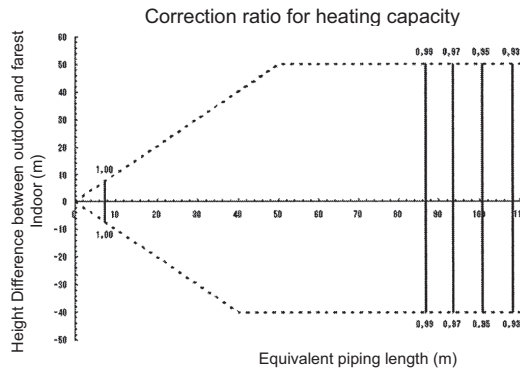
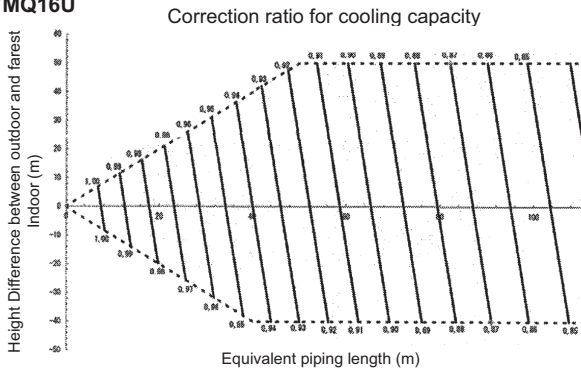

NOTES

- These figures illustrate the correction ratio for piping length in capacity for a standard indoor unit system at maximum load (with the thermostat set to maximum) under standard conditions. Moreover, under partial load conditions, there is only a minor deviation for the capacity correction ratio, shown in the above figures.
- With this outdoor unit, constant evaporating pressure control when cooling and constant condensing pressure control when heating is carried out.
- Method of calculating the capacity of the outdoor units
The maximum capacity of the system will be either the total capacity of the indoor units or the maximum capacity of the outdoor units as mentioned below, whichever is smaller.

Condition: Indoor connection ratio does not exceed 100%.

$$\text{Maximum capacity of outdoor units} = \text{Capacity of outdoor units from capacity table at the 100\% connection ratio} \times \text{Correction ratio of piping to furthest indoor}$$

Condition: Indoor connection ratio exceeds 100%.

$$\text{Maximum capacity of outdoor units} = \text{Capacity of outdoor units from capacity table at installed connection ratio} \times \text{Correction ratio of piping to furthest indoor}$$

- When level difference is 50 m or more (see installation manual and 3D079540 / 3D079543) and equivalent pipe length is 90 m or more, the diameter of the main gas and liquid pipes (outdoor unit - branch sections) must be increased. For new diameters, see below.

Model	Gas	Liquid
16 HP	31.8*	15.9

*If not available on site, do not increase. If not increased correction factor should be applied to the equivalent length (see note 6).

- When the pipe length after the first refrigerant branch kit is more than 40 m, pipe size between first and final branch kit must be increased (only for VRV DX indoor units; details see installation manual).

*Refer to the installation manual for allowed system setups and rules for dedicated indoor connection types.

Diameter of main pipes (standard size)

Model	Gas	Liquid
16 HP	28.6	12.7

- Equivalent length used in the above figures is based upon the following equivalent length

$$\text{Equivalent piping length} = \text{Equivalent length of main pipe} \times \text{Correction factor} + \text{Equivalent length of branch pipes}$$

Choose a correction factor from the following table. When cooling capacity is calculated: gas pipe size When heating capacity is calculated: liquid pipe size

	Correction factor	
	Standard size	Size increase
Cooling (gas pipe)	1.0	0.5
Heating (liquid pipe)	1.0	0.5

Example

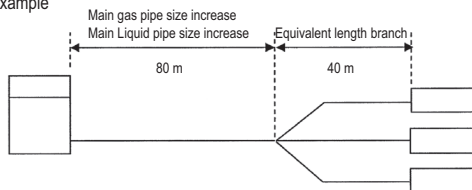

In the above case (Cooling) Overall equivalent length = 80 m x 1.0 + 40 m = 80 m
(Heating) Overall equivalent length = 80 m x 0.5 + 40 m = 80 m

The rate of change in cooling capacity when height difference = 0 is thus approximately 0.88
heating capacity when height difference = 0 is thus approximately 0.99

5 Capacity tables

5 - 2 Capacity Correction Factor

5

RXYQQ18,26,28,30,38,40,42,44U
 RXYQ18,26,28,30,38,40,42,44U
 RYYQ18,26,28,30,38,40,42,44U
 RYMQ18U

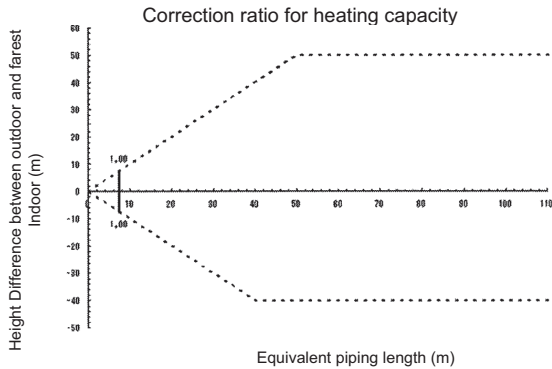
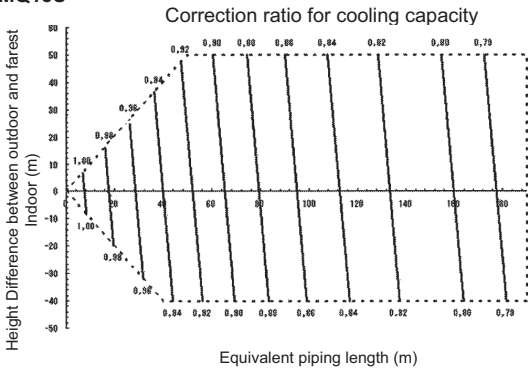

NOTES

- These figures illustrate the correction ratio for piping length in capacity for a standard indoor unit system at maximum load (with the thermostat set to maximum) under standard conditions. Moreover, under partial load conditions, there is only a minor deviation for the capacity correction ratio, shown in the above figures.
- With this outdoor unit, constant evaporating pressure control when cooling and constant condensing pressure control when heating is carried out.
- Method of calculating the capacity of the outdoor units
 The maximum capacity of the system will be either the total capacity of the indoor units or the maximum capacity of the outdoor units as mentioned below, whichever is smaller.

Condition: Indoor connection ratio does not exceed 100%.

$$\text{Maximum capacity of outdoor units} = \text{Capacity of outdoor units from capacity table at the 100\% connection ratio} \times \text{Correction ratio of piping to furthest indoor}$$

Condition: Indoor connection ratio exceeds 100%.

$$\text{Maximum capacity of outdoor units} = \text{Capacity of outdoor units from capacity table at installed connection ratio} \times \text{Correction ratio of piping to furthest indoor}$$

- When level difference is 50 m or more (see installation manual and 3D079540 / 3D079543) and equivalent pipe length is 90 m or more, the diameter of the main gas and liquid pipes (outdoor unit - branch sections) must be increased. For new diameters, see below.

Model	Gas	Liquid
18 HP	31.8*	19.1
26~30 HP	38.1*	22.2
38~44 HP	41.3	22.2

*If not available on site, do not increase. If not increased correction factor should be applied to the equivalent length (see note 6).

- When the pipe length after the first refrigerant branch kit is more than 40 m, pipe size between first and final branch kit must be increased (only for VRV DX indoor units; details see installation manual).

*Refer to the installation manual for allowed system setups and rules for dedicated indoor connection types.

Diameter of main pipes (standard size)

Model	Gas	Liquid
18 HP	28.6	15.9
26~30 HP	34.9	19.1
38~44 HP	41.3	19.1

- Equivalent length used in the above figures is based upon the following equivalent length

$$\text{Equivalent piping length} = \text{Equivalent length of main pipe} \times \text{Correction factor} + \text{Equivalent length of branch pipes}$$

Choose the correction factor from the following table. When cooling capacity is calculated: gas pipe size. When heating capacity is calculated: liquid pipe size

	Correction factor	
	Standard size	Size increase
Cooling (gas pipe)	1.0	0.5
Heating (liquid pipe)	1.0	0.5

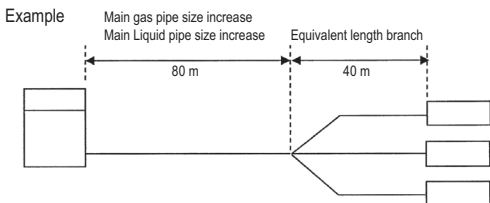

In the above case (for RXYQ38-44) (Cooling) Overall equivalent length = 80 m x 1.0 + 40 m = 120 m
 (Heating) Overall equivalent length = 80 m x 0.5 + 40 m = 80 m
 The rate of change in cooling capacity when height difference = 0 is thus approximately 0.83
 heating capacity when height difference = 0 is thus approximately 1.0

3D079897A

5 Capacity tables

5 - 2 Capacity Correction Factor

RXYQQ20,32,34U
 RXYQ20,32,34U
 RYYQ20,32,34U
 RYM20,32,34U

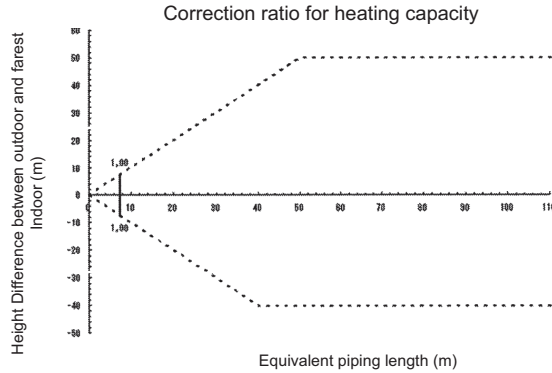
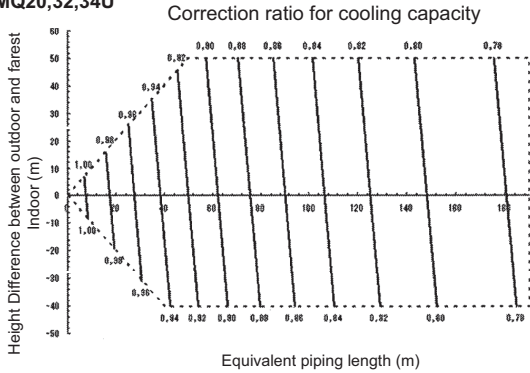

NOTES

- These figures illustrate the correction ratio for piping length in capacity for a standard indoor unit system at maximum load (with the thermostat set to maximum) under standard conditions. Moreover, under partial load conditions, there is only a minor deviation for the capacity correction ratio, shown in the above figures.
- With this outdoor unit, constant evaporating pressure control when cooling and constant condensing pressure control when heating is carried out.
- Method of calculating the capacity of the outdoor units
 The maximum capacity of the system will be either the total capacity of the indoor units or the maximum capacity of the outdoor units as mentioned below, whichever is smaller.

Condition: Indoor connection ratio does not exceed 100%.

$$\text{Maximum capacity of outdoor units} = \text{Capacity of outdoor units from capacity table at the 100\% connection ratio} \times \text{Correction ratio of piping to furthest indoor}$$

Condition: Indoor connection ratio exceeds 100%.

$$\text{Maximum capacity of outdoor units} = \text{Capacity of outdoor units from capacity table at installed connection ratio} \times \text{Correction ratio of piping to furthest indoor}$$

- When level difference is 50 m or more (see installation manual and 3D079540 / 3D079543) and equivalent pipe length is 90 m or more, the diameter of the main gas and liquid pipes (outdoor unit - branch sections) must be increased. For new diameters, see below.

Model	Gas	Liquid
20 HP	31.8*	19.1
32/34 HP	38.1*	22.2

*If not available on site, do not increase. If not increased correction factor should be applied to the equivalent length (see note 6).

- When the pipe length after the first refrigerant branch kit is more than 40 m, pipe size between first and final branch kit must be increased (only for VRV DX indoor units; details see installation manual).

*Refer to the installation manual for allowed system setups and rules for dedicated indoor connection types.

Diameter of main pipes (standard size)

Model	Gas	Liquid
20 HP	28.6	15.9
32/34 HP	34.9	19.1

- Equivalent length used in the above figures is based upon the following equivalent length

$$\text{Equivalent piping length} = \text{Equivalent length of main pipe} \times \text{Correction factor} + \text{Equivalent length of branch pipes}$$

Choose a correction factor from the following table. When cooling capacity is calculated: gas pipe size. When heating capacity is calculated: liquid pipe size

	Correction factor	
	Standard size	Size increase
Cooling (gas pipe)	1.0	0.5
Heating (liquid pipe)	1.0	0.5

Example

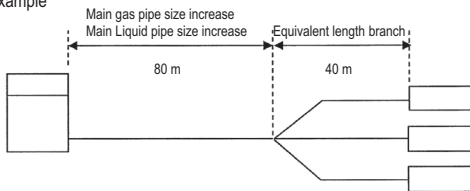

In the above case (Cooling) Overall equivalent length = 80 m x 0.5 + 40 m = 80 m
 (Heating) Overall equivalent length = 80 m x 0.5 + 40 m = 80 m
 The rate of change in cooling capacity when height difference = 0 is thus approximately 0.88
 heating capacity when height difference = 0 is thus approximately 1.0

5 Capacity tables

5 - 2 Capacity Correction Factor

5

RXYQQ22U
RXYQ22U
RYYQ22U
RYMQ22U

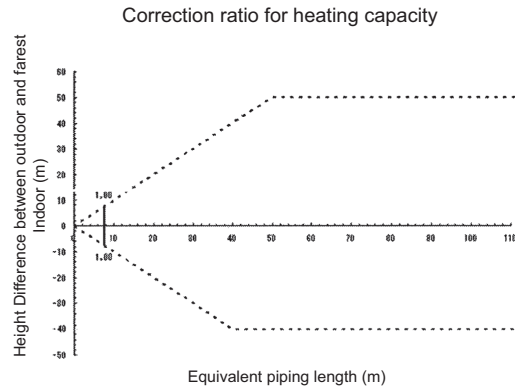
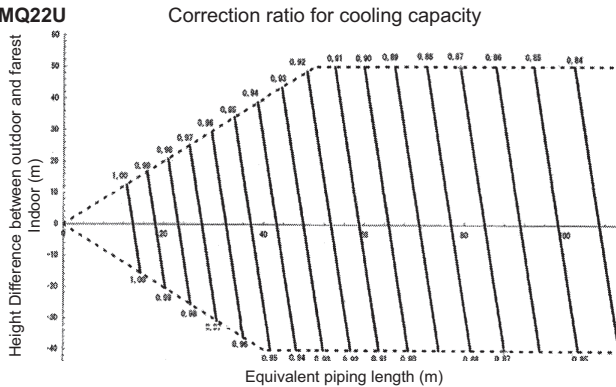

NOTES

- These figures illustrate the correction ratio for piping length in capacity for a standard indoor unit system at maximum load (with the thermostat set to maximum) under standard conditions. Moreover, under partial load conditions, there is only a minor deviation for the capacity correction ratio, shown in the above figures.
- With this outdoor unit, constant evaporating pressure control when cooling and constant condensing pressure control when heating is carried out.
- Method of calculating the capacity of the outdoor units
The maximum capacity of the system will be either the total capacity of the indoor units or the maximum capacity of the outdoor units as mentioned below, whichever is smaller.

Condition: Indoor connection ratio does not exceed 100%.

$$\text{Maximum capacity of outdoor units} = \text{Capacity of outdoor units from capacity table at the 100\% connection ratio} \times \text{Correction ratio of piping to furthest indoor}$$

Condition: Indoor connection ratio exceeds 100%.

$$\text{Maximum capacity of outdoor units} = \text{Capacity of outdoor units from capacity table at installed connection ratio} \times \text{Correction ratio of piping to furthest indoor}$$

- When level difference is 50 m or more (see installation manual and 3D079540 / 3D079543) and equivalent pipe length is 90 m or more, the diameter of the main gas and liquid pipes (outdoor unit - branch sections) must be increased. For new diameters, see below.

Model	Gas	Liquid
22 HP	31.8*	19.1

* If not available on site, do not increase, if not increased, no correction factor should be applied to the equivalent length (see note 6).

- When the pipe length after the first refrigerant branch kit is more than 40 m, pipe size between first and final branch kit must be increased (only for VRV DX indoor units; details see installation manual).

*Refer to the installation manual for allowed system setups and rules for dedicated indoor connection types.

Diameter of main pipes (standard size)

Model	Gas	Liquid
22 HP	28.6	15.9

- Equivalent length used in the above figures is based upon the following equivalent length

$$\text{Overall equivalent length} = \text{Equivalent length of main pipe} \times \text{Correction factor} + \text{Equivalent length of branch pipes}$$

Choose a correction factor from the following table. When cooling capacity is calculated: gas pipe size When heating capacity is calculated: liquid pipe size

	Correction factor	
	Standard size	Size increase
Cooling (gas pipe)	1.0	0.5
Heating (liquid pipe)	1.0	0.5

Example

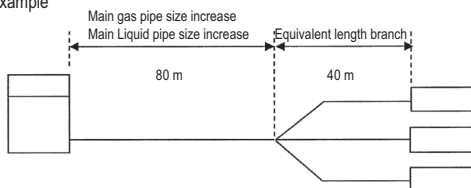

In the above case (Cooling) Overall equivalent length = 80 m x 0.5 + 40 m = 80 m
(Heating) Overall equivalent length = 80 m x 0.5 + 40 m = 80 m

The rate of change in cooling capacity when height difference = 0 is thus approximately 0.88
heating capacity when height difference = 0 is thus approximately 1.0

5 Capacity tables

5 - 2 Capacity Correction Factor

RYYQ46U

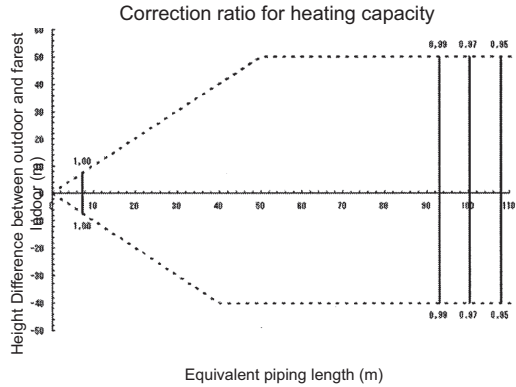
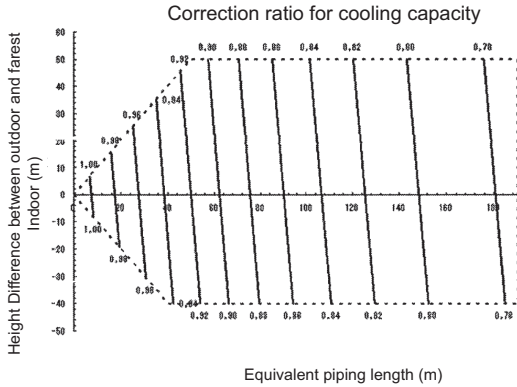

NOTES

- These figures illustrate the correction ratio for piping length in capacity for a standard indoor unit system at maximum load (with the thermostat set to maximum) under standard conditions. Moreover, under partial load conditions, there is only a minor deviation for the capacity correction ratio, shown in the above figures.
- With this outdoor unit, constant evaporating pressure control when cooling and constant condensing pressure control when heating is carried out.
- Method of calculating the capacity of the outdoor units
The maximum capacity of the system will be either the total capacity of the indoor units or the maximum capacity of the outdoor units as mentioned below, whichever is smaller.

Condition: Indoor connection ratio does not exceed 100%.

$$\text{Maximum capacity of outdoor units} = \text{Capacity of outdoor units from capacity table at the 100\% connection ratio} \times \text{Correction ratio of piping to furthest indoor}$$

Condition: Indoor connection ratio exceeds 100%.

$$\text{Maximum capacity of outdoor units} = \text{Capacity of outdoor units from capacity table at installed connection ratio} \times \text{Correction ratio of piping to furthest indoor}$$

- When level difference is 50 m or more (see installation manual and 3D079540 / 3D079543) and equivalent pipe length is 90 m or more, the diameter of the main gas and liquid pipes (outdoor unit - branch sections) must be increased. For new diameters, see below.

Model	Gas	Liquid
46 HP	41.3	22.2

- When the pipe length after the first refrigerant branch kit is more than 40 m, pipe size between first and final branch kit must be increased (only for VRV DX indoor units; details see installation manual).

*Refer to the installation manual for allowed system setups and rules for dedicated indoor connection types.

Diameter of main pipes (standard size)

Model	Gas	Liquid
46 HP	41.3	19.1

- Equivalent length used in the above figures is based upon the following equivalent length

$$\text{Equivalent piping length} = \text{Equivalent length of main pipe} \times \text{Correction factor} + \text{Equivalent length of branch pipes}$$

Choose a correction factor from the following table. When cooling capacity is calculated: gas pipe size. When heating capacity is calculated: liquid pipe size

	Correction factor	
	Standard size	Size increase
Cooling (gas pipe)	1.0	1.0
Heating (liquid pipe)	1.0	0.5

Example

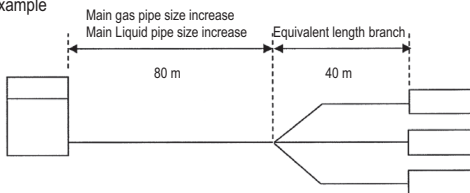

In the above case (Cooling) Overall equivalent length = 80 m x 1.0 + 40 m = 120 m
 (Heating) Overall equivalent length = 80 m x 0.5 + 40 m = 80 m
 The rate of change in cooling capacity when height difference = 0 is thus approximately 0.83
 heating capacity when height difference = 0 is thus approximately 1.0

5 Capacity tables

5 - 2 Capacity Correction Factor

5

RYYQ48U, RXYQQ48U, RYYQ48U

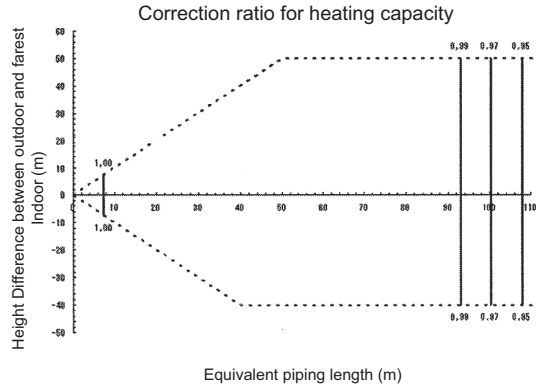
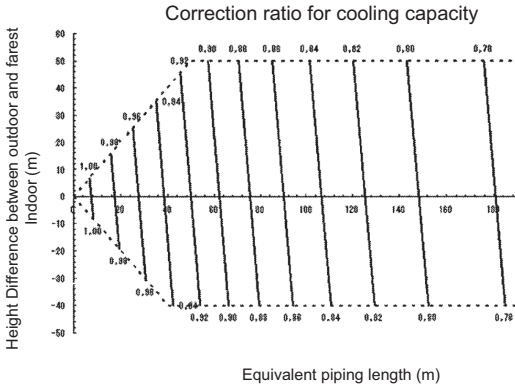

3D079897A

NOTES

- These figures illustrate the correction ratio for piping length in capacity for a standard indoor unit system at maximum load (with the thermostat set to maximum) under standard conditions. Moreover, under partial load conditions, there is only a minor deviation for the capacity correction ratio, shown in the above figures.
- With this outdoor unit, constant evaporating pressure control when cooling and constant condensing pressure control when heating is carried out.
- Method of calculating the capacity of the outdoor units
The maximum capacity of the system will be either the total capacity of the indoor units or the maximum capacity of the outdoor units as mentioned below, whichever is smaller.

Condition: Indoor connection ratio does not exceed 100%.

$$\text{Maximum capacity of outdoor units} = \text{Capacity of outdoor units from capacity table at the 100\% connection ratio} \times \text{Correction ratio of piping to furthest indoor}$$

Condition: Indoor connection ratio exceeds 100%.

$$\text{Maximum capacity of outdoor units} = \text{Capacity of outdoor units from capacity table at installed connection ratio} \times \text{Correction ratio of piping to furthest indoor}$$

- When level difference is 50 m or more (see installation manual and 3D079540 / 3D079543) and equivalent pipe length is 90 m or more, the diameter of the main gas and liquid pipes (outdoor unit - branch sections) must be increased. For new diameters, see below.

Model	Gas	Liquid
48 HP	41.3	22.2

- When the pipe length after the first refrigerant branch kit is more than 40 m, pipe size between first and final branch kit must be increased (only for VRV DX indoor units; details see installation manual).
*Refer to the installation manual for allowed system setups and rules for dedicated indoor connection types.

Diameter of main pipes (standard size)

Model	Gas	Liquid
48 HP	41.3	19.1

- Equivalent length used in the above figures is based upon the following equivalent length

$$\text{Equivalent piping length} = \text{Equivalent length of main pipe} \times \text{Correction factor} + \text{Equivalent length of branch pipes}$$

Choose a correction factor from the following table. When cooling capacity is calculated: gas pipe size When heating capacity is calculated: liquid pipe size

	Correction factor	
	Standard size	Size increase
Cooling (gas pipe)	1.0	0.5
Heating (liquid pipe)	1.0	0.5

Example

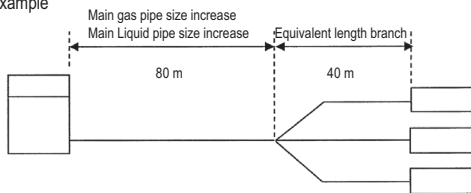

In the above case (Cooling) Overall equivalent length = 80 m x 1.0 + 40 m = 120 m
(Heating) Overall equivalent length = 80 m x 0.5 + 40 m = 80 m
The rate of change in cooling capacity when height difference = 0 is thus approximately 0.83
heating capacity when height difference = 0 is thus approximately 0.97

5 Capacity tables

5 - 2 Capacity Correction Factor

RYYQ50U, RXYQQ50U, RXYQ50U

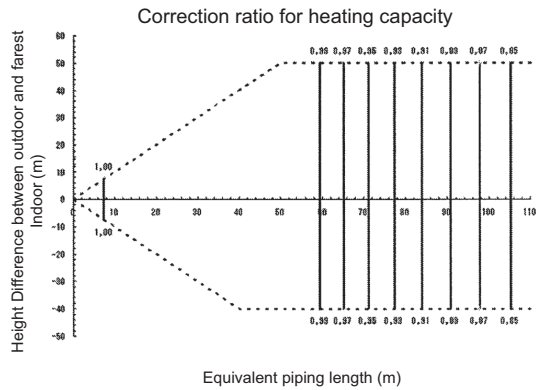
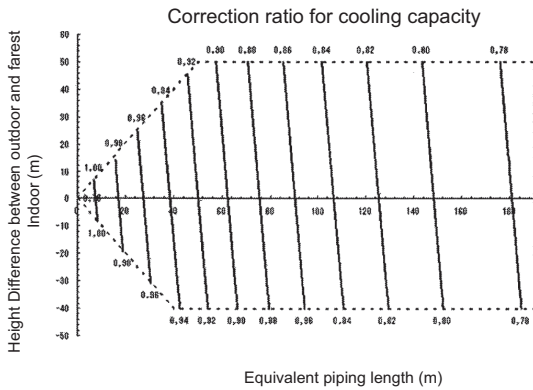

3D079897A

NOTES

- These figures illustrate the correction ratio for piping length in capacity for a standard indoor unit system at maximum load (with the thermostat set to maximum) under standard conditions. Moreover, under partial load conditions, there is only a minor deviation for the capacity correction ratio, shown in the above figures.
- With this outdoor unit, constant evaporating pressure control when cooling and constant condensing pressure control when heating is carried out.
- Method of calculating the capacity of the outdoor units
The maximum capacity of the system will be either the total capacity of the indoor units or the maximum capacity of the outdoor units as mentioned below, whichever is smaller.

Condition: Indoor connection ratio does not exceed 100%.

$$\text{Maximum capacity of outdoor units} = \text{Capacity of outdoor units from capacity table at the 100\% connection ratio} \times \text{Correction ratio of piping to furthest indoor}$$

Condition: Indoor connection ratio exceeds 100%.

$$\text{Maximum capacity of outdoor units} = \text{Capacity of outdoor units from capacity table at installed connection ratio} \times \text{Correction ratio of piping to furthest indoor}$$

- When level difference is 50 m or more (see installation manual and 3D079540 / 3D079543) and equivalent pipe length is 90 m or more, the diameter of the main gas and liquid pipes (outdoor unit - branch sections) must be increased. For new diameters, see below.

Model	Gas	Liquid
50 HP	41.3	22.2

- When the pipe length after the first refrigerant branch kit is more than 40 m, pipe size between first and final branch kit must be increased (only for VRV DX indoor units; details see installation manual).

*Refer to the installation manual for allowed system setups and rules for dedicated indoor connection types.

Diameter of main pipes (standard size)

Model	Gas	Liquid
50 HP	41.3	19.1

- Equivalent length used in the above figures is based upon the following equivalent length

$$\text{Equivalent piping length} = \text{Equivalent length of main pipe} \times \text{Correction factor} + \text{Equivalent length of branch pipes}$$

Choose a correction factor from the following table. When cooling capacity is calculated: gas pipe size When heating capacity is calculated: liquid pipe size

	Correction factor	
	Standard size	Size increase
Cooling (gas pipe)	1.0	0.5
Heating (liquid pipe)	1.0	0.5

Example

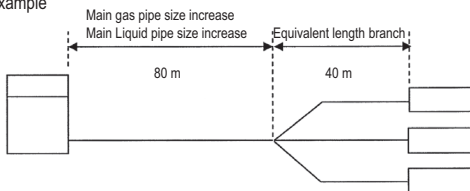

In the above case (Cooling) Overall equivalent length = 80 m x 1.0 + 40 m = 120 m
(Heating) Overall equivalent length = 80 m x 0.5 + 40 m = 80 m

The rate of change in cooling capacity when height difference = 0 is thus approximately 0.83
heating capacity when height difference = 0 is thus approximately 0.92

5 Capacity tables

5 - 2 Capacity Correction Factor

5

RYYQ52U, RXYQQ52U, RXYQ52U

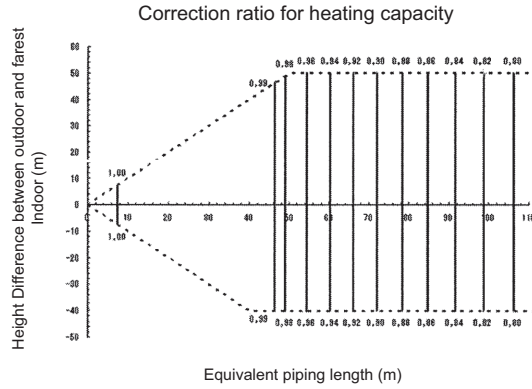
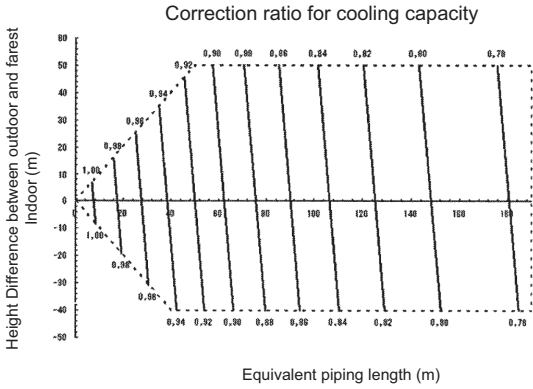

3D079897A

NOTES

- These figures illustrate the correction ratio for piping length in capacity for a standard indoor unit system at maximum load (with the thermostat set to maximum) under standard conditions. Moreover, under partial load conditions, there is only a minor deviation for the capacity correction ratio, shown in the above figures.
- With this outdoor unit, constant evaporating pressure control when cooling and constant condensing pressure control when heating is carried out.
- Method of calculating the capacity of the outdoor units
The maximum capacity of the system will be either the total capacity of the indoor units or the maximum capacity of the outdoor units as mentioned below, whichever is smaller.

Condition: Indoor connection ratio does not exceed 100%.

$$\text{Maximum capacity of outdoor units} = \text{Capacity of outdoor units from capacity table at the 100\% connection ratio} \times \text{Correction ratio of piping to furthest indoor}$$

Condition: Indoor connection ratio exceeds 100%.

$$\text{Maximum capacity of outdoor units} = \text{Capacity of outdoor units from capacity table at installed connection ratio} \times \text{Correction ratio of piping to furthest indoor}$$

- When level difference is 50 m or more (see installation manual and 3D079540 / 3D079543) and equivalent pipe length is 90 m or more, the diameter of the main gas and liquid pipes (outdoor unit - branch sections) must be increased. For new diameters, see below.

Model	Gas	Liquid
52 HP	41.3	22.2

- When the pipe length after the first refrigerant branch kit is more than 40 m, pipe size between first and final branch kit must be increased (only for VRV DX indoor units; details see installation manual).

*Refer to the installation manual for allowed system setups and rules for dedicated indoor connection types.

Diameter of main pipes (standard size)

Model	Gas	Liquid
52 HP	41.3	19.1

- Equivalent length used in the above figures is based upon the following equivalent length

$$\text{Equivalent piping length} = \text{Equivalent length of main pipe} \times \text{Correction factor} + \text{Equivalent length of branch pipes}$$

Choose a correction factor from the following table. When cooling capacity is calculated: gas pipe size When heating capacity is calculated: liquid pipe size

	Correction factor	
	Standard size	Size increase
Cooling (gas pipe)	1.0	0.5
Heating (liquid pipe)	1.0	0.5

Example

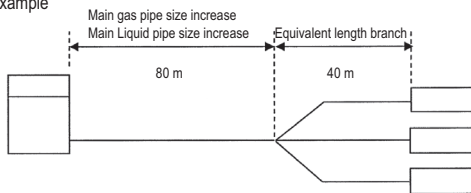

In the above case (Cooling) Overall equivalent length = 80 m x 1.0 + 40 m = 120 m
(Heating) Overall equivalent length = 80 m x 0.5 + 40 m = 80 m
The rate of change in cooling capacity when height difference = 0 is thus approximately 0.83
heating capacity when height difference = 0 is thus approximately 0.88

5 Capacity tables

5 - 2 Capacity Correction Factor

RYYQ54U, RXYQQ54U, RXYQ54U

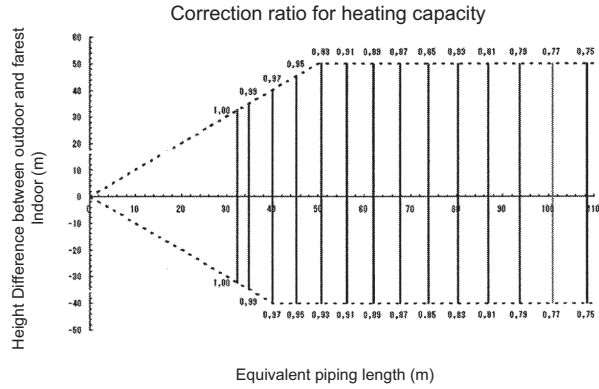
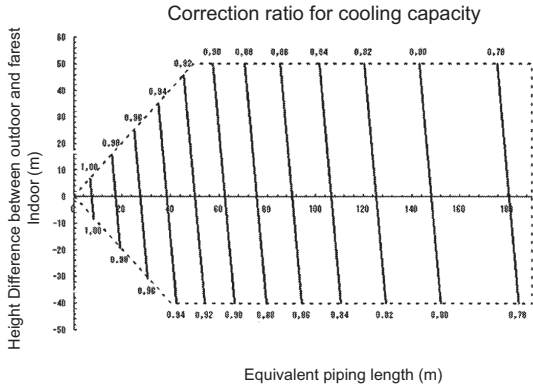

3D079897A

NOTES

- These figures illustrate the correction ratio for piping length in capacity for a standard indoor unit system at maximum load (with the thermostat set to maximum) under standard conditions. Moreover, under partial load conditions, there is only a minor deviation for the capacity correction ratio, shown in the above figures.
- With this outdoor unit, constant evaporating pressure control when cooling and constant condensing pressure control when heating is carried out.
- Method of calculating the capacity of the outdoor units
The maximum capacity of the system will be either the total capacity of the indoor units or the maximum capacity of the outdoor units as mentioned below, whichever is smaller.

Condition: Indoor connection ratio does not exceed 100%.

$$\text{Maximum capacity of outdoor units} = \text{Capacity of outdoor units from capacity table at the 100\% connection ratio} \times \text{Correction ratio of piping to furthest indoor}$$

Condition: Indoor connection ratio exceeds 100%.

$$\text{Maximum capacity of outdoor units} = \text{Capacity of outdoor units from capacity table at installed connection ratio} \times \text{Correction ratio of piping to furthest indoor}$$

- When level difference is 50 m or more (see installation manual and 3D079540 / 3D079543) and equivalent pipe length is 90 m or more, the diameter of the main gas and liquid pipes (outdoor unit - branch sections) must be increased. For new diameters, see below.

Model	Gas	Liquid
54 HP	41.3	22.2

- When the pipe length after the first refrigerant branch kit is more than 40 m, pipe size between first and final branch kit must be increased (only for VRV DX indoor units; details see installation manual).
*Refer to the installation manual for allowed system setups and rules for dedicated indoor connection types.

Diameter of main pipes (standard size)

Model	Gas	Liquid
54 HP	41.3	19.1

- Equivalent length used in the above figures is based upon the following equivalent length

$$\text{Equivalent piping length} = \text{Equivalent length of main pipe} \times \text{Correction factor} + \text{Equivalent length of branch pipes}$$

Choose a correction factor from the following table. When cooling capacity is calculated: gas pipe size When heating capacity is calculated: liquid pipe size

	Correction factor	
	Standard size	Size increase
Cooling (gas pipe)	1.0	0.5
Heating (liquid pipe)	1.0	0.5

Example

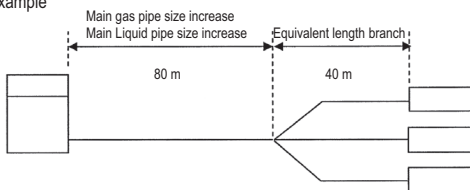

In the above case (Cooling) Overall equivalent length = 80 m x 1.0 + 40 m = 120 m
(Heating) Overall equivalent length = 80 m x 0.5 + 40 m = 80 m

The rate of change in cooling capacity when height difference = 0 is thus approximately 0.83
heating capacity when height difference = 0 is thus approximately 0.83

7 Centre of gravity

7 - 1 Centre of Gravity

RXYQQ8-12U
 RXYQ8-12U
 RXYTQ8U
 RYYQ8-12U
 RYMQ8-12U

Unit	AA	AB	AC
RYYQ8-12U	328	366	565
REM05U / REYQ8-12U			
RYMQ8-12U	354	443	565
RXYQ8-12U	339	448	565
RXYQQ8-12U			
RXYTQ8U			

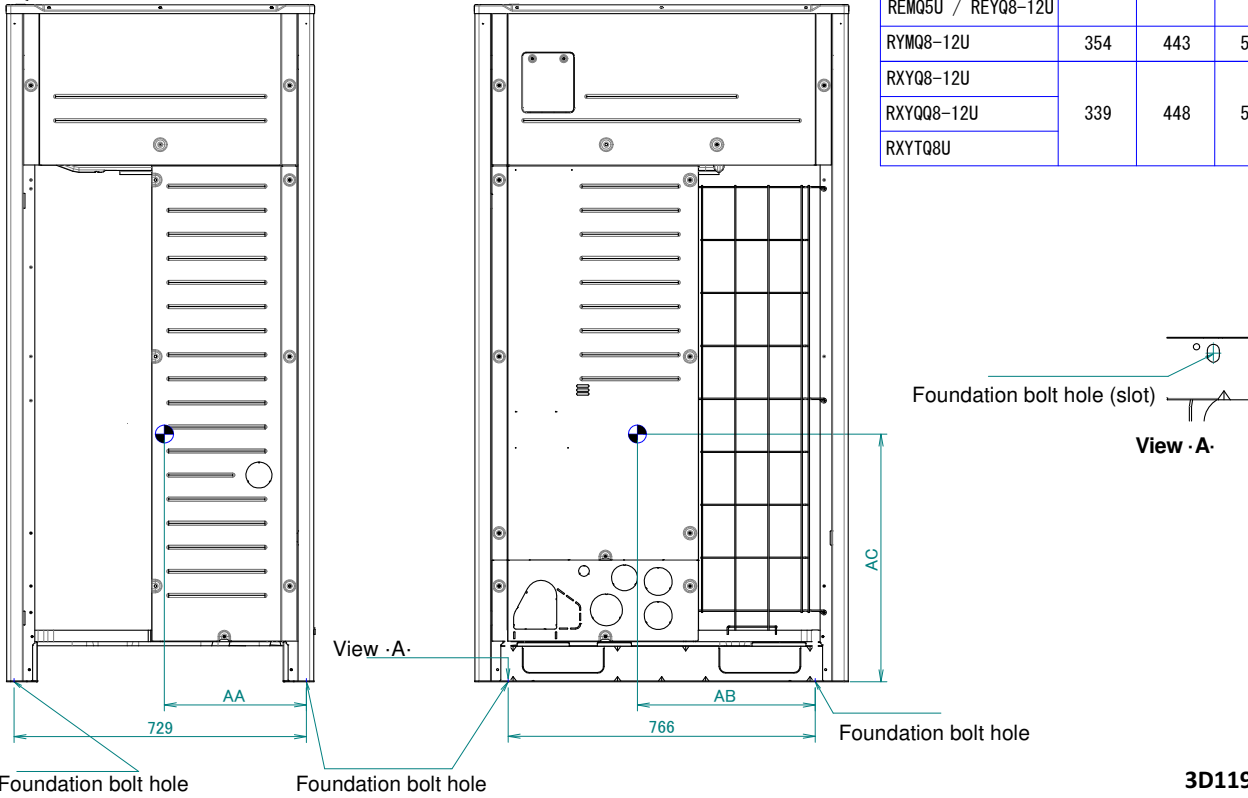

3D119703

RXYQQ14-20U
 RXYQ14-20U
 RXYTQ10-16U
 RYYQ14-20U
 RYMQ14-20U

Unit	AA	AB	AC
RYYQ14-20U	334	470	610
REYQ14-20U	334	470	610
RYMQ14-20U	360	569	610
RXYQ (Q) 14-20U	345	575	610
RXYTQ10-12U	350	610	810
RXYTQ14-16U	351	565	610

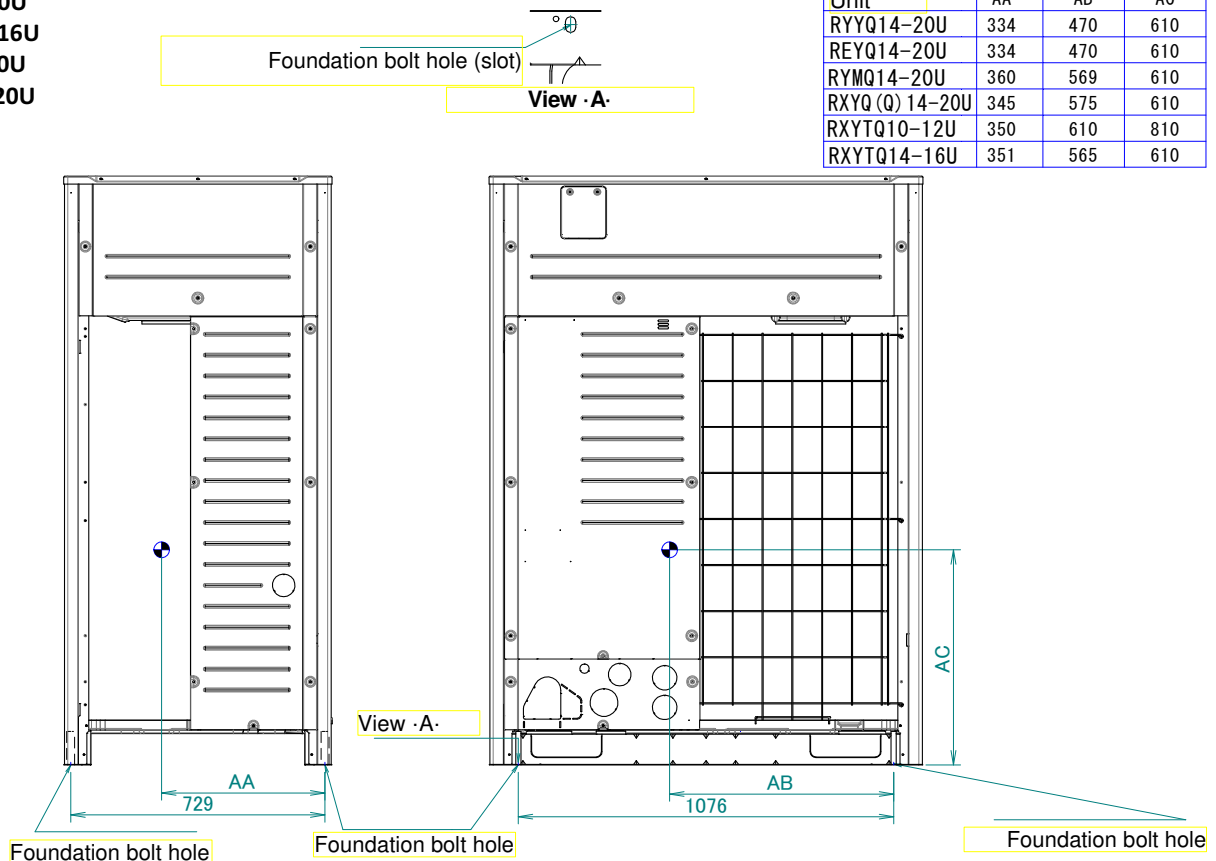

3D119704









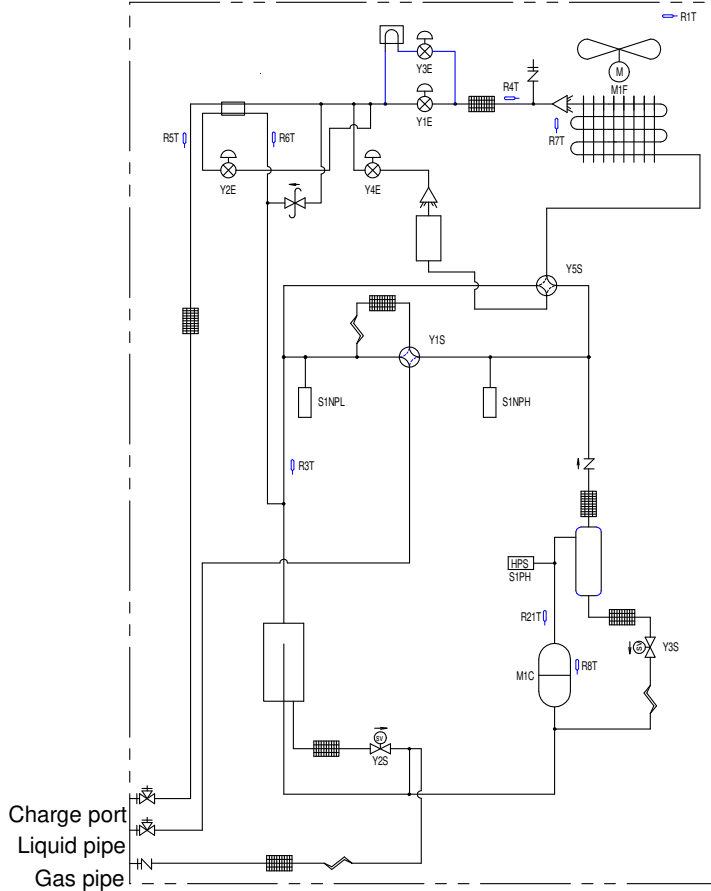













8 Piping diagrams

8 - 1 Piping Diagrams

8

RYYQ8-12U









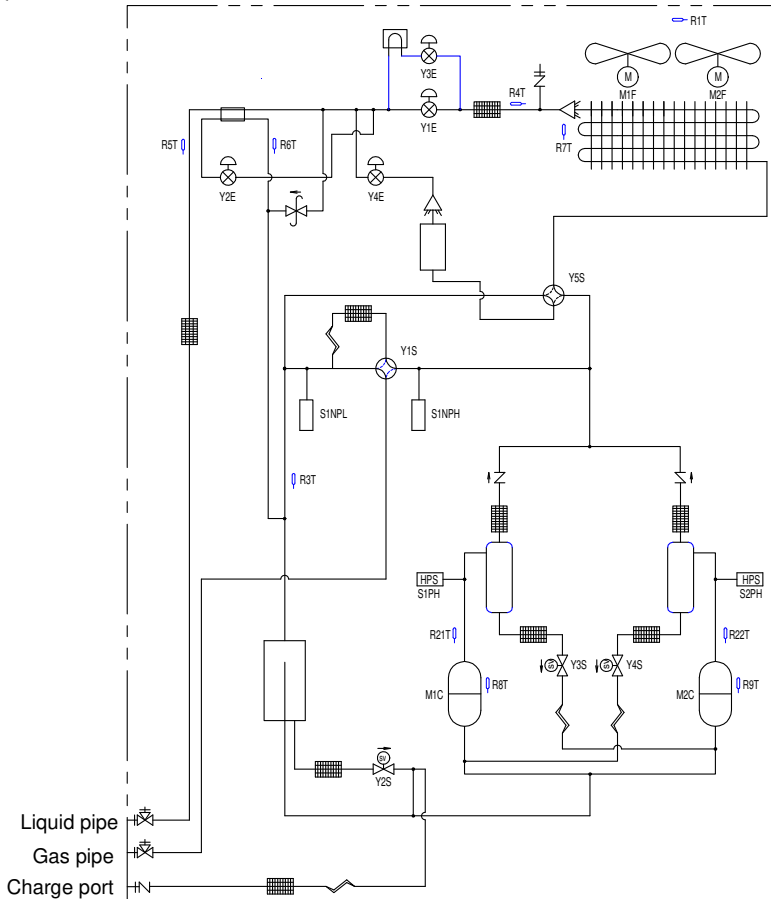















-  Charge port / Service port
-  Stop valve
-  Filter
-  Check valve
-  Pressure relief valve
-  Thermistor
-  Heat sink (PCB)
-  Capillary tube
-  Expansion valve
-  4-way valve
-  Propeller fan
-  High pressure switch
-  Low pressure sensor
-  High pressure sensor
-  Accumulator
-  Heat exchanger
-  Compressor
-  Oil separator
-  Double tube heat exchanger
-  Distributor
-  Solenoid valve
-  Heat storage vessel

3D118183

RYYQ14-20U



-  Charge port / Service port
-  Stop valve
-  Filter
-  Check valve
-  Pressure relief valve
-  Thermistor
-  Heat sink (PCB)
-  Capillary tube
-  Expansion valve
-  4-way valve
-  Propeller fan
-  High pressure switch
-  Low pressure sensor
-  High pressure sensor
-  Accumulator
-  Heat exchanger
-  Compressor
-  Oil separator
-  Double tube heat exchanger
-  Distributor
-  Solenoid valve
-  Heat storage vessel









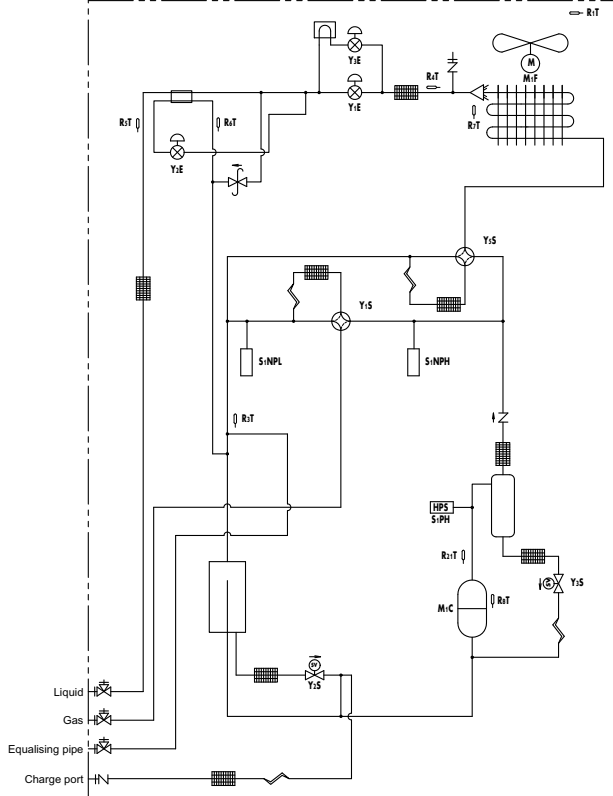











3D118184

8 Piping diagrams

8 - 1 Piping Diagrams

RYMQ8-12U









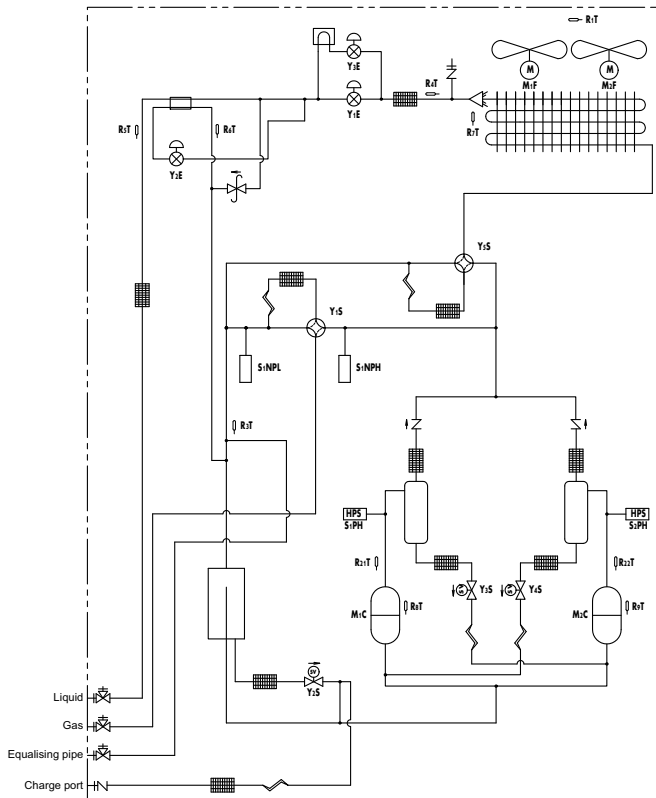













-  Charge port / Service port
-  Stop valve
-  Filter
-  Check valve
-  Pressure relief valve
-  Thermistor
-  Heat sink (PCB)
-  Capillary tube
-  Expansion valve
-  4-way valve
-  Propeller fan
-  High pressure switch
-  Low pressure sensor
-  High pressure sensor
-  Accumulator
-  Heat exchanger
-  Compressor
-  Oil separator
-  Double tube heat exchanger
-  Distributor
-  Solenoid valve

3D118185

RYMQ14-20U



-  Charge port / Service port
-  Stop valve
-  Filter
-  Check valve
-  Pressure relief valve
-  Thermistor
-  Heat sink (PCB)
-  Capillary tube
-  Expansion valve
-  4-way valve
-  Propeller fan
-  High pressure switch
-  Low pressure sensor
-  High pressure sensor
-  Accumulator
-  Heat exchanger
-  Compressor
-  Oil separator
-  Double tube heat exchanger
-  Distributor
-  Solenoid valve

3D118186

9 Wiring diagrams

9 - 1 Wiring Diagrams - Single Phase

9

RXYQ8-12U
 RXYTQ8UYF
 RYYQ8-12U
 RYMQ8-12U

Power supply 3N~ 380-415V 50Hz
 3N~ 380V 60Hz

Wiring diagram

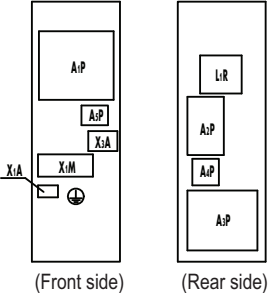
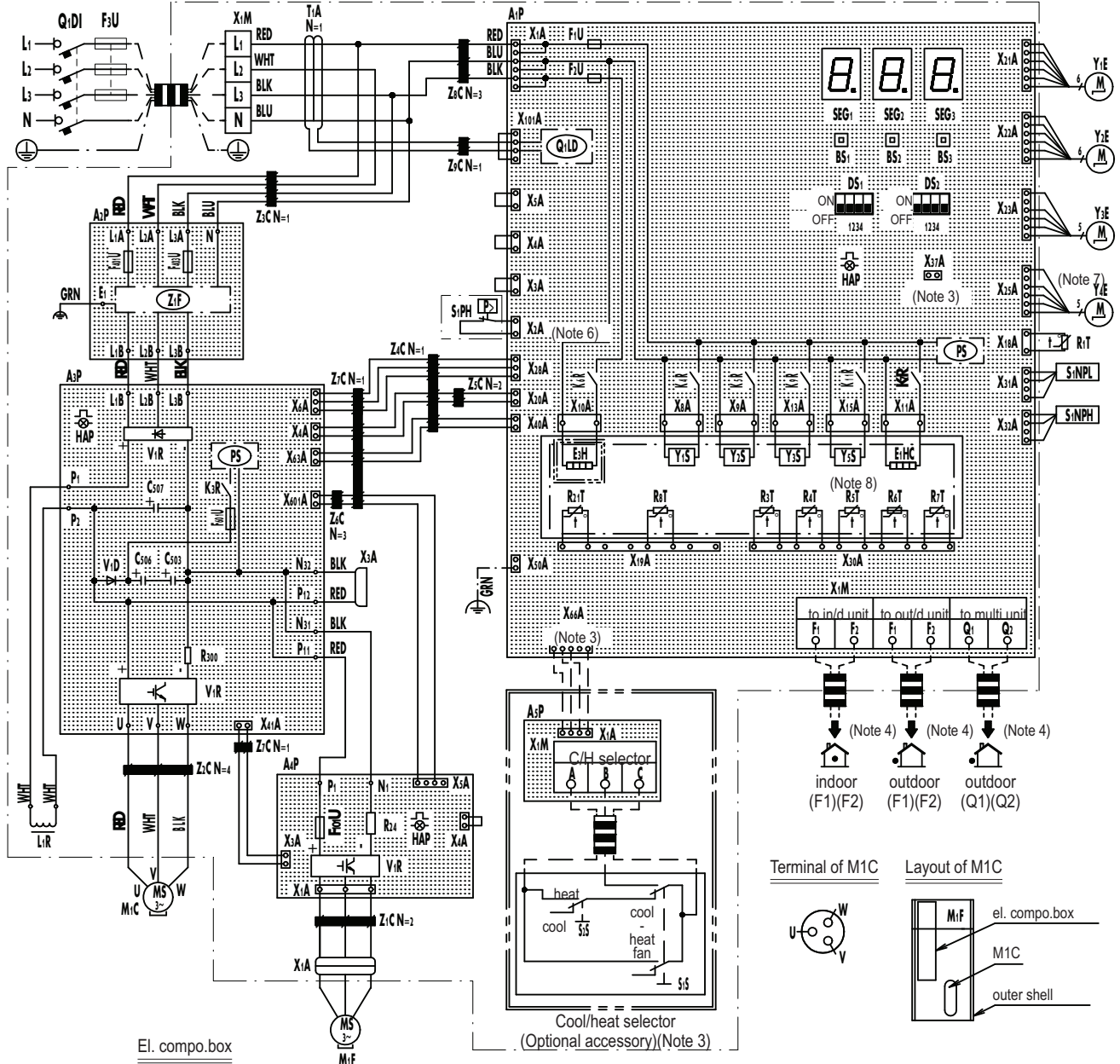

8,10,12 class

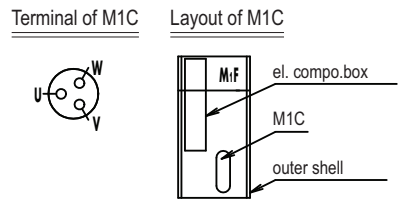

2D117534

9 Wiring diagrams

9 - 1 Wiring Diagrams - Single Phase

RXYQ8-12U
RXYTQ8UYF
RYYQ8-12U
RYMQ8-12U

A1P	Printed Circuit Board (Main)	R3T	Thermistor (Accumulator)
A2P	Printed Circuit Board (Noise Filter)	R4T	Thermistor (Heat Exc,Liq,Pipe)
A3P	Printed Circuit Board (Inv)	R5T	Thermistor (Subcool,Liq,Pipe)
A4P	Printed Circuit Board (Fan)	R6T	Thermistor (Heat Exc,Gas Pipe)
A5P	Printed Circuit Board (ABC I/P)(Option)	R7T	Thermistor (Heat Exc,Deicer)
BS1~3 (A1P)	Push Button Switch (Mode,Set,Return)	R8T	Thermistor (M1C body)
C503,C506,C507 (A3P)	Capacitor	R21T	Thermistor (M1C discharge)
DS1,DS2 (A1P)	DIP Switch	S1NPH	Pressure Sensor (High)
E1HC	Crankcase Heater	S1NPL	Pressure Sensor (Low)
E3H	Drainpan Heater (Option)	S1PH	Pressure Switch (Disch)
F1U,F2U (A1P)	Fuse (T,3,15A,250V)	SEG1~SEG3 (A1P)	7-Segment Display
F3U	Field Fuse	T1A	Current Sensor
F101U (A4P)	Fuse	V1D (A3P)	Diode
F401U,F403U (A2P)	Fuse	V1R (A3P,A4P)	Power Module
F601U (A3P)	Fuse	X*A	Connector
HAP (A1P,A3P, A4P)	Pilotlamp (Service Monitor-Green)	X1M (A1P)	Terminal Block (Control)
K3R (A3P)	Magnetic Relay	X1M (A5P)	Terminal Block (Power Supply)(Option)
K4R (A1P)	Magnetic Relay (Y1S)	Y1E	Electronic Expansion Valve(Main)
K5R (A1P)	Magnetic Relay (Y2S)	Y2E	Electronic Expansion Valve (Injection)
K6R (A1P)	Magnetic Relay (E3H)	Y3E	Electronic Expansion Valve (Refrigerant Jacket)
K7R (A1P)	Magnetic Relay (E1HC)	Y4E	Electronic Expansion Valve (Storage Vessel)
K9R (A1P)	Magnetic Relay (Y3S)	Y1S	Solenoid Valve (Main)
K11R (A1P)	Magnetic Relay (Y5S)	Y2S	Solenoid Valve (Accumulator Oil Return)
L1R	Reactor	Y3S	Solenoid Valve (Oil1)
M1C	Motor (Compressor)	Y5S	Solenoid Valve (Sub)
M1F	Motor (Fan)	Z*C	Noise Filter (Ferrite Core)
PS (A1P,A3P)	Switching Power Supply	Z*F (A2P)	Noise Filter (With Surge Absorber)
Q1DI	Field Earth Leakage Breaker	Connector For Optional Accessories	
Q1LD (A1P)	Field Earth Current Detector	X10A	Connector (Drainpan Heater)
R24 (A4P)	Resistor (Current Sensor)	X37A	Connector (Power Adapter)
R300 (A3P)	Resistor (Current Sensor)	X66A	Connector (Remote Switching Cool/Heat Selector)
R1T	Thermistor (Air)		

NOTES

1. This wiring diagram applies only to the outdoor unit.
2. :field wiring, :terminal block, :connector, :terminal, : protective earth (screw), : functional earth, : earth wiring, : field supply, : PCB, : switch box, : option
3. When using the optional adapter, refer to the installation manual of the optional adapter.
4. For connection wiring to indoor-outdoor transmission F1-F2, outdoor-outdoor transmission F1-F2, outdoor-multi transmission Q1-Q2, refer to the installation manual.
5. How to use BS1~3 switch. Refer to "service precaution" label on el. compo. box cover.
6. When operating, don't shortcircuit the protection devices (S1PH).
7. Only for RYYQ model.
8. Only for RYYQ/RYMQ model.
9. Colors: BLK: Black, RED: Red, BLU: Blue, WHT: White, GRN: Green.

2D117534

9 Wiring diagrams

9 - 1 Wiring Diagrams - Single Phase

9

RXYQ14-20U
 RXYTQ14-16U
 RYYQ14-20U
 RYMQ14-20U

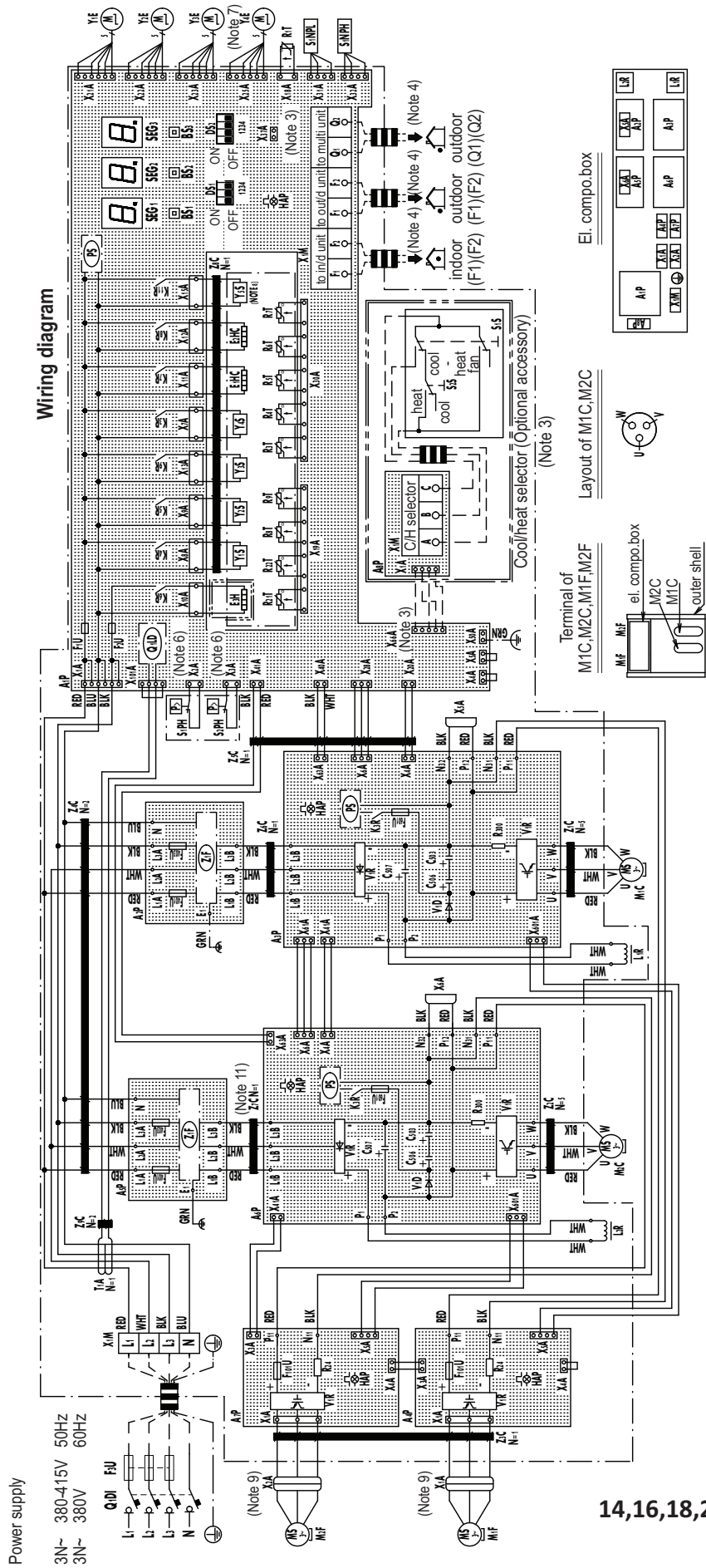

14,16,18,20 class

2D117536B

9 Wiring diagrams

9 - 1 Wiring Diagrams - Single Phase

RXYQ14-20U
RXYTQ14-16U
RYYQ14-20U
RYMQ14-20U

A1P	Printed Circuit Board (Main)	R3T	Thermistor (Accumulator)
A2P,A5P	Printed Circuit Board (Noise Filter)	R4T	Thermistor (Heat Exc,Liq,Pipe)
A3P,A6P	Printed Circuit Board (Inv)	R5T	Thermistor (Subcool,Liq,Pipe)
A4P,A7P	Printed Circuit Board (Fan)	R6T	Thermistor (Heat Exc,Gas Pipe)
A8P	Printed Circuit Board (ABC I/P)	R7T	Thermistor (Heat Exc,Deicer)
C503,C506,C507 (A3P,A6P)	Capacitor	R8T,R9T	Thermistor (M1C ,M2C body)
DS1,DS2 (A1P)	DIP Switch	R21T,R22T	Thermistor (M1C ,M2C discharge)
E1HC,E2HC	Crankcase Heater	S1NPH	Pressure Sensor (High)
E3H	Drainpan Heater (Option)	S1NPL	Pressure Sensor (Low)
F1U,F2U (A1P)	Fuse (T,3,15A,250V)	S1PH,S2PH	Pressure Switch (Disch)
F3U	Field Fuse	SEG1~SEG3 (A1P)	7-Segment Display
F101U (A4P,A7P)	Fuse	T1A	Current Sensor
F401U,F403U (A2P,A5P)	Fuse	V1D (A3P,A6P)	Diode
F601U (A3P,A6P)	Fuse	V1R (A3P,A4P,A6P,A7P)	Power Module
HAP (A1P,A3P,A4P,A6P,A7P)	Pilotlamp (Service Monitor-Green)	X*A	Connector
K3R (A3P,A6P)	Magnetic Relay	X1M (A1P)	Terminal Block (Control)
K3R (A1P)	Magnetic Relay (Y4S)	X1M (A8P)	Terminal Block (Power Supply)
K4R (A1P)	Magnetic Relay (Y1S)	Y1E	Electronic Expansion Valve(Main)
K5R (A1P)	Magnetic Relay (Y2S)	Y2E	Electronic Expansion Valve (Injection)
K6R (A1P)	Magnetic Relay (E3H)	Y3E	Electronic Expansion Valve (Refrigerant Jacket)
K7R (A1P)	Magnetic Relay (E1HC)	Y4E	Electronic Expansion Valve (Storage Vessel) (Note 7)
K8R (A1P)	Magnetic Relay (E2HC)	Y1S	Solenoid Valve (Main)
K9R (A1P)	Magnetic Relay (Y3S)	Y2S	Solenoid Valve (Accumulator Oil Return)
K11R (A1P)	Magnetic Relay (Y5S)	Y3S	Solenoid Valve (Oil1)
L1R,L2R	Reactor	Y3S	Solenoid Valve (Oil2)
M1C,M2C	Motor (Compressor)	Y5S	Solenoid Valve (Sub) (Note 8)
M1F,M2F	Motor (Fan)	Z*C	Noise Filter (Ferrite Core)
PS (A1P,A3P,A6P)	Switching Power Supply	Z*F (A2P,A5P)	Noise Filter (With Surge Absorber)
Q1DI	Field Earth Leakage Breaker	Connector For Optional Accessories	
Q1LD (A1P)	Field Earth Current Detector	X10A	Connector (Drainpan Heater)
R24 (A4P,A7P)	Resistor (Current Sensor)	X37A	Connector (Power Adapter)
R300 (A3P,A6P)	Resistor (Current Sensor)	X66A	Connector (Remote Switching Cool/Heat Selector)
R1T	Thermistor (Air)		

NOTES

1. This wiring diagram applies only to the outdoor unit.
2. :field wiring, : terminal block, : connector, : terminal, : protective earth (screw), : functional earth, : earth wiring, : field supply, : PCB, : switch box, : option
3. When using the optional adapter, refer to the installation manual of the optional adapter.
4. For connection wiring to indoor-outdoor transmission F1-F2, outdoor-outdoor transmission F1-F2, outdoor-multi transmission Q1-Q2, refer to the installation manual.
5. How to use BS1~3 switch. Refer to "service precaution" label on el. compo. box cover.
6. When operating, don't shortcircuit the protection devices (S1PH, S2PH).
7. Only for RYYQ model.
8. Only for RYYQ/RYMQ model.
9. Connector x1a (m1f) is red, connector x2a (m2f) is white.
10. Colors: BLK: Black, RED: Red, BLU: Blue, WHT: White, GRN: Green.
11. Only for 14,16 class

2D117536B

10 External connection diagrams

10 - 1 External Connection Diagrams

10

RXYQQ8-20U
 RXYQ8-20U
 RYYQ8-20U
 RYMQ8-20U
 RXYTQ8-16UYF

Notes

1. All wiring, components and materials to be procured on-site must comply with the applicable legislation.
2. Use copper conductors only
3. For details, refer to the wiring diagram attached to the outdoor unit.
4. Install a circuit breaker for safety.
5. All field wiring and components must be provided by an authorised electrician.
6. Unit has to be grounded in compliance with the applicable legislation.
7. The wiring shown is a general points-of-connection guide and is not intended to include all details for a specific installation.
8. Make sure to install the switch and the fuse to the power line of each equipment.
9. Install a main switch to control the multiple power sources that the various components of the system make use of.
10. If there exists the possibility of reversed phase, loose phase or momentary blackout, or if the power goes on and off while the product is operating, attach a reversed phase protection circuit locally.
11. Running the product in reversed phase may break the compressor and other parts.
12. Install an earth leakage circuit breaker.

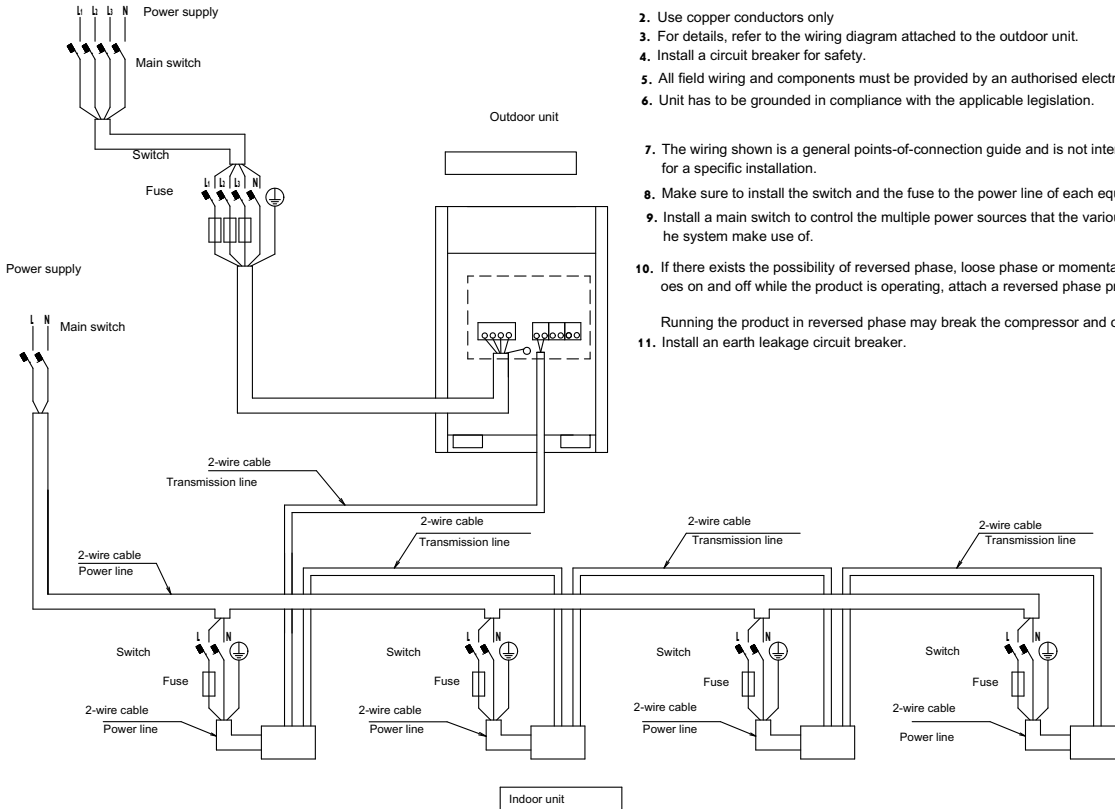

3D119317

RXYQQ8-20U
 RXYQ8-20U
 RXYTQ8-16U
 RYYQ8-20U
 RYMQ8-26U

Notes

1. All wiring, components and materials to be procured on-site must comply with the applicable legislation.
2. Use copper conductors only
3. For details, refer to the wiring diagram attached to the outdoor unit.
4. Install a circuit breaker for safety.
5. All field wiring and components must be provided by an authorised electrician.
6. Unit has to be grounded in compliance with the applicable legislation.
7. The wiring shown is a general points-of-connection guide and is not intended to include all details for a specific installation.
8. Make sure to install the switch and the fuse to the power line of each equipment.
9. Install a main switch to control the multiple power sources that the various components of the system make use of.
10. The capacity of UNIT1 must be larger than that of UNIT2 when the power source is connected in series between the units.
11. If there exists the possibility of reversed phase, loose phase or momentary blackout, or if the power goes on and off while the product is operating, attach a reversed phase protection circuit locally.
12. Running the product in reversed phase may break the compressor and other parts.
13. Install an earth leakage circuit breaker.

< Power source is supplied to each outdoor unit individually. >

< Power source is connected in series between the units. >

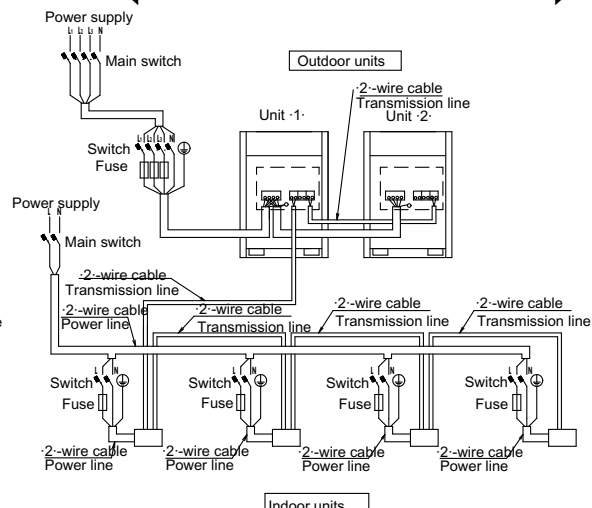
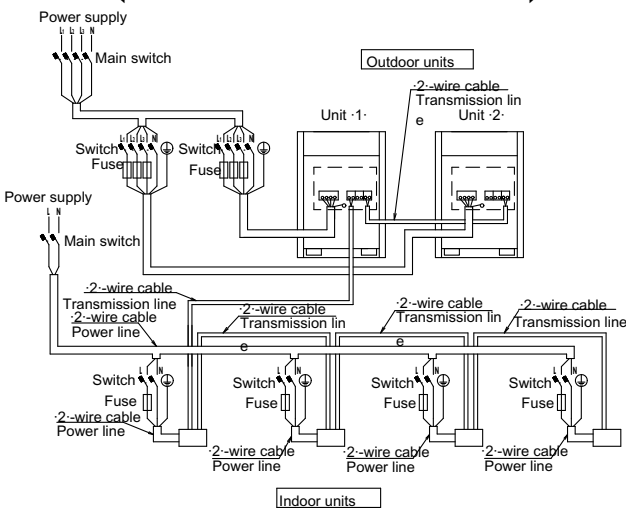

3D119316

10 External connection diagrams

10 - 1 External Connection Diagrams

RXYQ8-20U
 RXYQ8-20U
 RXYT8-16UYF
 RYYQ8-20U
 RYM8-20U
 RXYT8-16U

Notes

- All wiring, components and materials to be procured on-site must comply with the applicable legislation.
- Use copper conductors only
- For details, refer to the wiring diagram attached to the outdoor unit.
- Install a circuit breaker for safety.
- All field wiring and components must be provided by an authorised electrician.
- Unit has to be grounded in compliance with the applicable legislation.
- The wiring shown is a general points-of-connection guide and is not intended to include all details for a specific installation.
- Make sure to install the switch and the fuse to the power line of each equipment.
- Install a main switch to control the multiple power sources that the various components of the system make use of.
- The capacity of UNIT1 must be larger than that of UNIT2 when the power source is connected in series between the units.
 The capacity of UNIT 2 must be larger than that of UNIT3 when the power source is connected in series between the units.
- If there exists the possibility of reversed phase, loose phase or momentary blackout, or if the power goes on and off while the product is operating, attach a reversed phase protection circuit locally.
 Running the product in reversed phase may break the compressor and other parts.
- Install an earth leakage circuit breaker.

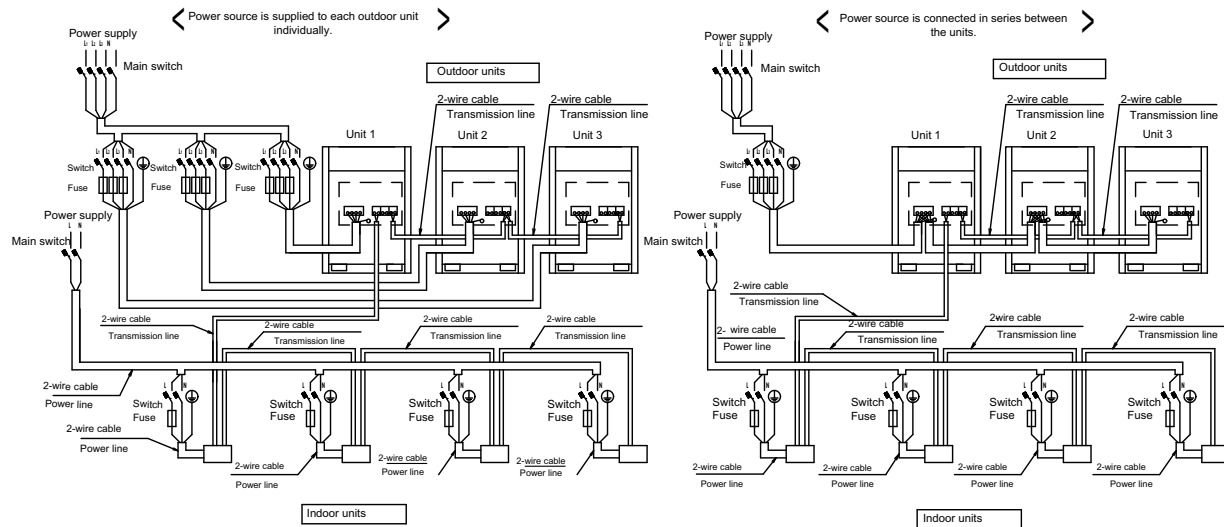

3D119200

11 Sound data

11 - 1 Sound Power Spectrum

11

REMQ5U
REYQ8U
RXYQQ8U
RXYQ8U
RXYTQ8UYF
RYYQ8U
RYMQ8U

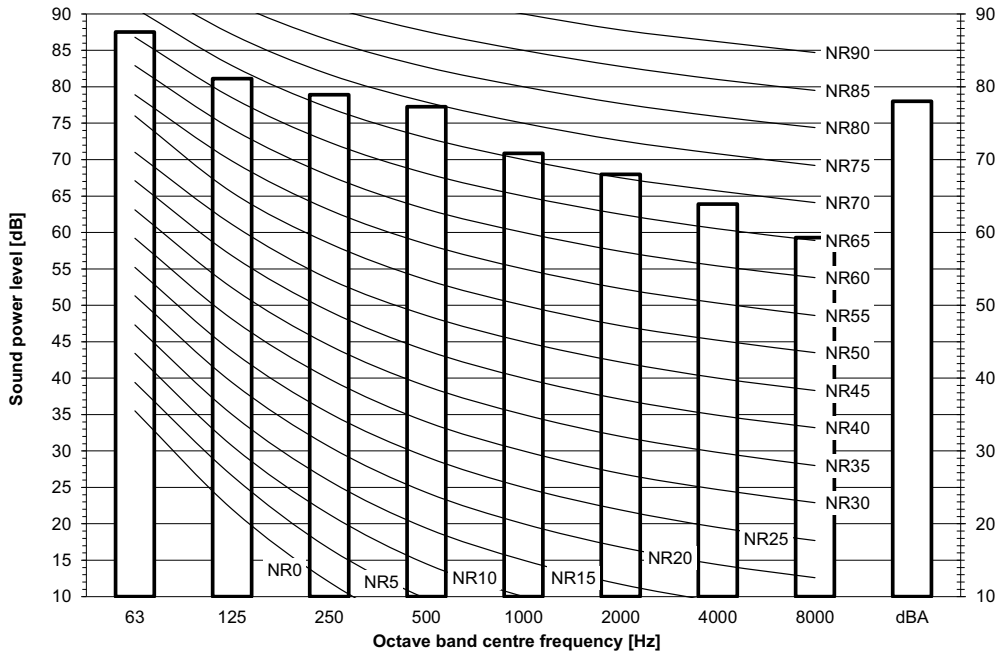

Notes
 dBA = A-weighted sound power level (A scale according to IEC).
 Reference acoustic intensity 0dB = 10E-6μW/m²
 Measured according to ISO 3744

3D119528

REYQ10U
RXYQQ10U
RXYQ10U
RYYQ10U
RYMQ10U

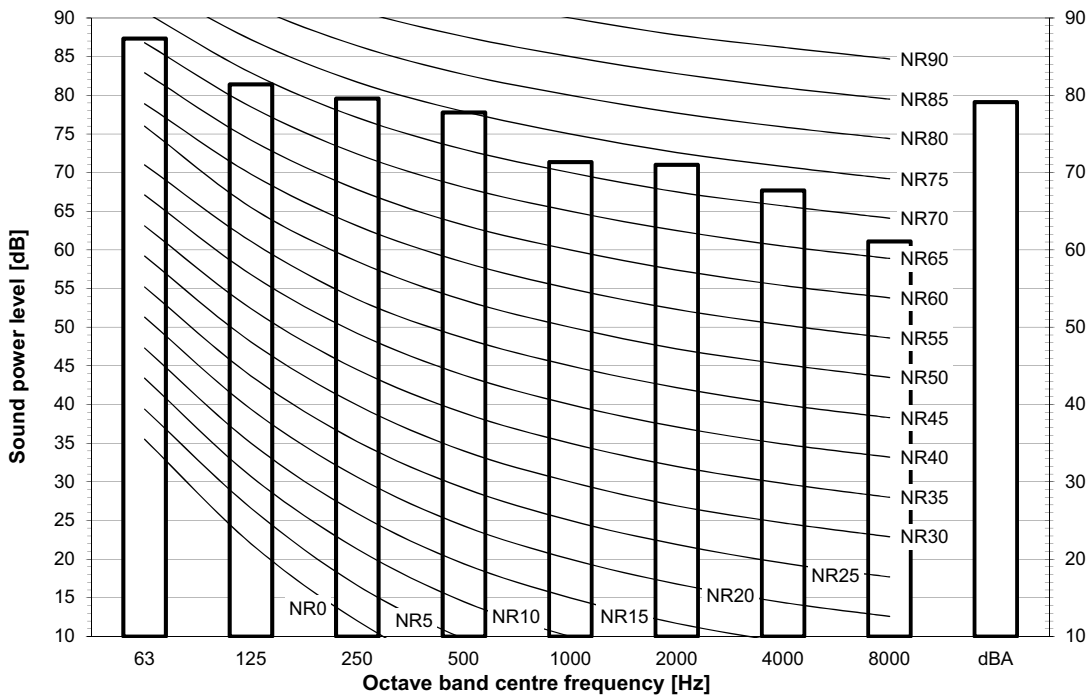

Notes
 dBA = A-weighted sound power level (A scale according to IEC).
 Reference acoustic intensity 0dB = 10E-6μW/m²
 Measured according to ISO 3744

3D119529

11 Sound data

11 - 1 Sound Power Spectrum

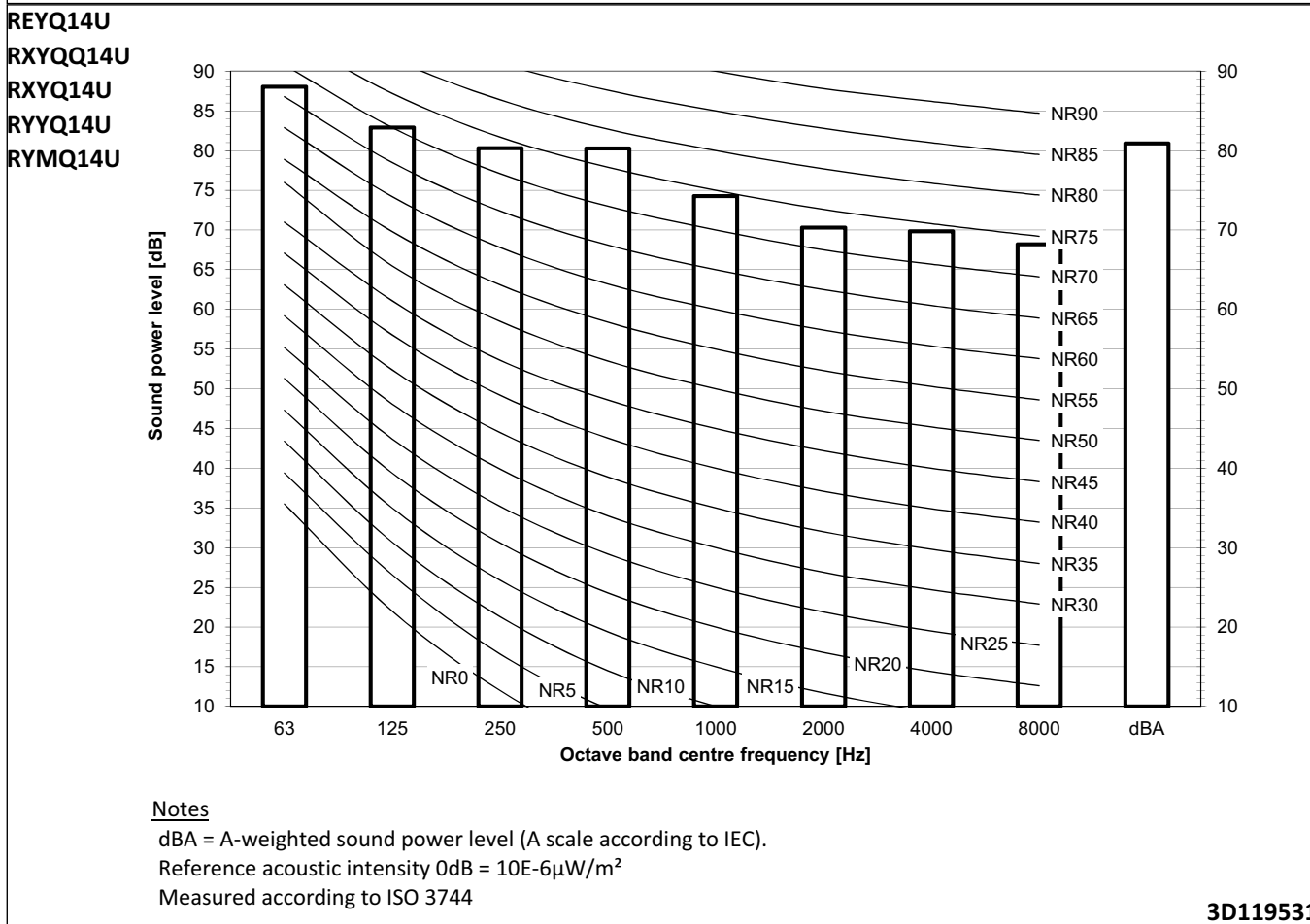
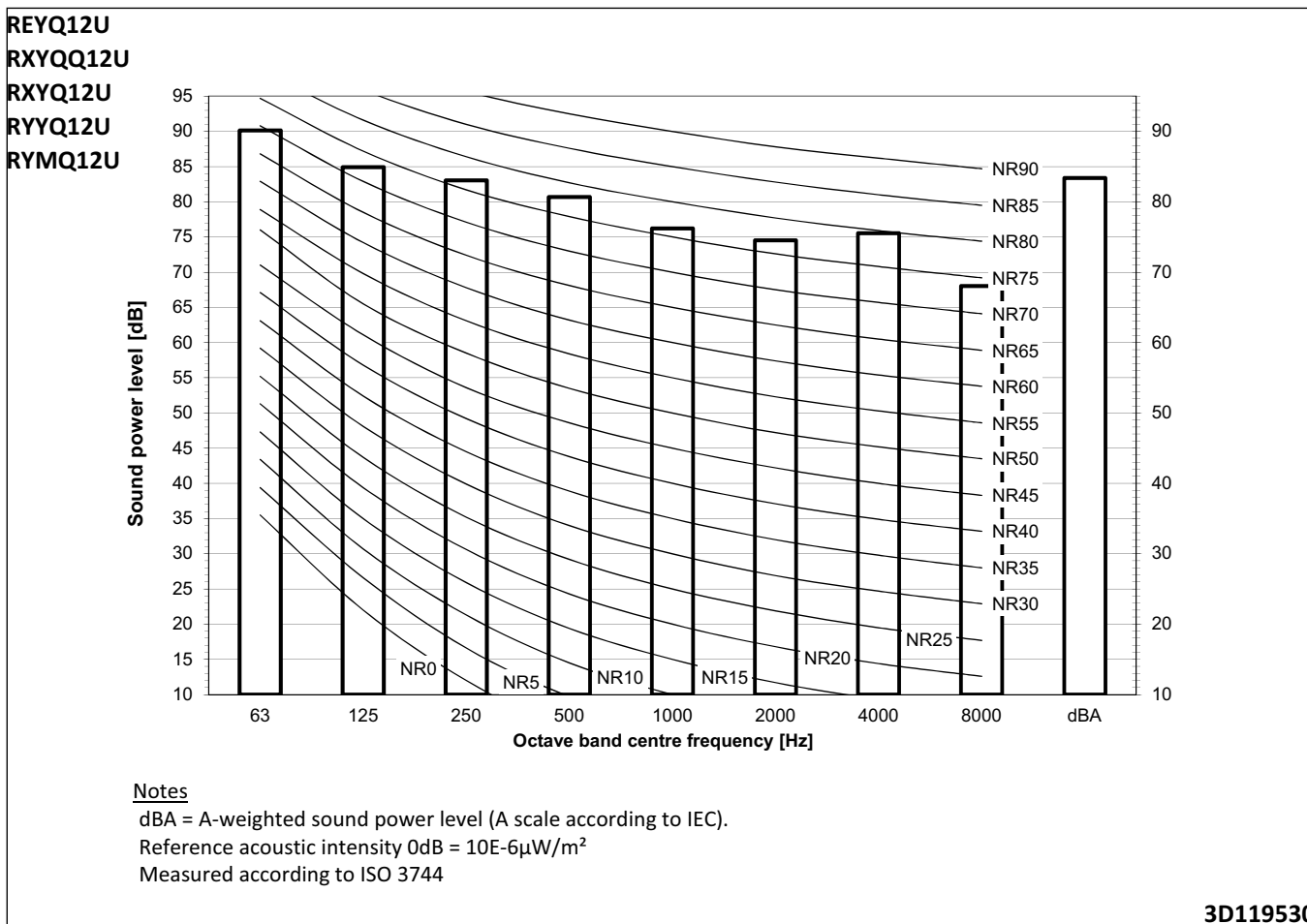

11 Sound data

11 - 1 Sound Power Spectrum

11

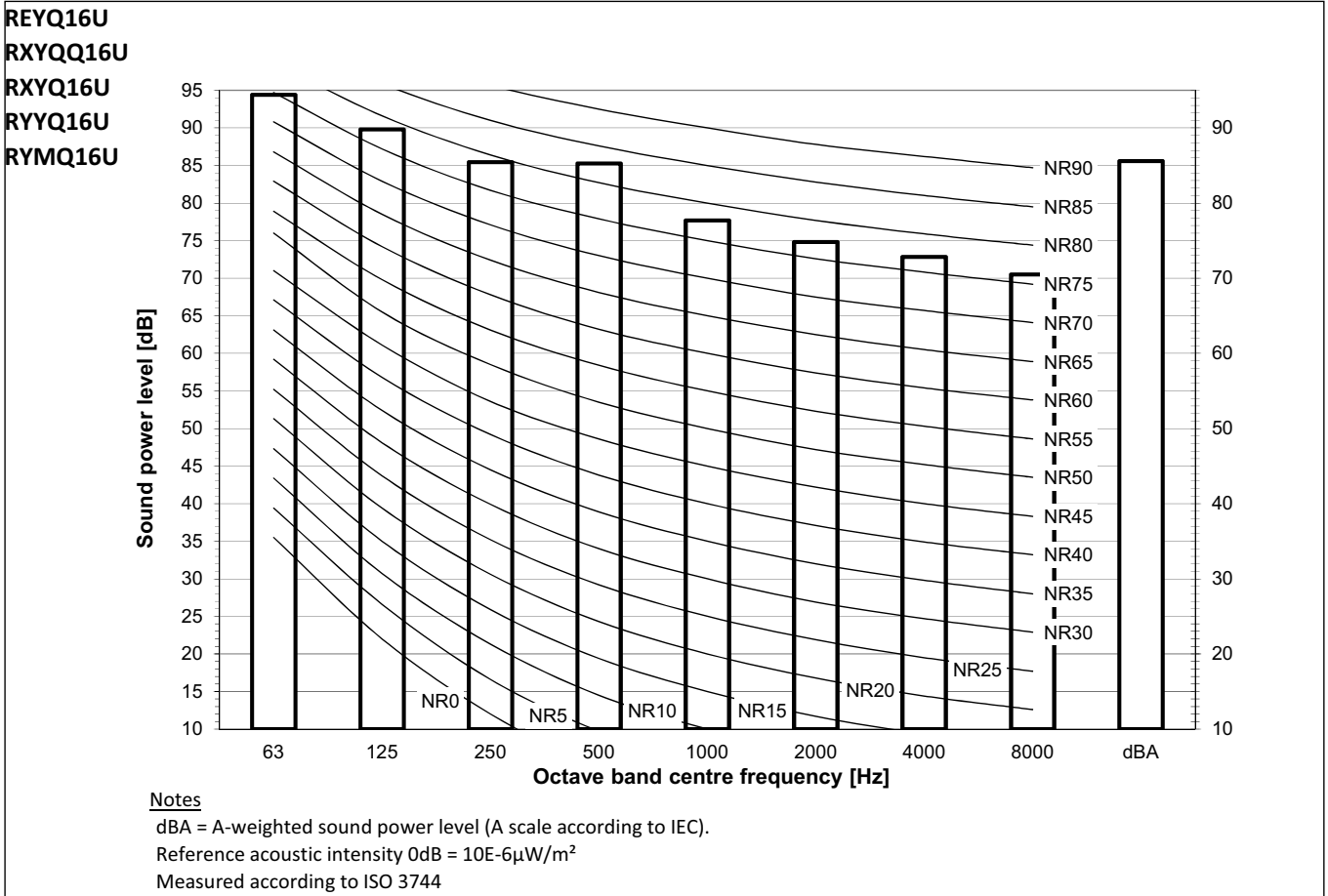

3D119532

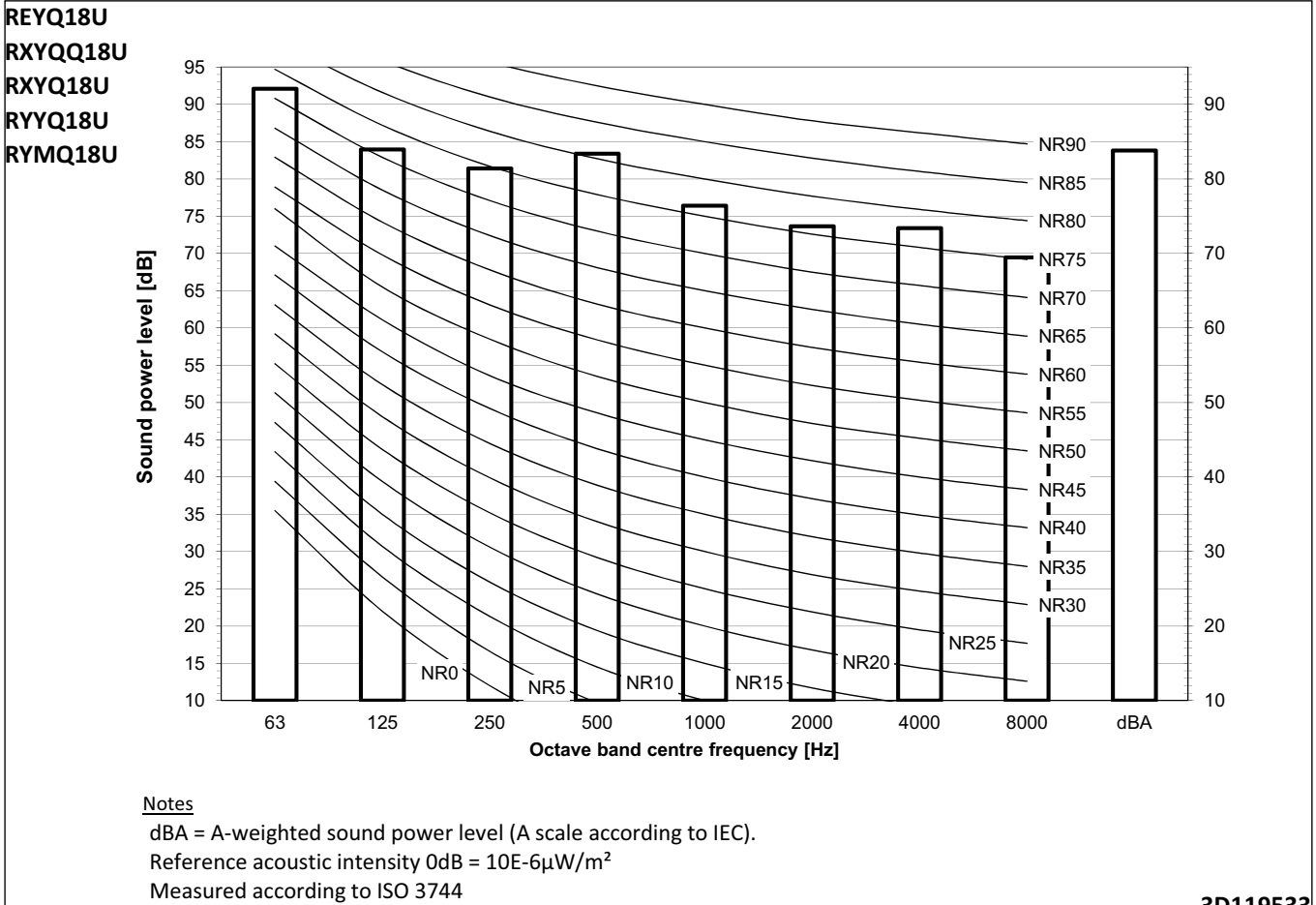

3D119533

11 Sound data

11 - 1 Sound Power Spectrum

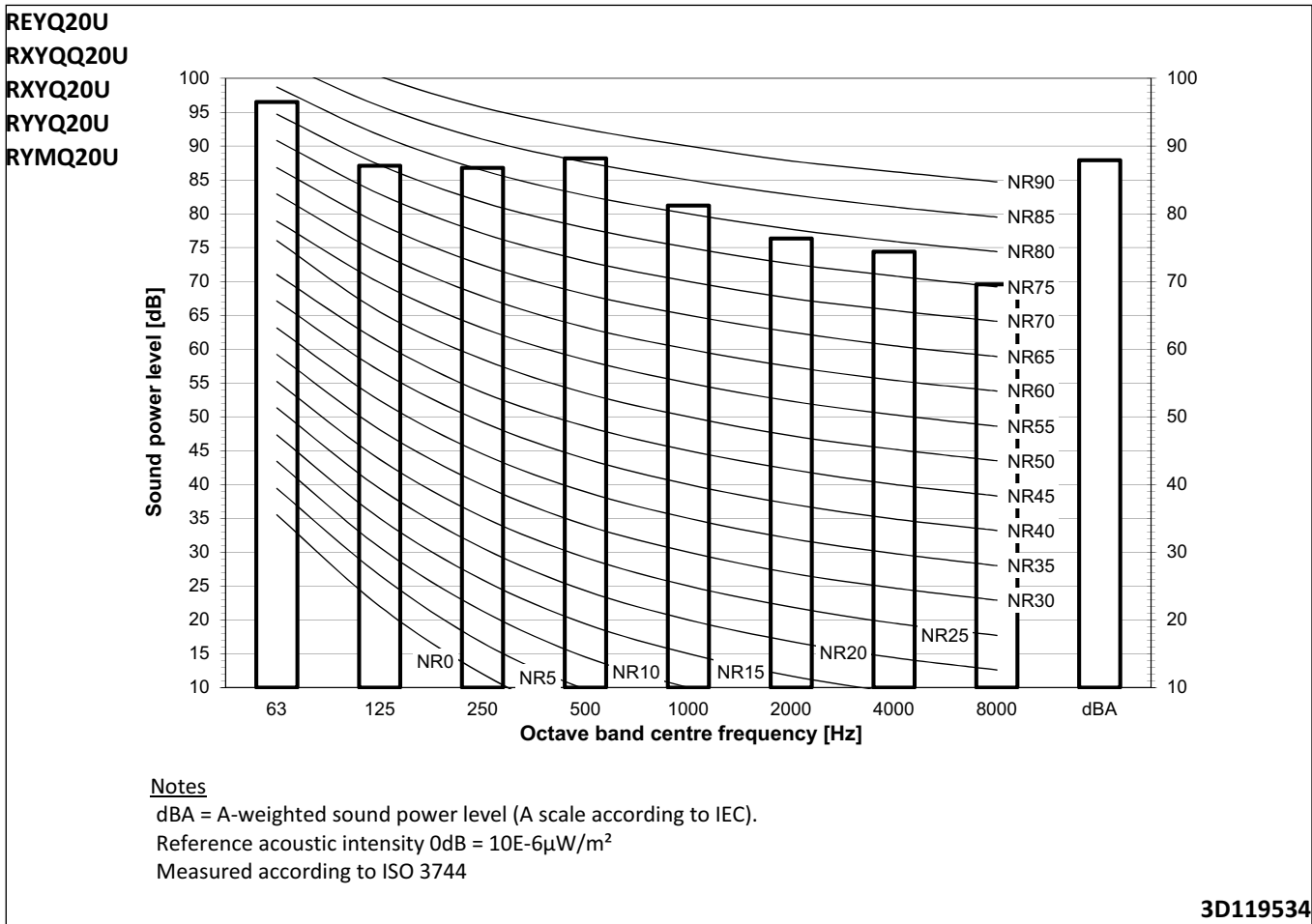

11 Sound data

11 - 2 Sound Pressure Spectrum

11

REMQ5U
REYQ8U
RXYQQ8U
RXYQ8U
RXYTQ8UYF
RYYQ8U
RYMQ8U

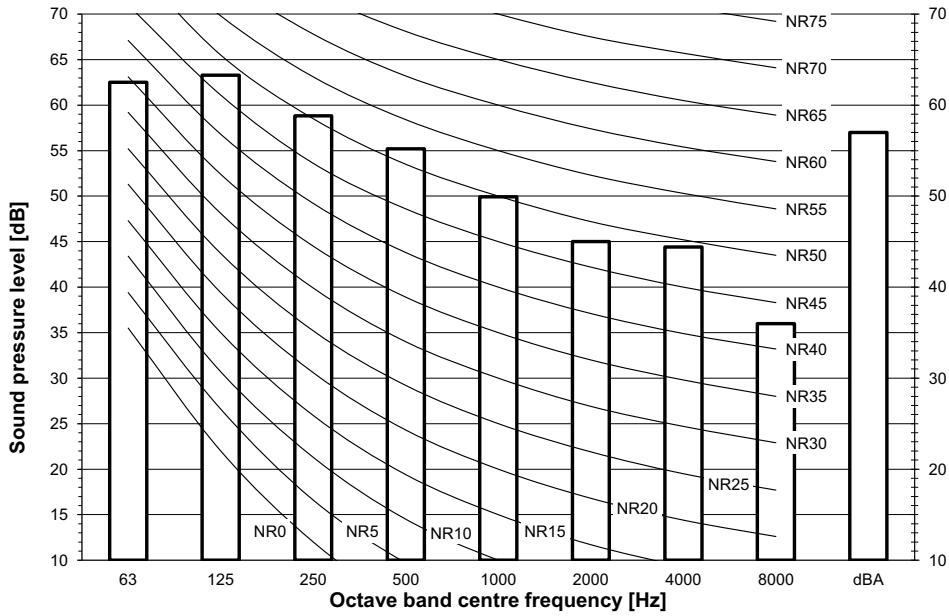

Notes

Data is valid at free field condition.
Data is valid at nominal operation condition.
dBA = A-weighted sound pressure level (A scale according to IEC).
Reference acoustic pressure 0 dB = 20 µPa

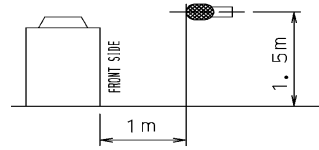

3D119521

REYQ10U
RXYQQ10U
RXYQ10U
RYYQ10U
RYMQ10U

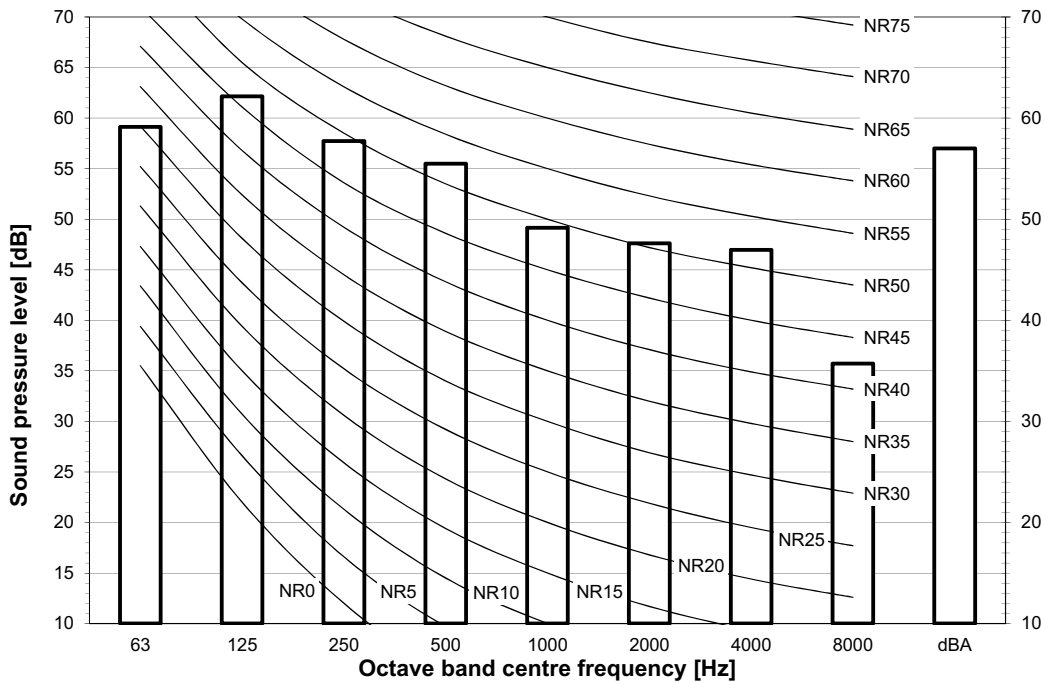

Notes

Data is valid at free field condition.
Data is valid at nominal operation condition.
dBA = A-weighted sound pressure level (A scale according to IEC).
Reference acoustic pressure 0 dB = 20 µPa

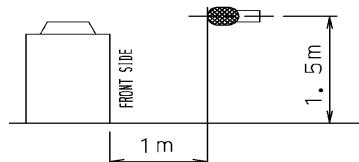

3D119522

11 Sound data

11 - 2 Sound Pressure Spectrum

REYQ12U
RXYQQ12U
RXYQ12U
RYYQ12U
RYMQ12U

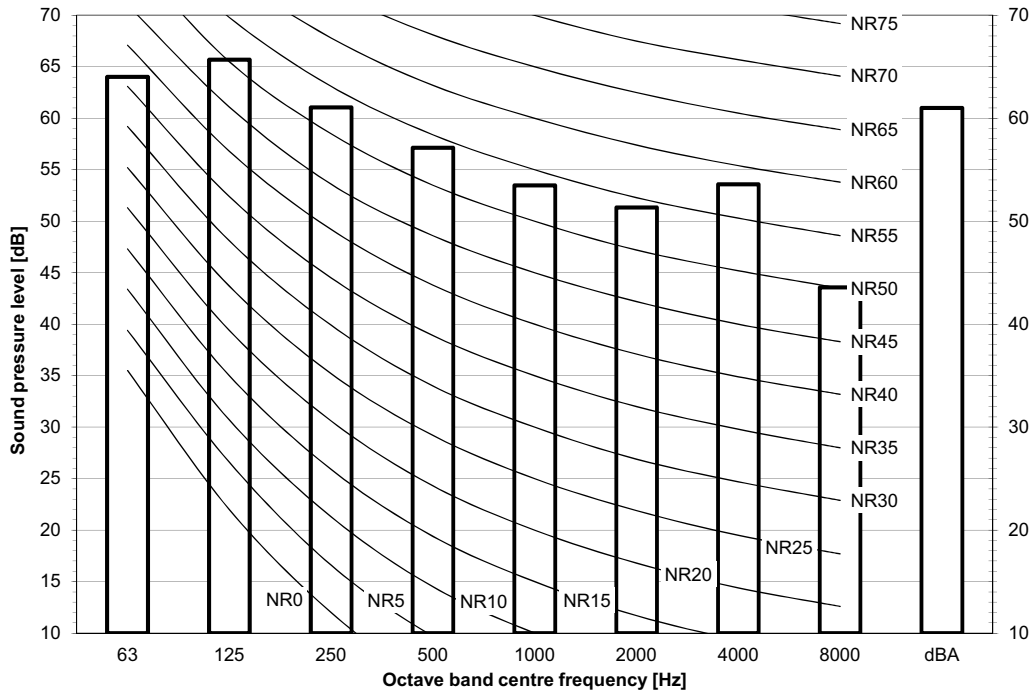

Notes

Data is valid at free field condition.
Data is valid at nominal operation condition.
dBA = A-weighted sound pressure level (A scale according to IEC).
Reference acoustic pressure 0 dB = 20 µPa

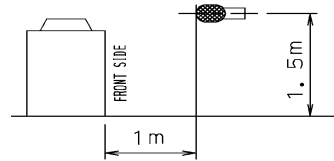

3D119523

REYQ14U
RXYQQ14U
RXYQ14U
RYYQ14U
RYMQ14U

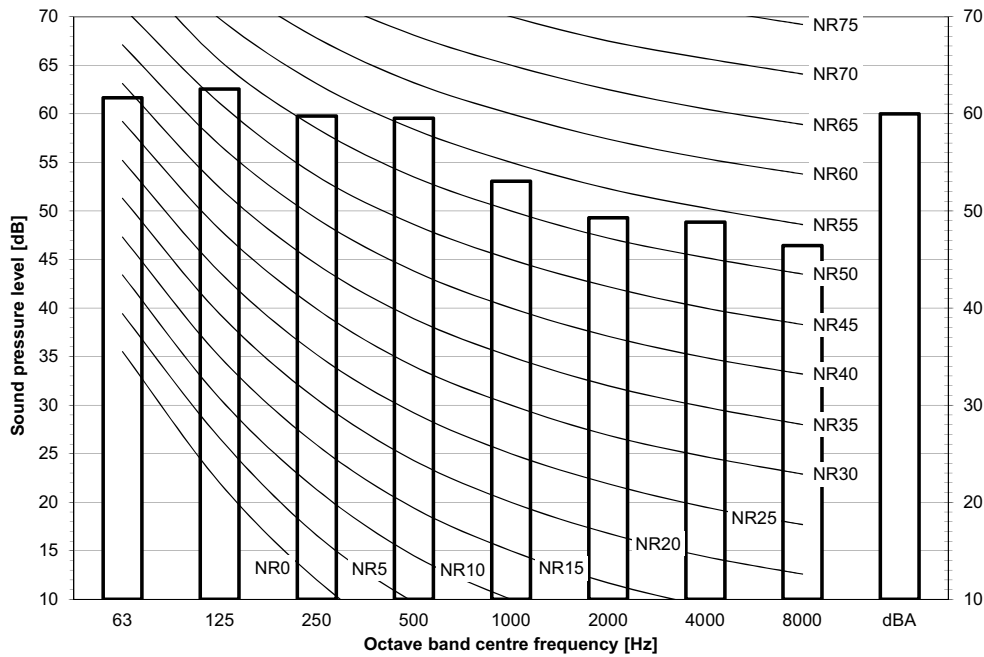

Notes

Data is valid at free field condition.
Data is valid at nominal operation condition.
dBA = A-weighted sound pressure level (A scale according to IEC).
Reference acoustic pressure 0 dB = 20 µPa

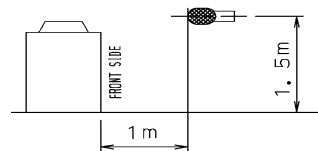

3D119524

11 Sound data

11 - 2 Sound Pressure Spectrum

11

REYQ16U
RXYQQ16U
RXYQ16U
RYYQ16U
RYMQ16U

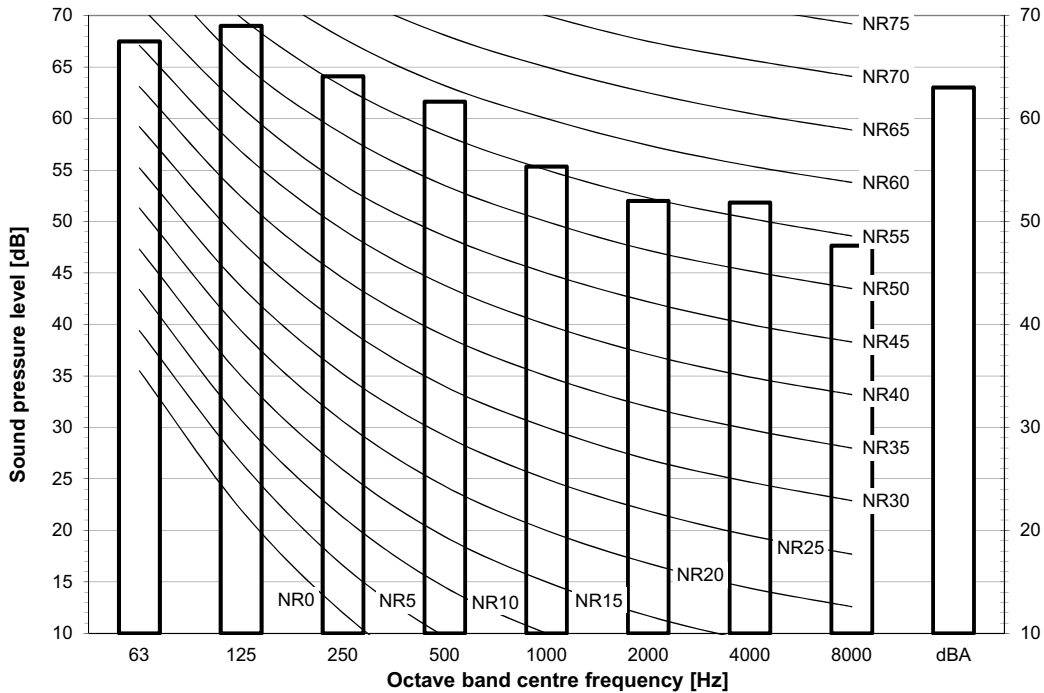

Notes

Data is valid at free field condition.
Data is valid at nominal operation condition.
dBA = A-weighted sound pressure level (A scale according to IEC).
Reference acoustic pressure 0 dB = 20 µPa

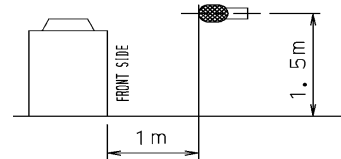

3D119525

REYQ18U
RXYQQ18U
RXYQ18U
RYYQ18U
RYMQ18U

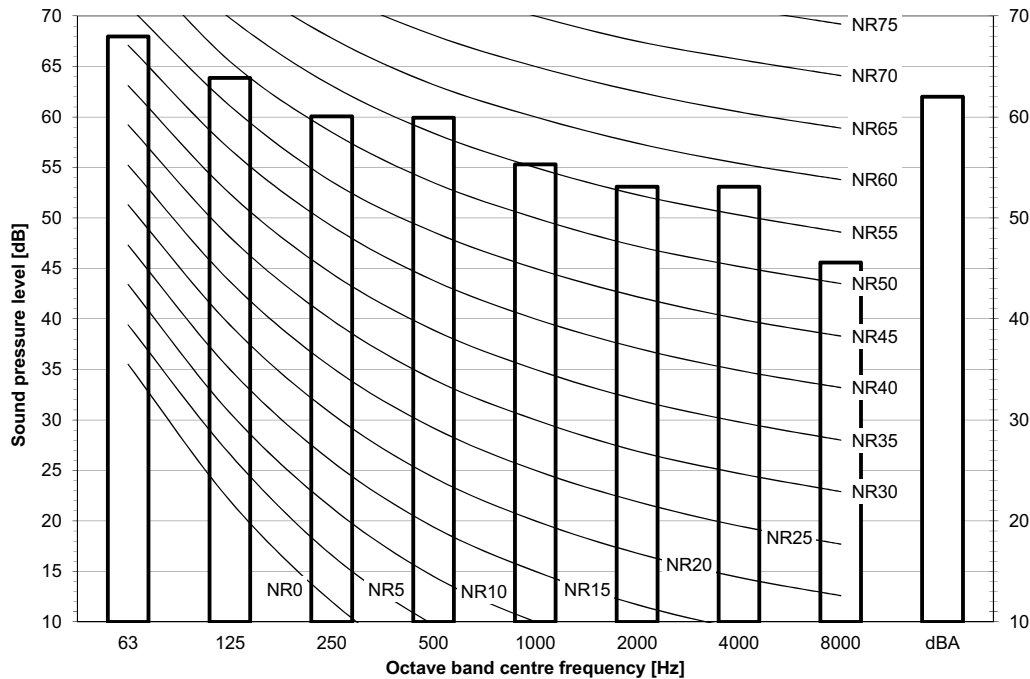

Notes

Data is valid at free field condition.
Data is valid at nominal operation condition.
dBA = A-weighted sound pressure level (A scale according to IEC).
Reference acoustic pressure 0 dB = 20 µPa

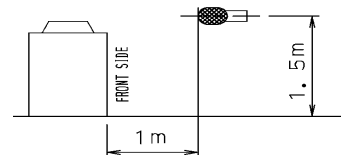

3D119526

11 Sound data

11 - 2 Sound Pressure Spectrum

REYQ20U
 RXYQQ20U
 RXYQ20U
 RYYQ20U
 RYMQ20U

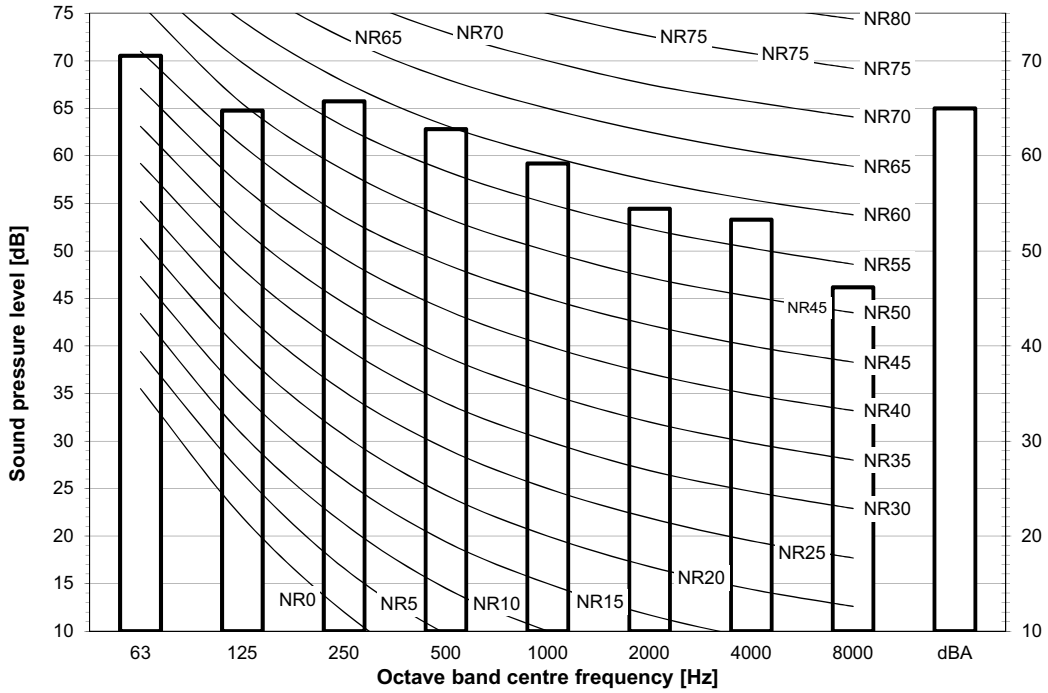

Notes

- Data is valid at free field condition.
- Data is valid at nominal operation condition.
- dBA = A-weighted sound pressure level (A scale according to IEC).
- Reference acoustic pressure 0 dB = 20 µPa

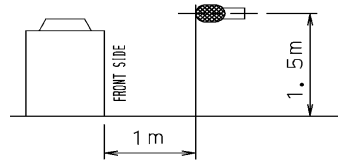

3D119527

11 Sound data

11 - 3 Sound Pressure Spectrum Quiet Mode

11

REMQ5U
REYQ8-12U
RXYQ8-12U
RXYQ8-12U
RXYTQ8UYF
RYY8-12U
RYMQ8-12U

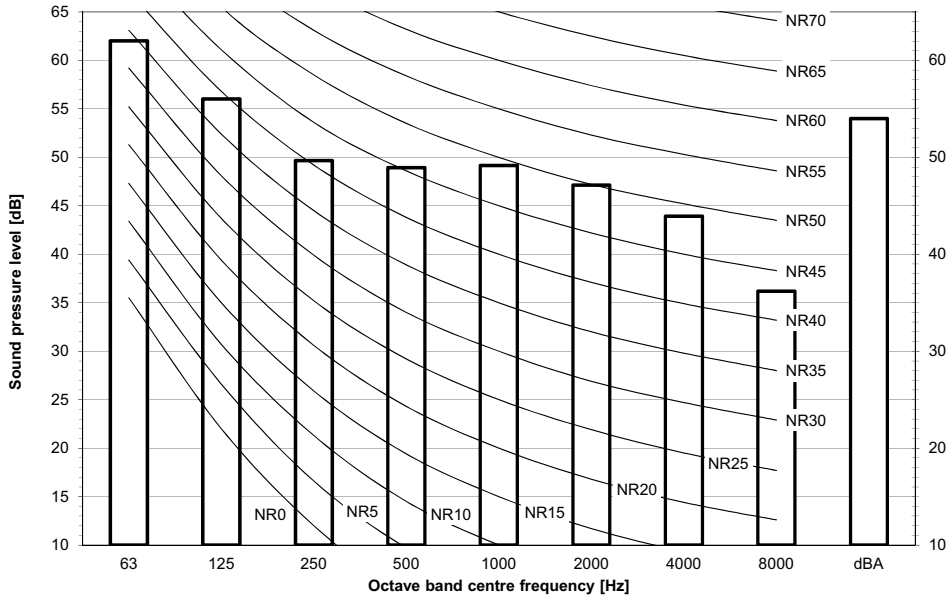

Notes
Data is valid at free field condition.
Data is valid at nominal operation condition.
dBA = A-weighted sound pressure level (A scale according to IEC).
Reference acoustic pressure 0 dB = 20 µPa
Data is valid under the following conditions
Cooling operation
Outdoor Ta: 35°C
Full load (maximum fan rps and maximum compressor rps for the dedicated low noise mode)

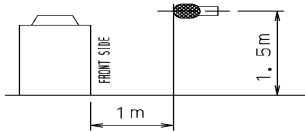

3D119535

REMQ5U
REYQ8-12U
RXYQ8-12U
RXYQ8-12U
RXYTQ8UYF
RYYQ8-12U
RYMQ8-12U

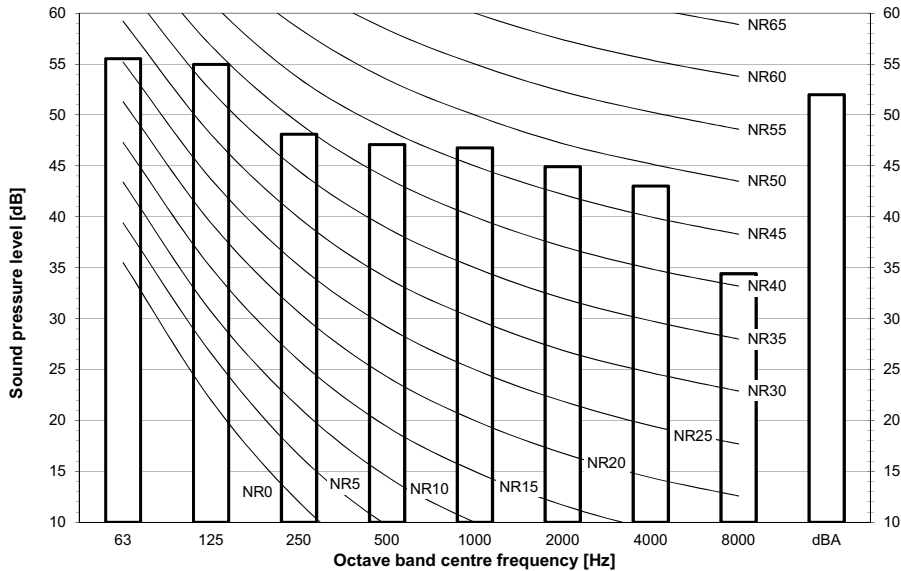

Notes
Data is valid at free field condition.
Data is valid at nominal operation condition.
dBA = A-weighted sound pressure level (A scale according to IEC).
Reference acoustic pressure 0 dB = 20 µPa
Data is valid under the following conditions
Cooling operation
Outdoor Ta: 35°C
Full load (maximum fan rps and maximum compressor rps for the dedicated low noise mode)

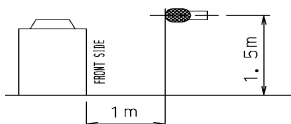

3D119536

11 Sound data

11 - 3 Sound Pressure Spectrum Quiet Mode

REMQ5U
 REYQ8-12U
 RXYQQ8-12U
 RXYQ8-12U
 RXYTQ8UYF
 RYYQ8-12U
 RYMQ8-12U

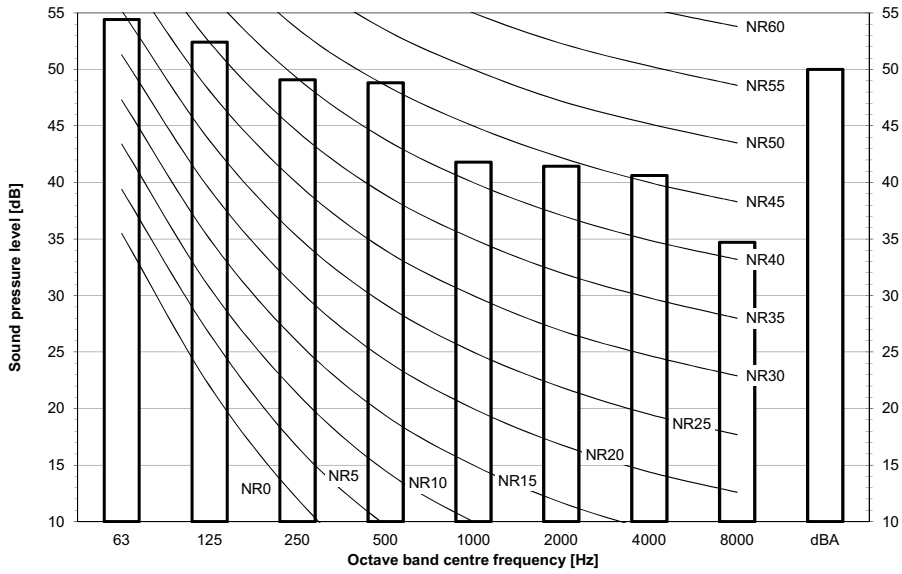

Notes
 Data is valid at free field condition.
 Data is valid at nominal operation condition.
 dBA = A-weighted sound pressure level (A scale according to IEC).
 Reference acoustic pressure 0 dB = 20 µPa
Data is valid under the following conditions
 Cooling operation
 Outdoor Ta: 35°C
 Full load (maximum fan rps and maximum compressor rps for the dedicated low noise mode)

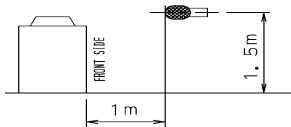

3D119537

REYQ14-16U
 RXYQQ14-16U
 RXYQ14-16U
 RXYTQ14-16UYF
 RYYQ14-16U
 RYMQ14-16U

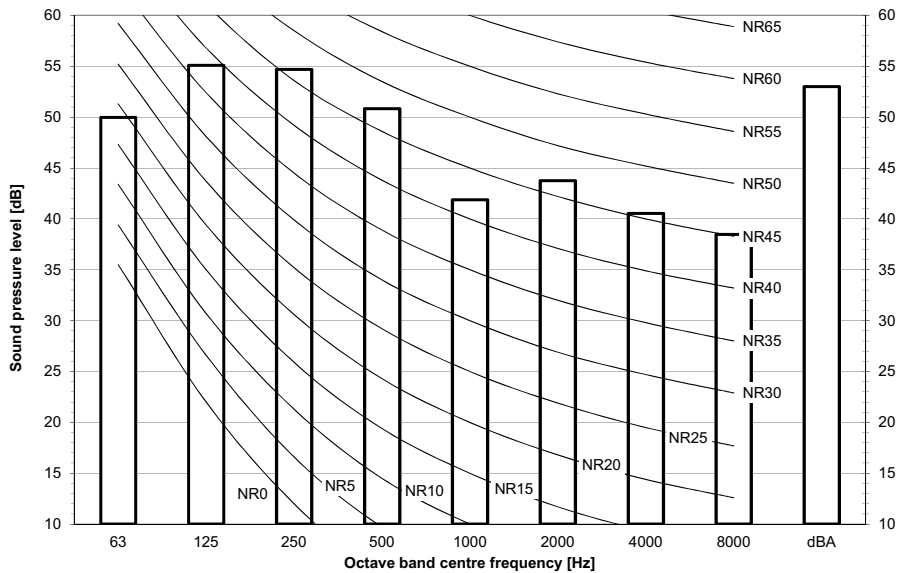

Notes
 Data is valid at free field condition.
 Data is valid at nominal operation condition.
 dBA = A-weighted sound pressure level (A scale according to IEC).
 Reference acoustic pressure 0 dB = 20 µPa
Data is valid under the following conditions
 Cooling operation
 Outdoor Ta: 35°C
 Full load (maximum fan rps and maximum compressor rps for the dedicated low noise mode)

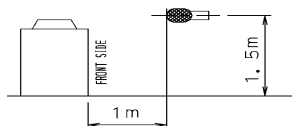

3D119538

11 Sound data

11 - 3 Sound Pressure Spectrum Quiet Mode

11

REYQ14-16U
 RXYQQ14-16U
 RXYQ14-16U
 RXYTQ14-16UYF
 RYYQ14-16U
 RYMQ14-16U

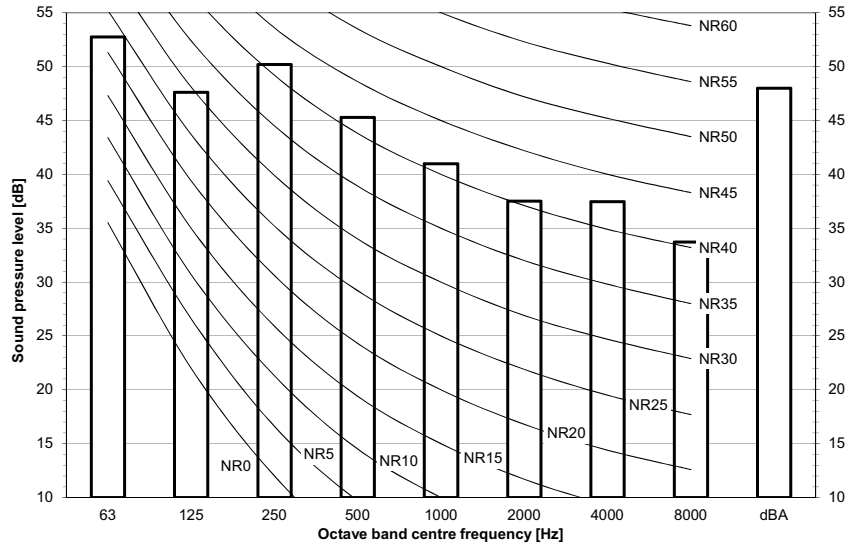

Notes
 Data is valid at free field condition.
 Data is valid at nominal operation condition.
 dBA = A-weighted sound pressure level (A scale according to IEC).
 Reference acoustic pressure 0 dB = 20 µPa

Data is valid under the following conditions

Cooling operation
 Outdoor Ta: 35°C
 Full load (maximum fan rps and maximum compressor rps for the dedicated low noise mode)

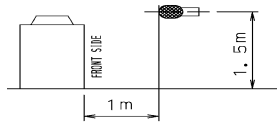

3D119539

REYQ14-16U
 RXYQQ14-16U
 RXYQ14U-16U
 RXYTQ14-16UYF
 RYYQ14-16U
 RYMQ14-16U

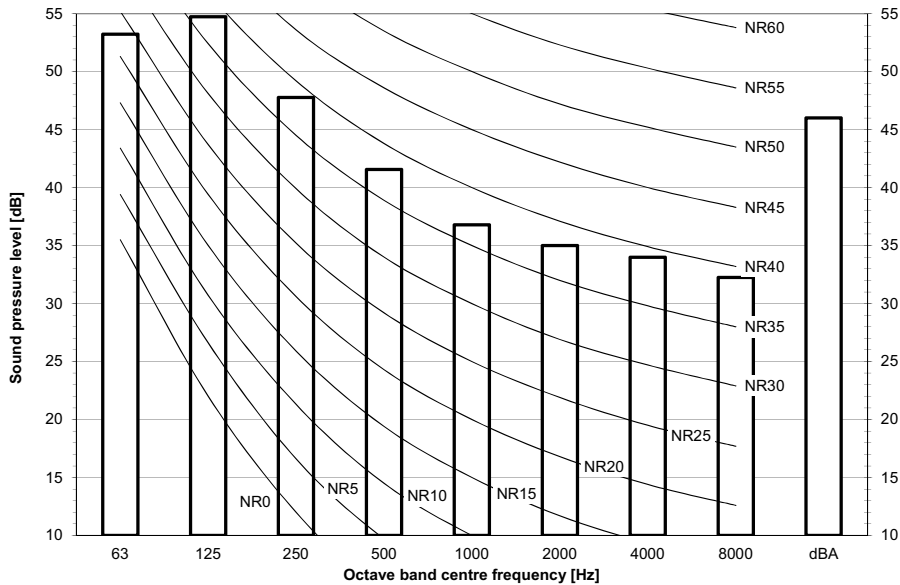

Notes
 Data is valid at free field condition.
 Data is valid at nominal operation condition.
 dBA = A-weighted sound pressure level (A scale according to IEC).
 Reference acoustic pressure 0 dB = 20 µPa

Data is valid under the following conditions

Cooling operation
 Outdoor Ta: 35°C
 Full load (maximum fan rps and maximum compressor rps for the dedicated low noise mode)

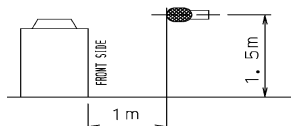

3D119540

11 Sound data

11 - 3 Sound Pressure Spectrum Quiet Mode

REYQ18-20U
 RXYQQ18-20U
 RXYQ18-20U
 RYYQ18-20U
 RYMQ18-20U

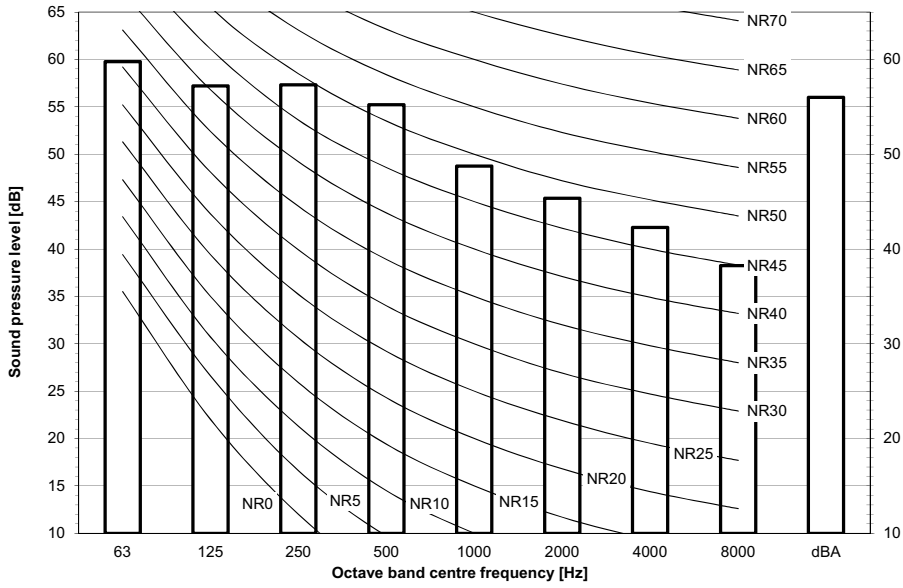

Notes
 Data is valid at free field condition.
 Data is valid at nominal operation condition.
 dBA = A-weighted sound pressure level (A scale according to IEC).
 Reference acoustic pressure 0 dB = 20 µPa
Data is valid under the following conditions
 Cooling operation
 Outdoor Ta: 35°C
 Full load (maximum fan rps and maximum compressor rps for the dedicated low noise mode)

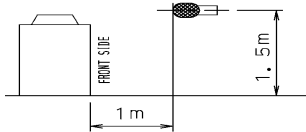

REYQ18-20U
 RXYQQ18-20U
 RXYQ18-20U
 RYYQ18-20U
 RYMQ18-20U

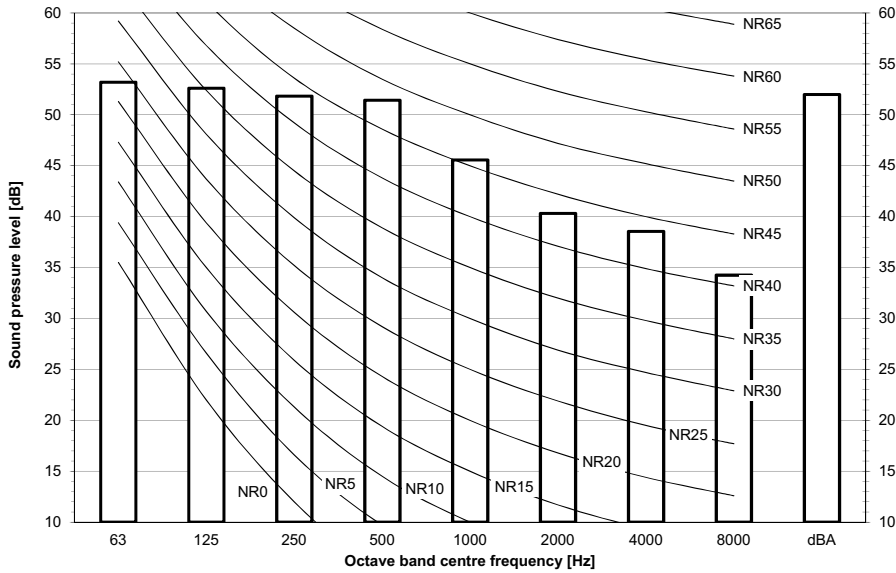

Notes
 Data is valid at free field condition.
 Data is valid at nominal operation condition.
 dBA = A-weighted sound pressure level (A scale according to IEC).
 Reference acoustic pressure 0 dB = 20 µPa
Data is valid under the following conditions
 Cooling operation
 Outdoor Ta: 35°C
 Full load (maximum fan rps and maximum compressor rps for the dedicated low noise mode)

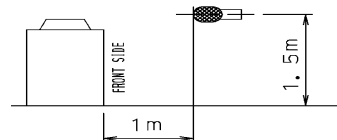

3D119542

11 Sound data

11 - 3 Sound Pressure Spectrum Quiet Mode

11

REYQ18-20U
 RXYQQ18-20U
 RXYQ18-20U
 RYYQ18-20U
 RYMQ18-20U

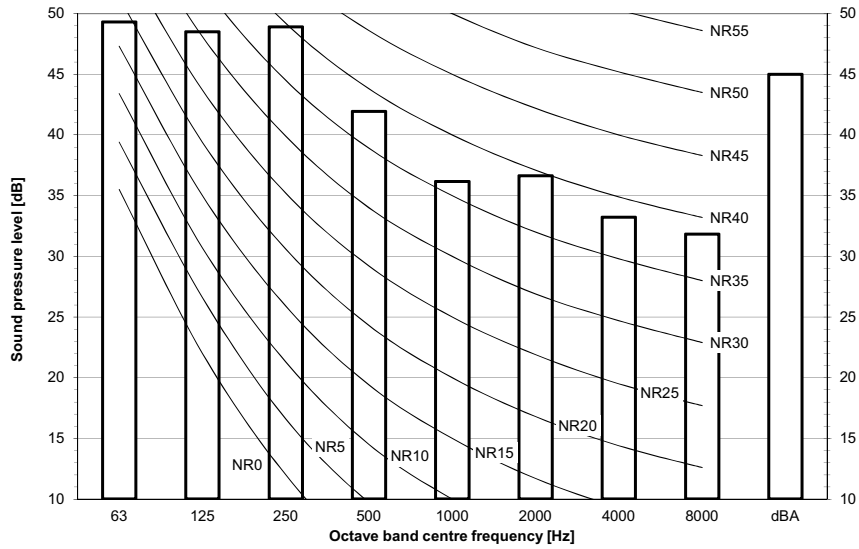

Notes

Data is valid at free field condition.
 Data is valid at nominal operation condition.
 dBA = A-weighted sound pressure level (A scale according to IEC).
 Reference acoustic pressure 0 dB = 20 μPa

Data is valid under the following conditions

Cooling operation
 Outdoor Ta: 35°C
 Full load (maximum fan rps and maximum compressor rps for the dedicated low noise mode)

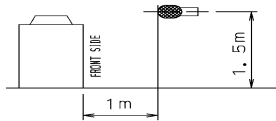

3D119543

12 Installation

12 - 1 Installation Method

REMQ5U
REYQ8-20U
RXYQ8-20U
RYYQ8-20U
RYYQ8-20U
RYMQ-20U

For single unit installation

For installation in rows

For centralised group layout

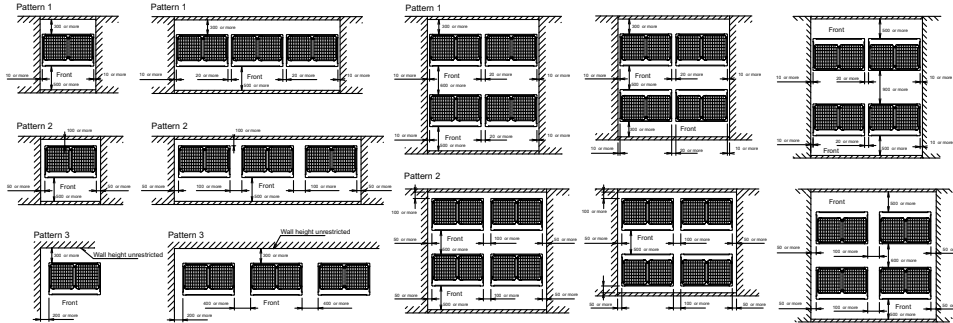

Notes

1. Height of the walls in case of patterns 1 and 2:

- Front: 1500mm
- Suction side: 500mm
- Side: height unrestricted

The installation space shown on this drawing is based on cooling operation at 35°C (outdoor temperature).

When the design outdoor ambient temperature exceeds 35°C or the load exceeds maximum ability of much generation load of heat in all outdoor unit, make sure the suction-side space is broader than the space shown on this drawing.

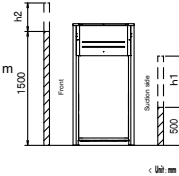

2. If the walls are higher than mentioned above, then additional service space is needed:

- suction side: service space + h1/2
- front side: service space + h2/2

3. When installing the units, select the pattern that best fits the available space.

Always keep in mind to leave sufficient space for a person to pass between unit and wall and for the air to circulate freely.

If more units are to be installed than are catered for in the above patterns, your layout should take into account of the possibility of short circuits.

4. Provide sufficient space at the front to connect refrigerant piping (comfortably).

3D118467

12 Installation

12 - 2 Fixation and Foundation of Units

12

REMQ5U
REYQ8-20U
RXYQ8-20U
RXYQ8-20U
RXYTQ8-16UYF
RYYQ8-20U
RYMQ8-20U

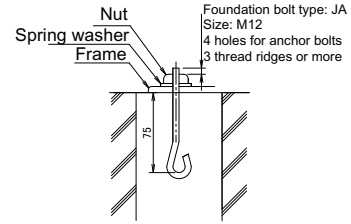
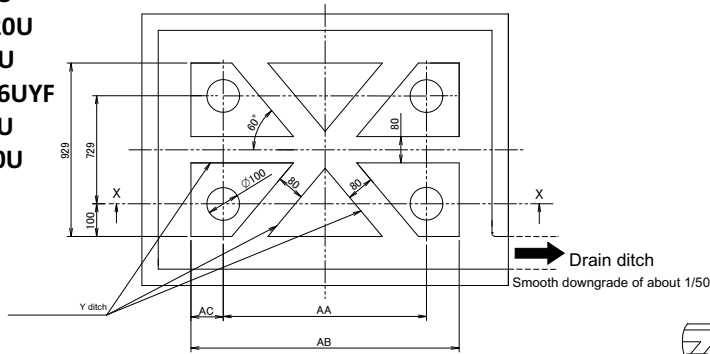

Foundation bolt fixing method

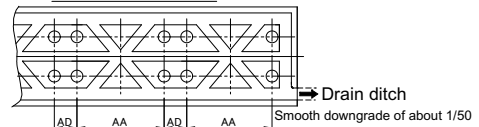

When building a foundation on the ground ↔ When building a foundation on a concrete floor

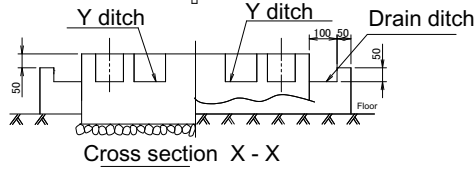

For multi-unit installation

Model	AA	AB	AC	AD
RYYQ8-12U	766	992	113	185
RYMQ8-12U				
RXYQ8-12U				
RXYQ8-12U				
REMQ5T/REYQ8-12U				
RXYTQ8U				
RYYQ14-20U	1076	1076	113	185
RYMQ14-20U				
RXYQ14-20U				
RXYQ14-20U				
RXYTQ10-16U				

Notes

1. Provide a drain ditch around the foundation to drain water from the installation area.
2. The surface has to be finished with mortar. The corner edges have to be chamfered.
3. Build the foundation on a concrete floor or, if not possible, make sure the foundation surface has a rough finish.
4. Use a cement/sand/gravel ratio of 1/2/4 for the concrete, and a diameter of 10 mm for the reinforcement bars (approximately, 300mm intervals).
5. When installing the equipment on a roof, make sure to check the strength of the floor and take adequate water proofing measures. **3D118459**

12 Installation

12 - 3 Refrigerant Pipe Selection

RXYQ-U
RYYQ-Y
RYMQ-U

VRV4
Heat pump
Piping restrictions 1/3

For the reference drawing, see page 2/3.

	Maximum piping length			Maximum height difference			Total piping length	
	Longest pipe (A+[B,G,E,J]) Actual / (Equivalent)	After first branch (B,G,E,J) Actual	After first branch (for multi-outdoor) (D) Actual / (Equivalent)	Indoor-to-outdoor ⁽³⁾ (H1) Outdoor above indoor / (indoor above outdoor)	Indoor-to-indoor (H2)	Outdoor-to-outdoor (H3)		
Standard								
<i>VRV DX indoor units only</i>	165/(190)m	40m ⁽¹⁾	10/(13)m	50/(40)m ⁽³⁾	30m	5m	1000m	
<i>Standard multi-combination</i>								
<i>All multi-outdoor-unit combinations except standard multi-outdoor-unit combinations</i>	135/(160)m	40m ⁽¹⁾	10/(13)m	50/(40)m ⁽³⁾	30m	5m	500m	
Hydrobox connection	135/(160)m	40m	10/(13)m	50/(40)m	15m	5m	300-500m ⁽⁵⁾	
RA connection	100/(120)m	50m ⁽²⁾	-	50/(40)m	15m	-	250m	
AHU connection	Pair	50/(55)m ⁽⁴⁾	-	40/(40)m	-	-	-	
	Multi ⁽⁶⁾	165/(190)m	40m	10/13m	40/(40)m	15m	5m	1000m
	Mix ⁽⁷⁾	165/(190)m	40m	10/13m	40/(40)m	15m	5m	1000m

Remark

For standard multi-outdoor-unit combinations, see 3D079534.

- (1) If all conditions below are met, the limitation can be extended up to 90 m
 - a. The piping length between all indoor units and the nearest branch kit is ≤ 40m.
 - b. It is necessary to increase the size of the gas and liquid piping if the pipe length between the first and the farthest indoor unit is >40m.
 - If the increased pipe size is larger than the pipe size of the main pipe, also increase the size of the main pipe.
 - c. When the piping size is increased, the piping length has to be counted as double.
 - The total piping length has to be within limitations.
 - d. The piping length difference between the nearest indoor unit from the first branch to the outdoor unit and the farthest indoor unit to the outdoor unit is ≤ 40m.
- (2) If the piping length between the first branch and the BP box or VRV indoor unit is more than 20m, increase the length of the gas and liquid piping between the first branch and the BP box or VRV indoor unit.
- (3) An extension to up to 90 m is possible without an additional option kit. Respect the following conditions:
 - > If the outdoor units are positioned higher than the indoor units:
 - a. Size up the liquid piping
 - b. A dedicated setting on the outdoor unit is required.
 - > If the outdoor units are positioned lower than the indoor units:
 - a. 40~60m Minimum connection ratio: 80%
 - 60~65m Minimum connection ratio: 90%
 - 65~80m Minimum connection ratio: 100%
 - 80~90m Minimum connection ratio: 110%
 - b. Size up the liquid piping
 - A dedicated setting on the outdoor unit is required.
- (4) The allowable minimum length is 5 m.
- (5) In case of multi-outdoor-unit combinations.
- (6) Multiple air handling units (AHU)(EKEXV + EKEQ kits).
- (7) Mix of AHU units and VRV DX indoor
- (8) If the equivalent piping length between is > 90m, size up the main liquid and gas piping.

12 Installation

12 - 3 Refrigerant Pipe Selection

12

RXYQ-U
RYYQ-U
RYMQ-U

VRV4
Heat pump
Piping restrictions 2/3

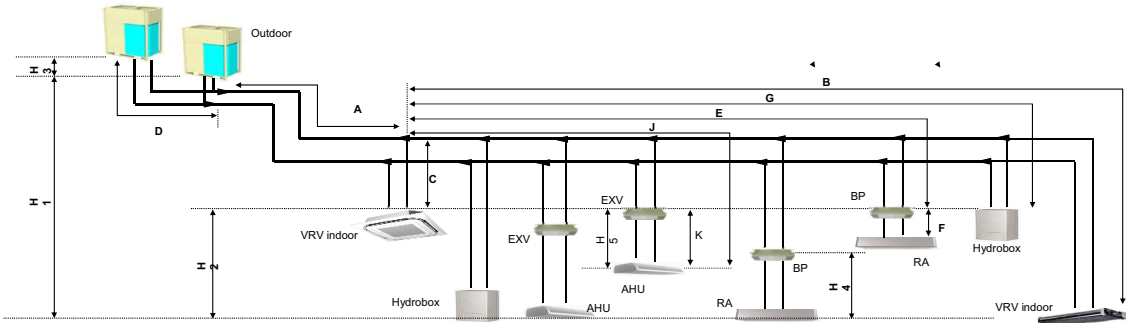

Remark

- (1) Schematic indication
Illustrations may differ from the actual appearance of the unit.
- (2) This is only to illustrate piping length limitations.
Combination of indoor unit types is not allowed.
Refer to combination table 3D079543 for details about the allowed combinations.

		Allowed piping length		Maximum height difference	
		BP to RA (F)	EXV to AHU (K)	BP to RA (H4)	EXV to AHU (H5)
		RA connection	2~15m	-	5m
AHU connection	Pair	-	≤5m	-	5m
	Multi ⁽¹⁾	-	≤5m	-	5m
	Mix ⁽²⁾	-	≤5m	-	5m

Remark

- (1) Multiple air handling units (AHU)(EKEVX + EKEQ kits).
- (2) Mix of AHU units and VRV DX indoor

3D079540E

12 Installation

12 - 3 Refrigerant Pipe Selection

RXYQ-U
RYYQ-U
RYMQ-U

VRV4
Heat pump
Piping restrictions 3/3

System pattern Allowed connection ratio (CR) Other combinations are not allowed.	Total		Allowed capacity			
	Capacity	Indoor unit quantity (VRV, RA, AHU, Hydrobox)	VRV DX indoor unit	RA DX indoor unit	Hydrobox unit	Air handling unit (AHU)
VRV DX indoor units only	50~130%	Max.64	50~130%	-	-	-
VRV DX indoor unit + RA DX	80~130%	Max.32 ⁽¹⁾	0~130%	0~130%	-	-
RA DX indoor unit	80~130%	Max.32 ⁽¹⁾	-	80~130%	-	-
VRV DX indoor unit + LT hydrobox	50~130%	Max.32	50~130%	-	0~80%	-
VRV DX indoor unit + AHU	50~110% ⁽³⁾	Max.64 ⁽²⁾	50~110%	-	-	0~110%
AHU only Pair + multi (4)	90~110% ⁽³⁾	Max.64 ⁽²⁾	-	-	-	90~110%

Remark

- (1) There is no restriction on the number of connectable BP boxes.
- (2) For connection with AHU
EKEXV kits are also considered indoor units.
- (3) Restrictions regarding the air handling unit capacity
- (4) Pair AHU = system with 1 air handling unit connected to one outdoor unit
Multi AHU = system with multiple air handling units connected to one outdoor unit

About ventilation applications

- I. FXMQ_MF units are considered air handling units, following air handling unit limitations.
Maximum connection ratio when combined with VRV DX indoor units: <30%.
Maximum connection ratio when only air handling units are connected: <100%.
For information on the operation range, refer to the documentation of the FXMQ_MF unit.
- II. Biddle air curtains are considered air handling units, following air handling unit limitations:
For information on the operation range, refer to the documentation of the Biddle unit.
- III. [EKEXV + EKEQ] units combined with an air handling unit are considered air handling units, following air handling unit limitations.
For information on the operation range, refer to the documentation of the EKEXV-EKEQ unit.
- IV. VKM units are considered to be regular VRV DX indoor units.
For information on the operation range, refer to the documentation of the VKM unit.
- V. Because there is no refrigerant connection with the outdoor unit (only communication F1/F2), VAM units do not have connection limitations.
However, since there is communication via F1/F2, count them as regular indoor unit when calculating the maximum allowed number of connectable indoor units.

13 Operation range

13 - 1 Operation Range

13

RXYQQ-U
RXYQ-U
RYYQ-U
RYMQ-U

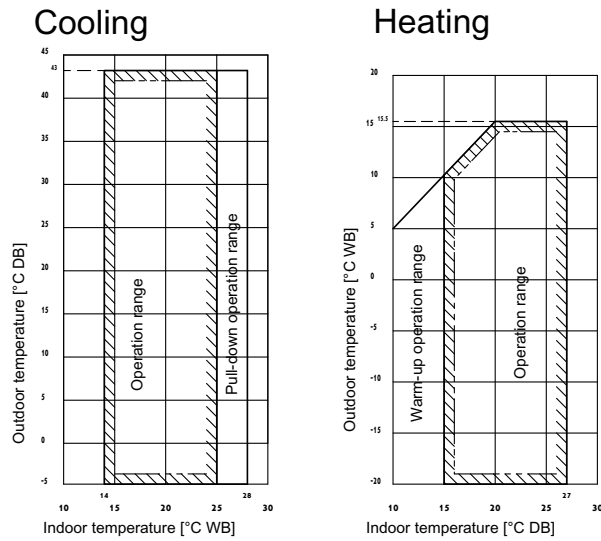

Notes

1. These figures assume the following operation conditions

Indoor and outdoor units
Equivalent piping length: 5m
Level difference: 0m

- 2. Depending on operation and installation conditions, the indoor unit can change over to freeze-up operation (indoor de-icing).
- 3. To reduce the freeze-up operation (indoor de-icing) frequency, it is recommended to install the outdoor unit in a location not exposed to wind.
- 4. Operation range is valid in case direct expansion indoor units are used.

3D118465

14 Appropriate Indoors

14 - 1 Appropriate Indoors

RYYQ-U
RYMQ-U
RXYQ-U

Recommended indoor units for ·RXYQ*U* / RYYQ*U* / RYMQ*U*· outdoor units

HP	8	10	12	14	16	18	20
	4xFXMQ50	4xFXMQ63	6xFXMQ50	1xFXMQ50 5xFXMQ63	4xFXMQ63 2xFXMQ80	3xFXMQ50 5xFXMQ63	2xFXMQ50 6xFXMQ63

For multi outdoor units >16HP, the recommended amount of indoor units is the sum of the indoor units defined for a single outdoor unit.
For details about the allowed combinations, see the engineering databook.

Appropriate indoor units for ·RXYQ*U* / RYYQ*U* / RYMQ*U*· outdoor units

Covered by ·ENER LOT21·

- FXFQ20-25-32-40-50-63-80-100-125
- FXZQ15-20-25-32-40-50
- FXCQ20-25-32-40-50-63-80-125
- FXKQ25-32-40-63
- FXDQ15-20-25-32-40-50-63
- FXSQ15-20-25-32-40-50-63-80-100-125-140
- FXMQ50-63-80-100-125-200-250
- FXAQ15-20-25-32-40-50-63
- FXHQ32-63-100
- FXUQ71-100
- FXNQ20-25-32-40-50-63
- FXLQ20-25-32-40-50-63

Covered by ·ENER LOT10·

- FTXJ25-35-50
- FTXM20-25-35-42-50-60-71
- CTXM15
- FLXS25-35-50-60
- FVXM25-35-50
- FVXG25-35-50

Outside the scope of ·ENER LOT21·

- EKEXV50-63-80-100-125-140-200-250-400-500 + EKEQM / EKEQF
- HXY080-125
- VKM50-80-100
- CYVS100-150-200-250
- CYVM100-150-200-250
- CYVL100-150-200-250

3D118461



Daikin Europe N.V. Naamloze Vennootschap - Zandvoordestraat 300, B-8400 Oostende - Belgium - www.daikin.eu - BE 0412 120 336 - RPR Oostende

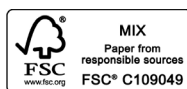
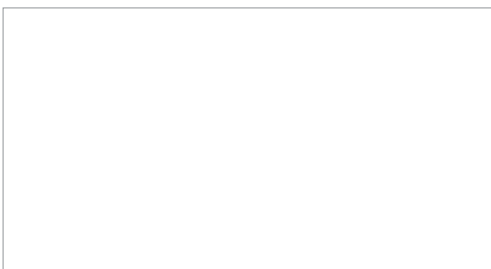

EEDEN19 02/19



The present leaflet is drawn up by way of information only and does not constitute an offer binding upon Daikin Europe N.V.. Daikin Europe N.V. has compiled the content of this leaflet to the best of its knowledge. No express or implied warranty is given for the completeness, accuracy, reliability or fitness for particular purpose of its content and the products and services presented therein. Specifications are subject to change without prior notice. Daikin Europe N.V. explicitly rejects any liability for any direct or indirect damage, in the broadest sense, arising from or related to the use and/or interpretation of this leaflet. All content is copyrighted by Daikin Europe N.V.