

# HITACHI

## SERVICE MANUAL TECHNICAL INFORMATION

FOR SERVICE PERSONNEL ONLY

INDOOR UNIT



RAK-18QXD  
RAK-25RXD  
RAK-35RXD  
RAK-50RXD

This manual describes only points that differ from

RAM-33NP2B (PM NO.0581E)  
RAM-40NP2B (PM NO.0582E)  
RAM-53NP2B, RAM-53NP3B (PM NO.0583E)  
RAM-68NP3B (PM NO.0584E)  
RAM-70NP4B (PM NO.0585E)  
RAM-90NP5B (PM NO.0586E)  
RAM-110NP6B (PM NO.0587E)  
RAC-25WXD, RAC-35WXD, RAC-50WXD (JCH-WH NO.0112E)  
for items not described in this manual.

JCH-WH

NO.0111E

RAK-18QXD

RAK-35RXD

RAK-25RXD

RAK-50RXD

REFER TO THE FOUNDATION MANUAL  
CONTENTS

SPECIFICATIONS .....	6
HOW TO USE .....	9
CONSTRUCTION AND DIMENSIONAL DIAGRAM .....	29
MAIN PARTS COMPONENT .....	30
WIRING DIAGRAM .....	31
CIRCUIT DIAGRAM .....	33
BLOCK DIAGRAM .....	35
BASIC MODE .....	36
REFRIGERATING CYCLE DIAGRAM .....	47
PROCEDURE FOR DISASSEMBLY AND REASSEMBLY.....	49
DESCRIPTION OF MAIN CIRCUIT OPERATION .....	51
SERVICE CALL Q & A .....	61
VARIOUS SETTINGS .....	71
PARTS LIST AND DIAGRAM .....	90

Indoor unit		RAK-18QXD	RAK-25RXD	RAK-35RXD	RAK-50RXD
Single outdoor unit		-	RAC-25WXD	RAC-35WXD	RAC-50WXD
Multi outdoor unit	RAM-33NP2B	o	o	-	-
	RAM-40NP2B	o	o	o	-
	RAM-53NP2B	o	o	o	o
	RAM-53NP3B	o	o	o	o
	RAM-68NP3B	o	o	o	o
	RAM-70NP4B	o	o	o	o
	RAM-90NP5B	o	o	o	o
	RAM-110NP6B	o	o	o	o

### SPECIFICATIONS

TYPE	DC INVERTER					
	INDOOR UNIT		OUTDOOR UNIT		INDOOR UNIT	
MODEL	RAK-25RXD		RAC-25WXD		RAK-35RXD	
POWER SOURCE	1 PHASE, 50Hz, 220-230V		1 PHASE, 50Hz, 220-230V		1 PHASE, 50Hz, 220-230V	
COOLING	TOTAL INPUT (W)	481 (250~1,000)		814 (250~1,400)		1,397 (500~2,100)
	TOTAL AMPERES (A)	2.92-2.79		3.74-3.57		6.36-6.09
	CAPACITY (B.T.U./h)	2.50 (0.90~3.10)		3.50 (0.90~4.00)		5.00 (1.90~5.20)
HEATING	TOTAL INPUT (W)	593 (250~1,200)		800 (250~1,600)		1,415 (500~2,700)
	TOTAL AMPERES (A)	2.73-2.61		3.67-3.51		6.44-6.16
	CAPACITY (B.T.U./h)	3.20 (0.90~4.20)		4.00 (0.90~4.80)		5.80 (2.20~7.00)
DIMENSIONS (mm)	W	900	792(+65)*	900	792(+65)*	900
	H	295	600	295	600	295
	D	210	299(+27.5)*	210	299(+27.5)*	210
NET WEIGHT (Kg)	11		37.5		11	

\* After installation

SPECIFICATIONS AND PARTS ARE SUBJECT TO CHANGE FOR IMPROVEMENT

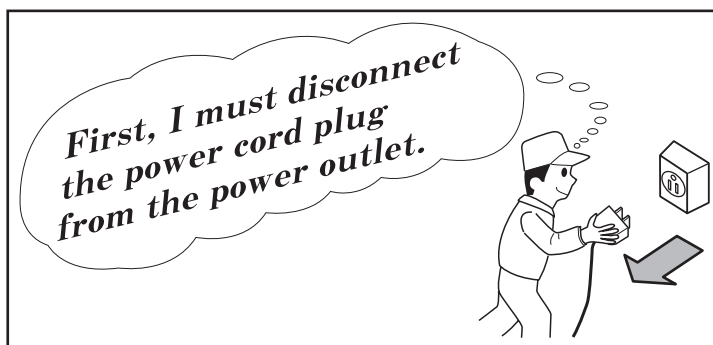
## ROOM AIR CONDITIONER

INDOOR UNIT

Johnson Controls-Hitachi Air Conditioning Wuhu Co., Ltd.

## SAFETY DURING REPAIR WORK

1. In order to disassemble and repair the unit in question, be sure to disconnect the power cord plug from the power outlet before starting the work.



2. If it is necessary to replace any parts, they should be replaced with respective genuine parts for the unit, and the replacement must be effected in correct manner according to the instructions in the Service Manual of the unit.

If the contacts of electrical parts are defective, replace the electrical parts without trying to repair them



3. After completion of repairs, the initial state should be restored.
4. Lead wires should be connected and laid as in the initial state.
5. Modification of the unit by the user himself should absolutely be prohibited.
6. Tools and measuring instruments for use in repairs or inspection should be accurately calibrated in advance.
7. In installing the unit having been repaired, be careful to prevent the occurrence of any accident such as electrical shock, leak of current, or bodily injury due to the drop of any part.
8. To check the insulation of the unit, measure the insulation resistance between the power cord plug and grounding terminal of the unit.  
The insulation resistance should be  $1M\Omega$  or more as measured by a 500V DC megger.
9. The initial location of installation such as window, floor or the other should be checked for being safe enough to support the repaired unit again.  
If it is found not so strong and safe, the unit should be installed at the initial location after reinforced or at a new location.
10. Any inflammable object must not be placed about the location of installation.
11. Check the grounding to see whether it is proper or not, and if it is found improper, connect the grounding terminal to the earth.



# WORKING STANDARDS FOR PREVENTING BREAKAGE OF SEMICONDUCTORS

## 1. Scope

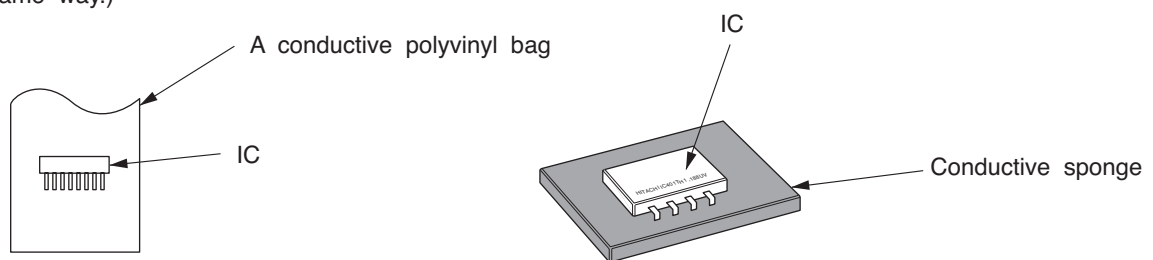
The standards provide for items to be generally observed in carrying and handling semiconductors in relative manufactures during maintenance and handling thereof. (They apply the same to handling of abnormal goods such as rejected goods being returned.)

## 2. Object parts

- (1) Microcomputer
- (2) Integrated circuits (I.C.)
- (3) Field effective transistor (F.E.T.)
- (4) P.C. boards or the like to which the parts mentioned in (1) and (2) of this paragraph are equipped.

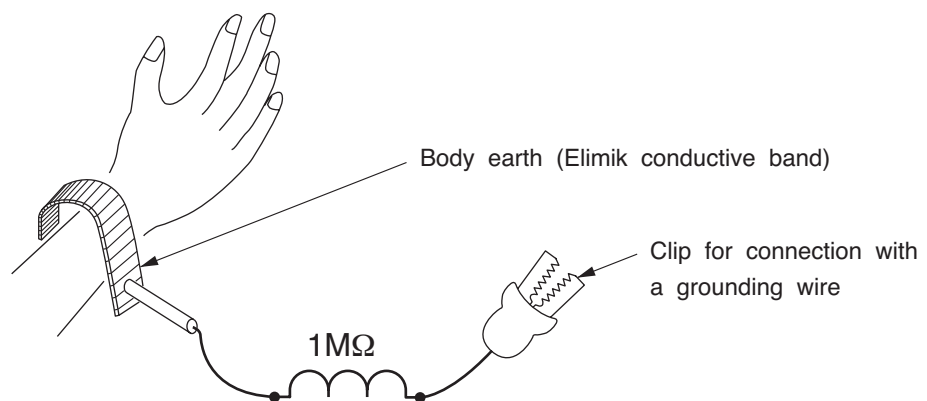
## 3. Items to be observed in handling

- (1) Use a conductive container for carrying and storing of parts. (Even rejected goods should be handled in the same way.)



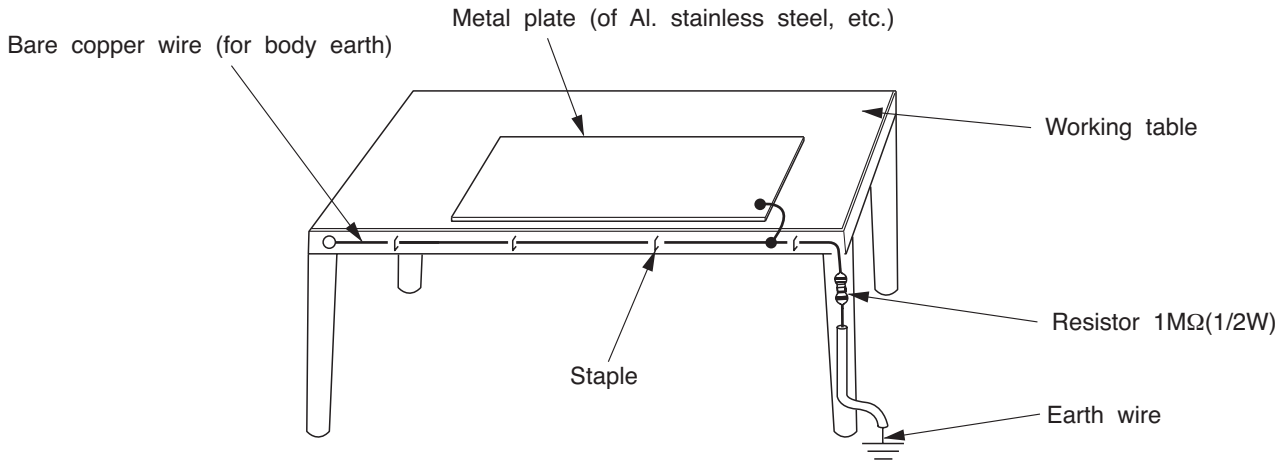
**Fig. 1 Conductive container**

- (2) When any part is handled uncovered (in counting, packing and the like), the handling person must always use himself as a body earth. (Make yourself a body earth by passing one M ohm earth resistance through a ring or bracelet.)
- (3) Be careful not to touch the parts with your clothing when you hold a part even if a body earth is being taken.
- (4) Be sure to place a part on a metal plate with grounding.
- (5) Be careful not to fail to turn off power when you repair the printed circuit board. At the same time, try to repair the printed circuit board on a grounded metal plate.

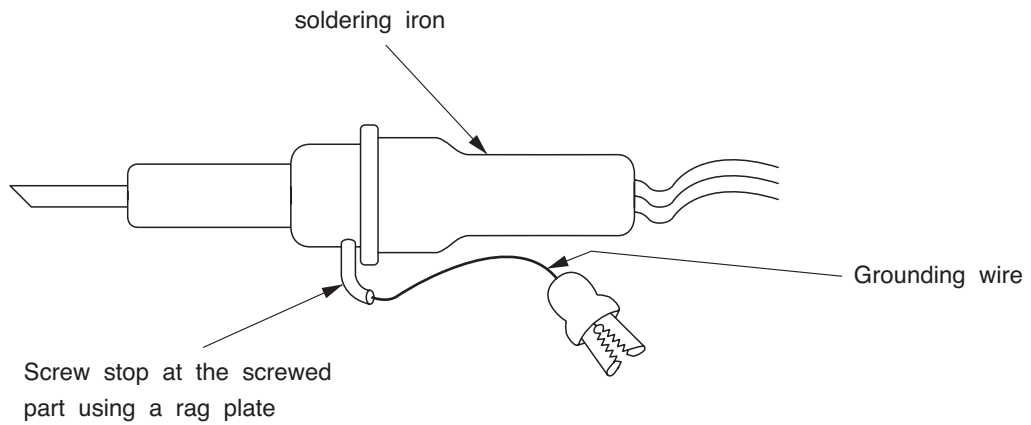


**Fig. 2 Body earth**

(6) Use a three wire type soldering iron including a grounding wire.



**Fig.3 Grounding of the working table**



**Fig.4 Grounding a solder iron**

Use a high insulation mode (100V, 10MΩ or higher) when ordinary iron is to be used.

(7) In checking circuits for maintenance, inspection, or some others, be careful not to have the test probes of the measuring instrument short circuit a load circuit or the like.



 **CAUTION**

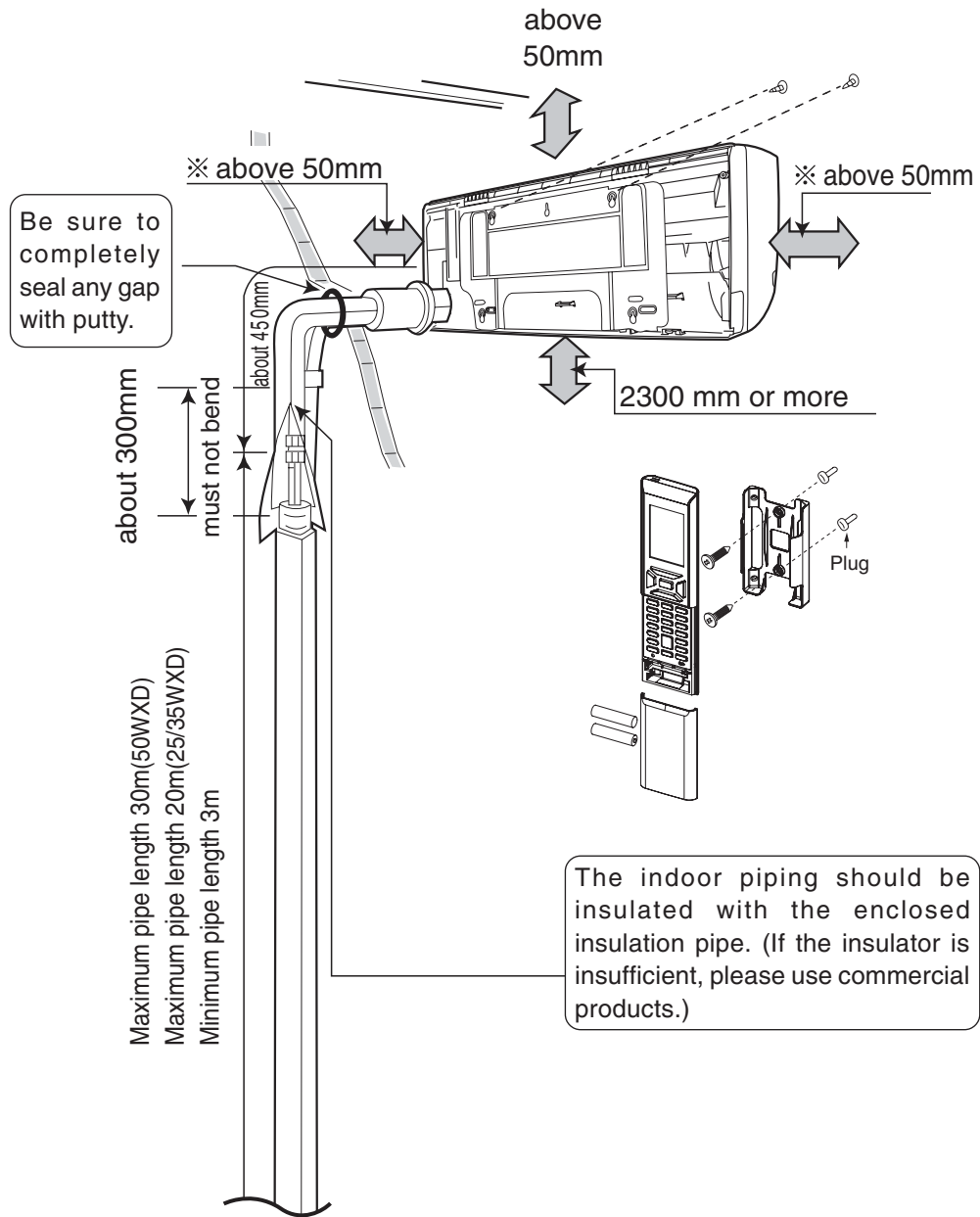
1. In quiet or stop operation, slight flowing noise of refrigerant in the refrigerating cycle is heard occasionally, but this noise is not abnormal for the operation.
2. When it thunders near by, it is recommend to stop the operation and turn off the circuit breaker for safety.
3. In the event of power failure, the room air conditioner will restart automatically in the previously selected mode once the power is restored. In the event of power failure during TIMER operation, the room air conditioner will not start automatically. Re-press ON/OFF button after 3 minutes from when the unit off or power recovery.
4. If the room air conditioner is stopped by adjusting thermostat, or missoperation, and re-start in a moment, there is occasion that the cooling and heating operation does not start for 3 minutes, it is not abnormal and this is the result of the operation of IC delay circuit. This IC delay circuit ensures that there is no danger of blowing fuse or damaging parts even if operation is restarted accidentally.
5. This room air conditioner should not be used at the cooling operation when the outside temperature is below  $-10^{\circ}\text{C}$  ( $14^{\circ}\text{F}$ ).
6. This room air conditioner (the reverse cycle) should not be used when the outside temperature is below  $-20^{\circ}\text{C}$  ( $5^{\circ}\text{F}$ ).  
If the reverse cycle is used under this condition, the outside heat exchanger is frosted and efficiency falls.
7. When the outside heat exchanger is frosted, the frost is melted by operating the hot gas system, it is not trouble that at this time fan stops and the vapour may rise from the outside heat exchanger.

## SPECIFICATIONS

MODEL	RAK-18QXD,RAK-25RXD,RAK-35RXD,RAK-50RXD	
FAN MOTOR	30W (DC325V)	
FAN MOTOR CAPACITOR	NO	
FAN MOTOR PROTECTOR	NO	
COMPRESSOR	-	
COMPRESSOR MOTOR CAPACITOR	NO	
OVERLOAD PROTECTOR	NO	
OVERHEAT PROTECTOR	NO	
FUSE (for MICROPROCESSOR)	3.15A	
POWER RELAY	NO	
POWER SWITCH	YES	
TEMPORARY SWITCH	YES	
SERVICE SWITCH	NO	
TRANSFORMER	YES	
VARISTOR	TVR10471	
NOISE SUPPRESSOR	NO	
THERMOSTAT	YES(IC)	
REMOTE CONTROL SWITCH (LIQUID CRYSTAL)	YES	
REFRIGERANT CHARGING VOLUME (Refrigerant R32)	PIPES	WITHOUT REFRIGERANT BECAUSE COUPLING IS FLARE TYPE.

Figure showing the installation of Indoor unit

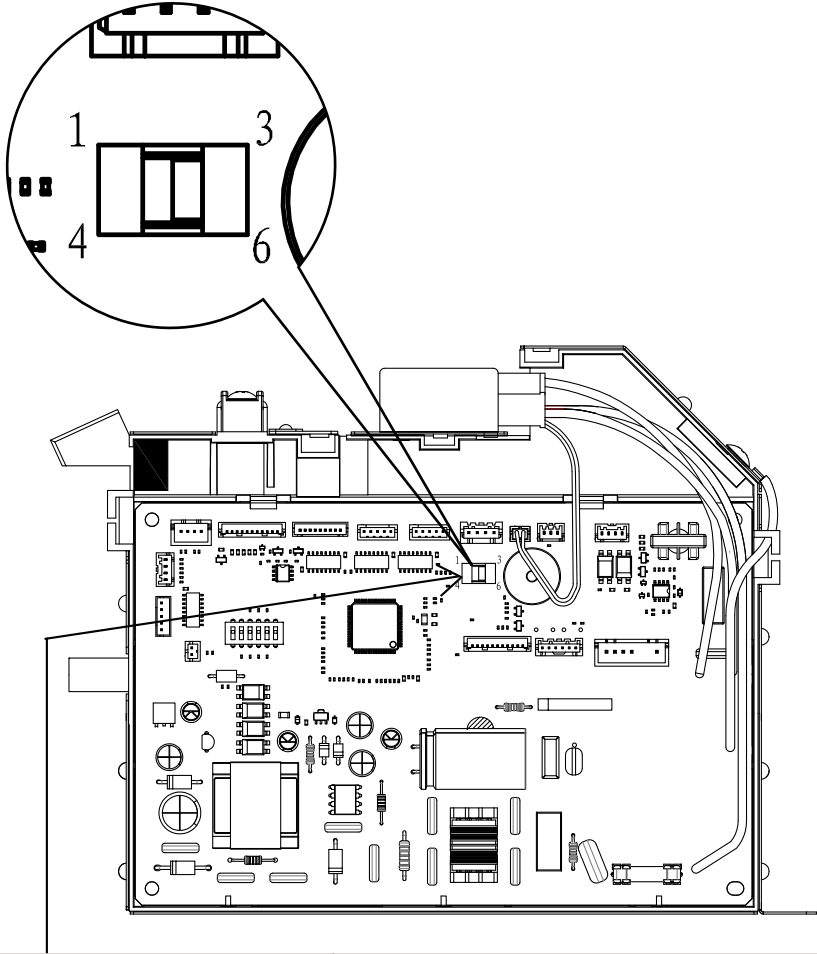
MODEL RAK-18QXD  
 RAK-25RXD  
 RAK-35RXD  
 RAK-50RXD



# SWITCH SETTING TO SELECT 1.8kW OR 1.2kW CAPACITY

**! CAUTION**

Before setting the switch, make sure to turn OFF power supply and then set the position of the switch otherwise will cause damage to the Main PCB.



SWITCH POSITION		CAPACITY SELECTION	
1.2kW		1.8kW	1.2kW
1.2kW		1.8kW	1.8kW

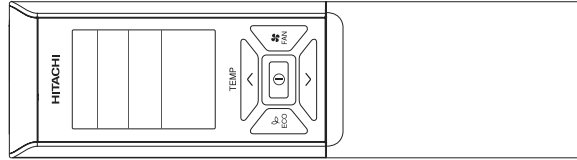
**NOTE:**  
**FACTORY** default setting is at 1.8kW capacity.  
 This setting is applicable for RAK-18QXD only.

# HITACHI

## Remote Controller Manual

MODEL

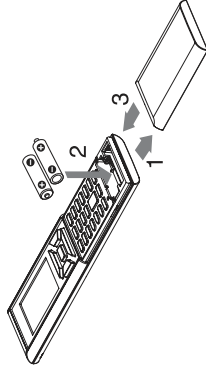
RAR-6N1



SUOMI NEDERLANDS SVENSKA Ελληνικά PORTUGUÊS ESPAÑOL ITALIANO FRANÇAIS DEUTSCH ENGLISH

### PREPARATION BEFORE OPERATION

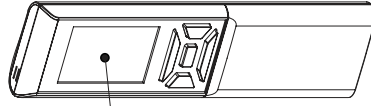
#### ■ To install the batteries



1. Slide the cover to take it off.
2. Install two dry batteries AAA-LR03 (alkaline). The direction of the batteries should match the marks in the case.
3. Replace the cover at its original position.

#### ■ To fix the remote controller holder to the wall

1. Choose a place from where the signals can reach the unit.
2. Fix the remote controller holder to a wall, a pillar or similar location with the provided screws.
3. Place the remote controller in the remote controller holder.



Remote controller



Remote controller holder

Screws

#### NOTE

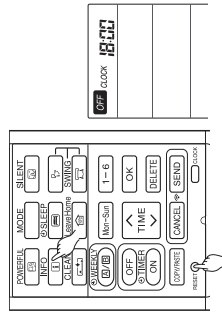
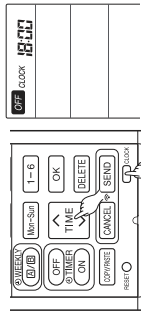
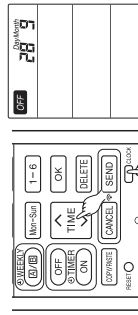
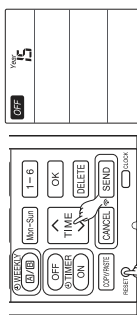
##### Notes on batteries

- When replacing the batteries, use batteries of the same type, and replace both old batteries together.
  - When the system is not used for a long time, take the batteries out.
  - The batteries will last for approximately 1 year. However, if the remote controller display begins to fade and degradation of reception performance occurs within a year, replace both batteries with new size AAA-LR03 (alkaline).
  - The attached batteries are provided for the initial use of the system.
- The usable period of the batteries may be short depending on the manufactured date of the air conditioner.

##### Notes on the remote controller

- Never expose the remote controller to direct sunlight.
- Dust on the signal transmitter or receiver will reduce the sensitivity. Wipe off dust with soft cloth.
- Signal communication may be disabled if an electronic-starter-type fluorescent lamp (such as inverter-type lamps) is in the room. Consult the shop if that is the case.
- If the remote controller signals happen to operate another appliance, move that appliance to somewhere else, or consult the service shop.
- When the remote controller is not in use, please close the slide cover to prevent failure.

## PREPARATION BEFORE OPERATION



### To set calendar and clock

1. Press **RESET** (RESET) button when first time setting. "Year" blinks.
2. Press **TIME** (TIME) button to set the current year.
3. Press **CLOCK** (CLOCK) button. "Day" and "Month" blink.
4. Press **TIME** (TIME) button to set the current day and month.
5. Press **CLOCK** (CLOCK) button. "CLOCK" blinks.
6. Press **TIME** (TIME) button to set the clock to the current time.
7. Press **CLOCK** (CLOCK) button.

Calendar and clock are set.

To modify the calendar and clock, press **CLOCK** (CLOCK) button.  
Then follow steps 1 to 7.

Calendar and clock need to be set again after changing batteries.

After changing the batteries,

1. Press **RESET** (RESET) button.
  2. Direct remote controller towards indoor unit and press **INFO** (INFO) button.
  3. The calendar and clock from indoor unit will be transmitted.
- Calendar and clock will not be transmitted from indoor unit when the following occurs:
- When there is a power failure.
  - When breaker is OFF by user (unit is not in STANDBY MODE).

### NOTE

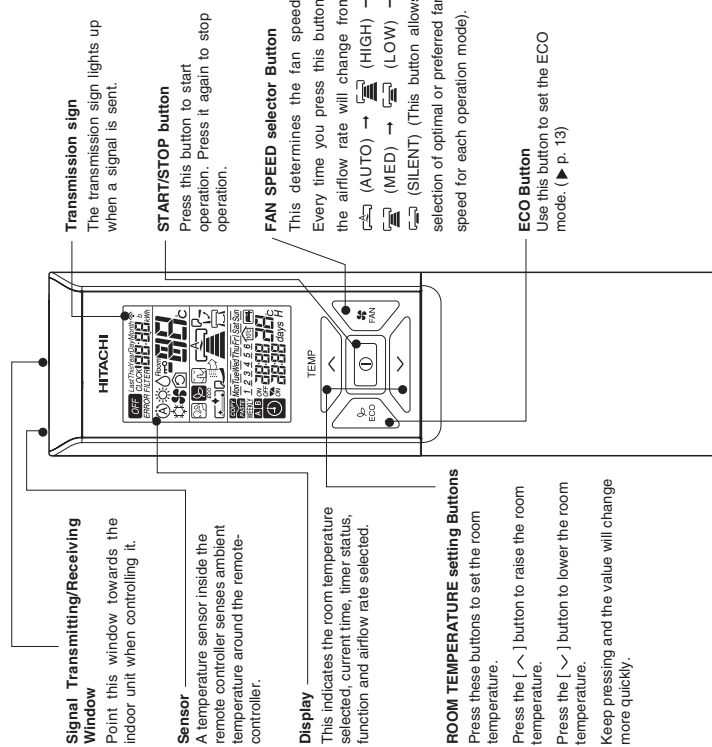
- Note on setting the calendar and clock.
- If the calendar and clock are not set, the ON-timer, OFF-timer and Weekly Timer cannot be set.
  - If the calendar and clock are not set correctly, the ON-timer, OFF-timer and Weekly Timer will not operate correctly.
  - When the ON-timer and Weekly Timer are set, the calendar and clock cannot be changed. If there is a need to change the calendar and clock, ON-timer, OFF-timer and Weekly Timer need to be cancelled.

## ENGLISH

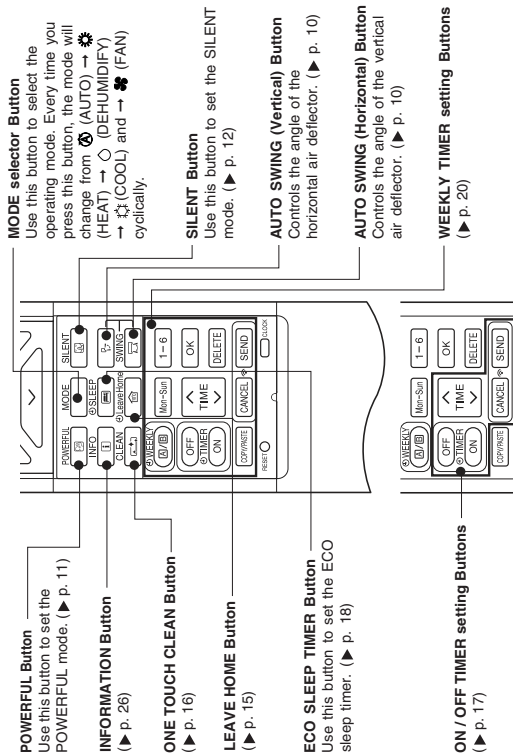
## NAMES AND FUNCTIONS OF REMOTE CONTROLLER

### REMOTE CONTROLLER

- This controls the operation of the indoor unit. The range of control is about 7 meters. If indoor lighting is controlled electronically, the range of control may be shorter.  
This unit can be fixed on a wall using the fixture provided. Before fixing it, make sure the indoor unit can be controlled from the remote controller.
- Handle the remote controller with care. Dropping it or getting it wet may compromise its signal transmission capability.
- After new batteries are inserted into the remote controller, the unit will initially require approximately 10 seconds to respond to commands and operate.
- When remote controller is not in use for about 3 minutes during OFF condition, indicated by **OFF** on the display, the LCD will turn off.
- During clock setting, the LCD will turn off about 10 minutes later if the remote controller is not in use.
- When pressing any button, the LCD will turn on.
- The LCD will not turn off during TIMER setting.



## NAMES AND FUNCTIONS OF REMOTE CONTROLLER



MODE SELECTOR	FAN	ON / OFF TIMER
AUTO	POWERFUL	ON / OFF TIMER
HEAT	SILENT	TIME
DEHUMIDIFY	INFO	OK
COOL	SLEEP TIMER	DELETE
FAN	AUTO SWING (VERTICAL)	COPY/PASTE
	AUTO SWING (HORIZONTAL)	CANCEL
	LEAVE HOME	SEND
	CLEAN	SEND
	DAY	CLOCK
	PROGRAM NO.	
	1-6	

**Precautions for Use**

- Do not put the remote controller in the following places.
  - Under direct sunlight.
  - In the vicinity of a heater.
- Handle the remote controller carefully. Do not drop it on the floor, and protect it from water.
- Once the outdoor unit stops, it will not restart for about 3 minutes (unless you turn the power switch off and on or unplugging the power cord and plug it in again).
- This is to protect the device and does not indicate a failure.
- If you press the MODE selector button during operation, the device may stop for about 3 minutes for protection.

## VARIOUS FUNCTIONS

### Auto Restart Control

- If there is a power failure, operation will be automatically restarted when the power is resumed with previous operation mode and airflow direction. (As the operation is not stopped by remote controller.)
  - If you intend not to continue the operation when the power is resumed, switch off the power supply.
  - When you switch on the circuit breaker, the operation will be automatically restarted with previous operation mode and airflow direction.
- Note: ... you do not require Auto Restart Control, please consult your sales agent.
2. Auto Restart Control is not available when Timer or Sleep Timer mode is set.

## AUTOMATIC OPERATION

The device will automatically determine the mode of operation, HEAT or COOL, depending on the current room temperature. The selected mode of operation will change when the room temperature varies. However, the mode of operation will not change when indoor unit is connected to multi type outdoor unit.

**1**  
Press the MODE selector button so that the display indicates the (AUTO) mode of operation.

- When AUTO has been selected, the device will automatically determine the mode of operation, HEAT or COOL, depending on the current room temperature. However, the mode of operation will not change when indoor unit is connected to multi type outdoor unit.
- If the mode automatically selected by the unit is not satisfactory, manually change the mode setting (HEAT, DEHUMIDIFY, COOL or FAN).

**2**  
Set the desired FAN SPEED with the (FAN SPEED) button (the display indicates the setting).

(AUTO) → (SILENT) ← (LOW) ← (MED) ← (HIGH) →

**3**  
Set the desired room temperature with the TEMPERATURE buttons (the display indicates the setting). The temperature setting and the actual room temperature may vary depending on conditions. Temperature range can be set between 16°C and 32°C.

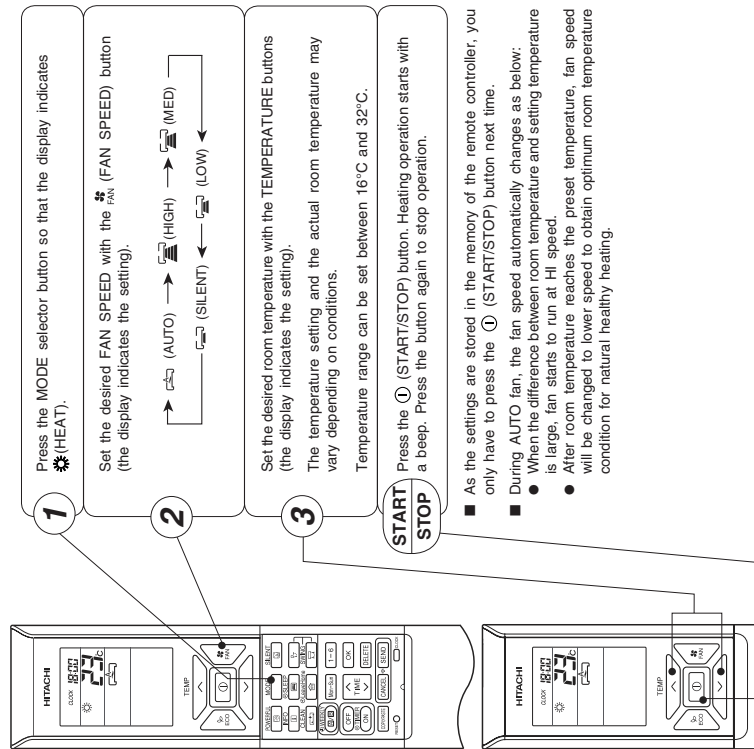
Press the (START/STOP) button. Operation starts with a beep. Press the button again to stop operation.

As the settings are stored in the memory of the remote controller, you only have to press the (START/STOP) button next time.

Press the (FAN SPEED) button to select AUTO, HIGH, MED, LOW or SILENT.

## HEATING OPERATION

- Use the device for heating when the outdoor temperature is under 21°C. When it is too warm (over 21°C), the heating function may not work in order to protect the device.
- In order to maintain reliability of the device, please use this device when outdoor temperature is above -15°C.

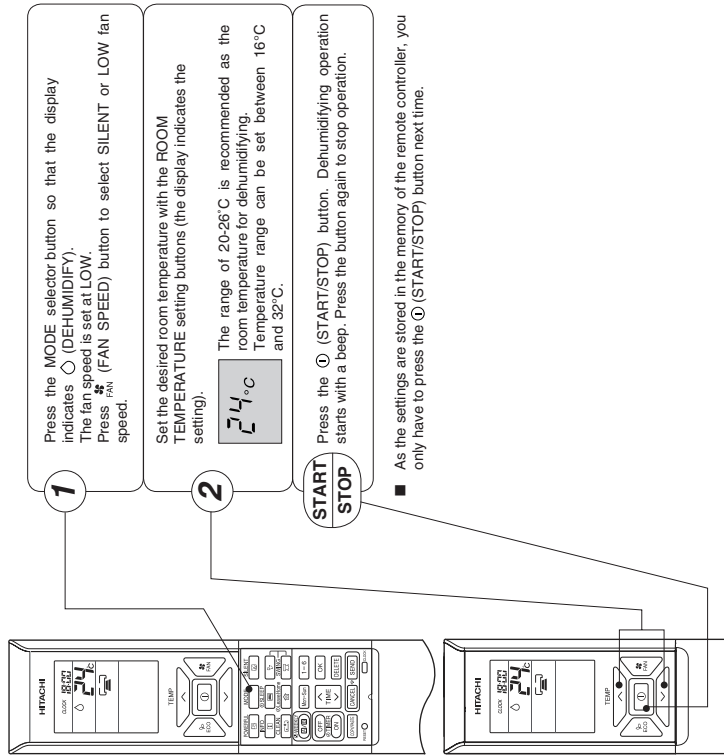


## Defrosting

Defrosting will be performed about once an hour when frost forms on the heat exchange of the outdoor unit, for 5-10 minutes each time.  
During defrosting operation, the operation lamp blinks in a cycle of 3 seconds on and 0.5 second off.  
The maximum time for defrosting is 20 minutes.  
However, if the indoor unit is connected to multi type outdoor unit, the maximum time for defrosting is 15 minutes.  
(If the piping length used is longer than usual, frost is likely to form.)

## DEHUMIDIFYING OPERATION

Use the device for dehumidifying when the room temperature is over 16°C. When it is under 15°C, the dehumidifying function will not work.



## Dehumidifying Function

- When the room temperature is higher than the temperature setting. The device will dehumidify the room, reducing the room temperature to the preset level.  
When the room temperature is lower than the temperature setting. Dehumidifying will be performed at the temperature setting slightly lower than the current room temperature, regardless of the temperature setting.
- The preset room temperature may not be reached depending on the number of people present in the room or other room conditions.



## COOLING OPERATION

Use the device for cooling when the outdoor temperature is -10~ -43°C. If indoors humidity is very high (80%), some dew may form on the air outlet grille of the indoor unit.

- 1 Press the MODE selector button so that the display indicates (COOL).
- 2 Set the desired FAN SPEED with the FAN SPEED button (the display indicates the setting).  
 (AUTO) → (HIGH) → (MED) → (LOW) → (SILENT) → (HIGH) → (MED) → (LOW) → (SILENT)
- 3 Set the desired room temperature with the TEMPERATURE buttons (the display indicates the setting).  
 The temperature setting and the actual room temperature may vary depending on conditions.  
 Temperature range can be set between 16°C and 32°C

Press the (START/STOP) button. Cooling operation starts with a beep. Press the button again to stop operation. The cooling function does not start if the temperature setting is higher than the current room temperature (even though the (OPERATION) lamp lights). The cooling function will start as soon as user set the temperature below the current room temperature.

■ As the settings are stored in the memory of the remote controller, you only have to press the (START/STOP) button next time.

■ During AUTO fan, the fan speed automatically changes as below:

- When the difference between room temperature and setting temperature is large, fan starts to run at HI speed.
- After room temperature reaches the preset temperature, fan speed will be changed to lower speed to obtain optimum room temperature condition for natural healthy cooling.

## FAN OPERATION

User can use the device simply as an air circulator.

- 1 Press the MODE selector so that the display indicates (FAN).
- 2 Set the desired FAN SPEED with the FAN SPEED button (the display indicates the setting).  
 (HIGH) → (MED) → (LOW) → (SILENT) → (HIGH) → (MED) → (LOW) → (SILENT)

Press the (START/STOP) button. Fan operation starts with a beep. Press the button again to stop operation.

## AUTO SWING OPERATION

### VERTICAL SWING

#### ■ To start Vertical Auto Swing

- Press (AUTO SWING (VERTICAL)) button. The deflector(s) will start to swing up and down.  
 (V) is displayed on the LCD.

#### ■ To cancel Vertical Auto Swing

- Press (AUTO SWING (VERTICAL)) button again. The deflector(s) will stop in the current position.  
 (V) disappeared from the LCD.

### HORIZONTAL SWING

#### ■ To start Horizontal Auto Swing

- Press (AUTO SWING (HORIZONTAL)) button. The deflectors will start to swing right and left.  
 (H) is displayed on the LCD.

#### ■ To cancel Horizontal Auto Swing

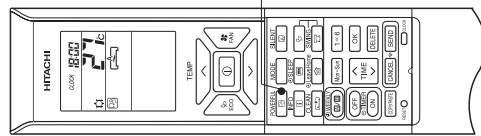
- Press (AUTO SWING (HORIZONTAL)) button again. The deflectors will stop in the current position.  
 (H) disappeared from the LCD.

### NOTE

- During cooling and dehumidifying operation, do not keep the deflectors swinging or in the lower position (in the case of vertical auto swing) for a long time. It may cause dew condensation on the deflectors.

## POWERFUL OPERATION

- By pressing **POWERFUL** (P) button during AUTO, HEATING, DEHUMIDIFYING, COOLING or FAN operation, the air conditioner performs at the maximum power.
- During POWERFUL operation, cooler or warmer air will be blown out from indoor unit for COOLING or HEATING operation respectively.



### To start POWERFUL operation

- Press **POWERFUL** (P) (POWERFUL) button during operation.  
"P" is displayed on the LCD.

POWERFUL operation ends in 20 minutes. Then the system automatically operates with the previous settings used before POWERFUL operation.

### To cancel POWERFUL operation

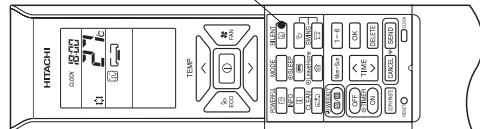
- Press the **START/STOP** (S) button. Or
- Press **POWERFUL** (P) (POWERFUL) button again.  
POWERFUL operation stops.  
"P" disappears from the LCD.

## NOTE

- When SLEEP mode, ECO mode, SILENT mode or LEAVE HOME mode is selected, POWERFUL operation is cancelled.
- During POWERFUL operation, capacity of the air conditioner will not increase
  - if the air conditioner is already running at maximum capacity.
  - just before defrost operation (when the air conditioner is running in HEATING operation).
- After auto restart, POWERFUL operation is cancelled and previous operation shall start.
- For multi model connections, POWERFUL operation may not function depending on operation conditions.

## SILENT OPERATION

- By pressing **SILENT** (S) (SILENT) button during AUTO, HEATING, DEHUMIDIFYING, COOLING or FAN operation, the fan speed will change to ultra slow.



### To start SILENT operation

- Press **SILENT** (S) (SILENT) button during operation.  
"S" is displayed on the LCD. Fan speed will be ultra slow.

### To cancel SILENT operation

- Press **START/STOP** (S) button. Or
- Press **SILENT** (S) (SILENT) button again or **FAN SPEED** (F) button.  
Fan speed will return to previous fan speed before SILENT operation starts.  
SILENT operation stops.  
"S" disappears from the LCD.

## NOTE

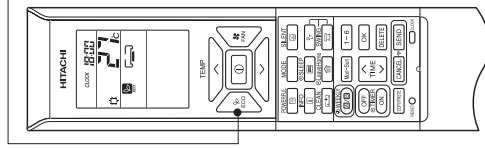
- When POWERFUL operation is selected, SILENT operation is cancelled. Fan speed will return to previous fan speed before SILENT operation.
- After auto restart, SILENT operation is cancelled. Fan speed will return to previous fan speed before SILENT operation.
- During any operation with fan speed **SILENT** (S) (SILENT), if press **SILENT** (S) (SILENT) button, fan speed will not change.

## ECO OPERATION

There are two kinds of ECO OPERATION with sensor or without sensor, depending on models. Please refer to [Names and Functions of each part] in the unit instruction manual to verify if your unit is equipped with a sensor and read the following instruction on ECO Operation accordingly.

### ECO OPERATION

ECO operation is an energy saving function by changing set temperature automatically and by limiting the maximum power consumption value.



1

- By pressing the (ECO) button during AUTO, HEATING, DEHUMIDIFYING or COOLING operation, the air conditioner performs the "ECO" operation.

#### To start ECO operation

- Press (ECO) button during operation. " " is displayed on the LCD. A beep sound is emitted from indoor unit. Energy saving operation will start by changing the set temperature higher or lower automatically and reducing operation power consumption. This function may vary based on the connected outdoor unit.

#### To cancel ECO operation

- Press (START/STOP) button. Or
- Press (ECO) button again. " " disappears from the LCD. A beep sound is emitted from indoor unit.

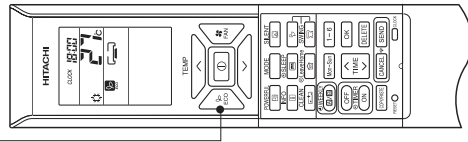
#### NOTE

- ECO function will not be effective when power consumption is low.
- By pressing (POWERFUL) button, ECO operation is cancelled.
- After auto restart, ECO operation is cancelled and previous operation mode shall start.
- For multi model connections, energy saving operation shall start only by changing set temperature higher or lower automatically. However, effectiveness of ECO depends on operation conditions.

## ECO OPERATION

### ECO OPERATION with sensor

The sensor detects the presence of people in the room. When nobody is detected, the unit automatically starts energy saving operation by shifting the set temperature in two steps.



1

- By pressing the (ECO) button during AUTO, HEATING, DEHUMIDIFYING or COOLING operation, the air conditioner performs the "ECO" operation.

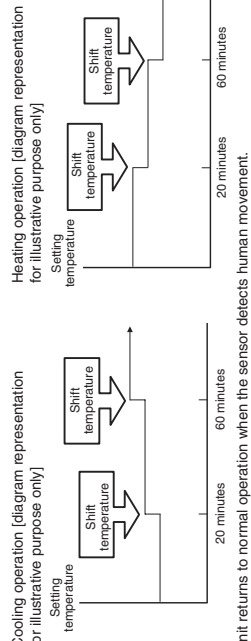
#### To start ECO operation

- Press (ECO) button during operation. " " is displayed on the LCD. A beep sound is emitted from indoor unit and the (ECO) lamp on the indoor unit lights up. The sensor starts to detect the presence of people in the room.

#### To cancel ECO operation

- Press (START/STOP) button. Or
- Press (ECO) button again. " " disappears from the LCD. A beep sound is emitted from indoor unit and the (ECO) lamp on the indoor unit turns off.

When the presence of people is not detected for 20 minutes, the set temperature is automatically shifted for energy saving. If nobody is in the room for 60 minutes, the set temperature is shifted further.



The unit returns to normal operation when the sensor detects human movement.

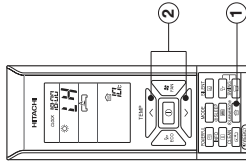
#### NOTE

- By pressing (POWERFUL) button, ECO operation is cancelled.
- After auto restart, ECO operation is cancelled and previous operation mode shall start.

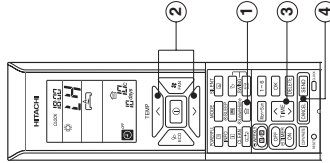
## LEAVE HOME (LH) OPERATION

Prevent the room temperature from falling too much when no one is at home. The initial setting temperature is 10°C and the temperature range can be set between 10°C and 16°C. This operation is able to operate by "Continuous operation" or "Day timer operation". Please use "Day timer operation" to set the number of days up to 99 days.

### Continuous operation



### Day timer operation



### To start LEAVE HOME operation

#### Option 1. Continuous operation.

- 1 Press **LEAVE HOME** (LEAVE HOME) button during stop or operation. Room temperature is set at 10°C and heating operation starts.
- 2 Set the desired room temperature with the **TEMPERATURE** buttons. Temperature range can be set between 10°C and 16°C.

#### Option 2. Day timer operation.

- 1 Press **LEAVE HOME** (LEAVE HOME) button during stop or operation. Room temperature is set at 10°C and heating operation starts. Set the desired room temperature with the **TEMPERATURE** buttons. Temperature range can be set between 10°C and 16°C.
- 2 Press **TIME** (TIME) button to select number of days. Number of days blink.
  - \* Press **UP** (UP) or **DOWN** (DOWN) to set number of days from 1 day to 99 days.
  - \* Number of day is counted when clock indicates 0:00.
- 3 Press **SEND** (SEND) button to confirm number of operation days. Display for number of operation days will stop blinking. Press **CANCEL** (CANCEL) button to reset number of operation days or to have continuous operation.

### To cancel LEAVE HOME operation

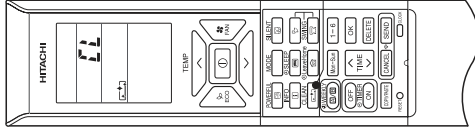
- Press **START/STOP** button. Or
- Press **LEAVE HOME** (LEAVE HOME) button again. Return to previous operation mode. Or
- Change to other operation mode by pressing **MODE** (MODE) button.

### NOTE

- After reaching the set number of operation days for Leave Home or by pressing the (Leave Home) button again, the unit will operate in previous mode.
- During Leave Home operation, fan speed and horizontal air deflector position cannot be changed.
- By pressing (Leave Home) button, implementation of Weekly Timer or Once Timer is cancelled.
- In case of power supply shut down, after autostart, all setting for number of days operation will be reset and unit shall be in continuous operation.
- **POWERFUL**, **SILENT** and **ECO** operations are not applicable during Leave Home operation.
- For multi connection
  - **FAN/COOLING/DEHUMIDIFYING** and **Leave Home** cannot operate at the same time.
  - The first-run unit has a priority and other units in different mode will be in standby mode.
- Heating operation can be used with **Leave Home**.
- When two or more rooms are set to operate **Leave Home**, the temperature set by **Leave Home** may not be reached. It also depends on outdoor temperature.

## CLEAN (ONE TOUCH CLEAN) OPERATION

Drying indoor heat exchanger after cooling operation to prevent mildew.



### To start CLEAN operation

- Press **CLEAN** (CLEAN) button when unit is OFF. Total time taken for One Touch Clean operation is 60 minutes. During this operation, **HEATING** or **FAN** operation shall operate. During one touch clean, operation lamp is blinking.

"CLEAN" is displayed on the LCD.

### To cancel CLEAN operation

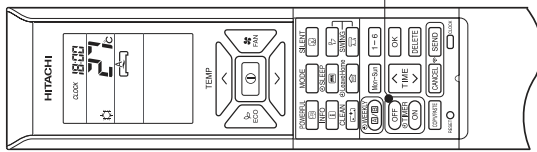
- Press **START/STOP** button. Or
- Press **CLEAN** (CLEAN) button again.

### NOTE

- When **CLEAN** operation finish, unit will switch OFF automatically.
- If Weekly Timer or Once Timer is set, there is a need to cancel those timer before operating **CLEAN** function.
- For multi connections, when pressing **CLEAN** (CLEAN) button, operation is limited to **FAN** operation.
- For multi connections, when one room operates **CLEAN** operation first, other rooms can operate **COOLING**, **DEHUMIDIFYING** or **FAN** operation. However, when other rooms need to operate **HEATING** operation, air conditioner will be in **STANDBY** mode. After **CLEAN** operation finish, **HEATING** operation will start.



## ONCE TIMER (ON/OFF TIMER) OPERATION



### OFF-TIMER

The device can be set to turn off at a preset time.

1. Press **OFF-TIMER** (OFF-TIMER) button. **OFF** and **0:00** blink on the display.
2. Set the "turn-off time" with **TIME** (TIME) button.
3. After setting, direct the remote controller towards the indoor unit and press **SEND** (SEND) button.  
**OFF** and "set time" lights up instead of blinking.  
A beep sound emitted from indoor unit and the (TIMER) lamp on the indoor unit lights up.

### ON-TIMER

The device will turn on at a designated time.

1. Press **ON-TIMER** (ON-TIMER) button. **ON** and **0:00** blink on the display.
2. Set the "turn-on time" with **TIME** (TIME) button.
3. After setting, direct the remote controller towards the indoor unit and press **SEND** (SEND) button.  
**ON** and "set time" light up instead of blinking.  
A beep sound emitted from indoor unit and the (TIMER) lamp on the indoor unit lights up.

### ON/OFF TIMER

- The device will turn on (off) and off (on) at the designated time.
- The switching occurs first at the preset time that comes earlier.
- The arrow mark appears on the display to indicate the sequence of switching operations.

1. Press **OFF-TIMER** (OFF-TIMER) button so that **OFF** and **0:00** blink on the display.
2. Set the "turn-off" time with **TIME** (TIME) button. After setting, direct the remote controller towards the indoor unit and press **SEND** (SEND) button.
3. Press **ON-TIMER** (ON-TIMER) button so that **ON** and set "turn-off" time light up. The **OFF** and **0:00** blink.
4. Set the "turn-on" time with **TIME** (TIME) button.
5. After setting, direct the remote controller towards the indoor unit and press **SEND** (SEND) button.  
**ON** and set "turn-on" time light up instead of blinking.  
A beep sound emitted from indoor unit and the (TIMER) lamp on the indoor unit lights up.

- The timer may be used in three ways: OFF-timer, ON-timer and ON/OFF (OFF/ON)-timer. Set the current time first because it serves as a reference.

### To cancel Reservation

- Point the signal window of the remote controller towards the indoor unit and press **CANCEL** (CANCEL) button. **ON** and "ON or OFF set time" goes out with a beep and the (TIMER) lamp on the indoor unit turns off.

### NOTE

- User can set only one of the OFF-timer, ON-timer or ON/OFF-timer.
- If WEEKLY TIMER already set, by setting the ONCE TIMER, ONCE TIMER operation is prioritized. When ONCE TIMER operation is complete, WEEKLY TIMER operation will be activated.



## ECO SLEEP TIMER OPERATION

The timer can be set up to a duration of 7 hours.

By pressing **ECO SLEEP** (SLEEP) button during AUTO, HEATING, DEHUMIDIFYING, COOLING or FAN operation, the unit shifts the room temperature and reduces the fan speed. It results in energy saving. Set the current time first before operating the ECO SLEEP TIMER operation.

### To start ECO SLEEP TIMER operation

- Press **ECO SLEEP** (SLEEP) button during operation.
- "ECO SLEEP", "OFF", "off time", "H" and number of hour are displayed on the remote controller display.
  - During ECO SLEEP TIMER operation, fan speed will be ultra slow.
  - A beep sound emitted from indoor unit and the (TIMER) lamp on the indoor unit lights up.

Pressing **ECO SLEEP** (SLEEP) button repeatedly, the number of hours will change as below:



- During ECO SLEEP TIMER operation, air conditioner will continue to operate for the designated number of hours and then turn off.
- When the ECO SLEEP TIMER has been set, the display on the remote controller indicates the turn off time.

**OFF** **19:00** **H**  
Example: If ECO SLEEP TIMER is set for 1 hour at 18:00, the switch off time will be at 19:00.

### To cancel ECO SLEEP TIMER operation

- Press **START/STOP** button.
- Room air conditioner will switch off.
- Press **ECO SLEEP** (SLEEP) button again until "ECO SLEEP" and number of hour disappear from the remote controller display.
- Press **CANCEL** (CANCEL) button.
- A beep sound emitted from indoor unit and the (TIMER) lamp on the indoor unit turns off.
  - SLEEP TIMER operation is cancelled.

### ECO SLEEP TIMER OPERATION

#### To set ECO SLEEP TIMER and ON TIMER

The air conditioner will be turned off by ECO SLEEP TIMER and turned on by ON TIMER.

1. Set the ON TIMER.
2. Press (SLEEP) button and set ECO SLEEP TIMER.



Example:  
In this case, air conditioner will turn off in 2 hours (at 1:38) and it will be turned on at 6:00 the next morning.

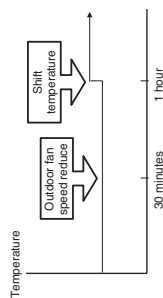
#### To cancel ECO SLEEP TIMER and ON TIMER operation

Direct the remote controller towards the indoor unit and press (CANCEL) button.

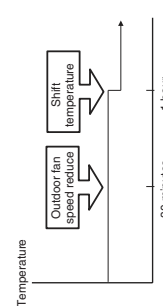
- "OFF", off time, "", number of hour, "ON" and ON TIMER set time disappear from the remote controller display.
- A beep sound emitted from indoor unit and the (TIMER) lamp on the indoor unit turns off.
- ECO SLEEP TIMER and ON TIMER reservations are cancelled.

30 minutes after setting ECO SLEEP TIMER, outdoor fan speed will be reduced to lower the noise level and to have comfort operation.  
1 hour after setting ECO SLEEP TIMER, set temperature will be slightly shifted. Amount of temperature shifted depends on type of air conditioner.  
These automatic operation changes contribute to energy saving without losing comfort.  
The level of energy consumption depends on outside temperature, room temperature, set temperature or air conditioner type.

Cooling operation [diagram representation for illustrative purpose only]



Heating operation [diagram representation for illustrative purpose only]



#### NOTE

- If ECO SLEEP TIMER is set when OFF TIMER or ON/OFF TIMER has been set earlier, the ECO SLEEP TIMER becomes effective instead of the OFF TIMER or ON/OFF TIMER.

### WEEKLY TIMER OPERATION

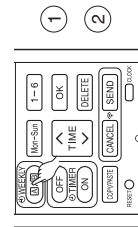
- It is possible to select Mode A or Mode B. For each mode, up to 6 programs can be set per day. In total, a maximum of 42 programs can be set for a week for each mode.
- If calendar and clock are not set, the reservation setting for WEEKLY TIMER cannot be set.
- If calendar and clock are not set correctly, WEEKLY TIMER will not operate correctly.
- Reservation for calendar and clock shall be set first before operating WEEKLY TIMER.

**Step 1 :** Set the reservation schedule to the remote controller. Send the registered reservation to indoor unit and then operate.

**Step 2 :** Select Mode A or Mode B and activate or deactivate WEEKLY TIMER .

**Step 3 :** Copy and cancel the reservation schedule.

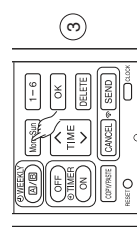
**Step 1 :** Set reservation schedule to the remote controller. Send the registered reservation to indoor unit and then operate.



- How to set a WEEKLY TIMER.
- 1. Select Mode A or Mode B  
Press (WEEKLY) button. WEEKLY lights up. **A** and **B** blink on the display. (Mode A is selected).  
Press (WEEKLY) button again, **B** and **C** blink on the display. (Mode B is selected).
- If no reservation has been made, ON/OFF, , , will not appear.
- If reservation has been made, ON/OFF, , , will not appear.

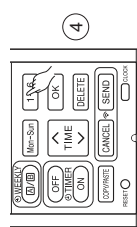
2. Set a program

Press (WEEKLY) button for about 3 seconds. The selection mode can be changed.  
**C**, day: Mon, program no. : 1, ON/OFF, setting time and setting temperature blink on the display.



3. Select the desired day of the week  
Press (DAY) button.  
The day changes from Mon → Tue → Wed → Thu → Fri → Sat → Sun → Mon, Tue, Wed, Thu, Fri, Sat, Sun [Full days] → Mon, Tue, Wed, Thu, Fri [weekday] → Sat, Sun [weekend] → Mon → Tue .....

Select [Full days] for daily reservation.  
Select [weekday] for Monday to Friday reservation.  
Select [weekend] for Saturday and Sunday reservation.  
• After reservation has been set, it is easy to check and edit at the same time.



4. Press button to select a program number.  
The number changes from 1 → 2 → 3 → 4 → 5 → 6 → 1 → 2 ....  
• If program number has been set, follow above in order to make changes.

**WEEKLY TIMER OPERATION**

5. Press **[ON/OFF TIMER]** (ON-OFF TIMER) button to select ON TIMER or OFF TIMER reservation.

6. Press **[TIME]** (TIME) button to set time reservation.

7. Press (TEMP  $\wedge$  or  $\vee$ ) button to set temperature reservation.

8. Press **[OK]** (OK) button. The reservations are set. Day, program number, ON reservation, setting temperature will light up. **②** will be continuously blinks. If reservation is not complete, settings will not be stored in memory.

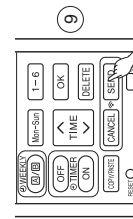
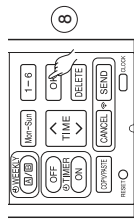
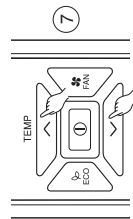
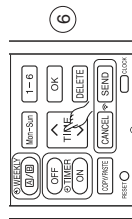
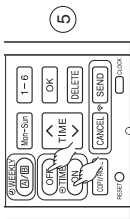
To continue with the reservation, press **[MEM-SUM]** **[1-6]** **[OFF/TIMER ON]** buttons. Follow step 3 to 8 for reservation.

9. After all the reservations have been set, press **[SEND]** (SEND) button while directing the remote controller towards the indoor unit for about 3 seconds. Timer lamp on the indoor unit will blink rapidly.

After beep sound emitted from indoor unit, TIMER lamp will light up. **Please ensure that the TIMER lamp lights up.**

This indicates that the reservation has been stored in the indoor unit and Timer function has been completed.

The reservation contents will appear on the remote controller display.



**NOTE**

- Up to 6 programs can be set per day. Setting ON TIMER or OFF TIMER for each program number can be at random. When pressing **[SEND]** (SEND) button, the set ON TIMER or OFF TIMER for each program number will automatically arranged so that program number 1 shall have the earliest time and program number 6 shall have the latest time.
- CAUTION !** If the remote controller is left idle and **[SEND]** (SEND) button is not pressed within 3 minutes after reservations have been made , all current reservations will be lost.

**WEEKLY TIMER OPERATION**

**Step 2: Select Mode A or Mode B and activate or deactivate WEEKLY TIMER.**

1. How to select Mode A or Mode B of WEEKLY TIMER setting.

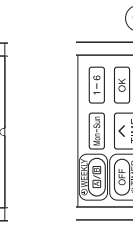
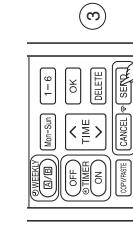
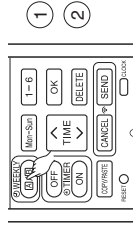
1. Press **[WEEKLY]** (WEEKLY) button. **A** and **②** blink on the display. (Normally Mode A will blink first).

2. Press **[WEEKLY]** (WEEKLY) button again. **B** and **③** blink on the display.

3. Select Mode A or Mode B. Press **[SEND]** (SEND) button while directing the remote controller towards the indoor unit for about 3 seconds. Timer lamp on the indoor unit will blink rapidly.

After beep sound emitted from indoor unit, TIMER lamp will light up. **Please ensure that the TIMER lamp lights up.**

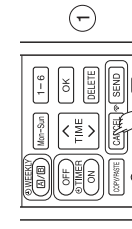
This indicates that Mode A or Mode B selection and active WEEKLY TIMER have been confirmed.



1. Setting non-active WEEKLY TIMER .

1. Direct the remote controller towards the indoor unit and press **[CANCEL]** (CANCEL) button. Beep sound will be emitted from indoor unit and TIMER lamp will be OFF. Reservation indication on remote display will also disappear. This indicates that non-active WEEKLY TIMER has been confirmed.

• To activate back the setting of WEEKLY TIMER , repeat the steps for "How to select Mode A or Mode B of WEEKLY TIMER setting".



**NOTE**

- When setting ONCE TIMER, operation of WEEKLY TIMER is interrupted. After ONCE TIMER operation is complete, WEEKLY TIMER operation will be activated.
- When ONCE TIMER is cancelled, operation of WEEKLY TIMER is also cancelled. Need to set WEEKLY TIMER operation for activation.
- After auto restart, WEEKLY TIMER operation is cancelled. Need to set WEEKLY TIMER operation for activation.




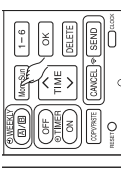
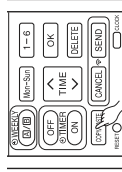
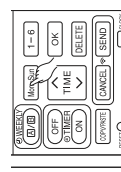
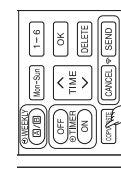

**WEEKLY TIMER OPERATION**

**Step 3: Copy and cancel the reservation schedule.**

- How to copy and paste.  
Editing the reservation schedule is easy by copying data from one day to another day.

1. Press **[WEEKLY]** (WEEKLY) button to select Mode A or Mode B.
2. Press **[WEEKLY]** (WEEKLY) button for about 3 seconds to start editing the reservation schedule.
3. Press **[Mon-Sun]** (DAY) button to select a day of the week to copy.
4. Press **[COPY/PASTE]** (COPY/PASTE) button. Then "PASTE" blinks on the display.  
\* Press **[CANCEL]** (CANCEL) button to cancel the COPY mode. Normal setting mode is activated.
5. Press **[Mon-Sun]** (DAY) button to select a day of the week to paste.
6. Press **[COPY/PASTE]** (COPY/PASTE) button one more time to paste. **[PASTE]** only blinks on the display.
7. To continue copying to other days, press **[Mon-Sun]** or **[1-6]** or **[1-6]** or **[1-6]**. Then start from step 3.
8. After copy and paste completed, press **[SEND]** (SEND) button while directing the remote controller towards the indoor unit for about 3 seconds. Timer lamp on the indoor unit will blink rapidly.  
After beep sound emitted from indoor unit, TIMER lamp will light up.  
**Please ensure that the TIMER lamp lights up.**  
If TIMER lamp does not light up, Press **[SEND]** (SEND) button again.

- Reservation data will not change if **[SEND]** (SEND) button is not pressed.

**NOTE**

- If there is no reservation data, copying data from one day to another day cannot be done.

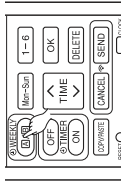
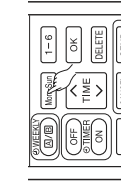
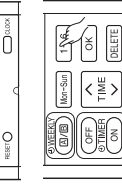
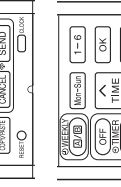

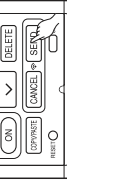
**WEEKLY TIMER OPERATION**

**Step 3: Copy and cancel the reservation schedule.**

- How to delete WEEKLY TIMER data.  
[Delete one program number reservation]

1. Press **[WEEKLY]** (WEEKLY) button to select Mode A or Mode B.
2. Press **[WEEKLY]** (WEEKLY) button for 3 seconds to start editing the reservation schedule.
3. Press **[Mon-Sun]** (DAY) button to select a day of the week to edit.
4. Press **[1-6]** to select program number. Selected program number will blink.
5. Press **[DELETE]** (DELETE) button. Reservation of selected program number is deleted.
6. After deleting, press **[SEND]** (SEND) button while directing the remote controller towards the indoor unit for about 3 seconds. Timer lamp on the indoor unit will blink rapidly.  
After beep sound emitted from indoor unit, TIMER lamp will light up.  
**Please ensure that the TIMER lamp lights up.**

- Reservation will not change if **[SEND]** (SEND) button is not pressed.

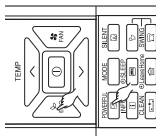











## OPERATION MODE LOCK

The remote controller can be set to fix the HEATING mode (including FAN), COOLING mode (including FAN) and DEHUMIDIFYING mode (including FAN) operations.



- Method to lock HEATING mode (including FAN) operation.  
Press **ECO** (ECO) and **POWERFUL** (POWERFUL) buttons simultaneously for about 5 seconds when the remote controller is OFF.

"**HEATING**", "**FAN**" and "**POWERFUL**" will be displayed for about 10 seconds. Later, "**HEATING**" and "**POWERFUL**" will remain.

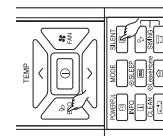
This indicates that HEATING mode operation is locked.



- When pressing **MODE** (MODE) button, "**HEATING**" or "**FAN**" will be displayed.

- Method to unlock HEATING mode (including FAN) operation.

Press **ECO** (ECO) and **POWERFUL** (POWERFUL) buttons simultaneously for about 5 seconds when the remote controller is OFF.  
All operation mode symbols will appear on the display for about 10 seconds. After that, operation mode symbol before cancellation will be displayed.  
This indicates that HEATING mode operation is unlocked.



- Method to lock COOLING and DEHUMIDIFYING modes (including FAN) operations.

Press **ECO** (ECO) and **SILENT** (SILENT) buttons simultaneously for about 5 seconds when the remote controller is OFF.

"**COOLING**", "**DEHUMIDIFYING**" and "**SILENT**" will be displayed for about 10 seconds. Later, "**COOLING**" and "**SILENT**" will remain.

This indicates that COOLING and DEHUMIDIFYING mode operation is locked.

When pressing **MODE** (MODE) button, "**COOLING**" or "**SILENT**" will be displayed.

- Method to unlock COOLING and DEHUMIDIFYING modes (including FAN) operations.

Press **ECO** (ECO) and **SILENT** (SILENT) buttons simultaneously for about 5 seconds when the remote controller is OFF.

All operation mode symbols will appear on the display for about 10 seconds. After that, operation mode symbol before cancellation will be displayed.  
This indicates that COOLING and DEHUMIDIFYING modes operation is unlocked.


### NOTE

- Operation Mode Lock function will not activate if TIMER reservations activate.
- TIMER reservations shall be deactivated first. Then, Operation Mode Lock function can be activated.
- HEATING, COOLING and DEHUMIDIFYING mode (including FAN) operations can be unlocked by pressing the **RESET** (RESET) button. However, by pressing the **RESET** (RESET) button, all the information stored in the remote controller will disappear. You may need to set the necessary information again.
- For multi connections, unit and mode which is set to lock HEATING and switched on first shall have higher priority. Other units which are chosen to operate at different modes shall be in STANDBY until either the first unit operation is switched off or the mode is selected to be same as the first unit.

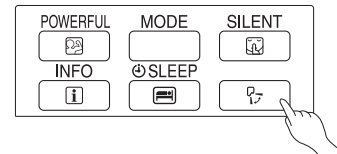


## AUTO SWING OPERATION


### ■ To start Vertical Auto Swing

- Press  (AUTO SWING (VERTICAL)) button. The deflector(s) will start to swing up and down.

 is displayed on the LCD.



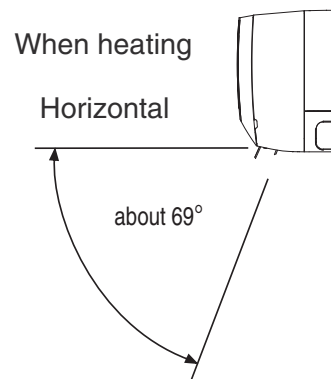
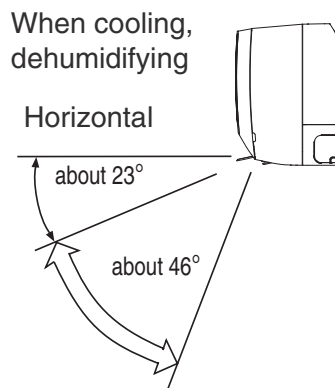
### ■ To cancel Vertical Auto Swing

- Press  (AUTO SWING (VERTICAL)) button again. The deflector(s) will stop in the current position.

 disappeared from the LCD.

#### NOTE

- During cooling and dehumidifying operation, do not keep the deflectors swinging or in the lower position (in the case of vertical auto swing) for a long time. It may cause dew condensation on the deflectors.




#### ⚠ CAUTION



- When operating the unit in cooling operation with the air deflector facing down and moving automatically for a long period of time, water will be condensed on the air deflector and drips down occasionally. This will wet your furniture.


## SAFETY PRECAUTION


- Please read the "Safety Precaution" carefully before operating the unit to ensure correct usage of the unit.
- Pay special attention to signs of "▲ Warning" and "▲ Caution". The "Warning" section contains matters which, if not observed strictly, may cause death or serious injury. The "Caution" section contains matters which may result in serious consequences if not observed properly. Please observe all instructions strictly to ensure safety.
- The signs indicate the following meanings. (The following are examples of signs.)

- ④ Make sure to connect earth line.  This sign in the figure indicates prohibition.
- ④ Indicates the instructions that must be followed.
- Please keep this manual after reading.

### PRECAUTIONS DURING INSTALLATION

- Do not reconstruct the unit.  
Water leakage, fault, short circuit or fire may occur if you reconstruct the unit by yourself. 
- Please ask your sales agent or qualified technician for the installation of your unit.  
Water leakage, short circuit or fire may occur if you install the unit by yourself.
- Please use earth line.  
Do not place the earth line near water or gas pipes, lightning-conductor, or the earth line of telephone. Improper installation of earth line may cause electric shock or fire. 
- Be sure to use the specified piping set for R410A/R32. Otherwise, this may result in broken copper pipes or faults.






- A circuit breaker should be installed depending on the mounting site of the unit.  
Without a circuit breaker, the danger of electric shock exists. 
- Do not install the unit near a location where there is flammable gas.  
The outdoor unit may catch fire if flammable gas leaks around it.

- Please ensure smooth flow of water when installing the drain hose.
- Make sure that a single phase 220V/230V power source is used.  
The use of other power sources may cause electrical components to overheat and lead to fire. 

### PRECAUTIONS DURING SHIFTING OR MAINTENANCE
















- Should abnormal situation arise (like burning smell), please stop operating the unit and turn off the circuit breaker. Contact your agent. Fault, short circuit or fire may occur if you continue to operate the unit under abnormal situation.
- Please contact your agent for maintenance. Improper self maintenance may cause electric shock and fire.
- Please contact your agent if you need to remove and reinstall the unit. Electric shock or fire may occur if you remove and reinstall the unit yourself improperly.

### PRECAUTIONS DURING OPERATION

- Avoid an extended period of direct airflow for your health. 
- Do not put objects like thin rods into the panel of blower and suction side because the high-speed fan inside may cause danger. 
- Do not use any conductor as fuse wire, this could cause fatal accident. 
- During thunder storm, disconnect the plug top and turn off the circuit breaker. 
- Spray cans and other combustibles should not be located within a meter of the air outlets of both indoor and outdoor units.  
As a spray can's internal pressure can be increased by hot air, a rupture may result. 

## ENGLISH

### PRECAUTIONS DURING OPERATION

- The product shall be operated under the manufacturer specification and not for any other intended use. 
- Do not attempt to operate the unit with wet hands, this could cause fatal accident. 
- When operating the unit with burning equipments, regularly ventilate the room to avoid oxygen insufficiency. 
- Do not direct the cool air coming out from the air-conditioner panel to face household/heating apparatus as this may affect the working of apparatus such as the electric kettle, oven etc. 
- Please ensure that outdoor mounting frame is always stable, firm and without defect. If not, the outdoor unit may collapse and cause danger. 
- Do not wash the unit with water or place a water container such as a vase on the indoor unit.  
Electrical leakage could be present and cause electric shock. 
- Do not place plants directly under the airflow as it is bad for the plants. 
- Be sure to stop the operation by using the remote controller and turn off the circuit breaker during cleaning, the high-speed fan inside the unit may cause danger. 
- Turn off the circuit breaker if the unit is not be operated for a long period. 
- Do not climb on the outdoor unit or put objects on it. 
- When operating the unit with the door and windows opened, (the room humidity is always above 60%) and with the air deflector facing down or moving automatically for a long period of time, water will condense on the air deflector and drips down occasionally. This will wet your furniture. Therefore, do not operate under such condition for a long time. 
- If the amount of heat in the room is above the cooling or heating capability of the unit (for example: more people entering the room, using heating equipments and etc.), the preset room temperature cannot be achieved. 
- Indoor unit cleaning must be performed by authorized personnel only. Consult your sales agent.  
Using a commercially available detergent or similar can damage the plastic parts or clog the drain pipe, causing water to drip with potential electric shock hazard. 
- Do not touch the air outlet, bottom surface and aluminium fin of the outdoor unit.  
You may get hurt. 
- Do not touch the refrigerant pipe and connecting valve.  
Burns may result. 
- This appliance is not to be used by children or persons with reduced physical, sensory or mental capabilities, or lack of experience and knowledge, unless they have been given supervision or instruction. Children must be supervised not to play with the appliance.

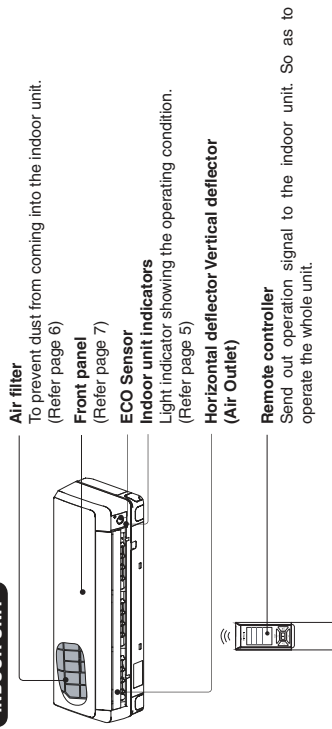
### ▲ CAUTION

### OPERATING RANGE

Operation mode	Cooling / Dehumidifying	Heating
Outdoor temperature	-10 to 43°C	-20 to 21°C

### NAMES AND FUNCTIONS OF EACH PART

#### INDOOR UNIT



**Air filter**  
To prevent dust from coming into the indoor unit. (Refer page 6)

**Front panel**  
(Refer page 6)

**ECO Sensor**  
Indoor unit indicators  
(Refer page 5)

**Horizontal deflector Vertical deflector (Air Outlet)**  
Light indicator showing the operating condition. (Refer page 5)

**Remote controller**

Send out operation signal to the indoor unit. So as to operate the whole unit.

#### MODEL NAME AND DIMENSIONS

MODEL	WIDTH (mm)	HEIGHT (mm)	DEPTH (mm)
RAK-18QXD, RAK-25RXD, RAK-35RXD, RAK-50RXD	900	295	210

#### NOTE FOR MULTI SYSTEM

Several indoor units can be connected to one outdoor unit. You can operate only one unit or several units according to your needs.

#### Combination of operations:

When operation mode is selected:

- You cannot operate the indoor units in the following combinations.

One unit	Other unit
Heating	Cooling
	Dehumidifying
	Fan

During automatic operation

- When heating operation is automatically selected for the first indoor unit, the next indoor unit will then start to heat. Also, if cooling or dehumidifying is automatically selected for the first indoor unit, the next indoor unit will also start to cool or dehumidify.

#### Adjusting the number of indoor units:

Decrease the number of indoor units to be operated especially when it is very hot or very cold or when you want to reach the preset temperature quickly.

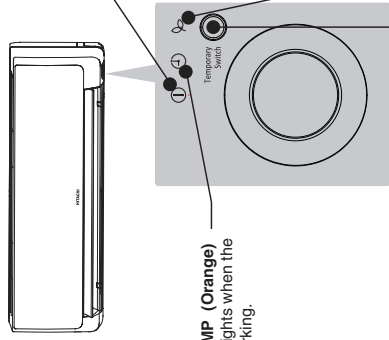


#### Stopped indoor units:

When an indoor unit is operated in the cooling, heating or dehumidifying mode in one room, the sound of refrigerant flow may be heard from a stopped indoor unit or a stopped indoor unit may become warm. This is because the indoor unit returns refrigerant to the outdoor unit to be ready for operation.

### NAMES AND FUNCTIONS OF EACH PART

#### INDOOR UNIT INDICATIONS



**TIMER LAMP (Orange)**  
This lamp lights when the timer is working.

**OPERATION LAMP (Yellow)**  
This lamp lights during operation. The OPERATION LAMP flashes in the following cases during heating.

- During preheating**  
For about 2-3 minutes after starting up.
- During defrosting**  
Defrosting will be performed about once an hour when frost forms on the heat exchanger of the outdoor unit, for 5-10 minutes each time.

**ECO Sensor Lamp (Green)**

#### TEMPORARY SWITCH

Use this switch to start and stop when the remote controller does not work.

- By pressing the temporary switch, the operation is done in automatic mode.
- When the operation is done using the temporary switch after the power source is turned off and turn on again, the operation is done in automatic mode.

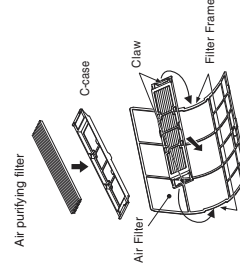
#### CAUTION

Turn off the circuit breaker if the unit is not be operated for a long period.

- If the power stays on and the unit is not operated, power is slightly consumed in the control circuit. The power is saved by turning off the power switch (or the circuit breaker) when the power is supplied from the outdoor unit.

#### Attaching the air purifying filters (Accessories) to the filter frame.

- Attach the air purifying filters to the C-case by gently compress its both sides, and release after insertion into filter frame.
- The cooling capacity is slightly weakened and the cooling speed becomes slower when the air purifying filters are used.
- The air purifying filters are not washable. It is recommended to use vacuum to clean. It can be used for 1 year. When you want to renew it, please ask your sales agent.



## MAINTENANCE

### CAUTION

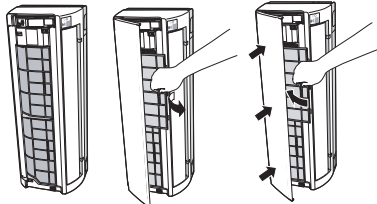
Cleaning and maintenance must be carried out only by qualified service personnel. Before cleaning, stop operation and switch off the power supply.

### 1. AIR FILTER

Please clean the filter once about every two weeks. By doing so, the power rates are saved. In case the air filter is full of dust, the air flow will decrease and the cooling capacity will be reduced. Further, noise may occur. Be sure to clean the filter following the procedure below.

#### PROCEDURE

● Open the front panel carefully and remove the filter.



● Vacuum dust from the air filter using vacuum cleaner. If there is too much dust, wash the filter with a detergent and rinse it thoroughly. After that, dry it in the shade.



● Set the filter with "FRONT" mark facing front, and slot them into the original state.  
 • After attaching the filters, push the front panel at three arrow portions as shown in figure and close it.

### CAUTION

- Do not wash with hot water at more than 40°C. The filter may shrink.
- When washing it, shake off moisture completely and dry it in the shade, do not expose it directly to the sun. The filter may shrink.
- Don't operate the unit without filter. Fault may occur if you continue.

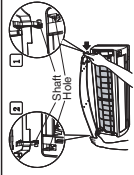
### 2. CLEANING OF FRONT PANEL

- Remove the front panel and wash with clean water. Wash it with a soft sponge. After using neutral detergent, wash thoroughly with clean water.
- When front panel is not removed, wipe it with a soft dry cloth. Wipe the remote controller thoroughly with a soft dry cloth.
- Wipe the water thoroughly. If water remains at indicators or signal receiver of indoor unit, it causes trouble.

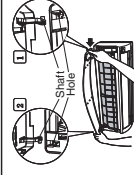


Method of removing the front panel.  
 Be sure to hold the front panel with both hands to detach and attach it.

#### Removing the Front Panel



#### Attaching the Front Panel



- When the front panel is fully opened with both hands, push the right arm to the inside to release it, and while closing the front panel slightly, put it out forward.
- Move the shafts of the left and right arms into the steps in the unit and securely insert them into the holes.

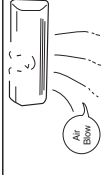
### CAUTION

- Do not splash or direct water to the body of the unit when cleaning it as this may cause short circuit.
- Never use hot water (above 40°C), benzene, gasoline, acid, thinner or a brush, because they will damage the plastic surface and the coating.



### 3. MAINTENANCE AT BEGINNING OF LONG OFF PERIOD

- Run the unit by setting the operation mode to **★ (FAN)** and the fan speed to **H1** for about half a day on a fine day, and dry the whole of the unit.
- Switch off the power plug or turn off the circuit breaker.



## INFORMATION

### CAPABILITIES

- This room air conditioner utilizes a heat pump system that absorbs exterior heat and brings it into a room to be heated. As the ambient temperature gets lower, heating capability will also lower. In such a situation, the inverter work to increase compressor rpm to keep the unit's heating capability from decreasing. If the unit's heating performance is still unsatisfactory, other heating appliances should be used to augment this unit's performance.
- The air conditioner is designed to heat an entire room so that it may take some time before you feel warm. Timer operation is recommended for effective preheating ahead of the desired time.



### CAUTION

Do not use a stove or any other high temperature devices in proximity to the indoor unit.

- If the heat present in a room exceeds the unit's cooling capacity (for example, if there are many people in the room or other heating appliances are used), the preset room temperature may not be reached.

### REFRIGERANT INFORMATION

- For the refrigerant charge information, please refer to the outdoor unit installation manual or specification label.

## REGULAR INSPECTION

PLEASE CHECK THE FOLLOWING POINTS EVERY EITHER HALF YEARLY OR YEARLY. CONTACT YOUR SALES AGENT SHOULD YOU NEED ANY HELP.

1		<b>WARNING</b>	<b>Check to see if the unit's earth line has been connected correctly.</b> If the earth line is disconnected or faulty, unit failure or electric shock hazard may result.
2		<b>WARNING</b>	<b>Check to see if the mounting frame has rusted extensively or if the outdoor unit has tilted or become unstable.</b> It could collapse or fall, causing injury.

## AFTER SALES SERVICE AND WARRANTY

WHEN ASKING FOR SERVICE, CHECK THE FOLLOWING POINTS.

CONDITION	CHECK THE FOLLOWING POINTS
<p>If the remote controller is not transmitting a signal. (Remote controller display is dim or blank.)</p> <p>When it does not operate.</p> <p>When it does not cool well. When it does not heat well.</p>	<ul style="list-style-type: none"> <li>• Do the batteries need replacement?</li> <li>• Is the polarity of the inserted batteries correct?</li> <li>• Is the fuse all right?</li> <li>• Is the voltage extremely high or low?</li> <li>• Is the circuit breaker "ON"?</li> <li>• Is the power plug inserted?</li> <li>• Do you have any power cut?</li> <li>• Is the air filter blocked with dust?</li> <li>• Is the set temperature suitable?</li> <li>• Have horizontal air deflectors been adjusted to their correct positions according to the operation mode selected?</li> <li>• Are the air inlets or air outlets of indoor and outdoor units blocked?</li> <li>• Is the fan speed "LOW" or "SILENT"?</li> </ul>

The following phenomena do not indicate unit failure.

<p>During heating, the operation indicator blinks and air blow stops</p> <p>Hissing or fizzy sounds</p> <p>Squeaking noise</p> <p>Rustling noise</p> <p>Clicking noise</p>	<p>&lt;Operation start&gt; The unit is preparing to blow warm air. Please wait. &lt;In operation&gt; The outdoor unit is defrosting. Please wait. Refrigerant flow noise in the pipe or valve sound generated when flow rate is adjusted. Noise generated when the unit expands or contracts due to temperature changes. Noise generated with the indoor unit fan's rpm changing such as operation start times. Noise of the motorized valve when the unit is switched on.</p>
--	--





Perking noise	Noise of the ventilation fan sucking in air present in the drain hose and blowing out defumifying water that had accumulated in the condensed water collector. For details, consult your sales agent.
Changing operation noise	Operation noise changes due to power variations according to room temperature changes.
Mist emission	Mist is generated as the air within the room is suddenly cooled by conditioned air.
Steam emitted from the outdoor unit	Water generated during defrosting operation evaporates and steam is emitted.
Odors	Caused as the smells and particles of smoke, food, cosmetics, etc. present in room air become attached to the unit and blown off into the room again.
The outdoor unit continues to operate even if operation is stopped.	Defrosting is underway (as the heating operation is stopped, the microcomputer checks frost accumulated in the outdoor unit and instructs the unit to perform automatic defrosting if necessary).
The OPERATION lamp is blinking.	Shows preheating or defrosting operation is underway. As the protective circuit or preheat sensor operates when unit operation is stopped during preheating and then restarted, or when operation mode is switched from cooling to heating, the lamp continues to blink.
Does not reach the temperature setting	Actual room temperature may deviate slightly from the remote controller's temperature setting depending on the number of people in the room, indoor or outdoor conditions.


- If the unit still fails to operate normally after performing the above inspections, turn the circuit breaker off and contact your sales agent immediately.

**Contact your sales agent immediately if the following phenomena should occur**

- The circuit breaker switches off or the fuse blows frequently.
- The switch operation is not stable.
- Foreign matter or water accidentally enters the unit interior.
- The power cord gets excessively hot or its insulation is torn or stripped.
- TIMER lamp on the indoor unit display blinks.

( As the nature of the failure can be identified by the blinking cycle, check the blinking cycle before turning off the circuit breaker. )





**Notes**

- In quiet operation or stopping the running, the following phenomena may occasionally occur, but they are not abnormal for the operation.
  - Slight flowing noise of refrigerant in the refrigerating cycle.
  - Slight rubbing noise from the fan casing which is cooled and then gradually warmed as operation stops.
- The odor will possibly be emitted from the room air conditioner because the various odor, emitted by smoke, foodstuffs, cosmetics and so on, sticks to it. So please clean the air filter and the evaporator regularly to reduce the odor.

- Please contact your sales agent immediately if the air conditioner still fails to operate normally after the above inspections. Inform your agent of the model of your unit, production number, date of installation. Please also inform him regarding the fault.



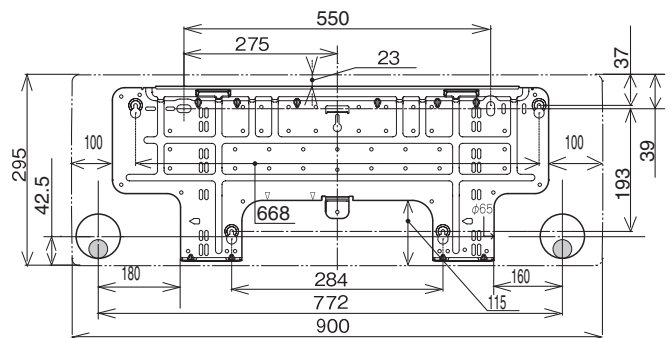
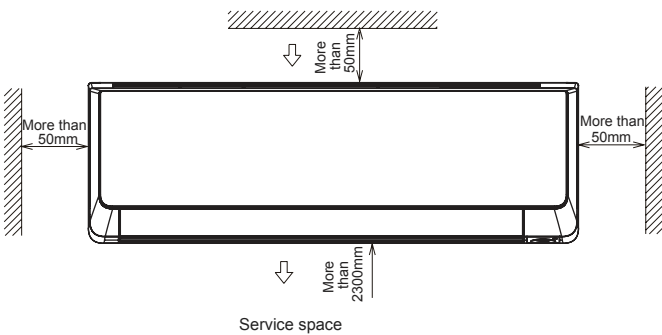
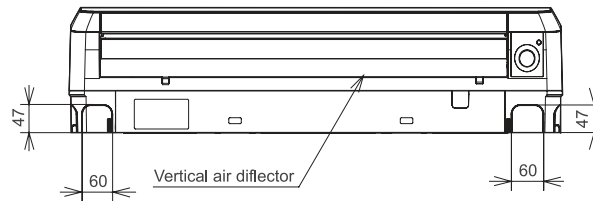
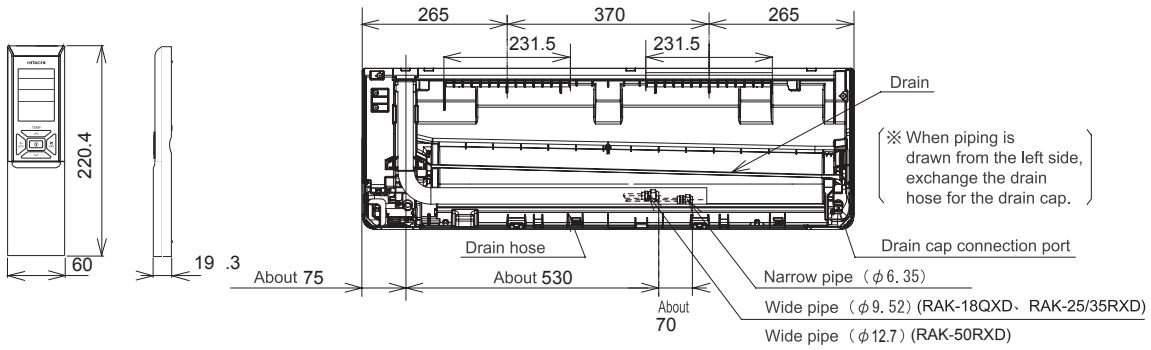
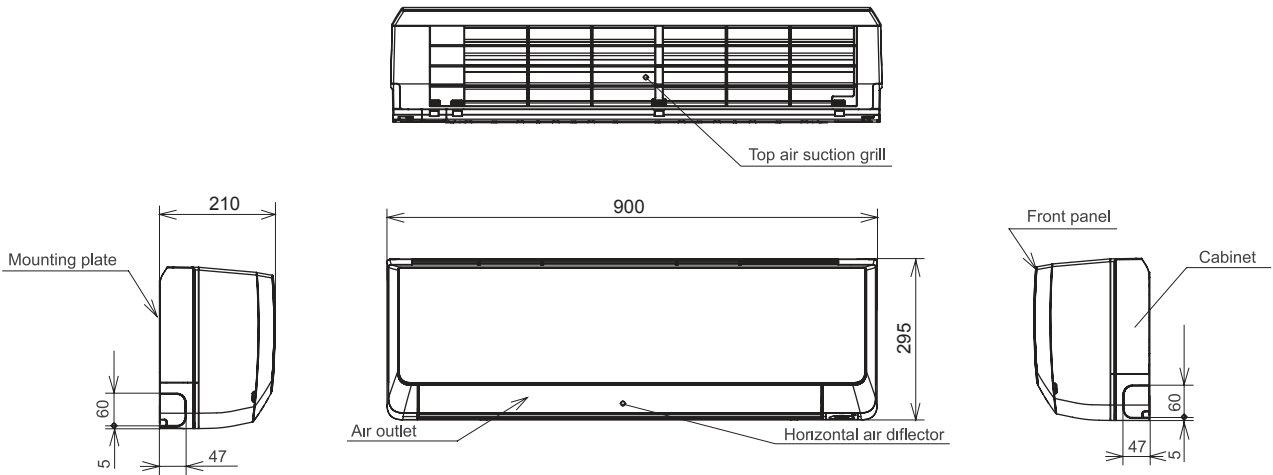


# CONSTRUCTION AND DIMENSIONAL DIAGRAM

MODEL RAK-18QXD, RAK-25RXD, RAK-35RXD, RAK-50RXD

## INDOOR UNIT

Unit : mm



# MAIN PARTS COMPONENT

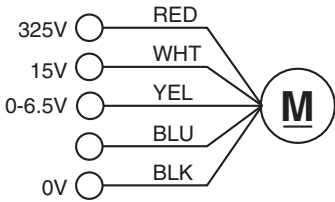
THERMOSTAT (Room temperature Thermistor)

## Thermostat Specifications

MODEL			RAK-18QXD,RAK-25RXD,RAK-35RXD,RAK-50RXD			
THERMOSTAT MODEL			IC			
OPERATION MODE			COOL		HEAT	
TEMPERATURE °C (°F)	INDICATION 16	ON	15.3	(59.54)	16.7	(62.06)
		OFF	15.0	(59.00)	16.7	(62.06)
	INDICATION 24	ON	23.3	(73.94)	24.7	(76.46)
		OFF	23.0	(73.40)	24.7	(76.46)
	INDICATION 32	ON	31.3	(88.34)	32.7	(90.86)
		OFF	31.0	(87.80)	32.7	(90.86)

## FAN MOTOR

### Fan Motor Specifications

MODEL	RAK-18QXD,RAK-25RXD,RAK-35RXD,RAK-50RXD
POWER SOURCE	DC : 325V
OUTPUT	30W
CONNECTION	 <p>(Control circuit built in)</p>

BLU : BLUE  
 GRY : GRAY  
 BLK : BLACK

YEL : YELLOW  
 ORN : ORANGE  
 PNK : PINK

BRN : BROWN  
 GRN : GREEN  
 VIO : VIOLET

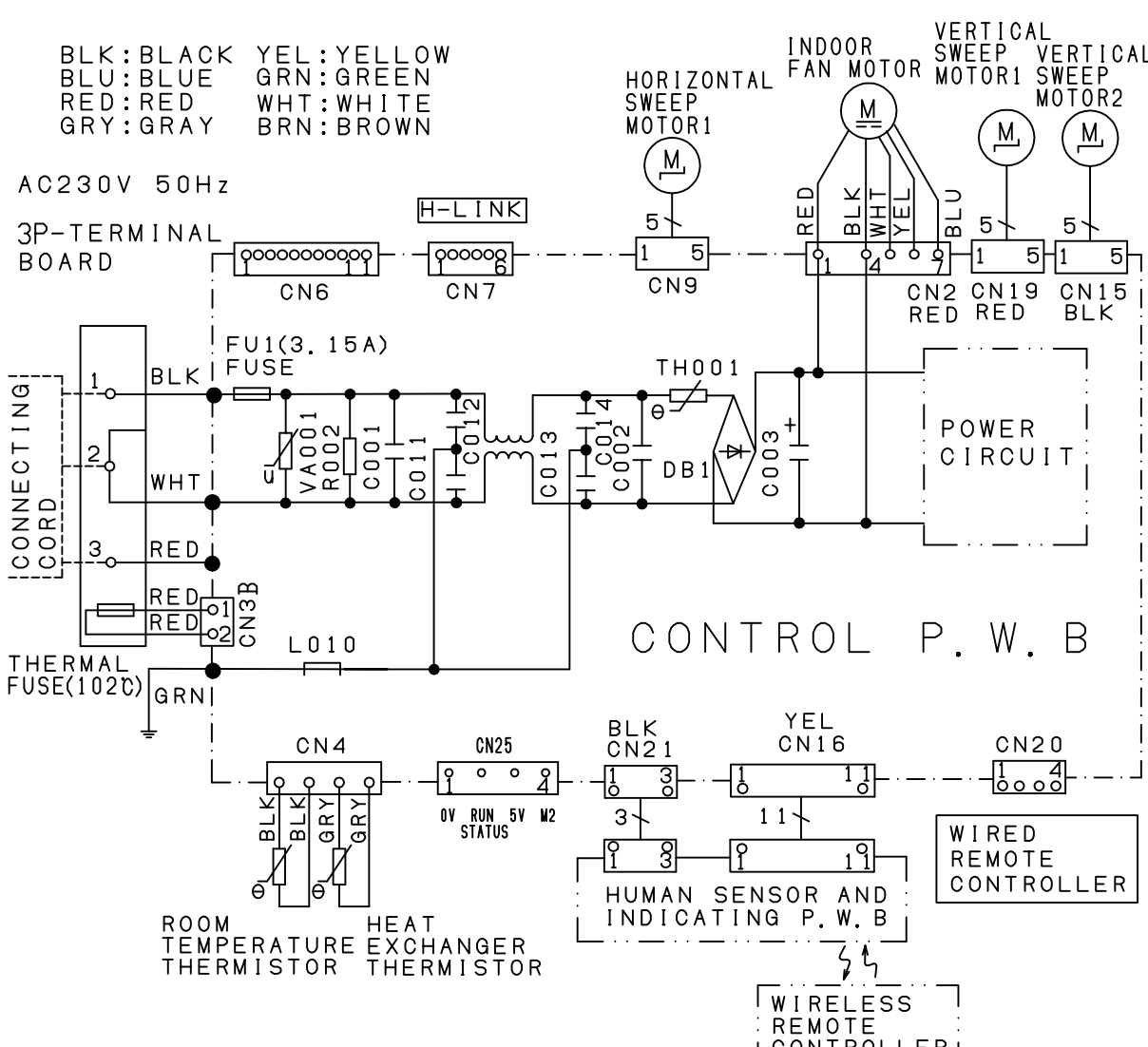
WHT : WHITE  
 RED : RED

# WIRING DIAGRAM

INDOOR UNIT

MODEL RAK-18QXD, RAK-25RXD, RAK-35RXD, RAK-50RXD

BLK: BLACK YEL: YELLOW  
 BLU: BLUE GRN: GREEN  
 RED: RED WHT: WHITE  
 GRY: GRAY BRN: BROWN

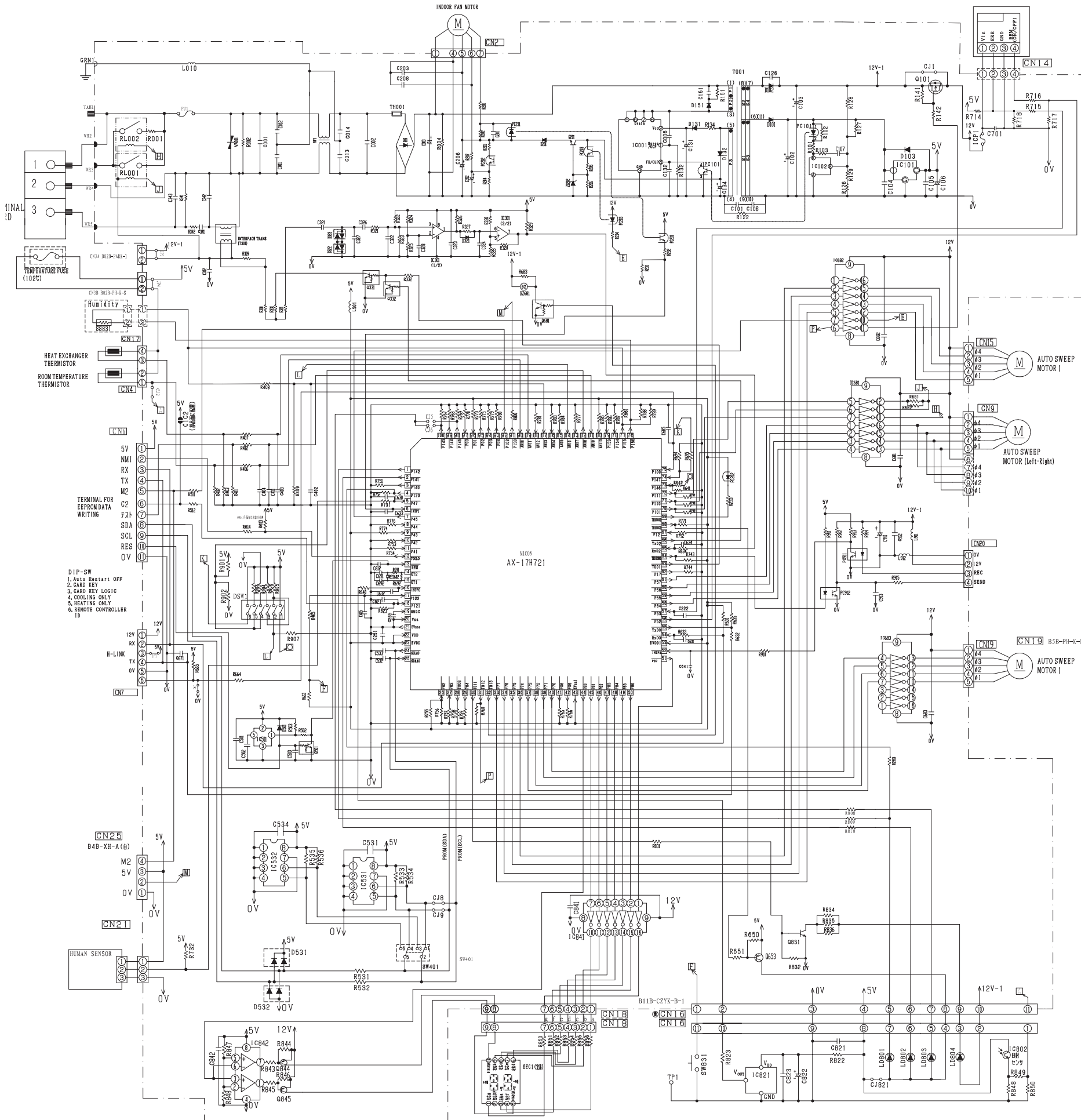


**CAUTION!** TURN OFF THE POWER SOURCE  
 HIGH VOLTAGE DURING THE SERVICE WORK.



# CIRCUIT DIAGRAM

MODEL RAK-18QXD



## RESISTOR

Part No.	Value	Unit	QTY	Remarks
R001	10K	Ω	1	RES
R002	10K	Ω	1	RES
R003	10K	Ω	1	RES
R004	10K	Ω	1	RES
R005	10K	Ω	1	RES
R006	10K	Ω	1	RES
R007	10K	Ω	1	RES
R008	10K	Ω	1	RES
R009	10K	Ω	1	RES
R010	10K	Ω	1	RES
R011	10K	Ω	1	RES
R012	10K	Ω	1	RES
R013	10K	Ω	1	RES
R014	10K	Ω	1	RES
R015	10K	Ω	1	RES
R016	10K	Ω	1	RES
R017	10K	Ω	1	RES
R018	10K	Ω	1	RES
R019	10K	Ω	1	RES
R020	10K	Ω	1	RES
R021	10K	Ω	1	RES
R022	10K	Ω	1	RES
R023	10K	Ω	1	RES
R024	10K	Ω	1	RES
R025	10K	Ω	1	RES
R026	10K	Ω	1	RES
R027	10K	Ω	1	RES
R028	10K	Ω	1	RES
R029	10K	Ω	1	RES
R030	10K	Ω	1	RES
R031	10K	Ω	1	RES
R032	10K	Ω	1	RES
R033	10K	Ω	1	RES
R034	10K	Ω	1	RES
R035	10K	Ω	1	RES
R036	10K	Ω	1	RES
R037	10K	Ω	1	RES
R038	10K	Ω	1	RES
R039	10K	Ω	1	RES
R040	10K	Ω	1	RES
R041	10K	Ω	1	RES
R042	10K	Ω	1	RES
R043	10K	Ω	1	RES
R044	10K	Ω	1	RES
R045	10K	Ω	1	RES
R046	10K	Ω	1	RES
R047	10K	Ω	1	RES
R048	10K	Ω	1	RES
R049	10K	Ω	1	RES
R050	10K	Ω	1	RES
R051	10K	Ω	1	RES
R052	10K	Ω	1	RES
R053	10K	Ω	1	RES
R054	10K	Ω	1	RES
R055	10K	Ω	1	RES
R056	10K	Ω	1	RES
R057	10K	Ω	1	RES
R058	10K	Ω	1	RES
R059	10K	Ω	1	RES
R060	10K	Ω	1	RES
R061	10K	Ω	1	RES
R062	10K	Ω	1	RES
R063	10K	Ω	1	RES
R064	10K	Ω	1	RES
R065	10K	Ω	1	RES
R066	10K	Ω	1	RES
R067	10K	Ω	1	RES
R068	10K	Ω	1	RES
R069	10K	Ω	1	RES
R070	10K	Ω	1	RES
R071	10K	Ω	1	RES
R072	10K	Ω	1	RES
R073	10K	Ω	1	RES
R074	10K	Ω	1	RES
R075	10K	Ω	1	RES
R076	10K	Ω	1	RES
R077	10K	Ω	1	RES
R078	10K	Ω	1	RES
R079	10K	Ω	1	RES
R080	10K	Ω	1	RES
R081	10K	Ω	1	RES
R082	10K	Ω	1	RES
R083	10K	Ω	1	RES
R084	10K	Ω	1	RES
R085	10K	Ω	1	RES
R086	10K	Ω	1	RES
R087	10K	Ω	1	RES
R088	10K	Ω	1	RES
R089	10K	Ω	1	RES
R090	10K	Ω	1	RES
R091	10K	Ω	1	RES
R092	10K	Ω	1	RES
R093	10K	Ω	1	RES
R094	10K	Ω	1	RES
R095	10K	Ω	1	RES
R096	10K	Ω	1	RES
R097	10K	Ω	1	RES
R098	10K	Ω	1	RES
R099	10K	Ω	1	RES
R100	10K	Ω	1	RES

## RESISTOR

Part No.	Value	Unit	QTY	Remarks
R101	10K	Ω	1	RES
R102	10K	Ω	1	RES
R103	10K	Ω	1	RES
R104	10K	Ω	1	RES
R105	10K	Ω	1	RES
R106	10K	Ω	1	RES
R107	10K	Ω	1	RES
R108	10K	Ω	1	RES
R109	10K	Ω	1	RES
R110	10K	Ω	1	RES
R111	10K	Ω	1	RES
R112	10K	Ω	1	RES
R113	10K	Ω	1	RES
R114	10K	Ω	1	RES
R115	10K	Ω	1	RES
R116	10K	Ω	1	RES
R117	10K	Ω	1	RES
R118	10K	Ω	1	RES
R119	10K	Ω	1	RES
R120	10K	Ω	1	RES
R121	10K	Ω	1	RES
R122	10K	Ω	1	RES
R123	10K	Ω	1	RES
R124	10K	Ω	1	RES
R125	10K	Ω	1	RES
R126	10K	Ω	1	RES
R127	10K	Ω	1	RES
R128	10K	Ω	1	RES
R129	10K	Ω	1	RES
R130	10K	Ω	1	RES
R131	10K	Ω	1	RES
R132	10K	Ω	1	RES
R133	10K	Ω	1	RES
R134	10K	Ω	1	RES
R135	10K	Ω	1	RES
R136	10K	Ω	1	RES
R137	10K	Ω	1	RES
R138	10K	Ω	1	RES
R139	10K	Ω	1	RES
R140	10K	Ω	1	RES
R141	10K	Ω	1	RES
R142	10K	Ω	1	RES
R143	10K	Ω	1	RES
R144	10K	Ω	1	RES
R145	10K	Ω	1	RES
R146	10K	Ω	1	RES
R147	10K	Ω	1	RES
R148	10K	Ω	1	RES
R149	10K	Ω	1	RES
R150	10K	Ω	1	RES

## Capacitor

Part No.	Value	Unit	QTY	Remarks
C001	1000µF	F	1	CAP
C002	1000µF	F	1	CAP
C003	1000µF	F	1	CAP
C004	1000µF	F	1	CAP
C005	1000µF	F	1	CAP
C006	1000µF	F	1	CAP
C007	1000µF	F	1	CAP
C008	1000µF	F	1	CAP
C009	1000µF	F	1	CAP
C010	1000µF	F	1	CAP
C011	1000µF	F	1	CAP
C012	1000µF	F	1	CAP
C013	1000µF	F	1	CAP
C014	1000µF	F	1	CAP
C015	1000µF	F	1	CAP
C016	1000µF	F	1	CAP
C017	1000µF	F	1	CAP
C018	1000µF	F	1	CAP
C019	1000µF	F	1	CAP
C020	1000µF	F	1	CAP
C021	1000µF	F	1	CAP
C022	1000µF	F	1	CAP
C023	1000µF	F	1	CAP
C024	1000µF	F	1	CAP
C025	1000µF	F	1	CAP
C026	1000µF	F	1	CAP
C027	1000µF	F	1	CAP
C028	1000µF	F	1	CAP
C029	1000µF	F	1	CAP
C030	1000µF	F	1	CAP
C031	1000µF	F	1	CAP
C032	1000µF	F	1	CAP
C033	1000µF	F	1	CAP
C034	1000µF	F	1	CAP
C035	1000µF	F	1	CAP
C036	1000µF	F	1	CAP
C037	1000µF	F	1	CAP
C038	1000µF	F	1	CAP
C039	1000µF	F	1	CAP
C040	1000µF	F	1	CAP
C041	1000µF	F	1	CAP
C042	1000µF	F	1	CAP
C043	1000µF	F	1	CAP
C044	1000µF	F	1	CAP
C045	1000µF	F	1	CAP
C046	1000µF	F	1	CAP
C047	1000µF	F	1	CAP
C048	1000µF	F	1	CAP
C049	1000µF	F	1	CAP
C050	1000µF	F	1	CAP

Symbol Shape

A	Axial
R	Radial
H	Manual
C	Chip

Photocoupler

Part No.	Value	Unit	QTY	Remarks
PC101	LTV-8175-C	S	173	RRG5797
PC202	LTV-8175-C	S	173	RRG5797
PC203	LTV-8175-C	S	173	RRG5797
PC231	LTV-8175-C	S	173	RRG5797
PC911	LTV-8175-C	S	173	RRG5797
PC912	LTV-8175-C	S	173	RRG5797

RELAY

Part No.	Value	Unit	QTY	Remarks
RL001	4AS-1A-240	RT	41	RRR31778
RL002	5AD-12W	RT	42	RRR31788

RELAY MOTOR

Part No.	Value	Unit	QTY	Remarks
RM001	30A-BRLCS-1	M	31	RRR51099
RM002	30A-BRLCS-1	M	31	RRR51099
RM003	30A-BRLCS-1	M	31	RRR51099
RM004	30A-BRLCS-1	M	31	RRR51099
RM005	30A-BRLCS-1	M	31	RRR51099
RM006	30A-BRLCS-1	M	31	RRR51099
RM007	30A-BRLCS-1	M	31	RRR51099
RM008	30A-BRLCS-1	M	31	RRR51099
RM009	30A-BRLCS-1	M	31	RRR51099
RM010	30A-BRLCS-1	M	31	RRR51099
RM011	30A-BRLCS-1	M	31	RRR51099
RM012	30A-BRLCS-1	M	31	RRR51099
RM013	30A-BRLCS-1	M	31	RRR51099
RM014	30A-BRLCS-1	M	31	RRR51099
RM015	30A-BRLCS-1	M	31	RRR51099
RM016	30A-BRLCS-1	M	31	RRR51099
RM017	30A-BRLCS-1	M	31	RRR51099
RM018	30A-BRLCS-1	M	31	RRR51099
RM019	30A-BRLCS-1	M	31	RRR51099
RM020	30A-BRLCS-1	M	31	RRR51099
RM021	30A-BRLCS-1	M	31	RRR51099
RM022	30A-BRLCS-1	M	31	RRR51099
RM023	30A-BRLCS-1	M	31	RRR51099
RM024	30A-BRLCS-1	M	31	RRR51099
RM025	30A-BRLCS-1	M	31	RRR51099
RM026	30A-BRLCS-1	M	31	RRR51099
RM027	30A-BRLCS-1	M	31	RRR51099
RM028	30A-BRLCS-1	M	31	RRR51099
RM029	30A-BRLCS-1	M	31	RRR51099
RM030	30A-BRLCS-1	M	31	RRR51099

DIODE

Part No.	Value	Unit	QTY	Remarks
D001	1N4148	D	1	RRR51099
D002	1N4148	D	1	RRR51099
D003	1N4148	D	1	RRR51099
D004	1N4148	D	1	RRR51099
D005	1N4148	D	1	RRR51099
D006	1N4148	D	1	RRR51099
D007	1N4148	D	1	RRR51099
D008	1N4148	D	1	RRR51099
D009	1N4148	D	1	RRR51099
D010	1N4148	D	1	RRR51099
D011	1N4148	D	1	RRR51099
D012	1N4148	D	1	RRR51099
D013	1N4148	D	1	RRR51099
D014	1N4148	D	1	RRR51099
D015	1N4148	D	1	RRR51099
D016	1N4148	D	1	RRR51099
D017	1N4148	D	1	RRR51099
D018	1N4148	D	1	RRR51099
D019	1N4148	D	1	RRR51099
D020	1N4148	D	1	RRR51099
D021	1N4148	D	1	RRR51099
D022	1N4148	D	1	RRR51099
D023	1N4148	D	1	RRR51099
D024	1N4148	D	1	RRR51099
D025	1N4148	D	1	RRR51099
D026	1N4148	D	1	RRR51099
D027	1N4148	D	1	RRR51099
D028	1N4148	D	1	RRR51099
D029	1N4148	D	1	RRR51099
D030	1N4148	D		

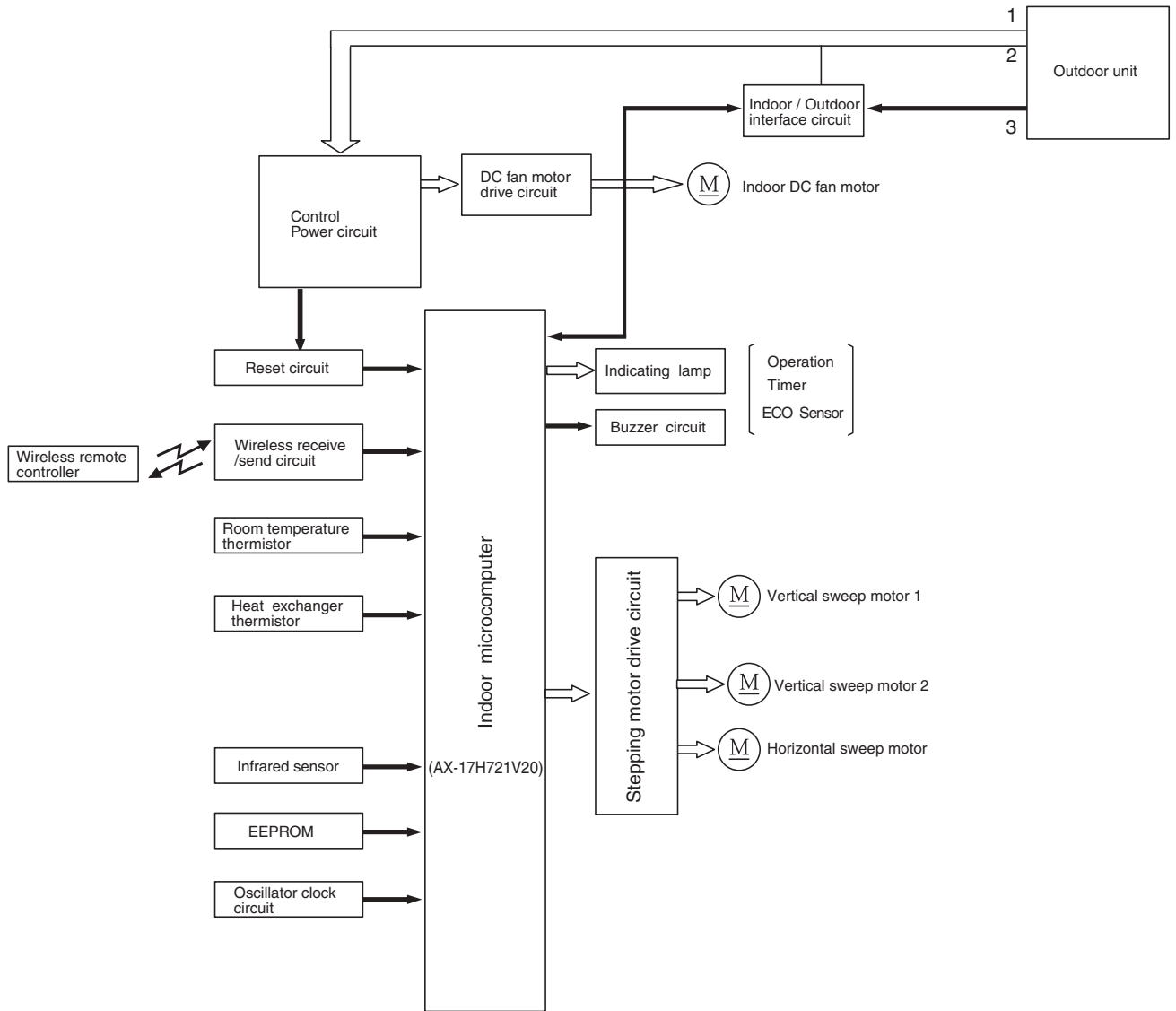




# BLOCK DIAGRAM

MODEL RAK-18QXD, RAK-25RXD, RAK-35RXD, RAK-50RXD

INDOOR UNIT



# BASIC MODE

MODEL RAK-18QXD, RAK-25RXD, RAK-35RXD, RAK-50RXD

Operation mode	Fan	Cooling	Dehumidifying	Heating	Auto	
Basic operation of start/stop button						
Timer functions	Off-timer					
	On-timer					
	Off -> On On -> Off timer					
Fan speed mode (indoor fan)	Auto	<p>Changes from "Hi" to "Med" or "Lo" depending on room temperature.</p> <ol style="list-style-type: none"> <li>Runs at "Hi" until room temperature reaches to "setting temperature-SFTDSC" after operation is started.</li> <li>Runs at "ultra-Lo" when thermo is off.</li> </ol>		<p>Set to "ultra-Lo", "Silent", "Lo", "Med", "Hi", "ultra-Hi" or "stop" depending on the room temperature, time and heat exchanger temperature. Set to "stop" if the heat exchanger temperature is "DNZKOF" during Thermo OFF. (When reach at "DNZKON", fan speed set to "ultra-Lo" again.)</p> <p>In modes other than left</p>	<p>Operating mode is judged by room temperature.</p> <p>(1) Judging by room temperature</p> <ul style="list-style-type: none"> <li>Operating mode at start up is judged (initial judgment).</li> <li>(a) Conditions for judgment (any of the followings). <ul style="list-style-type: none"> <li>When auto operation is started after the previous auto mode operation.</li> <li>When auto operation is started after the previous manual mode operation.</li> <li>When the operating mode is switched to auto while operating at manual mode.</li> </ul> </li> <li>(b) Judging method <ul style="list-style-type: none"> <li>[ Cooling ] : Room temperature <math>\geq</math> Remote controller setting</li> <li>[ Heating ] : Room temperature <math>&lt;</math> Remote controller setting</li> </ul> </li> </ul>	
	Hi	Operates at "Hi" regardless of the room temperature.	Set to "ultra-Hi" when the compressor runs at cold dash mode speed, and to "Hi" in other modes. Runs at "ultra-Lo" when thermo is off.		Set to "ultra-Lo", "Silent", "Lo", "Med", "Hi", "ultra-Hi" or "stop" depending on the room temperature, time and heat exchanger temperature. Set to "stop" if the heat exchanger temperature is "DNZKOF" during Thermo OFF. (When reach at "DNZKON", fan speed set to "ultra-Lo" again.) Set to "ultra-Hi" when the compressor is running at maximum speed during hot dash or when recovered from defrosting.	
	Med	Operates at "Med" regardless of the room temperature.	Operates at "Med" regardless of the room temperature. Runs at "ultra-Lo" when thermo is off.		Set to "ultra-Lo", "Silent", "Lo", "Med", "Hi", "ultra-Hi" or "stop" depending on the room temperature, time and heat exchanger temperature. Set to "stop" if the heat exchanger temperature is "DNZKOF" during Thermo OFF. (When reach at "DNZKON", fan speed set to "ultra-Lo" again.)	
	Lo	Operates at "Lo" regardless of the room temperature.	Operates at "Lo" regardless of the room temperature. Runs at "ultra-Lo" when thermo is off.	Set to "Lo" in modes other than when the compressor stops.	Set to "ultra-Lo", "Silent", "Lo", "Med", "Hi", "ultra-Hi" or "stop" depending on the room temperature, time and heat exchanger temperature. Set to "stop" if the heat exchanger temperature is "DNZKOF" during Thermo OFF. (When reach at "DNZKON", fan speed set to "ultra-Lo" again.) The fan speed is controlled by the heat exchanger temperature; the overload control is executed as in the following diagram:	
	Silent	Operates at "Silent" regardless of the room temperature.	Operates at "Silent" regardless of the room temperature. Runs at "ultra-Lo" when thermo is off.	Set to "Silent" in modes other than when the compressor stops.		
Basic operation of temperature controller	Performs only fan operation at the set speed regardless of the room temperature.	See page 39.	See page 41.	See page 43.		
Sleep operation (with sleep button ON)	<ul style="list-style-type: none"> <li>Enters sleep operation after set as on the left.</li> <li>Action during sleep operation Lo (sleep) operation</li> </ul>	<ul style="list-style-type: none"> <li>Same as at left</li> <li>See page 40.</li> </ul>	<ul style="list-style-type: none"> <li>Same as at left</li> <li>See page 42.</li> </ul>	<ul style="list-style-type: none"> <li>Same as at left</li> <li>See page 44.</li> </ul>	<ul style="list-style-type: none"> <li>Same as at left.</li> <li>Performs the sleep operation of each operation mode.</li> </ul>	



For the multi indoor unit

MODEL		RAK-18QXD (1.8KW)	RAK-15QXD (1.2KW)	RAK-25RXD	RAK-35RXD	RAK-50RXD
PROM NO.	LABEL NAME	REQUIRED VALUE OF UNIT	REQUIRED VALUE OF UNIT	REQUIRED VALUE OF UNIT	REQUIRED VALUE OF UNIT	REQUIRED VALUE OF UNIT
51A	WMAX_M	4900 min <sup>-1</sup>	4900 min <sup>-1</sup>	4900 min <sup>-1</sup>	4900 min <sup>-1</sup>	4900 min <sup>-1</sup>
51B	WMAX2_M	4900 min <sup>-1</sup>	4900 min <sup>-1</sup>	4900 min <sup>-1</sup>	4900 min <sup>-1</sup>	4900 min <sup>-1</sup>
51D	WSTD_M	3500 min <sup>-1</sup>	3500 min <sup>-1</sup>	3500 min <sup>-1</sup>	3500 min <sup>-1</sup>	3500 min <sup>-1</sup>
523	CMAX_M	4200 min <sup>-1</sup>	4200 min <sup>-1</sup>	4200 min <sup>-1</sup>	4200 min <sup>-1</sup>	4200 min <sup>-1</sup>
524	CMAX2_M	4200 min <sup>-1</sup>	4200 min <sup>-1</sup>	4200 min <sup>-1</sup>	4200 min <sup>-1</sup>	4200 min <sup>-1</sup>
527	CSTD_M	3500 min <sup>-1</sup>	3500 min <sup>-1</sup>	3500 min <sup>-1</sup>	3500 min <sup>-1</sup>	3500 min <sup>-1</sup>
531	SDMAX_M	3500 min <sup>-1</sup>	3500 min <sup>-1</sup>	3500 min <sup>-1</sup>	3500 min <sup>-1</sup>	3500 min <sup>-1</sup>
532	SDRPM_M	2200 min <sup>-1</sup>	2200 min <sup>-1</sup>	2200 min <sup>-1</sup>	2200 min <sup>-1</sup>	2200 min <sup>-1</sup>
533	WMINSZ_M	1000 min <sup>-1</sup>	1000 min <sup>-1</sup>	1000 min <sup>-1</sup>	1000 min <sup>-1</sup>	1000 min <sup>-1</sup>
53B	CMINSZ_M	900 min <sup>-1</sup>	900 min <sup>-1</sup>	900 min <sup>-1</sup>	900 min <sup>-1</sup>	900 min <sup>-1</sup>
53C	CMIN_M	900 min <sup>-1</sup>	900 min <sup>-1</sup>	900 min <sup>-1</sup>	900 min <sup>-1</sup>	900 min <sup>-1</sup>
53E	DMIN_M	900 min <sup>-1</sup>	900 min <sup>-1</sup>	900 min <sup>-1</sup>	900 min <sup>-1</sup>	900 min <sup>-1</sup>
53F	PKOU_W_M	400 min <sup>-1</sup>	400 min <sup>-1</sup>	400 min <sup>-1</sup>	400 min <sup>-1</sup>	400 min <sup>-1</sup>
541	FZZY_GN_M	1	1	1	1	1
543	FZZYTM_M	2min	2min	2min	2min	2min
544	DWNRATEW_M	80%	80%	80%	80%	80%
545	DWNRATEC_M	60%	60%	60%	60%	70%
55C	SHIFTW_M	0.00°C	0.00°C	0.00°C	0.00°C	0.00°C
55D	SFTSZW_M	0.00°C	0.00°C	0.00°C	0.00°C	0.00°C
564	SHIFTC_M	0.00°C	0.00°C	0.00°C	0.00°C	0.00°C
568	SHIFTD_M	0.00°C	0.00°C	0.00°C	0.00°C	0.00°C
526	CLMXTP_M	33.00°C	33.00°C	33.00°C	33.00°C	33.00°C
590	YNEOF_M	25.00°C	25.00°C	25.00°C	25.00°C	25.00°C
5BB	SFTDSW_M	1.00°C	1.00°C	1.00°C	0.66°C	0.66°C
57F	TEION_M	2.00°C	2.00°C	2.00°C	2.00°C	2.00°C
580	TEIOF_M	9.00°C	9.00°C	9.00°C	9.00°C	9.00°C
5CC	FWSS_M	350 min <sup>-1</sup>	350 min <sup>-1</sup>	350 min <sup>-1</sup>	350 min <sup>-1</sup>	500 min <sup>-1</sup>
5CD	FWSOY_M	450 min <sup>-1</sup>	450 min <sup>-1</sup>	500 min <sup>-1</sup>	500 min <sup>-1</sup>	500 min <sup>-1</sup>
5CE	FWS_M	540 min <sup>-1</sup>	500 min <sup>-1</sup>	600 min <sup>-1</sup>	630 min <sup>-1</sup>	700 min <sup>-1</sup>
5D0	FWKAF_M	750 min <sup>-1</sup>	650 min <sup>-1</sup>	780 min <sup>-1</sup>	850 min <sup>-1</sup>	900 min <sup>-1</sup>
5D1	FWL_M	850 min <sup>-1</sup>	850 min <sup>-1</sup>	850 min <sup>-1</sup>	880 min <sup>-1</sup>	950 min <sup>-1</sup>
5D2	FWAH_M	870 min <sup>-1</sup>	770 min <sup>-1</sup>	900 min <sup>-1</sup>	1100 min <sup>-1</sup>	1150 min <sup>-1</sup>
5D3	FWH_M	870 min <sup>-1</sup>	770 min <sup>-1</sup>	900 min <sup>-1</sup>	1100 min <sup>-1</sup>	1150 min <sup>-1</sup>
5D5	FWHH_M	930 min <sup>-1</sup>	930 min <sup>-1</sup>	950 min <sup>-1</sup>	1100 min <sup>-1</sup>	1150 min <sup>-1</sup>
5DB	FCSOY_M	450 min <sup>-1</sup>	450 min <sup>-1</sup>	450 min <sup>-1</sup>	500 min <sup>-1</sup>	500 min <sup>-1</sup>
5DC	FCS_M	500 min <sup>-1</sup>	450 min <sup>-1</sup>	500 min <sup>-1</sup>	540 min <sup>-1</sup>	550 min <sup>-1</sup>
5DD	FCL_M	670 min <sup>-1</sup>	570 min <sup>-1</sup>	670 min <sup>-1</sup>	750 min <sup>-1</sup>	800 min <sup>-1</sup>
5DE	FCAH_M	830 min <sup>-1</sup>	700 min <sup>-1</sup>	880 min <sup>-1</sup>	1100 min <sup>-1</sup>	1150 min <sup>-1</sup>
5DF	FCH_M	830 min <sup>-1</sup>	700 min <sup>-1</sup>	880 min <sup>-1</sup>	1100 min <sup>-1</sup>	1150 min <sup>-1</sup>
5E0	FCHH_M	830 min <sup>-1</sup>	770 min <sup>-1</sup>	920 min <sup>-1</sup>	1100 min <sup>-1</sup>	1150 min <sup>-1</sup>
5E2	FDOY_M	450 min <sup>-1</sup>	400 min <sup>-1</sup>	450 min <sup>-1</sup>	500 min <sup>-1</sup>	500 min <sup>-1</sup>
5E3	FDS1_M	500 min <sup>-1</sup>	450 min <sup>-1</sup>	500 min <sup>-1</sup>	540 min <sup>-1</sup>	550 min <sup>-1</sup>
5E4	FDS2_M	500 min <sup>-1</sup>	500 min <sup>-1</sup>	500 min <sup>-1</sup>	540 min <sup>-1</sup>	550 min <sup>-1</sup>

Table 1 Fan speed by mode

Operation mode	Fan speed mode		Label name
	Ultra Lo		
Sleep		FWSOY_M	
Heating operation	Lo		FWS_M
	Overload		FWKAF_M
	Med		FWL_M
	Hi	Set fan speed "AUTO"	FWAH_M
	Hi	Set fan speed "Hi"	FWH_M
	Ultra Hi		FWHH_M
	Sleep		FCSOY_M
	Lo		FCS_M
Cooling operation	Med		FCL_M
	Hi	Set fan speed "AUTO"	FCAH_M
	Hi	Set fan speed "Hi"	FCH_M
	Ultra Hi		FCHH_M
	Sleep		FDOY_M
Dehumidifying operation	Lo 1		FDS1_M
	Lo 2		FDS2_M

Table 2 Room temperature shift value

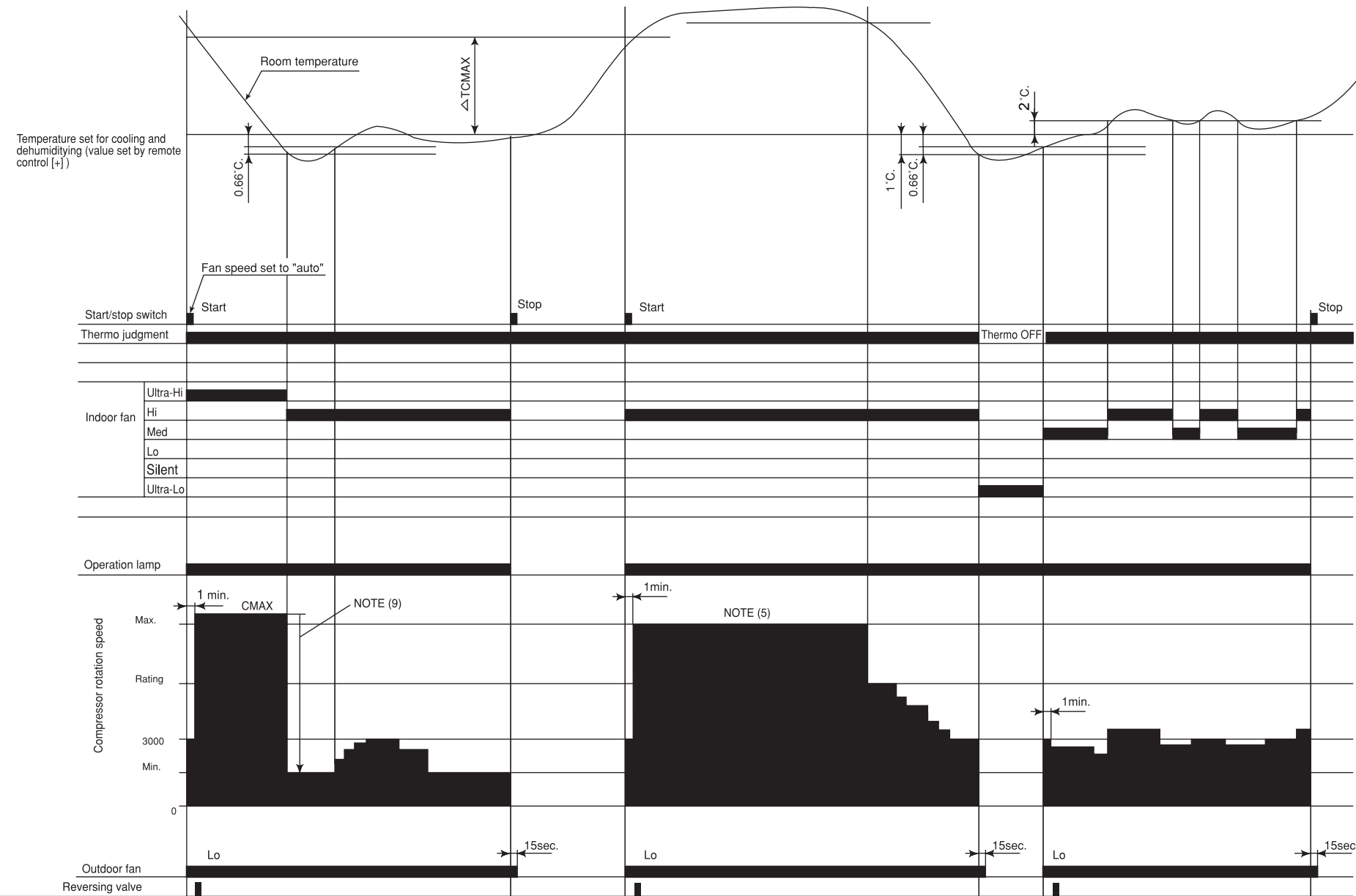
Operation mode		Shift value
Heating operation	Fan speed "AUTO, Hi, Med"	SHIFTW_M
	Fan speed "Lo, Sleep"	SFTSZW_M
Cooling operation		SHIFTC_M
Dehumidifying operation		SHIFTD_M

For the single indoor unit

**Table 1 Mode data file**

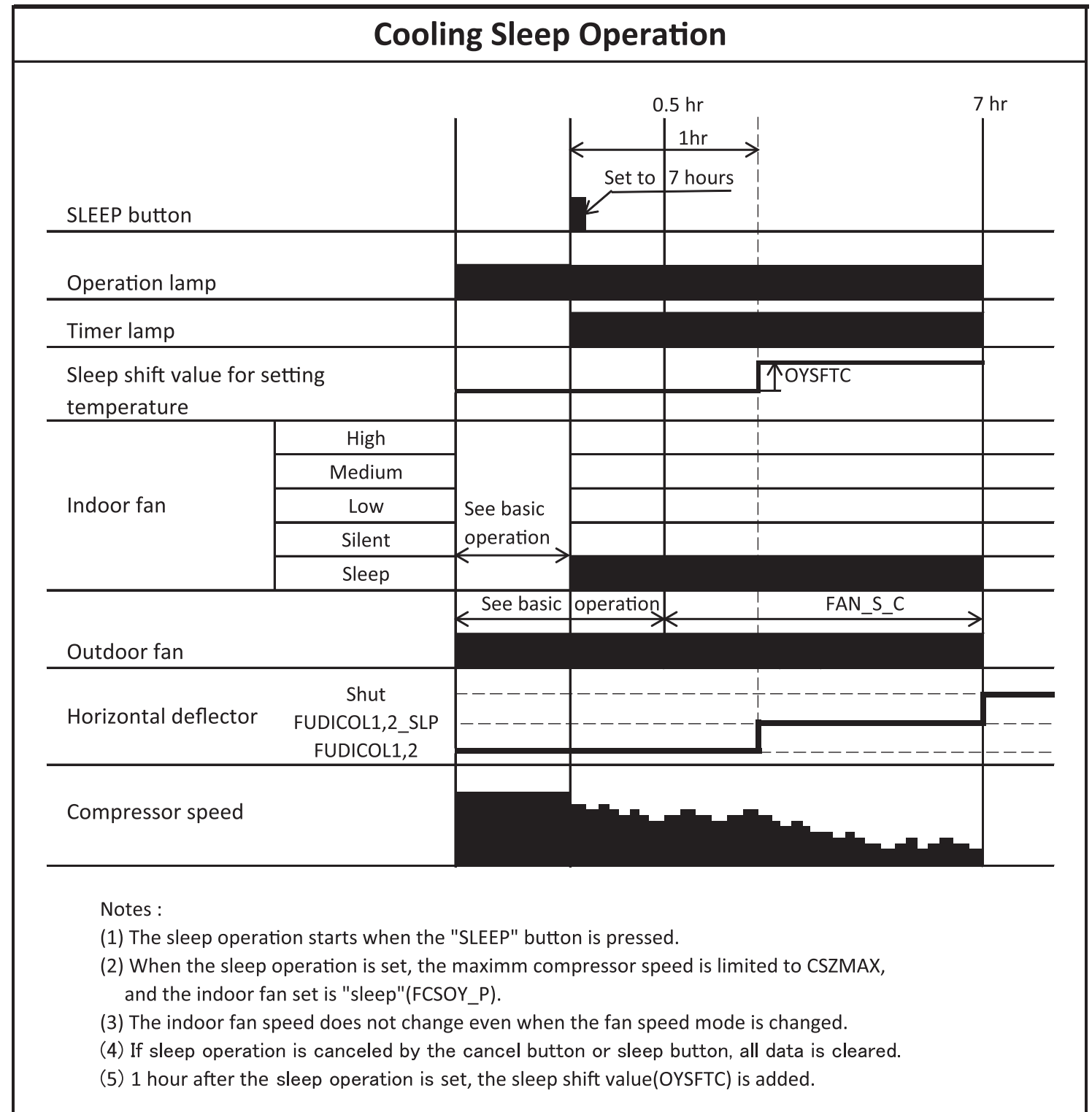
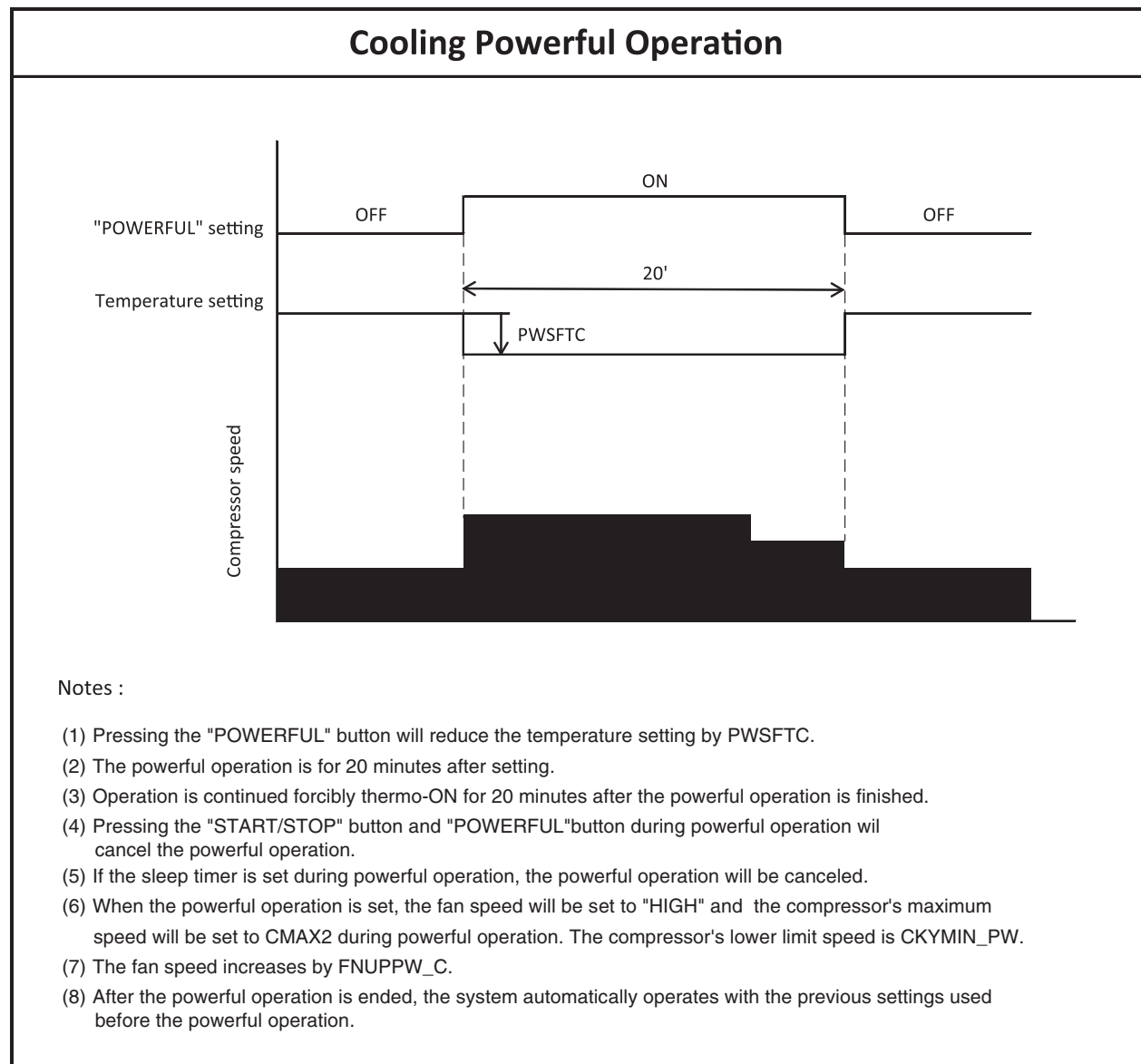
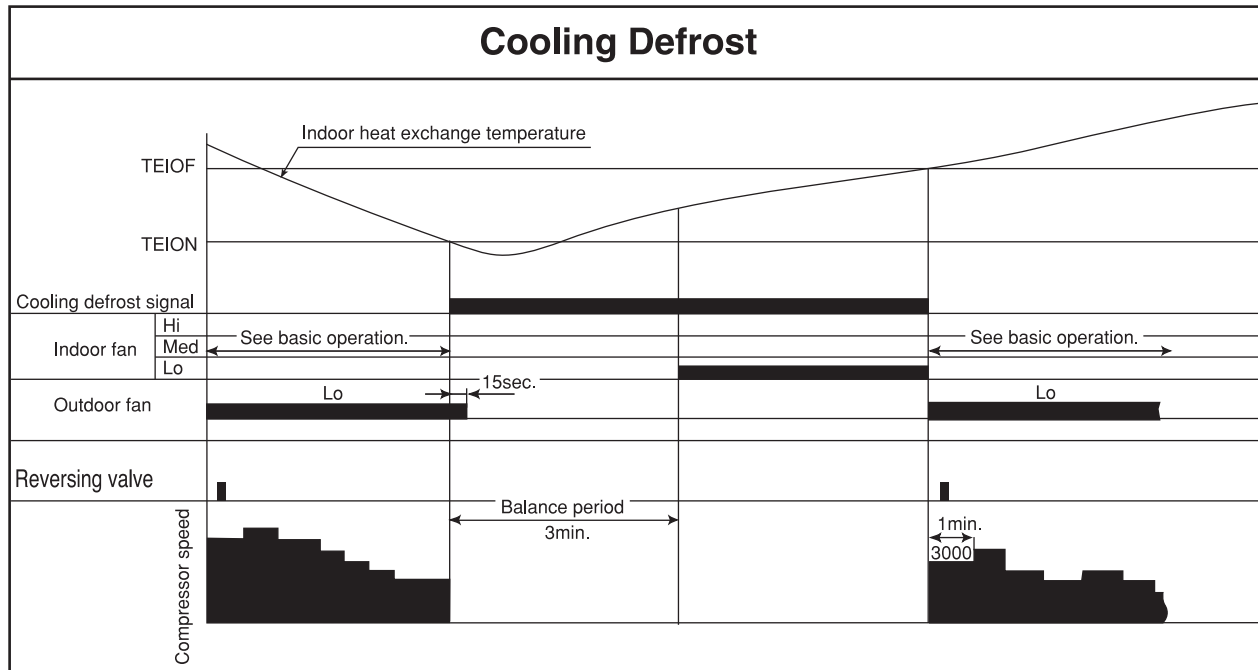
MODEL	RAK-25RXD	RAK-35RXD	RAK-50RXD
LABEL NAME	VALUE		
WMAX	4400 min <sup>-1</sup>	5300 min <sup>-1</sup>	5400 min <sup>-1</sup>
WMAX2	5800 min <sup>-1</sup>	6500 min <sup>-1</sup>	6600 min <sup>-1</sup>
WSTD	3100 min <sup>-1</sup>	3900 min <sup>-1</sup>	4000 min <sup>-1</sup>
WJKMAX	2900 min <sup>-1</sup>	3600 min <sup>-1</sup>	3600 min <sup>-1</sup>
WBEMAX	2700 min <sup>-1</sup>	3200 min <sup>-1</sup>	3300 min <sup>-1</sup>
WSZMAX	2600 min <sup>-1</sup>	3000 min <sup>-1</sup>	2900 min <sup>-1</sup>
CMAX	3150 min <sup>-1</sup>	4600 min <sup>-1</sup>	4800 min <sup>-1</sup>
CMAX2	3150 min <sup>-1</sup>	4600 min <sup>-1</sup>	4800 min <sup>-1</sup>
CSTD	2300 min <sup>-1</sup>	3600 min <sup>-1</sup>	3850 min <sup>-1</sup>
CJKMAX	2200 min <sup>-1</sup>	3200 min <sup>-1</sup>	3600 min <sup>-1</sup>
CBEMAX	2100 min <sup>-1</sup>	2800 min <sup>-1</sup>	2000 min <sup>-1</sup>
CSZMAX	2000 min <sup>-1</sup>	2200 min <sup>-1</sup>	2200 min <sup>-1</sup>
WIN-CMPH	2400 min <sup>-1</sup>	2400 min <sup>-1</sup>	2400 min <sup>-1</sup>
WIN-CMPL	2400 min <sup>-1</sup>	2400 min <sup>-1</sup>	2400 min <sup>-1</sup>
CMIN	1800 min <sup>-1</sup>	1800 min <sup>-1</sup>	1700 min <sup>-1</sup>
STARTMC	90 Seconds	90 Seconds	90 Seconds
DWNRATEW	80%	80%	80%
DWNRATEC	60%	60%	80%
SHIFTW	0.00°C	0.00°C	3.00°C
SHIFTC	0.00°C	0.00°C	0.00°C
CLMXTTP	30.00°C	30.00°C	30.00°C
TEION	2.00°C	2.00°C	2.00°C
TEIOF	6.00°C	6.00°C	6.00°C
SFTDSW	0.66°C	0.66°C	0.66°C
DFTIM-OTPO	43 Minutes	40 Minutes	45 Minutes
DFTIM-OTP5	43 Minutes	55 Minutes	60 Minutes
DFTIM-OTP10	43 Minutes	55 Minutes	60 Minutes
FCAUT-L	0.66°C	0.66°C	0.66°C
FCAUT-H	2.00°C	2.00°C	2.00°C
SFTDSC	0.66°C	0.66°C	0.66°C
OFTMPC	1.00°C	1.00°C	1.00°C
DASUPHH	45.00°C	45.00°C	39.00°C
DASDNHH	41.00°C	41.00°C	36.00°C
DASUPH	40.00°C	40.00°C	35.00°C
DASDNH	35.33°C	35.33°C	32.00°C
DASUPL	35.00°C	35.00°C	31.00°C
DASDNL	28.00°C	28.00°C	29.00°C
DASUPS	28.00°C	28.00°C	28.00°C
DASDNS	27.00°C	27.00°C	26.00°C
NORUPH	45.00°C	45.00°C	45.00°C
NORDNH	40.00°C	40.00°C	39.00°C
NORUPL	37.00°C	37.00°C	37.00°C
NORDNL	33.00°C	33.00°C	33.66°C
NORUPS	33.00°C	33.00°C	33.00°C
NORDNS	30.00°C	30.00°C	30.00°C
PDCIN2	50.00°C	54.00°C	50.00°C
PDCOF2	45.00°C	48.00°C	48.00°C
DNZKON	15.00°C	15.00°C	15.00°C
DNZKOF	13.00°C	13.00°C	13.00°C
FNUPPW-C	30 min <sup>-1</sup>	30 min <sup>-1</sup>	30 min <sup>-1</sup>
DFMAX-STD	4400 min <sup>-1</sup>	5500 min <sup>-1</sup>	5400 min <sup>-1</sup>
DFMAX-ATF	4400 min <sup>-1</sup>	5500 min <sup>-1</sup>	5400 min <sup>-1</sup>

## Basic Cooling Operation

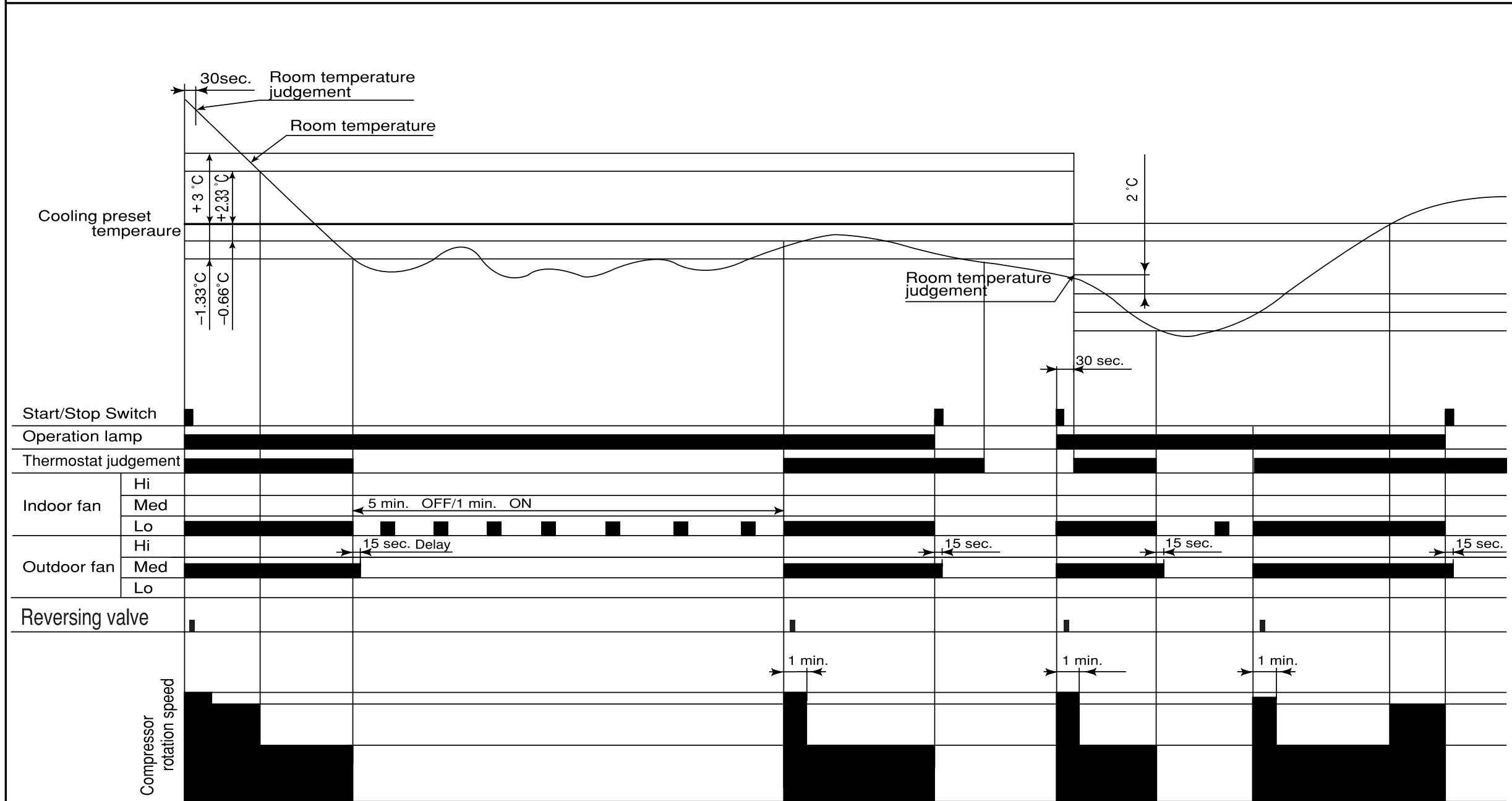


### Notes:

- (1) Condition for entering into Cool Dashed mode. When fan set to "Hi" or "Auto and when the compressor speed (P section) due to temperature difference between setting temperature (including the correction shift only) and room temperature is C<sub>MAX</sub> or higher.
- (2) Cool Dashed will release when i) a maximum 25 minutes is lapsed and ii) room temperature is lower than set temperature  $-3^{\circ}\text{C}$  (thermo off) and iii) when room temperature has achieved setting temperature  $-1^{\circ}\text{C}$  then maximum Cool Dashed time will be revised to 20 minutes. And iv) indoor fan is set to Lo and Med fan mode and v) change operation mode.
- (3) During Cool Dashed operation, thermo off temperature is set temperature (with shift value)  $-3^{\circ}\text{C}$ . After thermo off, operation continue in Fuzzy control mode.
- (4) Compressor minimum "ON" time and "OFF" time is 3 minutes.
- (5) During normal cooling mode, compressor maximum rpm C<sub>MAX</sub> will maintain for 60 minutes if indoor temperature is lower than CLM<sub>XTP</sub>. No time constrain if indoor temperature is higher than CLM<sub>XTP</sub>.
- (6) When fan is set to "Hi", compressor rpm will be limited to C<sub>STD</sub>.
- (7) When fan is set to "Med", compressor rpm will be limited to C<sub>JKMAX</sub>.
- (8) When fan is set to "Lo", compressor rpm will be limited to C<sub>BEMAX</sub>.
- (9) During Cool Dashed, when room temperature reaches set temperature  $-1^{\circ}\text{C}$  compressor rpm is actual rpm x D<sub>WNRATEC</sub>.



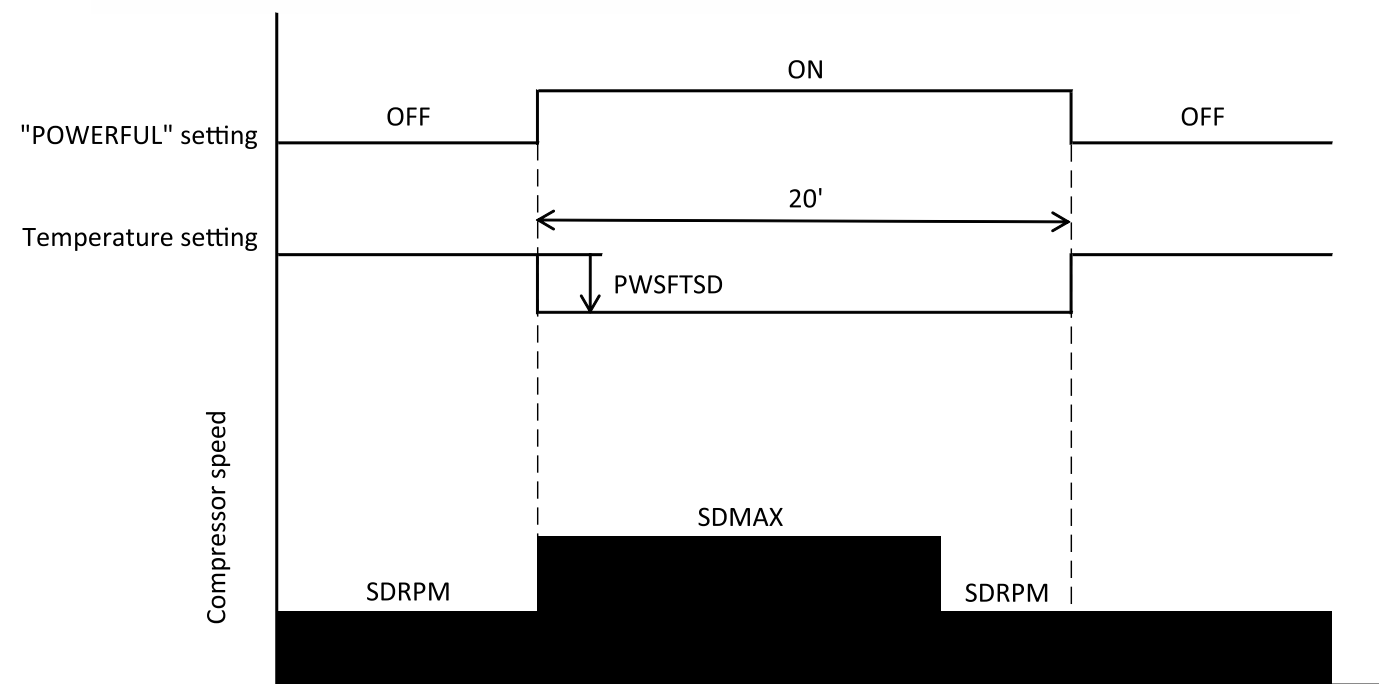
# Dehumidifying



**Notes:**

- (1) If the room temperature is (cooling preset temperature) - (1.33°C) or less after 30 seconds from starting the operation, the operation is done assuming as the preset temperature = (room temperature at the time) - (2°C).
- (2) The indoor fan is operated in the "Lo" mode. During thermo OFF indoor fan will be OFF for 5 minutes and ON for 1 minute.
- (3) When the operation is started by the thermostat turning ON, the start of the indoor fan is delayed 32 seconds after the start of compressor operation.
- (4) The compressor is operated forcedly for 3 minutes after operation is started.
- (5) The minimum ON time and OFF time of the compressor are 3 minutes.

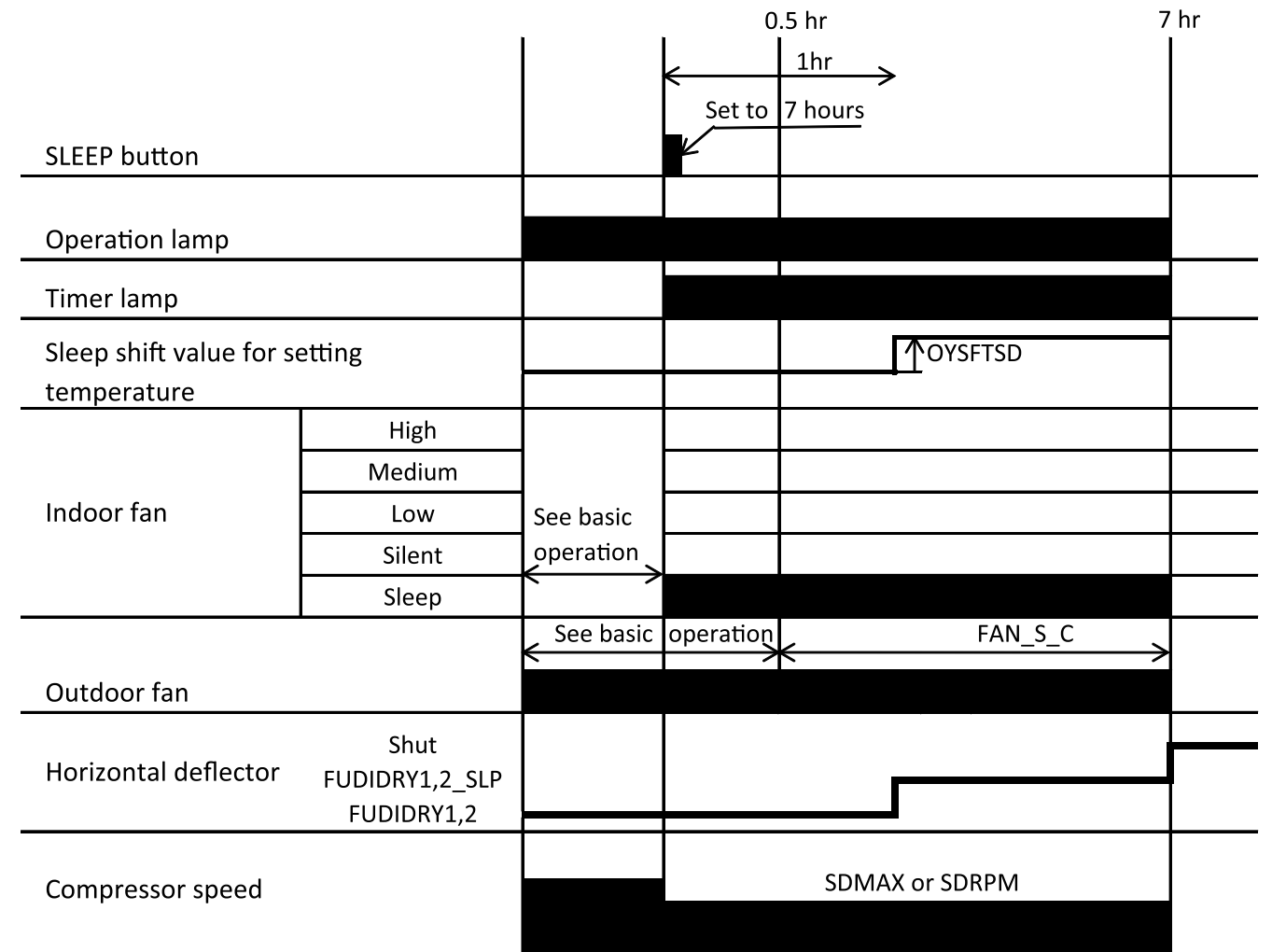
## Dehumidifying Powerful Operation



### Notes :

- (1) Pressing the "POWERFUL" button will reduce the temperature setting by PWSFTSD.
- (2) The powerful operation is for 20 minutes after setting.
- (3) Operation is continued forcibly thermo-ON for 20 minutes after the powerful operation is finished.
- (4) Pressing the "START/STOP" button and "POWERFUL" button during powerful operation will cancel the powerful operation.
- (5) If the sleep timer is set during powerful operation, the powerful operation will be canceled.
- (6) If the differential (the room temperature - the temperature setting) is "the differential  $\geq 3$  °C" after powerful setting, the compressor's maximum speed during powerful operation will be set to SDMAX. Then the differential reduce "the differential  $\geq 2.33$  °C" during powerful operation, the compressor's speed will be set to SDRPM.  
If the differential (the room temperature - the temperature setting) is "the differential  $< 3$  °C" after powerful setting, the compressor's minimum speed during powerful operation will be set to SDRPM.
- (7) After the powerful operation is ended, the system automatically operates with the previous settings used before the powerful operation.

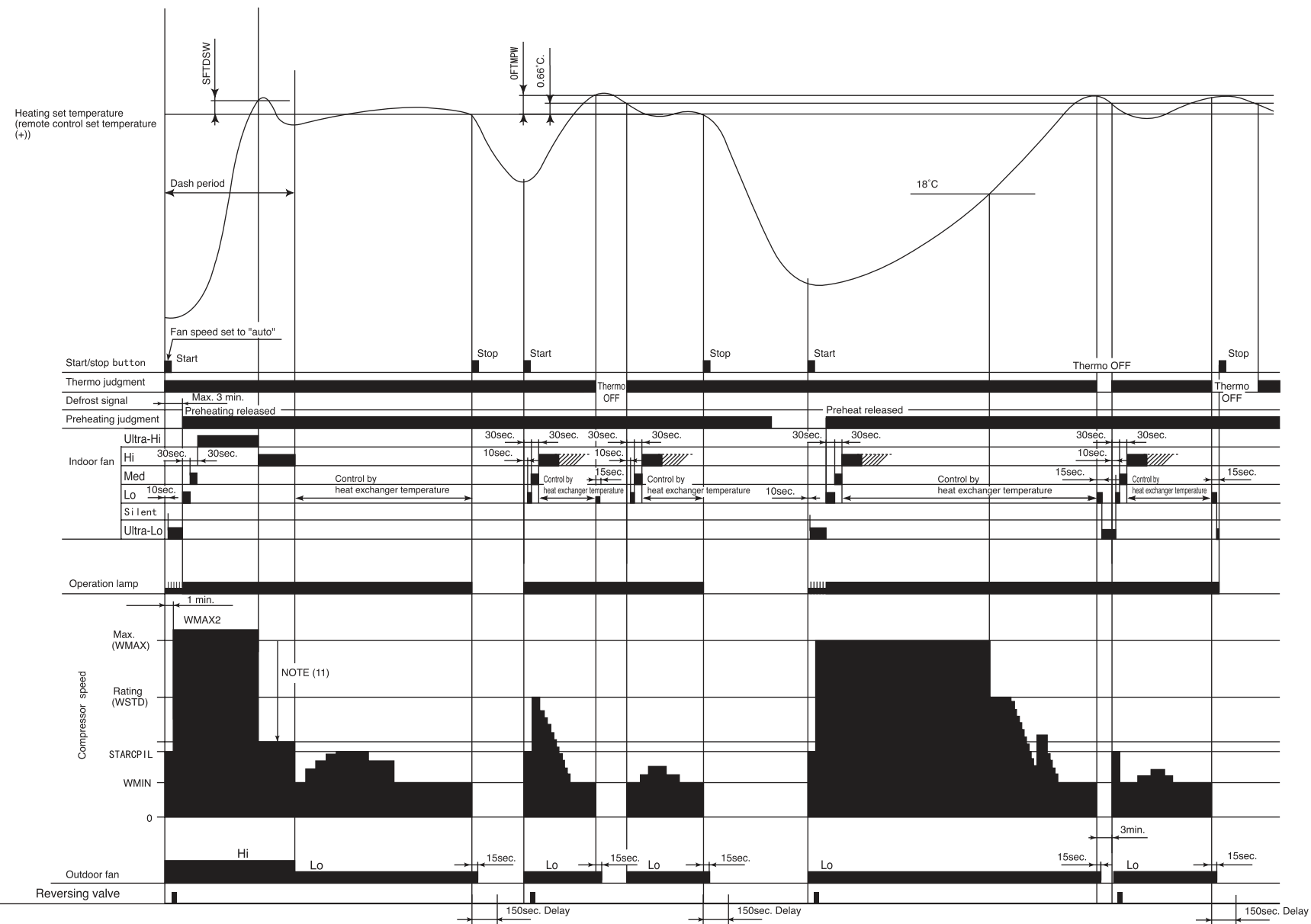
## Dehumidifying Sleep Operation



### Notes :

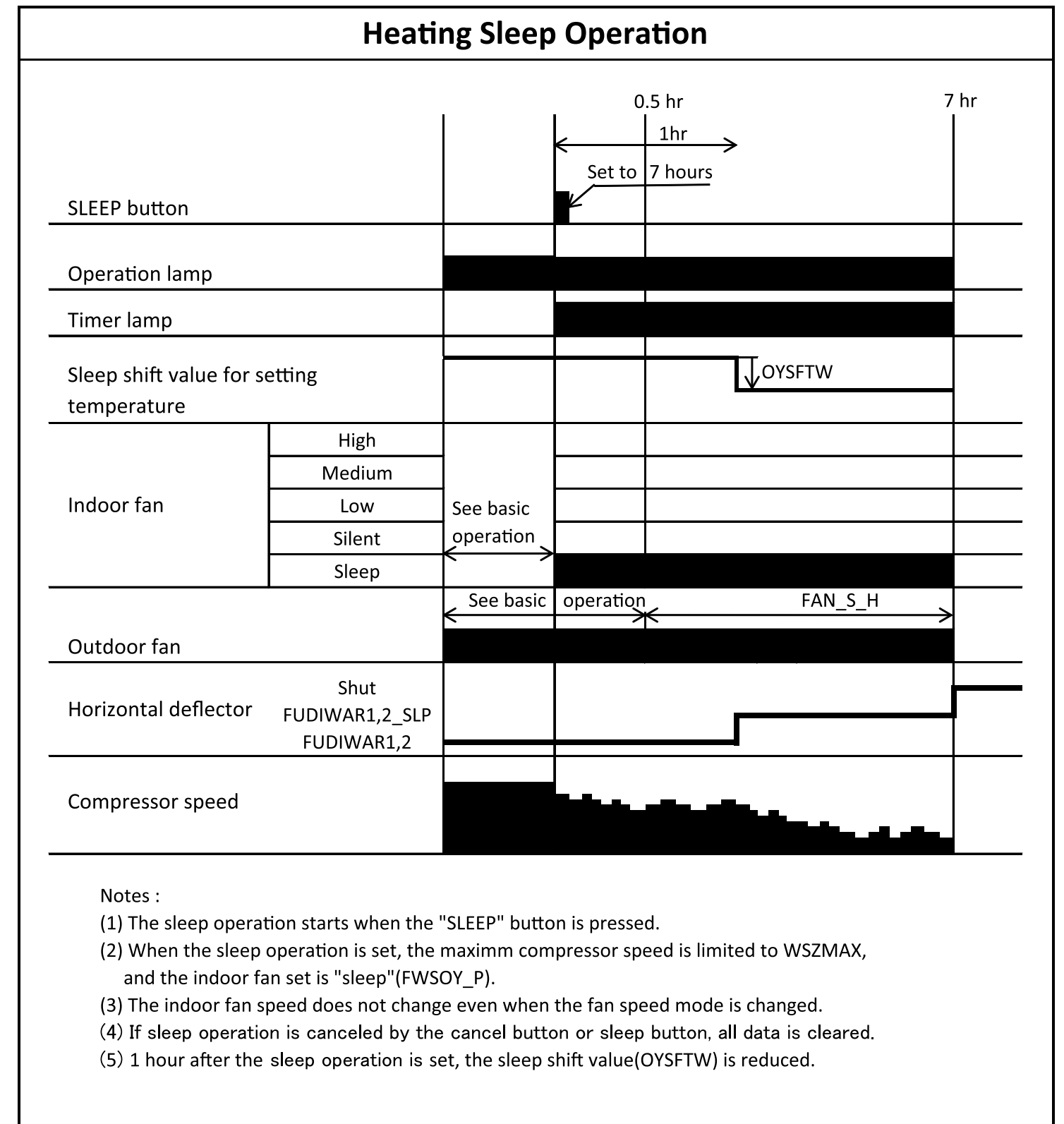
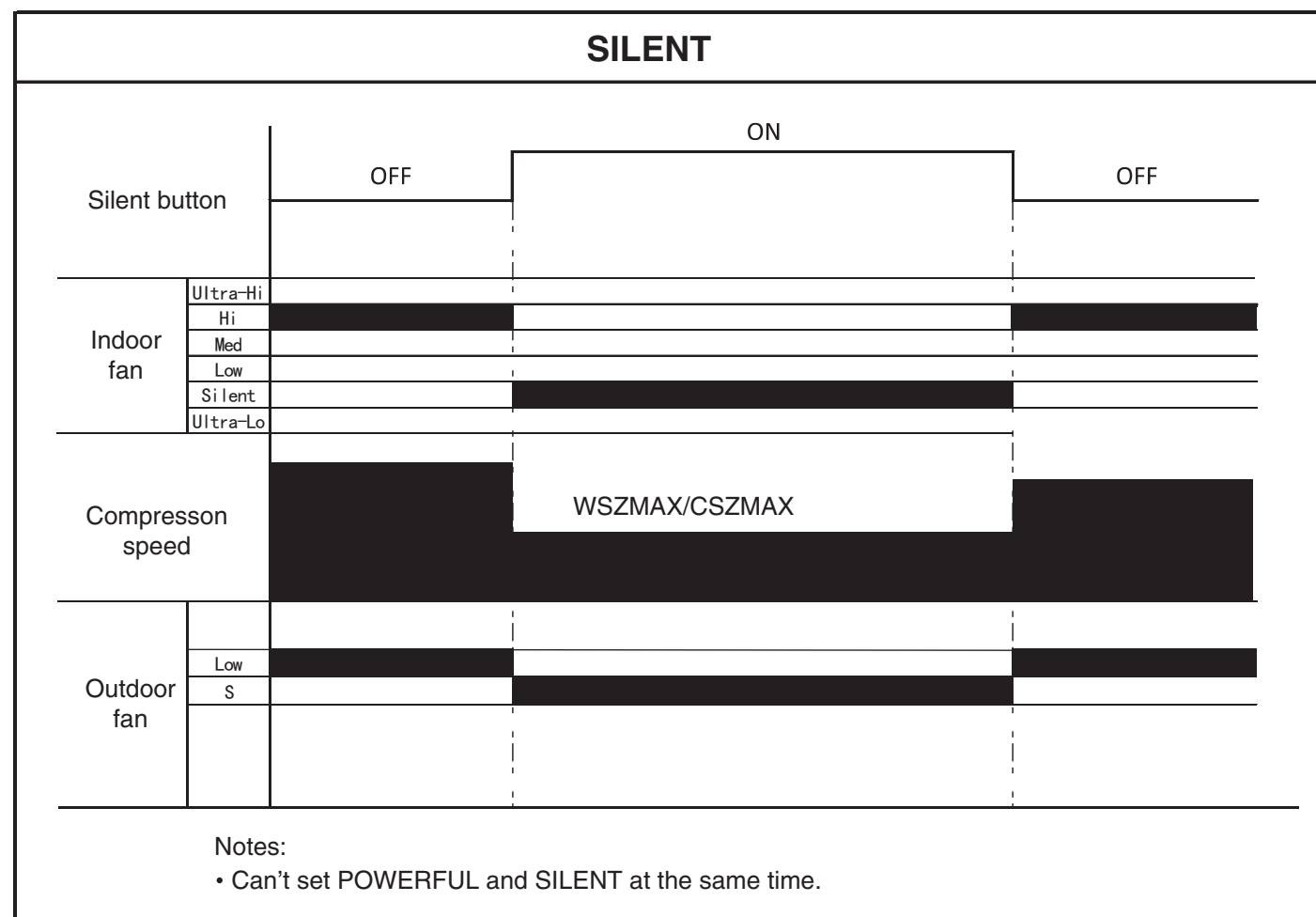
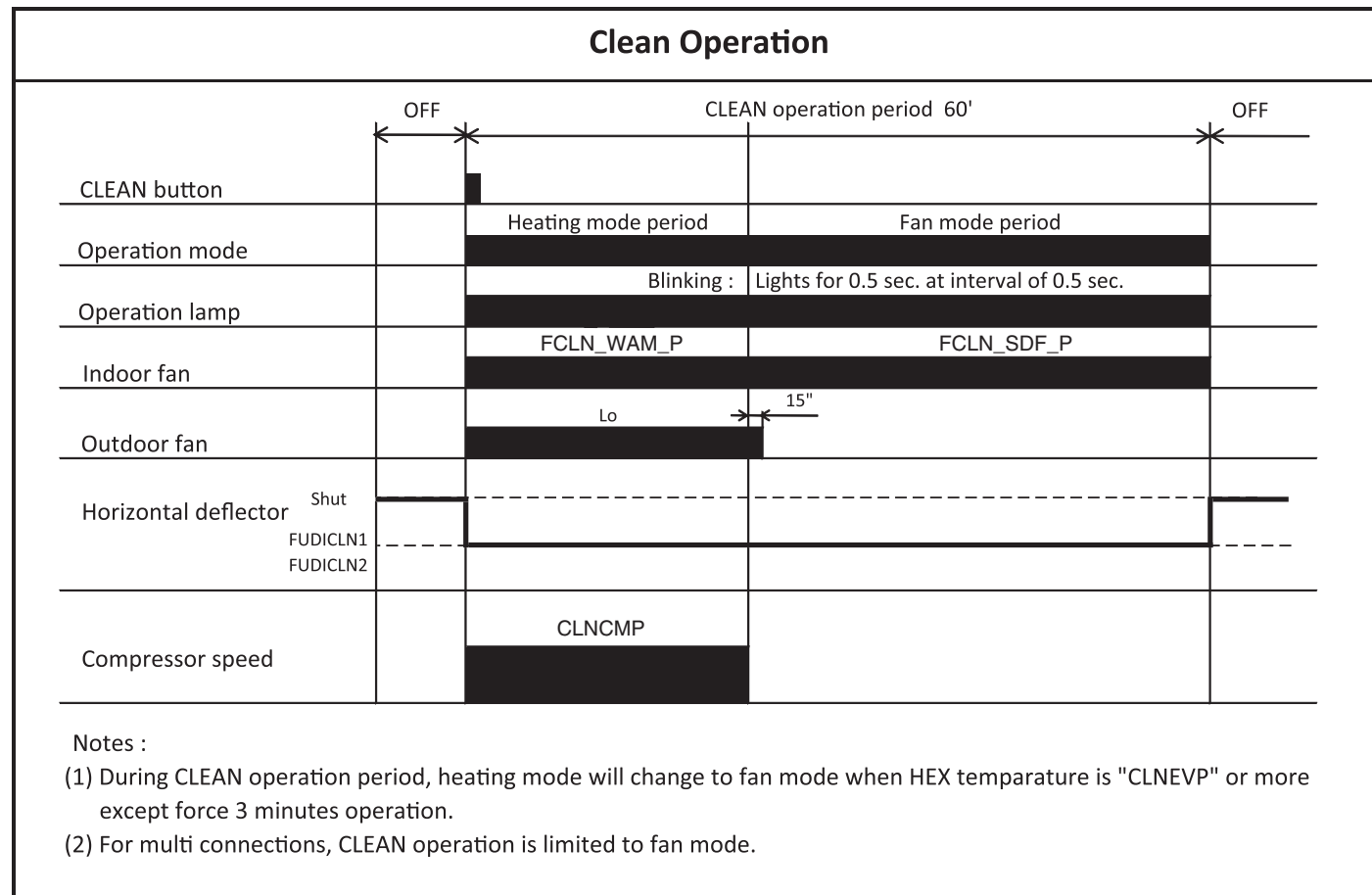
- (1) The sleep operation starts when the "SLEEP" button is pressed.
- (2) When the sleep operation is set, the indoor fan set is "sleep"(FDOY\_P).
- (3) The indoor fan speed does not change even when the fan speed mode is changed.
- (4) If sleep operation is canceled by the cancel button or sleep button, all data is cleared.
- (5) 1 hour after the sleep operation is set, the sleep shift value(OYSFTSD) is added.

## Basic Heating Operation



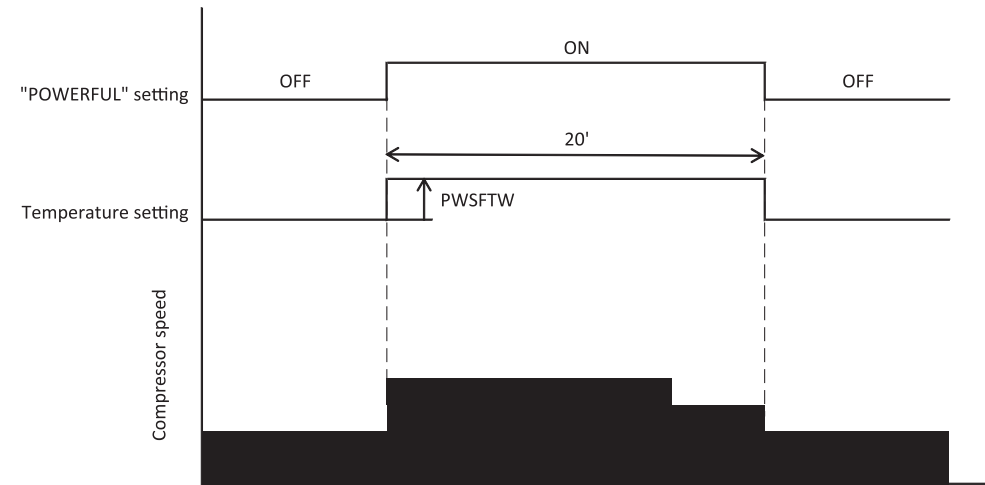
### Notes:

- (1) Condition for entering into hot dashed mode. When fan set to "Hi" or "Auto" and i) room temperature is 18 or less, and ii) outdoor temperature is 10 or less, and iii) compressor speed (P section) due to temperature difference between setting temperature(including shift value only) and room temperature is WMAX or more.
- (2) The maximum compressor speed period during hot dash is finished when i) room temperature has reached the setting temperature + SFTDSW. ii) thermo off.
- (3) During hot dashed operation, thermo off temperature is setting temperature (with shift value) +3. After thermo off, operation continue inn Fuzzy control mode.
- (4) Minimum "ON" time and minimum "OFF" time of compressor operation is 3 minutes.
- (5) During normal heating mode, compressor maximum rpm WMAX will maintain for 120 minutes. No time limit constrain if room temperature is 18 or less and outdoor temperature is 2 or less.
- (6) During preheating or defrosting or auto fresh defrosting mode, indoor unit operation lamp will blink.
- (7) When heating mode starts, it will enter into preheating mode if indoor heat exchanger temperature is less than YNEOF + 0.33.
- (8) When fan is set to "Med" or "Lo" or "Silent", compressor rpm will be limited to "WJKMAX" or "WBEMAX" or "WSZMAX".
- (9) During "Ultra-Lo" mode, if room temperature is 18 or less, indoor fan will stop. If room temperature is 18 + 0.33 or more, fan will continue in "Ultra-Lo" mode. However, "Ultra-Lo" mode during preheating or preheating after defrosting does not stop if room temperature is 18 or less.
- (10) During hot dashed or outdoor temperature is -5 or less, compressor rpm is WMAX2.
- (11) During hot dashed, when room temperature reaches setting temperature + SFTDSW compressor rpm is actual rpm x DWNRATEW.





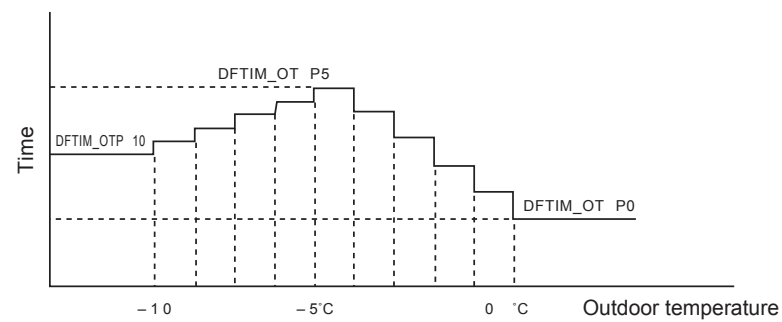
## Heating Powerful Operation



### Notes :

- (1) Pressing the "POWERFUL" button will increase the temperature setting by PWSFTW.
- (2) The powerful operation is for 20 minutes after setting.
- (3) Operation is continued forcibly thermo-ON for 20 minutes after the powerful operation is finished.
- (4) Defrost is inhibited for 20 minutes after the start of the powerful operation.
- (5) Pressing the "START/STOP" button and "POWERFUL" button during powerful operation will cancel the powerful operation.
- (6) If the sleep timer is set during powerful operation, the powerful operation will be canceled.
- (7) When the powerful operation is set, the fan speed will be set to "HIGH" and the compressor's maximum speed will be set to WMAX2 during powerful operation. The compressor's lower limit speed is WKYMIN\_PW.
- (8) After the powerful operation is ended, the system automatically operates with the previous settings used before the powerful operation.

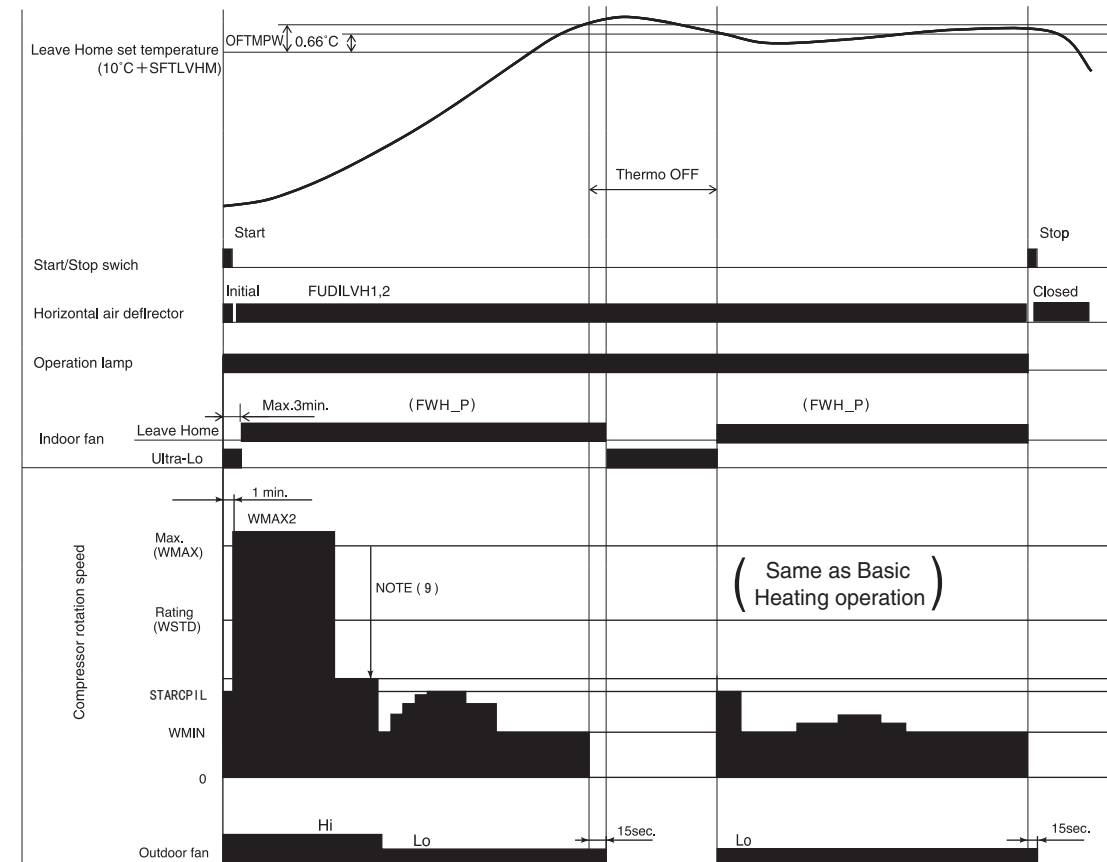
## Setting Defrosting Inhibit Period



### Notes:

- (1) The first inhibit time after operation start is set to DFTIM\_FST.
- (2) From the second time onwards, the inhibit time is set according to the time required for defrosting.  
Reverse cycle operation time  $\geq$  [DEFCOL] : DEFTIM\_COL is set.  
Reverse cycle operation time  $<$  [DEFCOL] : The time corresponding to outdoor temperature is set.

## Leave Home

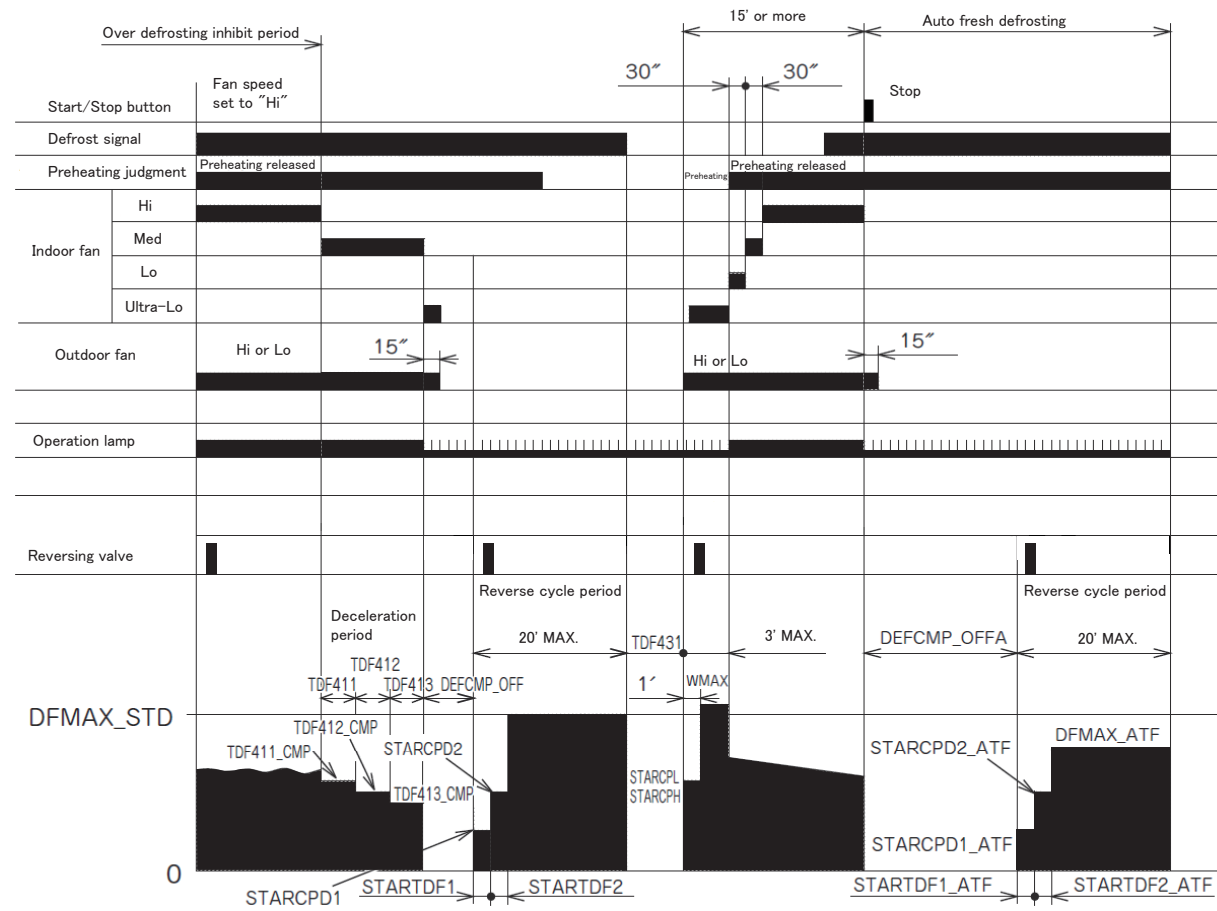


### Notes:

Perform Leave Home operation according to the following control contents.

- (1) Operation mode : Heating
- (2) Temperature set : 10°C ~ 16°C
- (3) Temperature setting correction shift : + 『SFTLVHM』
- (4) Indoor fan : 『FWH\_P』
- (5) Outdoor fan speed :
- (6) Compressor start control : } Same as Basic Heating operation
- (7) Compressor speed : }
- (8) Lamp indication : i) Operation lamp : ON  
ii) Timer lamp : OFF( Continuous operation ) ; ON( Day timer operation )

# Reversing valve defrosting

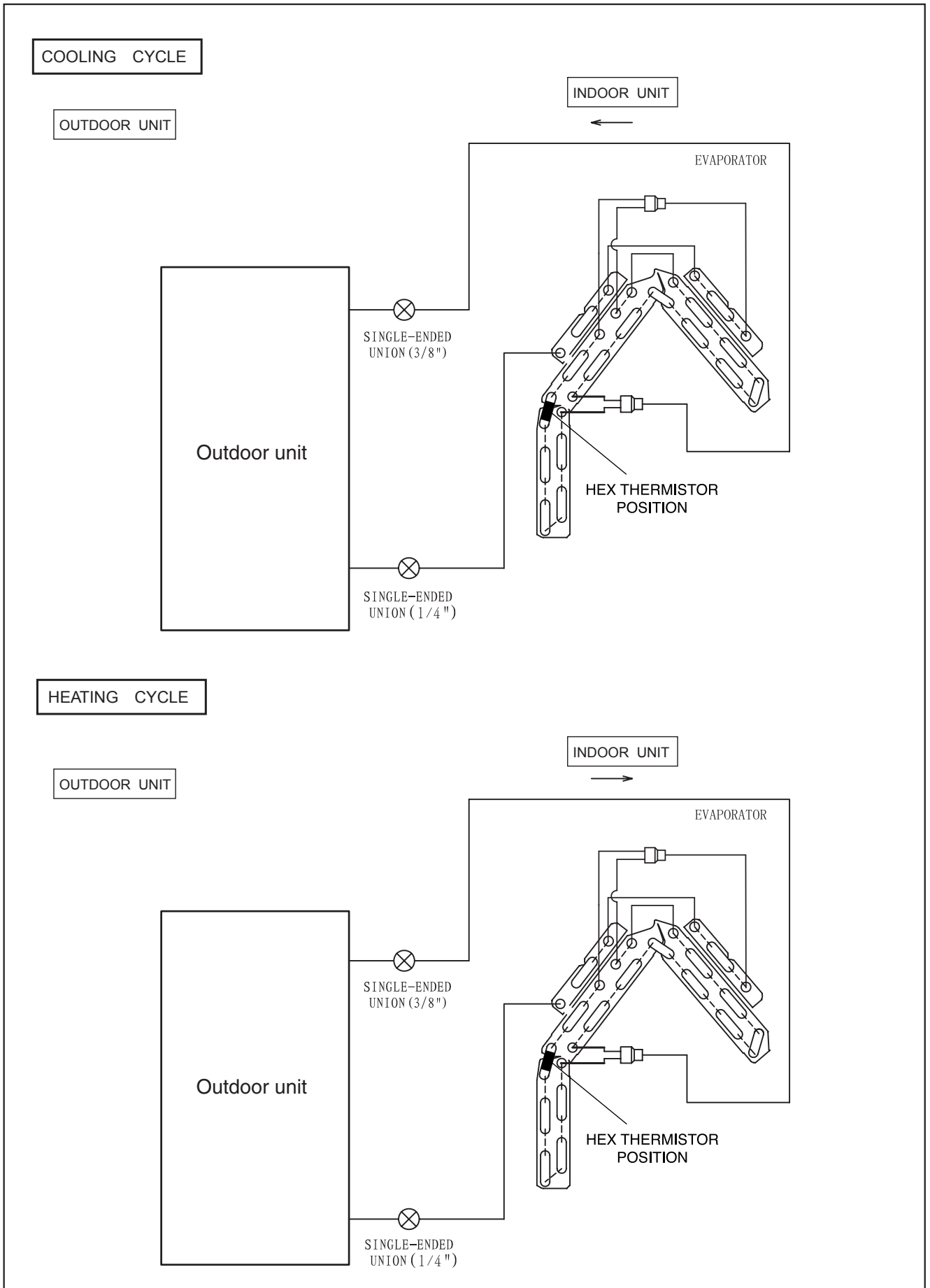


## Notes:

- (1) The defrosting inhibit period is set as shown in the diagram below. When defrosting has finished once, the inhibit period is newly set, based on the outdoor temperature when the compressor was started. During this period, the defrost signal is not accepted.
- (2) If the difference between the room and outdoor temperature is large when defrosting is finished, the maximum compressor speed (WMAX) or (WMAX2) can be continued for 120 minutes maximum.
- (3) The defrosting period is 20 minutes maximum.
- (4) When operation is stopped during defrosting, it is switched to auto refresh defrosting.
- (5) Auto refresh defrosting cannot be engaged within 15 minutes after operation is started or defrosting is finished.

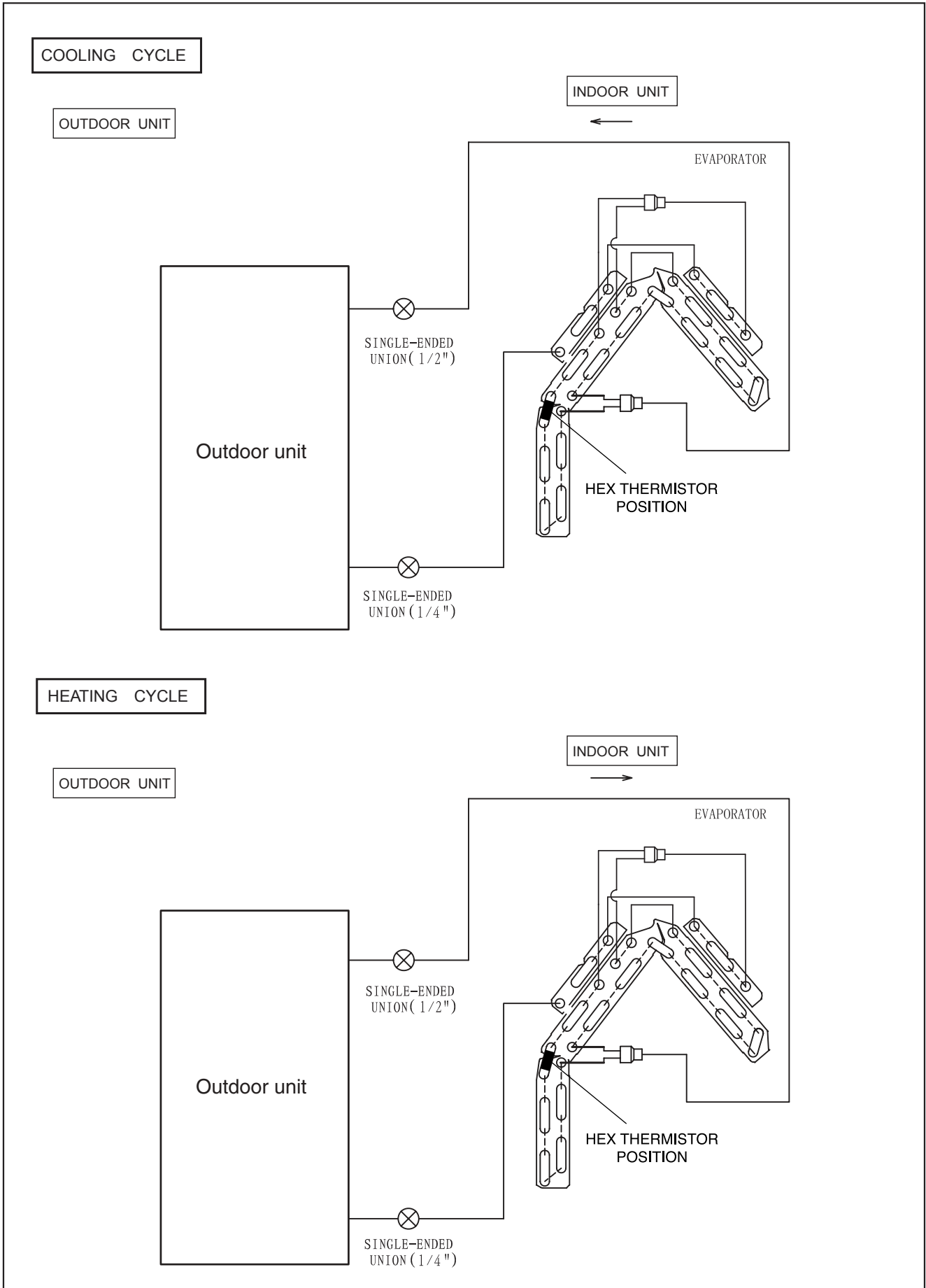
# REFRIGERATING CYCLE DIAGRAM

MODEL RAK-18QXD,RAK-25RXD,RAK-35RXD



# REFRIGERATING CYCLE DIAGRAM

MODEL RAK-50RXD



# Procedure for Disassembly and Reassembly

## INDOOR UNIT

RAK-18QXD, RAK-25RXD  
RAK-35RXD, RAK-50RXD

### 1. Front Panel

(1) Be sure to hold the front panel with both hands to detach and attach it.

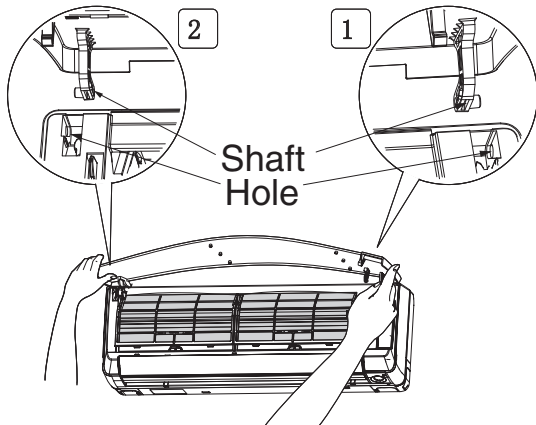


Fig. 1

When the front panel is fully opened with both hands, push the right arm to the inside to release it, and while closing the front panel slightly, put it out forward.

### 2. Front cover

- (1) After removing the screw of fixing the terminal cover, hold the handle of terminal cover and remove it.
- (2) After removing two screws, pull the center of the front cover and release the claws.
- (3) Pull the side faces (lower sections) of the front cover as shown in the figure and remove the cover.

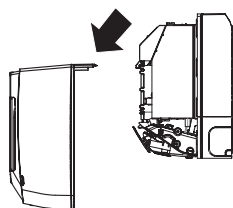
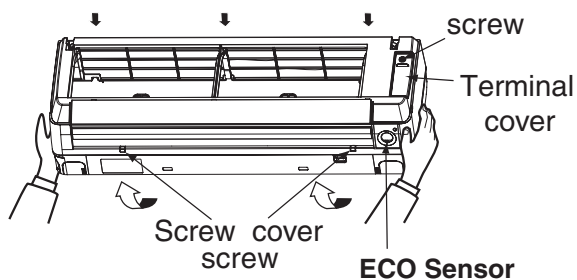
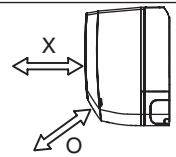


Fig. 2

## CAUTION

- Remove and attach the front cover to the direction as shown in the figure to ensure no damage occurs to the ECO sensor.



### 3. Control P.W.B. and Indicating P.W.B.

- (1) Remove each connector from the lead wire.
- (2) Remove the four P.W.B. supports from the control P.W.B.
- (3) Pull the support hook at the upper side of the indication lamp of the indicating P.W.B. and pull out the P.W.B. forward.

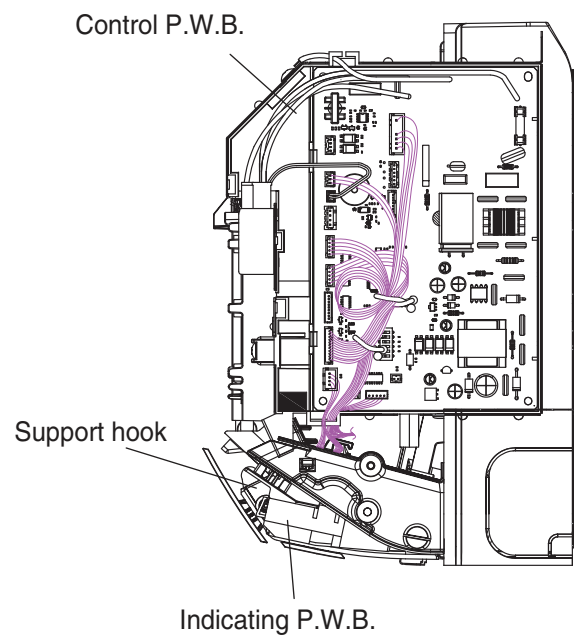


Fig. 3

#### 4. Tangential air flow fan and fan motor

- (1) Press to lower the hook at the center of the unit a little and pull the claw forward to remove the drain pan.

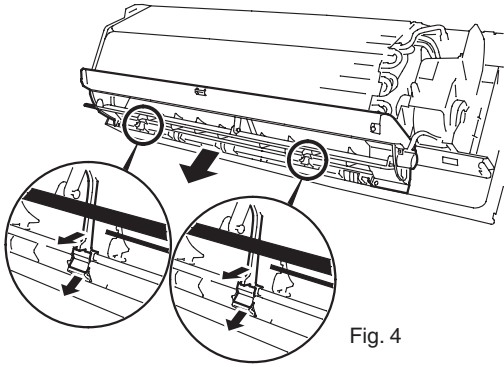


Fig. 4

- (2) Remove the screws from the upper and lower bearing covers.
- (3) Remove the locking hook of the lower bearing cover from the Cabinet.

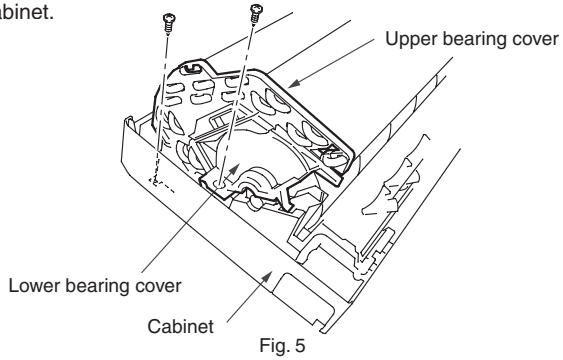


Fig. 5

- (4) Remove two lock screws from the fan motor holder.
- (5) Pull up the evaporator by holding it at the lower side. Insert a screwdriver through the space between the evaporator and drain chute and loosen the fan lock screw to remove the fan and fan motor.

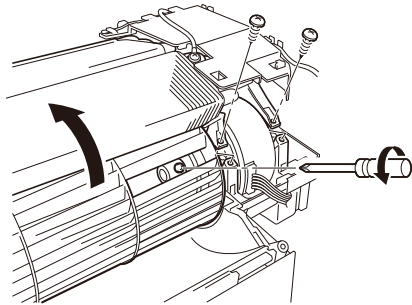


Fig. 6

# DESCRIPTION OF MAIN CIRCUIT OPERATION

MODEL RAK-18QXD,RAK-25RXD,RAK-35RXD,RAK-50RXD

## 1. Control power circuit

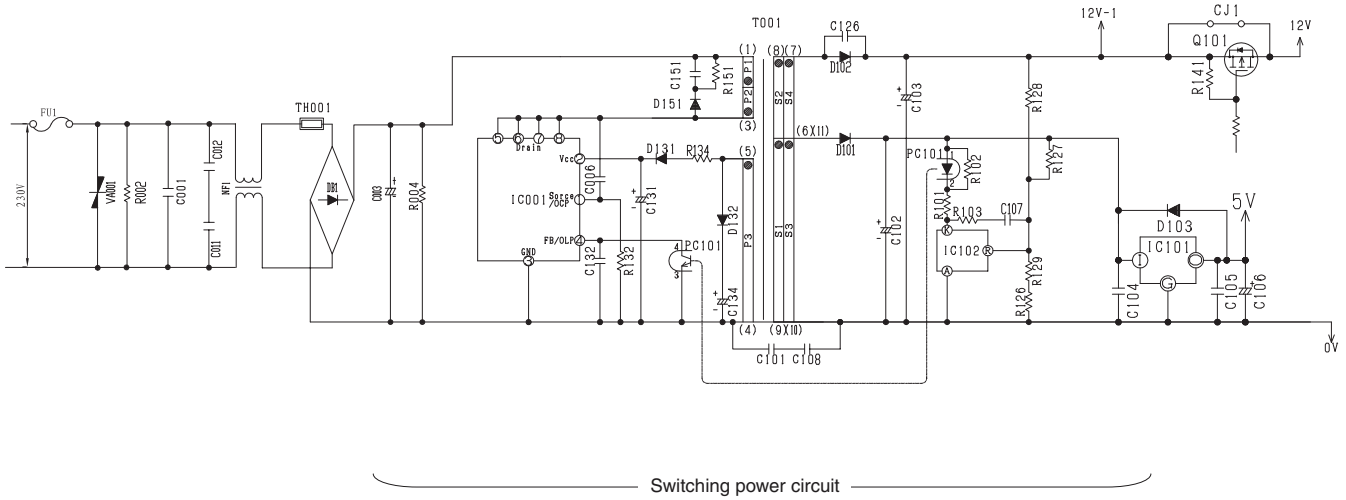


Fig. 1-1

- An AC power supply from outdoor unit passes through the 3.15 A fuse, varistor (VA001), and noise filter circuit and rectified and smoothed by DB1 and C003 to become a DC current 325 V. It is then supplied to indoor fan motor drive circuit, and switching power circuit.
- The switching power circuit, as controlled by IC001, drives the primary winding of the transformer (T001) to produce a specified voltage at the output winding. [The output terminal (pin ⑤) of IC001 has a switching voltage. But it changes in voltage peak and oscillation period depending on the power load. usually, the oscillation frequency when the air condition operation is about 67 kHz. In the standby state, the oscillation frequency is lowered to a level as low as 20 kHz or so to reduce the standby power.]
- The outputs of the output windings of the transformer is rectified and smoothed to become DC voltages at primary 18.5 V, 12 V, and 8.5 V respectively. The primary 18.5 V is supplied to the drive circuit of the indoor fan motor, the 12 V is supplied to each vane motor and to the drive circuits of the cleaning unit driving motor and other equipment, and the 8.5 V is adjusted to a stable 5 V by the 3-terminal regulator IC (IC101) and supplied to the microcomputer peripheral circuit.

### Check

If a failure in a part or circuit has produced an abnormal current in the power supply, the 3.15 A fuse will melt down to prevent further damage. If the 3.15 A fuse melts down, check the indoor fan motor, switching electrical circuit, and other components and replace any defective part.

### Check

If an abnormally high voltage is applied to the power supply, the 3.15 A fuse and varistor (VA001) will prevent further damage. If a high voltage results in the 3.15A fuse melted down, the varistor (VA001) should have deteriorated and destroyed. Therefore replace it at the same time.

### Caution

The primary circuit of the transformer (T001) has a voltage to ground. Guard against electric shocks.

## 2. Reset Circuit

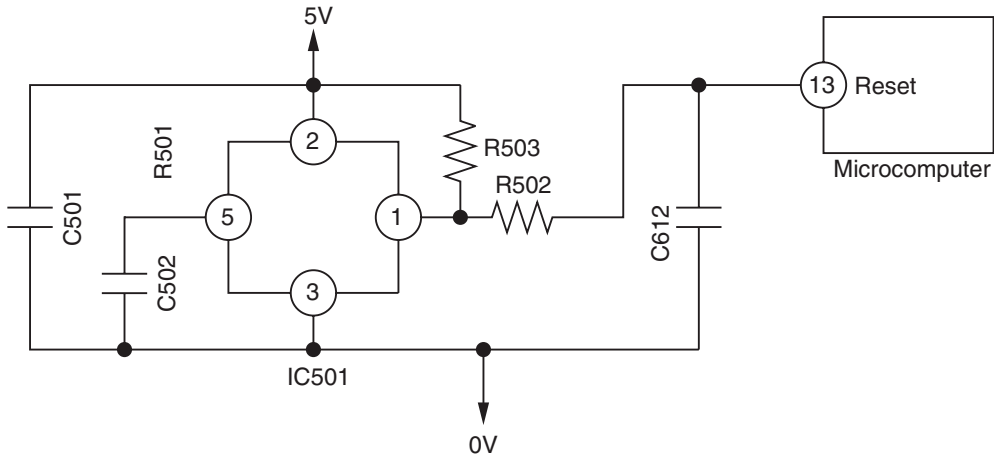


Fig.2-1

### Timing chart

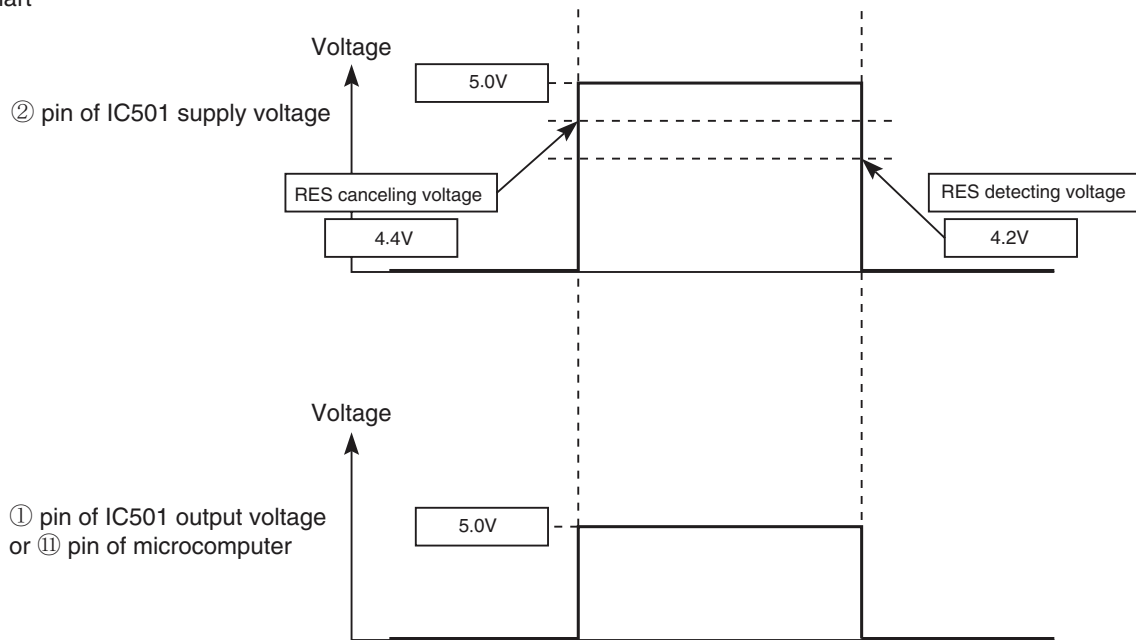


Fig.2-2

- Reset circuit is to initialize the indoor unit microcomputer when switching ON the power or after recovering from power failure.
- Microcomputer operates when ⑬ pin of the indoor unit microcomputer (reset input) is "Lo" for resetting and "Hi" for heating.
- Waveform of each part when switching ON the power and when shutting down is shown in the Fig. 2-2.
- After switching ON the power, ① pin of IC501 supply voltage and ⑬ pin of microcomputer becomes Hi when DC5V line rises and reaches approximately 4.4V or higher. Then, resetting will be cancelled and microcomputer starts operating.
- After shutting down the power, ① pin of IC501 supply voltage and ⑬ pin of microcomputer becomes Lo when DC5V line falls and reaches approximately 4.2V or lower. Then, the microcomputer will be in reset condition.



### 3. Drive circuit of the indoor fan motor

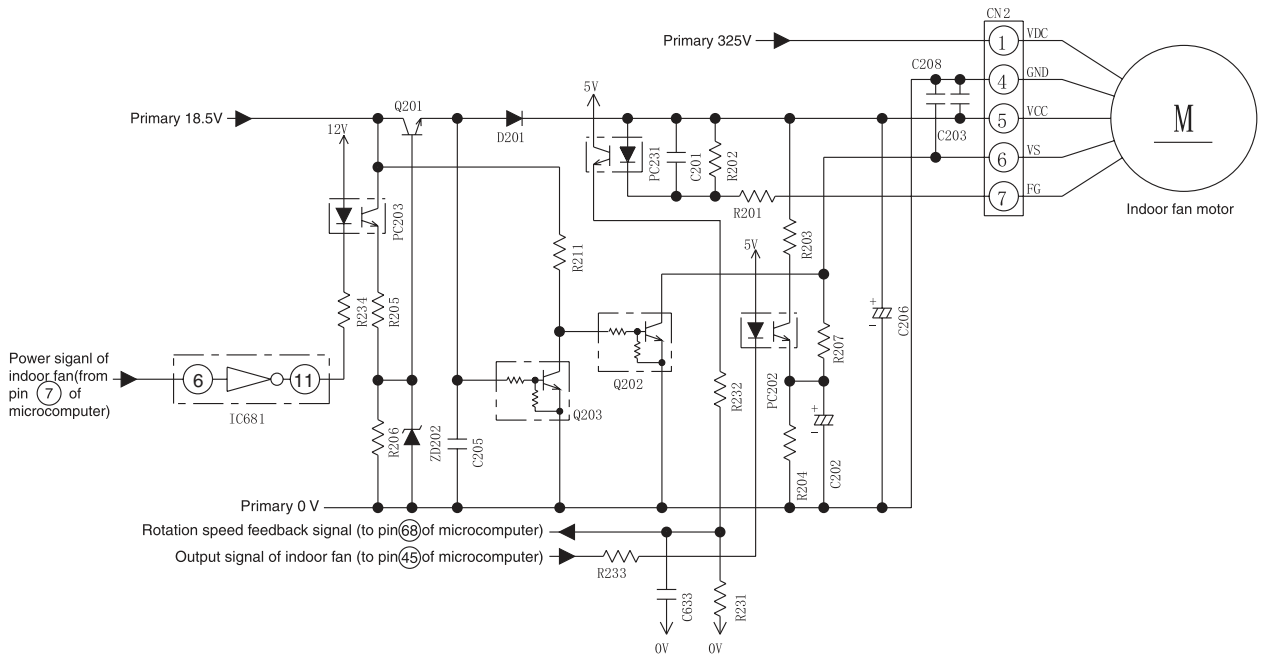


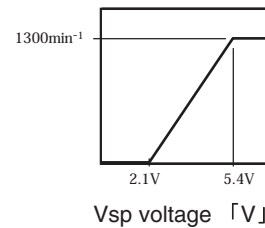
Fig. 3-1

< The circuit check (For test) >

Name	Test point	Test voltage
Motor drive power	CN2 ① pin- ④ pin	About 325V
Motor control power	CN2 ⑤ pin- ④ pin	About 15V
Motor speed signal	CN2 ⑥ pin- ④ pin	About 2-6V
Motor rotation speed debug	CN2 ⑦ pin- ④ pin	About 7.5V

- \* The voltage above is all motor operation vol. when you start the test, take care of your connector, do not touch the different pin together.
- \* The voltage of pin ⑥ - pin ④ , pin ⑦ - ④ maybe different from above.

< Pin 6 - Pin 4 voltage one example >



- \* The different mode maybe have different FAN rotation speed.

< Typical circuit waveform >

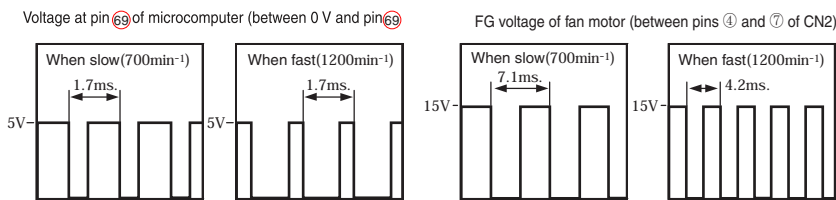


Fig. 3-2

- The indoor fan motor receives VDC (motor drive power supply), VCC (power supply for the control circuit inside the motor), and VS (speed command voltage) from CN2. The indoor fan motor returns an FG signal of a frequency that matches the rotation speed.
- VCC stabilizes the primary 18.5 V power supply into 15 V by using Q201 and supplies it.
- While on standby for a remote control signal, the Q201 shuts down the VCC and reduces the standby power.
- The VS receives a command voltage from the microcomputer. The VS terminal undergoes an analog voltage that matches the Lo level time ratio of the pulse signal from pin ④5 of the microcomputer. (See Fig. 3-2.)
- The FG terminal undergoes a signal of 12 pulses per revolution of the motor shaft. By counting the pulse rate, the microcomputer recognizes the motor speed, thereby performing feedback control.

**Caution**

The indoor fan motor and drive circuit are connected to the primary power supply. They therefore have voltage to ground. Guard against electric shocks.

**Caution**

While the product is energized, do not under any circumstances detach or reattach a connector. Any such practice would cause a high voltage to run, resulting in the indoor fan motor and board circuit being destroyed. (Check the discharge of the C003 before detaching or reattaching the connectors.)

### 4. Buzzer Circuit

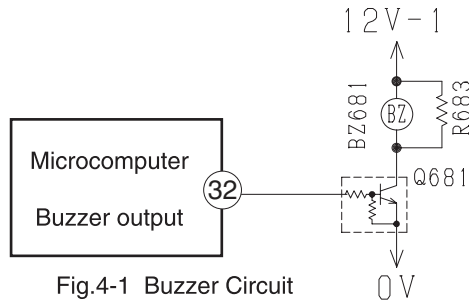


Fig.4-1 Buzzer Circuit

- When the buzzer sounds, an approx. 3.9kHz square signal is output from buzzer output pin (32) of the micro computer. After the amplitude of this signal has been set to 12Vp-p by a transistor, it is applied to the buzzer. The piezoelectric element in the buzzer oscillates to generate the buzzer's sound.

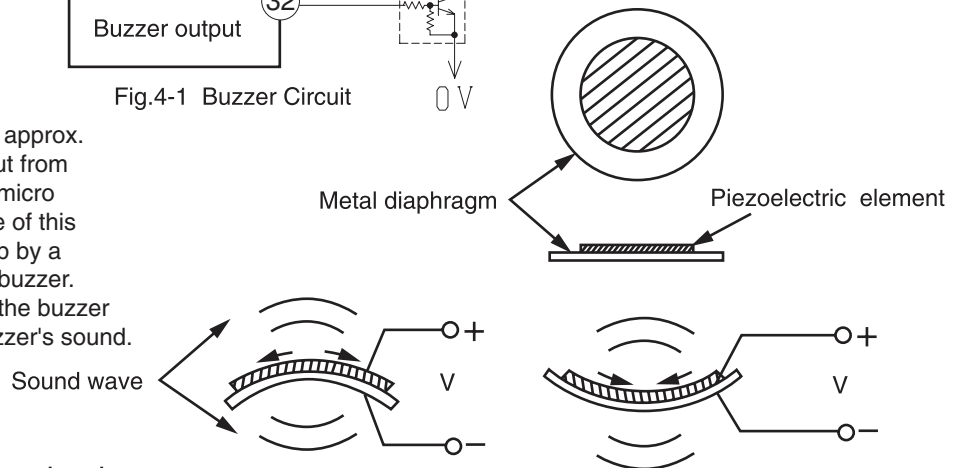


Fig.4-2 Buzzer Operation

### 5. Remote control reception circuit

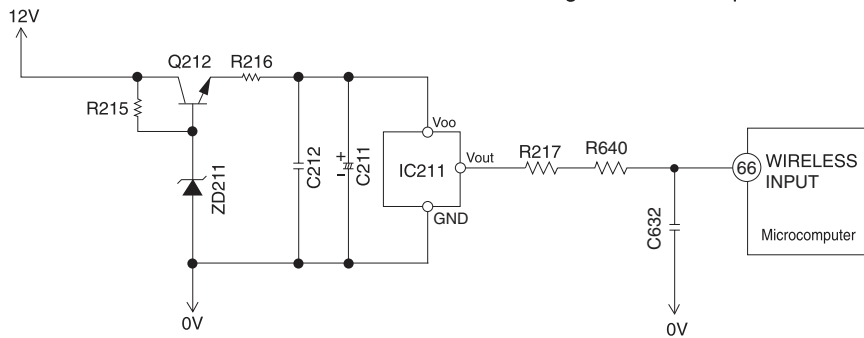


Fig.5-1

[Typical communication waveform]

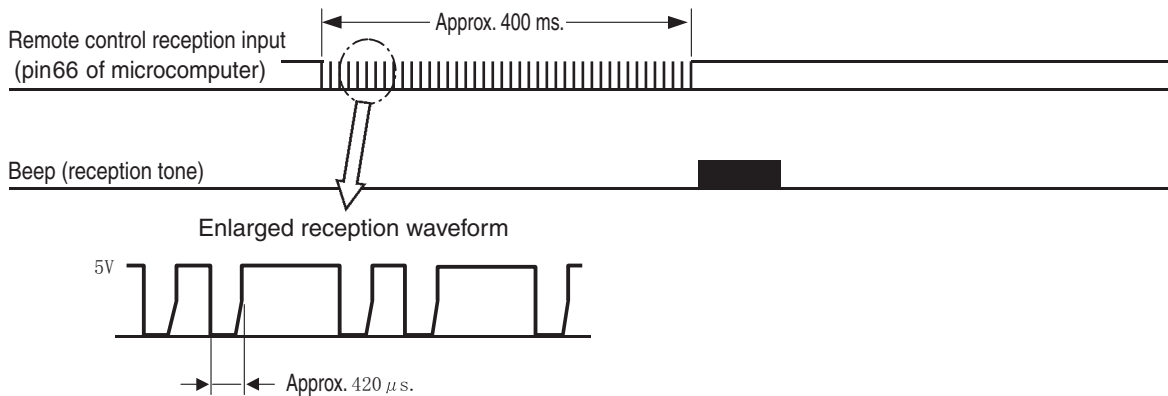


Fig. 5-2

- An infrared signal from the remote control unit is converted to an electrical signal by the remote control light-receiving unit (IC211) and is received by the microcomputer. Data is transmitted as digital data 0 and 1 by changing the interval of the basic pulses at about 420μs.

## 6. Initial Setting Circuit (IC531)

- When power is supplied, the microcomputer reads the data in IC531 (E<sup>2</sup>PROM) and sets the preheating activation value and the rating and maximum speed of the compressor, etc. to their initial values.
- Data of self-diagnosis mode is stored in IC531; data will not be erased even when power is turned off.

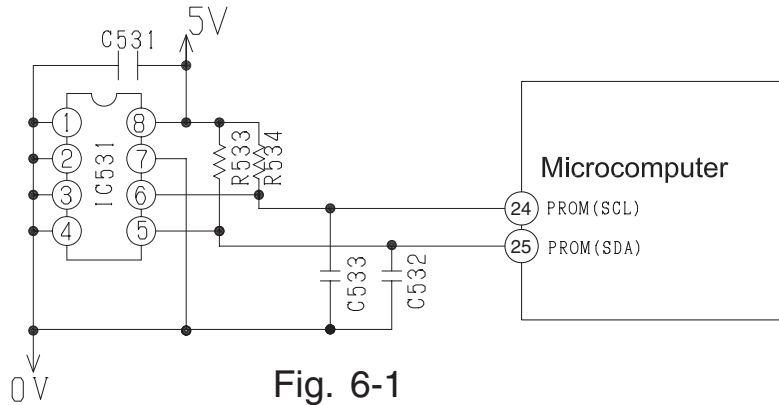


Fig. 6-1

## Initial Setting Circuit (IC531 and IC532) - For RAK-18QXD only

- When power is supplied, the microcomputer reads the data in IC531 and IC532 (E<sup>2</sup>PROM) and sets the preheating activation value and the rating and maximum speed of the compressor, etc. to their initial values.

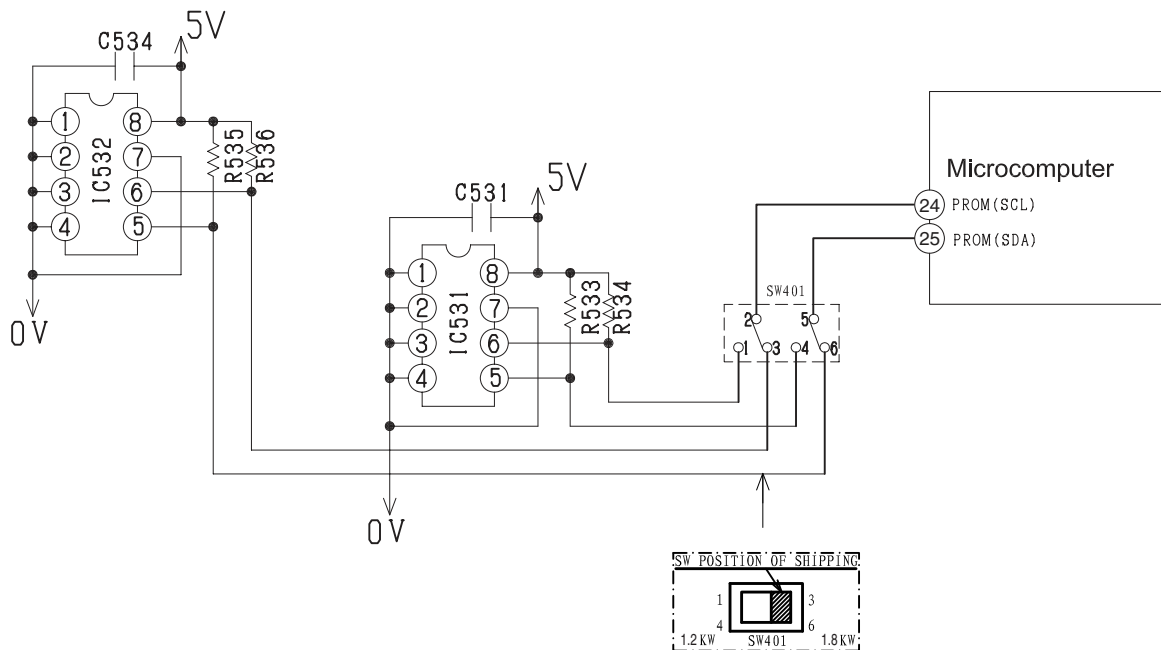


Fig. 6-2

SW401 will act as a program selector for 1.2kW and 1.8kW. When switch is turn to position(1 4), IC531 will be selected as 1.2kW mode. When switch is turn to position(3 6), IC532 will be selected as 1.8kW mode.

## 7. Temporary Switch Circuit

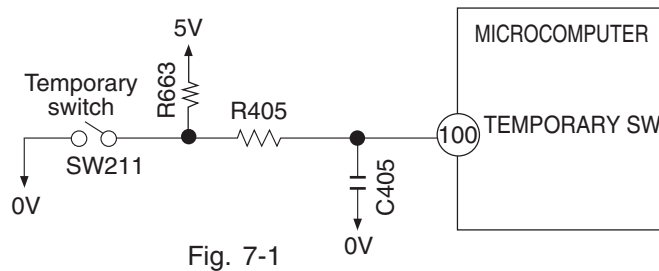


Fig. 7-1

- The temporary switch is used to operate the air conditioner temporarily when the wireless remote control is lost or faulty.
- The air conditioner operates in the previous mode at the previously set temperature. However, when the power switch is set to OFF, it starts automatic operation.

## 8. Room Temperature Thermistor Circuit

A room temperature thermistor circuit is shown in Fig. 8-1.

According to room temperature, the voltage of point (A) becomes as it is shown in Fig.8-2.

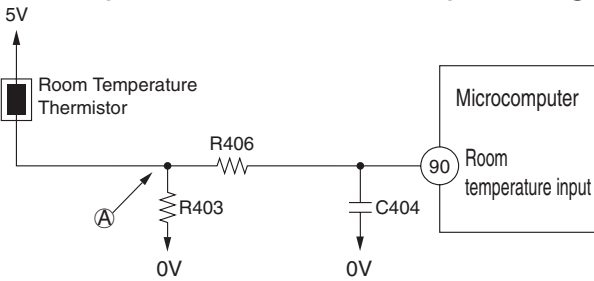


Fig. 8-1

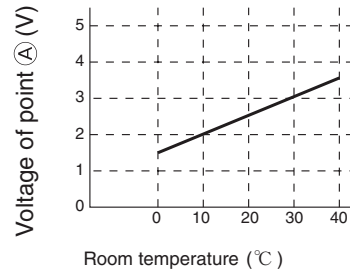


Fig. 8-2

## 9. Heat Exchanger Thermistor Circuit

Heat exchanger temperature is noticed inside the room

- (1) Preheating
- (2) Low-temperature defrosts at cooling and dehumidification operation time.
- (3) Not working of reversing valve or detection of opening of heat exchanger thermistor is controlled.

According to heat exchanger temperature, the voltage of point(A) becomes as it is shown in Fig. 9-2.

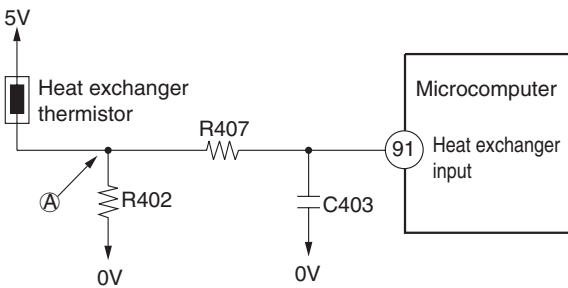


Fig. 9-1

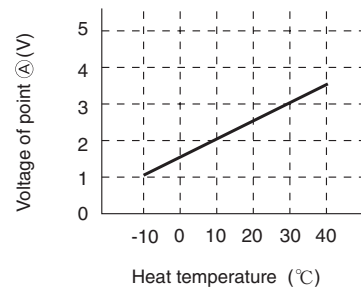


Fig. 9-2

## 10. Dip-switch

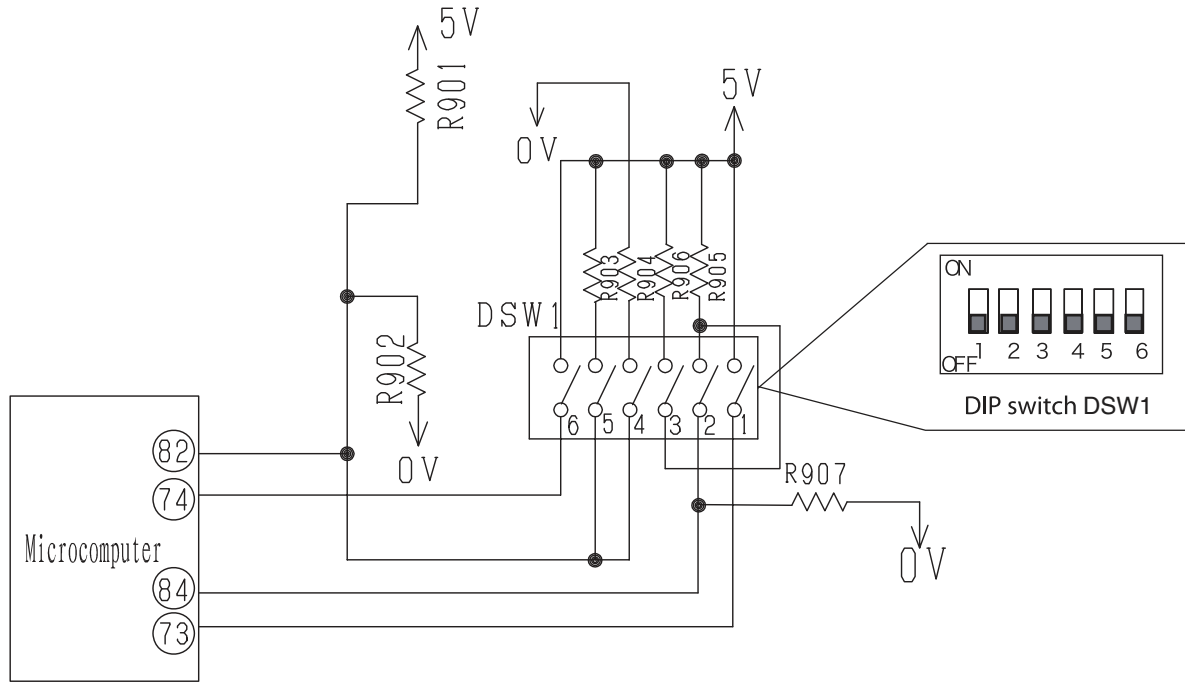


Fig.10-1 Dip switch Circuit

- Fig.10-1 shows the dip switch circuit; the table shown in Fig.10-2 are function and setting position from ① – ⑥ of the switch no.

SW No.	I T E M	F U N C T I O N							
1	AUTO RESTART	OFF *	ENABLE	ON	DISABLE				
2	CARD KEY MODE	OFF *	DISABLE		ON	ENABLE			
3	CARD KEY LOGIC SELECT	OFF *	INPUT HIGH ACTIVE		ON	INPUT LOW ACTIVE			
4	HEATING/COOLING ONLY MODE SELECT	OFF *	HEATING & COOLING	OFF	HEATING ONLY	ON	COOLING ONLY	ON	HEATING & COOLING
5	HEATING/COOLING ONLY MODE SELECT	OFF *		ON		OFF		ON	
6	NOT USED								

Fig.10-2 Functions of Dip switch

NOTE:

\* Marking is position of shipping [FACTORY default setting]

# 11. Indoor/outdoor communication circuits

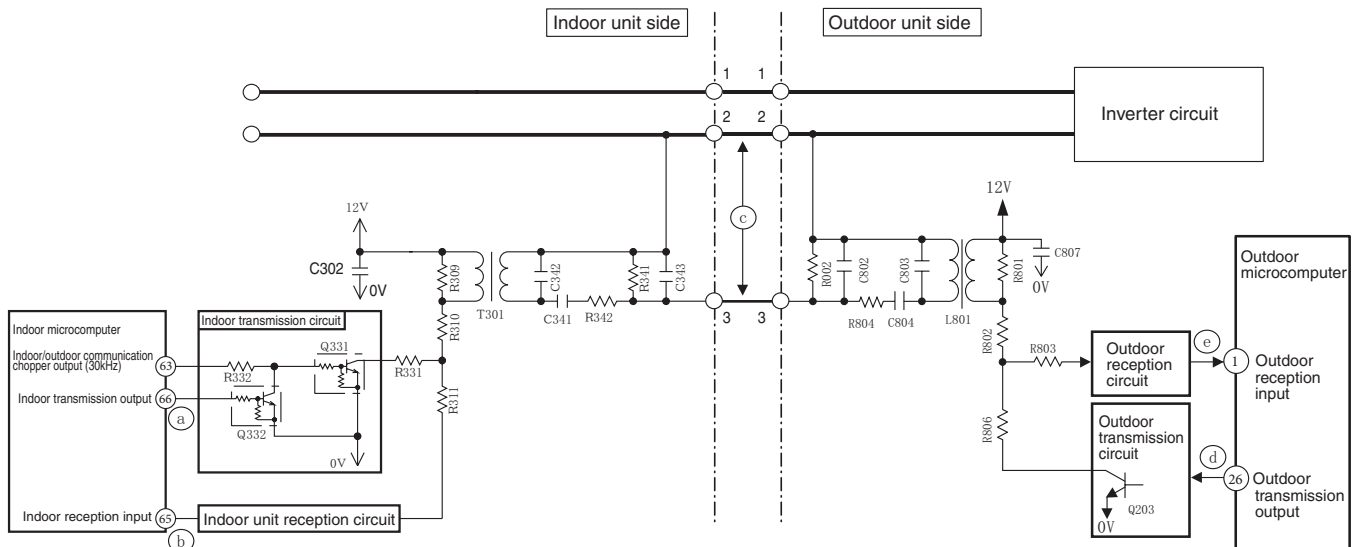


Fig. 11-1

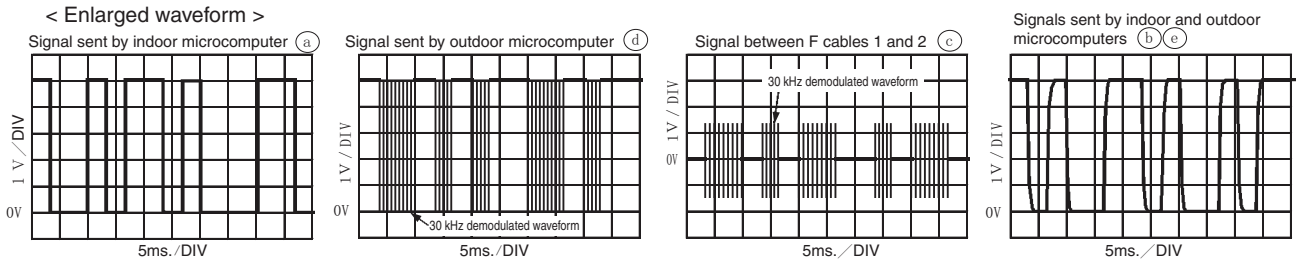
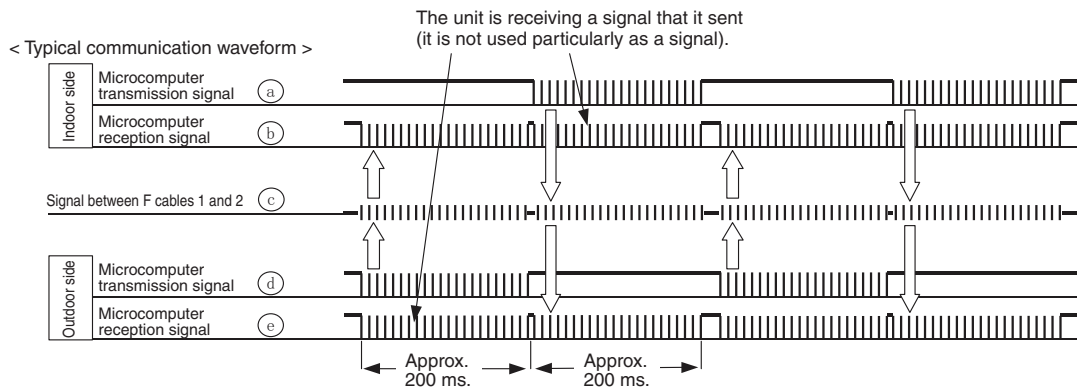


Fig. 11-2

- Indoor and outdoor communications are conducted by using lines 2 and 3 of F cable. Line 2 of F cable is shared with a transmission channel that powers the outdoor unit.
- Data communicated between the indoor and outdoor units are outputted from the microcomputer as serial signals and are transmitted as demodulated by a 30 kHz carrier wave. (Both the indoor and outdoor microcomputers directly output a signal demodulated at 30 kHz.)

**Check**

If a cable poorly inserted in the indoor terminal board or some other failure overheats the terminal board and the temperature fuse of the terminal board blows out, the power to the indoor communication circuit will be shut down to stop the communications function. (In that case, the failure will be displayed by the timer lamp blinking 3 times.)

**Check**

If communication fails between the indoor and outdoor units for some reason, the product will give a self-diagnosis display either by "the timer lamp blinking 3 times" or "the timer lamp blinking 12 times" depending on the cause.

## 12. Stepping motor drive circuit

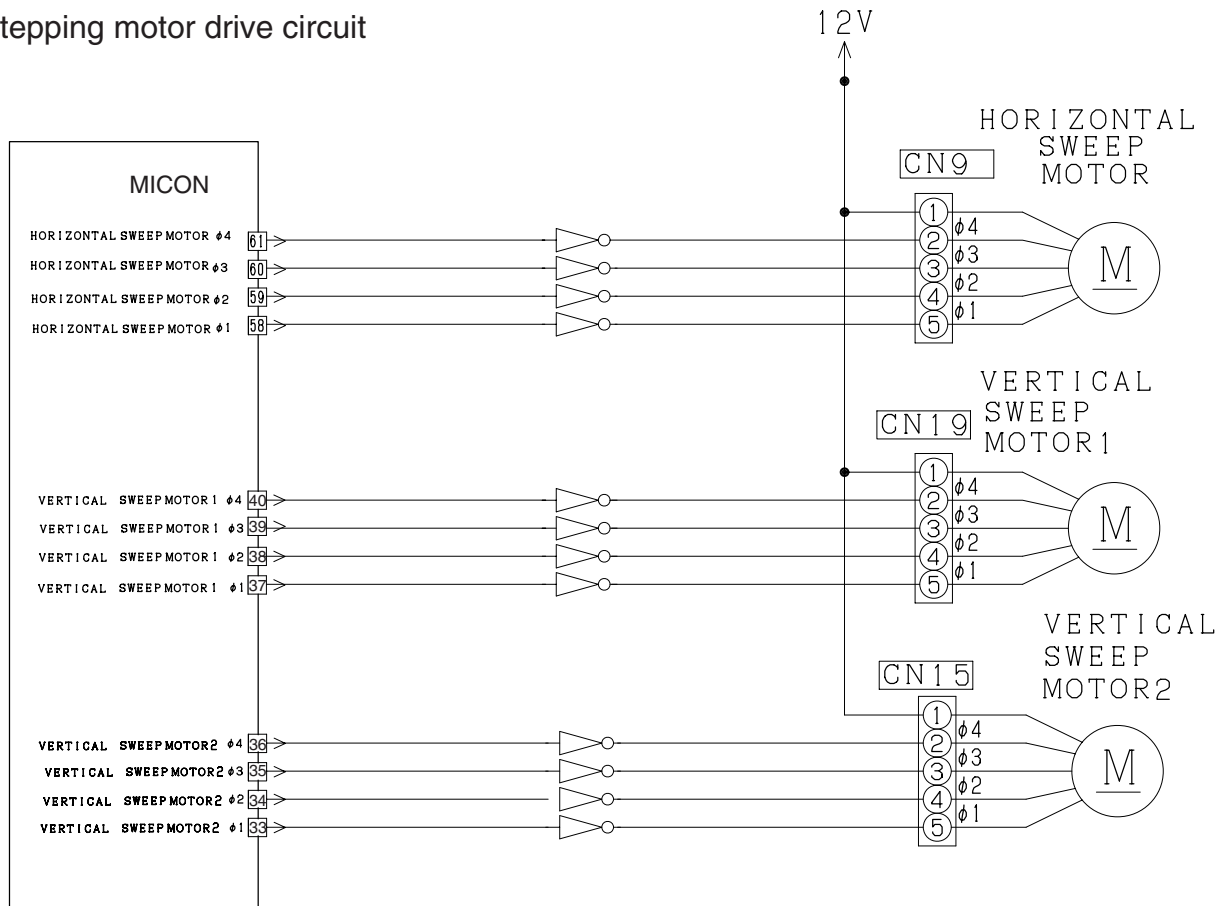


Fig. 12-1

[Connector circuit waveform while the motor runs]

Voltage waveforms of different phases as viewed from the OV line while the motor rotor is turning counterclockwise as viewed from the shaft side

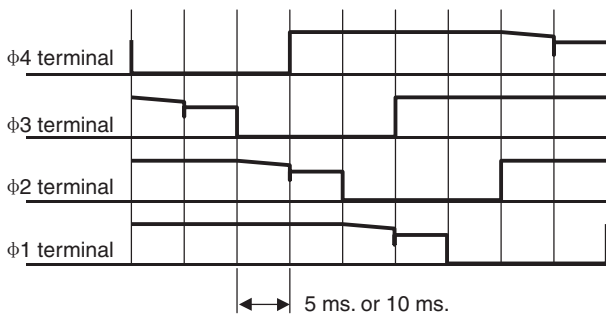


Fig. 12-2

- Each stepping motor runs as excited in 1 or 2 phases at 100 PPS or 200 PPS.
- The excitation pattern passes the microcomputer (MICON) and then the driver IC and excites the coil of each stepping motor.
- Some models not need to install the horizontal sweep motor.

### 13. Infrared human presence sensor circuit

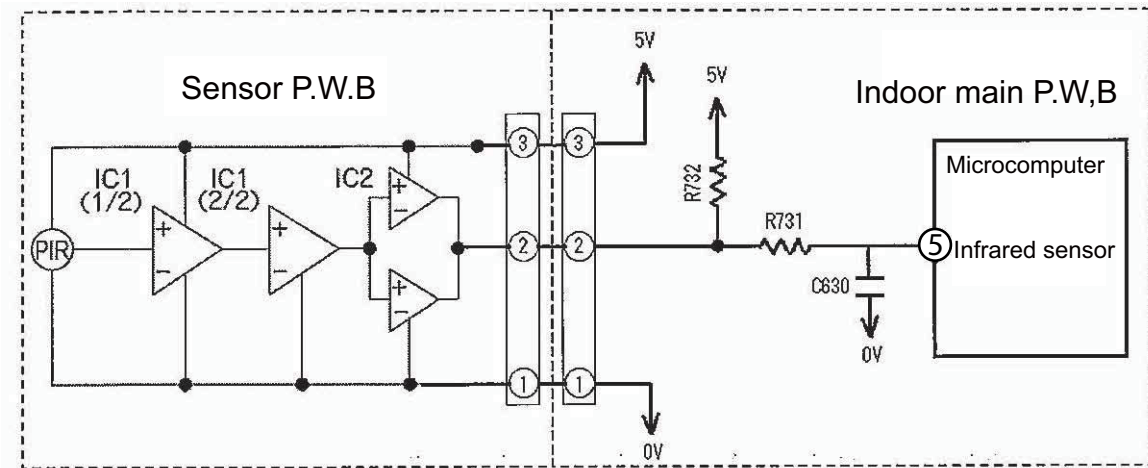


Fig.13-1

- With the infrared sensor, the air conditioner can detect the activity level in a room and adjust the temperature and humidity automatically, thus achieving the purpose of energy saving.
- When the activity level in a room is detected, the infrared sensor will be in operation. And a low-voltage output from the infrared sensor P.W.B. will be magnified by the amplifier comparator and be transformed the digital signal to microcomputer (IC601). (The infrared sensor output is [Hi] when the activity level is not detected. On the contrary, output is [Lo].)
- If the connector (CN21) is not inserted, it will be considered as no infrared sensor, and no self-diagnosis indication.



## SERVICE CALL Q&A

MODEL RAK-18QXD,RAK-25RXD,RAK-35RXD,RAK-50RXD

### Cooling operation

**Q1** The compressor sometimes stops during cooling.

**A1** Check if the heat exchanger of the indoor unit is covered with frost. Wait for 3 to 4 minutes until the frost disappears.

Cooling when the room temperature is low may cause the heat exchanger of the indoor unit to gather frost.

### Dehumidification

**Q1** The indoor unit produces a noise that goes "shaaahhh" during dehumidification.

**A1** That is a noise produced by refrigerant flowing through the pipe.

**Q2** Cold air comes out during a dehumidifying operation.

**A2** To improve the dehumidification efficiency performs quiet fan operation. Therefore the air is cold and it is not a malfunction.

**Q3** The operation does not stop even by setting the temperature higher than room temperature on the remote controller.

**A3** It sets to perform dehumidifying operation by setting the temperature slightly lower than remote controller setting.

### Heating operation

**Q1** The product sometimes fails to produce a wind during heating.

**A1** Defrosting is in progress. Wait 5 to 10 minutes until the frost on the outdoor unit disappears.

**Q2** The product begins with a slight fan speed during heating even though set to "Hi fan" or "Med fan" or "Low fan" or "silent fan".

**A2** At the first of the heating, the product will run for 30 seconds with a slight fan speed. When set to strong fan speed, the product will begin with a slight fan speed operation, producing a weak fan speed for 30 seconds, and then switch to strong fan speed.

**Q3** The product stops during heating even though it is set to "30°C."

**A3** When heating is conducted despite the high outdoor temperature, the product may stop to protect its equipment.

### Auto-fresh defrost

**Q1** During heating, I turned off the product by using the START/STOP button. But the "operation lamp" is blinking and the outdoor unit is running.

**A1** The "auto-fresh defrost" should be working. When stopped, the product will check its outdoor unit for frost and, if there is any frost, conduct defrosting and then stop operating.

### Automatic operation

**Q1** During an automatic run, switching the fan speed selector will not change the fan speed.

**A1** The product will switch automatically to automatic fan speed. You cannot select strong or weak fan speed by remote control but you can select fan speed and quiet.

**Q2** How is the automatic operation mode determined?

**A2** According to the room temperature, heating or cooling operation is automatically selected. Refer to the basic operation section.

Common, etc.

**Q1** In "automatic fan speed" mode, the indoor fan changes from strong fan speed to weak fan speed to slight fan speed.



**A1** This does not abnormal. It is because the cold fan speed prevention is working.

In fan speed "automatic" mode, the product will sense the heat exchange temperature and, when the temperature goes down, the product will automatically switch to strong wind to weak fan speed to slight fan speed.

**Q2** At operation startup, the outdoor unit becomes noisy.



**A2** At operation startup, the product will set the rotation speed of the compressor to full power and increase its heating and cooling capacity, resulting in a slightly higher noise level. This is not a sign of a breakdown.

**Q3** The outdoor unit sometimes changes in its noise.



**A3** The difference between the thermometer temperature setting and room temperature will change the rotation speed of the compressor. This is not a sign of a breakdown.

**Q4** There is a difference between the temperature setting and room temperature in room temperature control.



**A4** The room structure, air stream, or other factor may cause a gap between the room temperature setting and actual room temperature. If there is any difference between the setting and the room temperature, adjust the temperature setting to match the living space to a comfortable temperature.

**Q5** The product will not produce wind right after startup.



**A5** After turning ON the power switch or breaker, setting the product to heating or dehumidification will activate a preliminary operation for 1 minute. At that time, heating will cause the operation lamp to blink. This is not a sign of a breakdown.

**Q6** I performed internal cleaning, but didn't succeed in controlling the mold in the room.



**A6** Internal cleaning will clean the inside of the indoor unit of the air-conditioner, thereby controlling mold generation. This will not control the mold in the room.

## Wireless remote control

**Q1** The timer will not become set.



**A1** Have you set the product to the current time? The timer cannot be set unless it is set to the current time.

**Q2** The current time display will disappear at once.



**A2** The current time disappears 10 seconds later. The timer set display is given priority.

When set to the current time setting, the reading blinks for about 3 minutes.

**Q3** I made a timer "reservation". But the time setting has disappeared.



**A3** Is the time not past the reserved time? The set time disappears when the current time reaches the reserved time.

**Q4** I tried to set the "sleep" timer while the ON timer is reserved. But it will not set itself to a desired time.



**A4** The time set in the "sleep" timer can be set with a time up to the time set with the ON timer. If the end time of the "sleep" timer is past the time set with the ON timer, you cannot make that setting.

**Q5** I set the "sleep" timer during operation. But  
① the indoor fan will not run (it will not produce wind)  
② wind intensity will not change.



**A5** ① This occurs when the room temperature and humidity have reached their settings during dehumidification and the air-conditioner is in a pause. The product will begin again to run within about 3 minutes.  
② The product will run with the wind speed set to a "quiet" state.

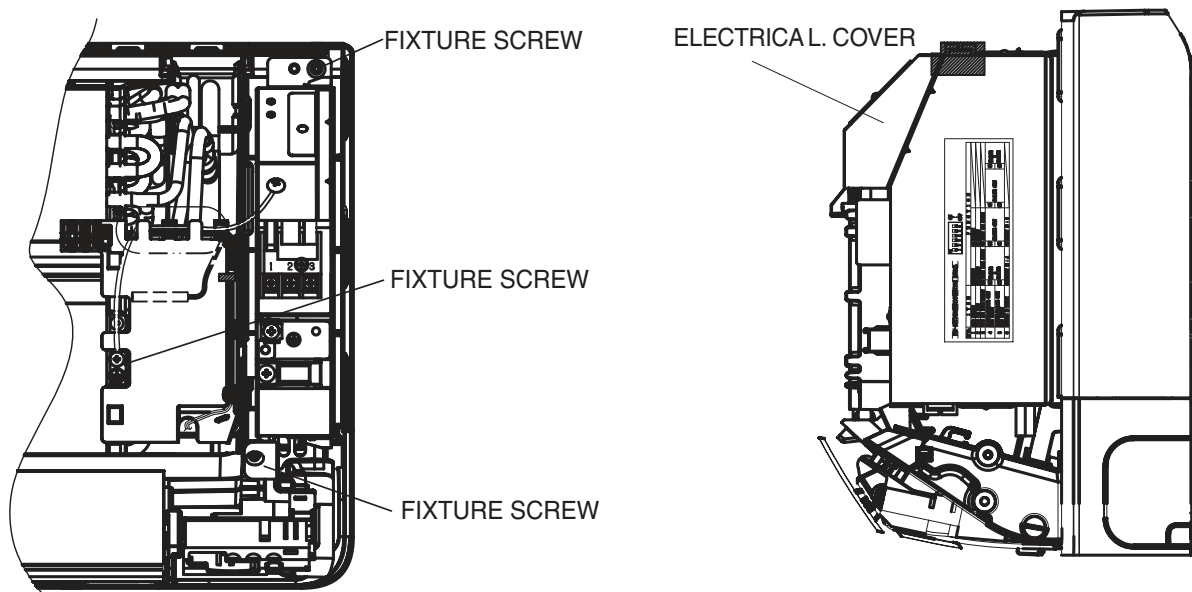
**Q6** I tried to change the setting with the "room temperature" button of the remote control unit in vain.



**A6** You cannot make this setting when the product is in "air purification" mode. Moreover, you cannot set the product to a desired setting when quick laundry or dew control is being performed with the "auto" or "quick dehumidification" button.

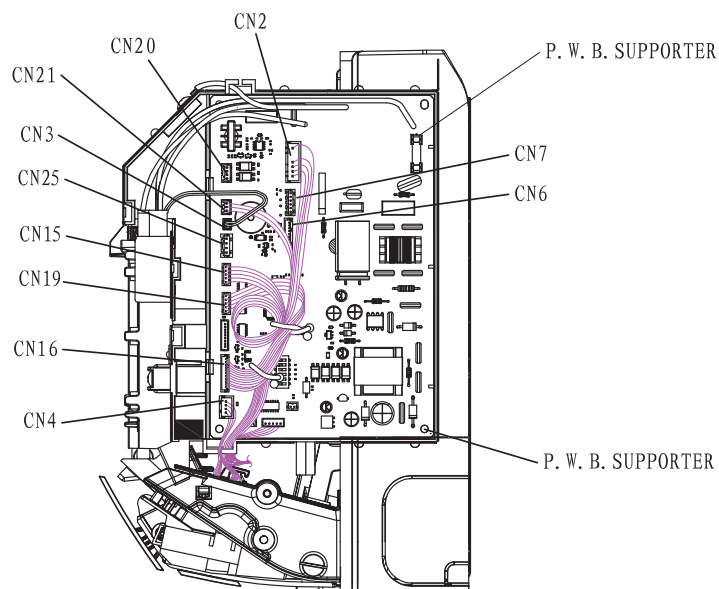
# STRUCTURE OF AN INDOOR UNIT ELECTRIC PARTS

RAK-18QXD,RAK-25RXD,RAK-35RXD,RAK-50RXD



## Removing electrical parts

1. Remove the electrical parts cover.
2. Remove the connectors from the CN4 (heat exchange thermistor), CN9、 CN15、 CN19 (stepping motor) , CN2 (fan motor)and CN16 ( P. W. B. (INDICATION) ).
3. Remove three lock screws.



## Removing control P.W.B.

1. Remove the connectors from the CN3.
2. Remove the P.W.B. from the P.W.B. support.

## Removing the indicating P.W.B.

1. Remove the connector from the CN16 on the control P.W.B.
2. Remove the upper hook from the indicating P.W.B. lock resin, pull the P.W.B. forward a little and remove it.

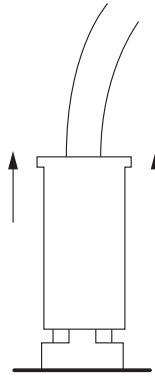
## Other instructions

### (1) Detaching and reattaching the receptacles for tab terminal

All the receptacles for connecting tab terminals are with a locking mechanism. Forcibly pulling any such receptacle without unlocking it will destroy it. Be on guard.

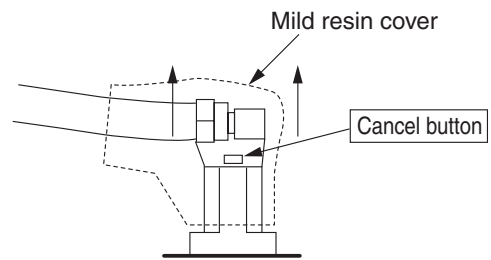
When reconnecting it, insert it securely all the way home.

#### · Receptacle types and how to unlock them



Vertical (with a resin case)

Hold the resin case and pull it out.



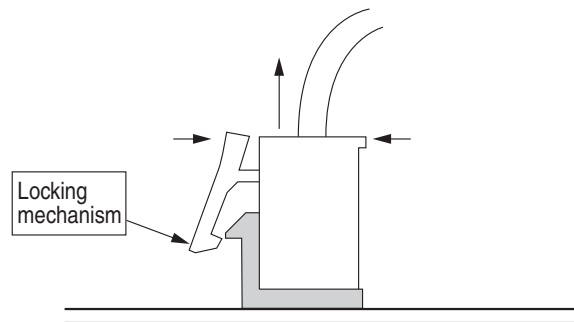
Horizontal (with a mild resin cover)

Hold the cancel button down on the mild resin cover while pulling it out.

### (2) Detaching and reattaching the board connector

The product comes equipped with many board connectors provided with lock mechanism. Forcibly pulling any such part without unlocking it will destroy it. Be on guard. When reconnecting it, insert it securely all the way home.

Pinch the locking mechanism with your fingers and pull it out unlocked.



### (3) Do not detach or reattach the connectors while energized

Do not under any circumstances detach or reattach the connectors while energized. That would destroy the board components and fan motor. For both the indoor and outdoor boards, ensure that the smoothing capacitor has discharged its electricity fully before you do your work.

## Troubleshooting support

No	Function	Description
1	Self-diagnosis display [Display on the indoor unit side]	<ul style="list-style-type: none"> <li>· The failure mode detected on the indoor unit side is displayed by blinking the "timer lamp". And a failure detected on the outdoor unit side will be indicated by the "time lamp" blinking 4 times.</li> <li>· If the outdoor unit side detects a failure, the product will first conduct several operation retrials. There are some failure modes with no lamp display while retrials are continued.</li> </ul> <p>[Failure mode where retrials are continued and the indoor unit lamp does not end up giving a display]</p> <ul style="list-style-type: none"> <li>OH thermistor heat-up</li> <li>Overload lower limit cut</li> <li>Low-frequency things</li> </ul>
	[Display on the outdoor unit side]	<ul style="list-style-type: none"> <li>· The failure mode detected on the outdoor unit side is displayed by blinking the "LD301". Detecting a failure will stop the outdoor unit and keep blinking the LD301 until it is restarted. (The communication error will persist until the communication is reestablished.)</li> </ul>
2	Self-diagnosis memory	<ul style="list-style-type: none"> <li>· The failure modes detected on the indoor and outdoor unit sides are stored in the nonvolatile memory of the indoor unit and can be read later on. (The memory will remain even after power-off.)</li> <li>· The failure modes detected on the outdoor unit side are written in memory every time any such mode occurs. The failure mode can therefore be detected on the indoor unit side without waiting for the retry frequency to reach the display of the indoor unit lamp. Moreover, the normal self-diagnosis display function which rarely occurs will store and display failure modes that do not end up displaying the indoor unit lamp. (Any such mode may be unable to be stored if indoor or outdoor communications is in a failure.)</li> <li>· The product stores 5 last-stored failure modes.</li> <li>· There is a function for deleting memory. Once you clear the memory and run the product for several days, you can read the failure modes and check them, thereby detecting the less frequent failure phenomena.</li> <li>· Failure modes can be checked by both the blinking of the lamp of the indoor unit and the display of the remote control liquid crystal display.</li> </ul>

※The "self-diagnosis function of the communication circuit" available in our conventional models is now incorporated as part of the normal self-diagnosis function. In the case of a failure in the communication circuit, you do not have to conduct a special operation and the operations can be automatically divided into 3 blinking operations and 12 blinking operations of the timer lamp. However, a strong external noise may have resulted in 12 times of blinking.

## Self-diagnosis display function (indoor side display)

While the "timer lamp" (orange), of the indoor unit is blinking, troubleshoot the product while referring to the table below.

- How to count the lamp blinking frequency
  - The product will repeat blinking with 2-second intermissions.
  - The blinking speed is as follows: on for 0.35 seconds and off for 0.35 seconds.

[An example of 5-time blinking]



- If you wish to try another operation while the lamp is blinking, operate the START/STOP button on the remote control unit twice. The first push will reset the indoor microcomputer, while the second will activate the product

### DESCRIPTION OF THE SELF-DIAGNOSIS INDICATION

REFER TO THE TABLE BELOW IF THE TIMER INDICATOR (ORANGE) IS BLINKING. THE SYMBOL "\*" MEANS, USUALLY THERE IS NO INDICATION, BUT IT WILL INDICATE ONLY WHEN REDISPLAY THE FAILURE MODE MANUALLY.

REFER TO THE TABLE BELOW IF THE HUMAN SENSOR INDICATOR (GREEN) IS BLINKING.

LAMP BLINKING MODE	MAIN DEFECTIVE
■ 2 sec ■ ----- ONCE	REFRIGERANT CYCLE DEFECTIVE
■ ■ 2 sec ■ ----- 2 TIMES	FORCED COOLING OPERATION
■ ■ ■ 2 sec ■ ----- 3 TIMES	INTERFACE DEFECTIVE (INDOOR)
■ ■ ■ 2 sec ■ ----- 4 TIMES	OUTDOOR UNIT DEFECTIVE
■ ■ ≪ ■ ■ 2 sec ■ --- 9 TIMES	INDOOR THERMISTOR DEFECTIVE
■ ■ ≪ ■ ■ 2 sec ■ --- 10 TIMES	ABNORMAL ROTATING NUMBERS OF DC FAN MOTOR
■ ■ ≪ ■ ■ 2 sec ■ --- 12 TIMES	INTERFACE DEFECTIVE (OUTDOOR)
■ ■ ≪ ■ ■ 2 sec ■ --- 13 TIMES	IC531 DEFECTIVE
■ ■ ≪ ■ ■ 2 sec ■ --- *20 TIMES	HUMAN SENSOR DEFECTIVE

LAMP BLINKING MODE	MAIN DEFECTIVE
■ ≪ ■ ≪ --- LIGHTING: 4SEC OFF : 1SEC	* HUMAN SENSOR SIGNAL DEFECTIVE

REFER TO THE TABLE BELOW IF THE INDOOR UNIT DOES NOT WORK AT ALL.

CHECK POINT	ACTION/REPLACEMENT PARTS, etc
FU1 (3.15A) FUSE BLOWN	REPLACE THE PART WHICH CAUSED BLOWING / DISCONNECTION OF FU1 (3.15A) FUSE
COME OFF OR DISCONNECTION OF THE CONNECTOR FOR INDICATING P. W. B	FIX CN16 CONNECTOR
FAILURE OF CONTROL P. W. B	REFER TO THE SERVICE GUIDE FOR HOW TO DETERMINE THE FAILED PART

( ■ --- LIGHTS FOR 0.35 SEC AT INTERVAL OF 0.35 SEC. )

\* IF THE INTERFACE CIRCUIT IS DEFECTIVE WHEN THE POWER IS TURNED ON, THE SELF-DIAGNOSIS INDICATION WILL NOT WORK.

\* IF THE INDOOR UNIT CAN NOT BE OPERATED AT ALL,











## SELF-DIAGNOSIS MEMORY FUNCTION



Failure modes are stored in the nonvolatile memory of indoor unit and shall be redisplayed by remote controller.

This function is useful in checking the failure modes either during switching OFF the power or restarting the device without checking the number of indication lamp blinking. Remote controller can redisplay up to last 5 failure modes from the memory. However, failure modes which are rarely to occur are also stored in the memory which caused the numbers of failure more than 5. Thus, for some failure modes which are unable to retrieve because of remote controller limit to redisplay only 5 failure modes, it can be found by clearing up the memory first then recheck the memory content again during the visit at the customer place.




### < How to redisplay failure diagnosis >

1. Turn the circuit breaker OFF.
2. Set the remote controller to OFF condition, indicated by **OFF** on the display.
3. By pressing  (MODE) button on the remote controller, set to Cooling operation indicated by  (COOL).
4. Turn the circuit breaker ON.
5. Set the room temperature setting on the remote controller to 32°C by pressing the (TEMP  $\downarrow$  or  $\uparrow$ ) button.
6. Set the fan speed with the  (FAN SPEED) button according to the desired failure information. (Refer to the corresponding table below)


Fan Speed	Data
AUTO 	Newest
HI 	Second newest
MED 	Third newest
LOW 	Fourth newest
SILENT 	Oldest


7. While directing the remote controller towards the receiver of the indoor unit, press (TEMP  $\uparrow$ ) button and  (START/STOP) button simultaneously. (The remote controller perform signal transmission with the device.)
8. The device beeps [Pi-] to indicate that it has just received the signal to redisplay the failure mode.
9. Direct the remote controller towards the receiver of indoor unit (within 2 meters in front of indoor unit) and press the  (INFO) button. Wait for 2 seconds for signal transmission. An error code will be displayed on the remote controller display.

### < How to clear the troubleshooting data >

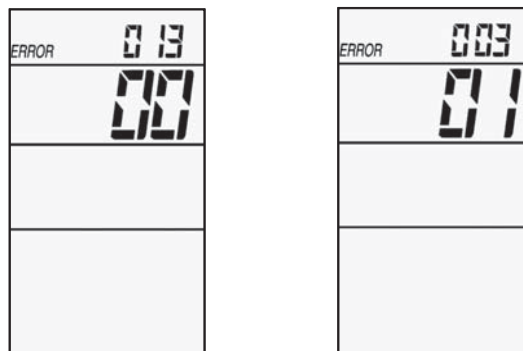
1. Redisplay the troubleshooting status. (See the above procedure.)
2. Turn the circuit breaker OFF.
3. By pressing  (MODE) button on the remote controller, set to Heating operation indicated by  (HEAT).
4. Turn the circuit breaker ON.
5. Set the room temperature setting on the remote controller to 16°C by pressing the (TEMP  $\downarrow$  or  $\uparrow$ ) button.
6. While directing the remote controller towards the receiver of the indoor unit, press (TEMP  $\downarrow$ ) button and  (START/STOP) button simultaneously. (The remote controller perform signal transmission with the device.)
7. The product beeps for a second [Pi-] to indicate that it has just received the signal. The data has now been cleared.

### < How to display error code in case of failure just occurs >

If timer lamp  of the indoor unit blinking and operation stops, please perform below procedures.

1. Direct the remote controller towards the receiver of indoor unit (within 2m in front of the indoor unit) and press  (INFO) button.
2. Wait for 2 seconds for signal transmission.
3. Indication of error code will be shown on the remote controller display for 10 seconds.

For example :



For details information regarding error code, please refer to page 69 .

	TIMER LAMP BLINKING	LD301 BLINKING	CODE	MEANING	DETAILS	MAIN CHECK POINT
INDOOR	-	-	000 00	Normal		
	1 time	-	001 00	Refrigerant cycle fault	When the indoor heat exchanger temperature is too low in the heating mode or it is too high in the cooling mode.	1. Reversing valve defective 2. Heat exchanger thermistor disconnected. (only in heating mode)
	2 times	-	-	Outdoor unit is under forced operation.	It is not failure. Outdoor unit is in forced operation or balancing operation after forced operation.	1. Electrical parts in the outdoor unit.
	3 times	9 times (single only)	003 00	Communication error between indoor and outdoor units.	Indoor interface circuit broken	1. Indoor interface circuit
	9 times	-	009 00	Indoor thermistor		
	10 times	-	010 00	Abnormal rotating numbers of DC fan motor	Overcurrent is detected at the DC fan motor of the indoor unit.	1. Indoor interface circuit 2. Outdoor interface circuit 3. Indoor control P.W.B
	12 times	9 times (single only)	012 00	communication error between indoor and outdoor units	Outdoor interface circuit broken	1. Outdoor interface circuit
	13 times	-	013 00	IC401 data reading error	When data read from IC401 or IC402 is incorrect.	1. IC401 or IC402 abnormal
	20 times	-	020 00	ECO sensor unit defective	Short- circuit	ECO sensor circuit

< Cautions >

This function is effective only once immediately after the power is turned on. It will not work if you have performed another remote control operation beforehand. Note also that it may not function in response to a procedure other than the above. (If it does not work, turn off the power, turn it back on and repeat the procedure.)

If the memory stores nothing, performing a redisplay operation will not blink the lamp.

For a normal operation, turn off the power and turn it back on. After the above operation, the product will not receive a remote control signal normally.

After clearing the troubleshooting data, turn off the power. (If you do not turn off the power, the product will become unresponsive to remote control signals.)

## Forced cooling operation (Only single connection)

The cooling operation can be forcibly performed for collecting refrigerant and inspecting failures. Do not perform the forced cooling operation continuously for long hours, because the compressor continues to be in operational status, regardless of room temperature.

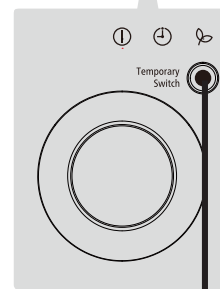
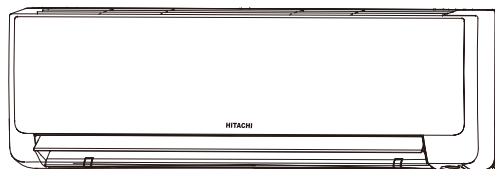
<How to start the operation>

- The operation of the unit should be stopped.
- Press and hold the "Temporary operation SW" shown in the right figure for 5 sec.

<How to stop the operation>

- Press and hold the "Temporary operation SW" again. Or stop the operation using the remote controller.

※During the forced cooling operation, the "Timer indicator" blinks twice.



### Temporary operation switch

When performing the forced cooling operation, turn the power off once. If you press and hold the switch for 5 sec or longer, the forced cooling operation starts. To stop the forced cooling operation, press the switch once again or stop the operation using the remote controller.

# HOW TO CHANGE THE SHIFT VALUE SETTING TEMPERATURE

The shift value setting temperature for Cooling and Heating mode operation can be change using remote controller. (This procedure shall be implemented strictly by service personnel only.)

(For initial shift value temperature setting for Cooling mode (SHIFTC) and Heating operation mode (SHIFTW) : Please refer to page 37 and page 38)

**PROCEDURES**

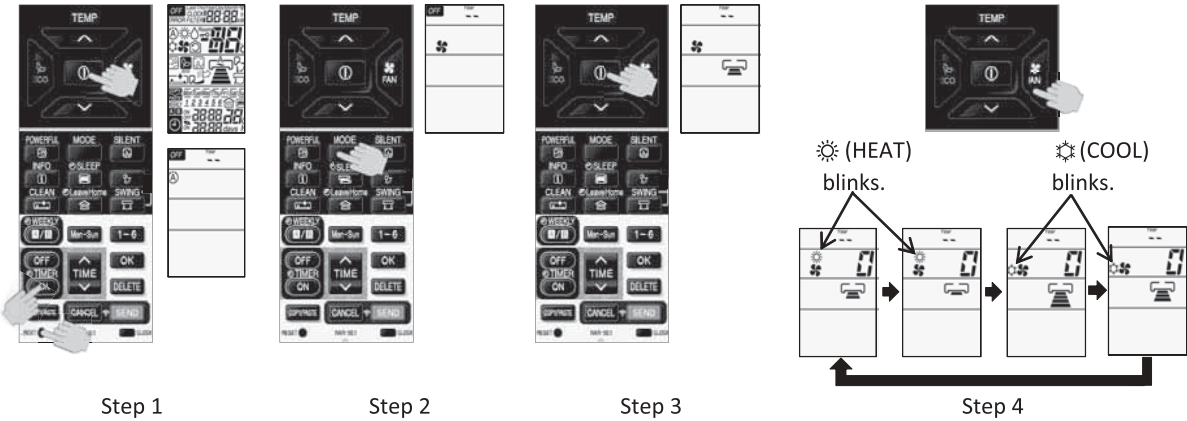
1. While pressing and holding (START/STOP) button and (ON) button, press [RESET] button on the same. Release [RESET] button only and make sure that all marks on the remote controller display are indicated, then release the (START/STOP) button and [ON] button. Remote controller now enters "Shift Value Change Mode".

2. Press the (MODE) selector button so that the display indicates (FAN) mode.

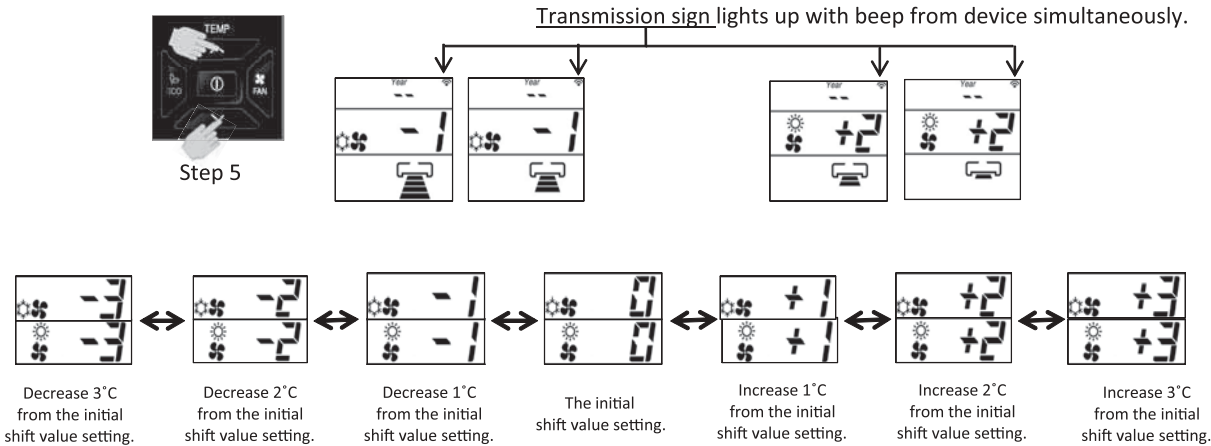
3. Press the (START/STOP) button and FAN operation will be started.

4. Set the FAN SPEED with the (FAN SPEED) button according to the following FAN speed setting in order to choose the desired operation mode that is required for shift value setting temperature modification.

- To change the shift value for COOLING mode operation, select either (HIGH) or (MED) FAN SPEED.
- To change the shift value for HEATING mode operation, select either (LOW) or (SILENT) FAN SPEED.



5. Press the (TEMP  $\vee$  or  $\wedge$ ) button to change the shift value. (The shift value changed with device beep sound.)



- NOTE :**
- (1) The displayed shift value, (HEAT) and (COOL) symbol on the remote controller display will be disappear after 10 seconds.
  - (2) The changed shift value will remain unchanged after turned off the power.
  - (3) If "0" is displayed on the remote controller display, it indicates the shift value is now at the initial setting.

## SETTING THE PREVENTION OF MUTUAL INTERFERENCE FOR REMOTE CONTROLLER

( Applicable for Remote controller model : RAR-6N1, RAR-6N2, RAR-6N3, RAR-6N4, RAR-6N5 )

Case : 2 sets of indoor units installed near to each other.

If both indoor units can receive the same remote controller signal, please set the remote controller as below. ( This setting will change the signal address of each remote controller.)

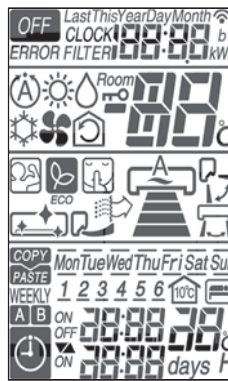
Initial remote controller signal address setting is **A**.

This procedure change the remote controller signal address from **A** to **B**.

1. The circuit breaker for the other unit shall be OFF.



2. Slide the remote controller cover to take it off.  
 3. While directing the remote controller towards the receiver of the indoor unit, press 1-6 button, ON (ON TIMER) button and RESET ○ (RESET) button simultaneously. (The remote controller perform signal transmission with the device.)



Signal transmission : From A to B



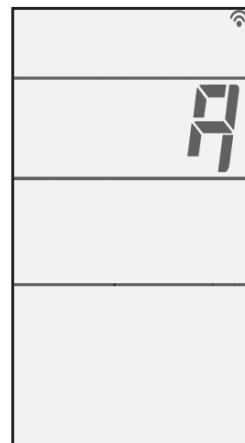
4. The indoor unit beeps [Pip] to indicate that it has just received the signal from remote controller.



5. Please check the usability of each set of indoor unit using its own remote controller.

Note : If indoor unit still not receive the correct signal from the correct remote controller, setting shall be made again.  
 By setting again for the 2nd time, the signal address will change from **B** to **A**. Then, if repeat again for the 3rd time, the remote controller signal address will change from **A** to **B**.  
 Please set the DIP switch No.6 to ON accordingly (Refer to page 57).

Signal transmission : From B to A









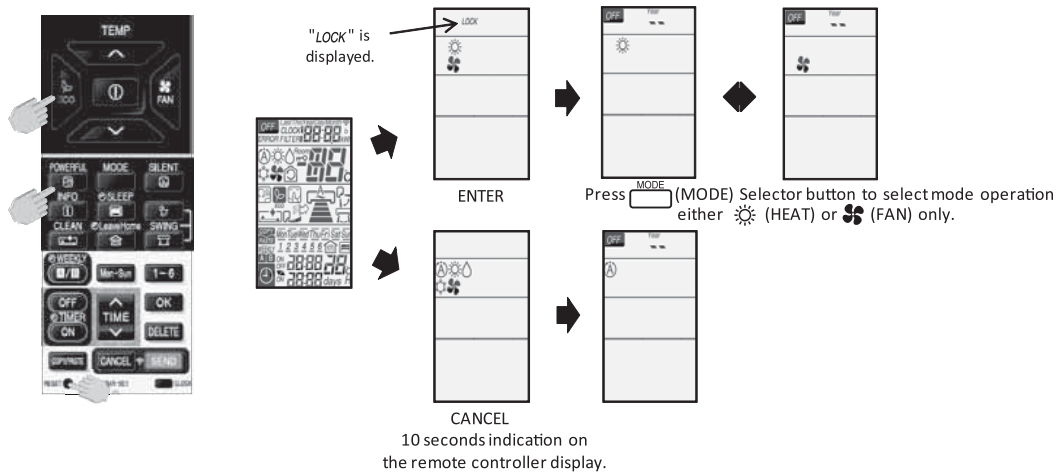
# OPERATION MODE LOCK SETTING

If Dip switch position is set at "Heating mode only" or "Cooling mode only" as mentioned on page 57, it is required to set the remote controller into operation mode lock setting. Without setting the remote controller, it will caused unmatch signal transmission between indoor unit and remote controller.







## PROCEDURE

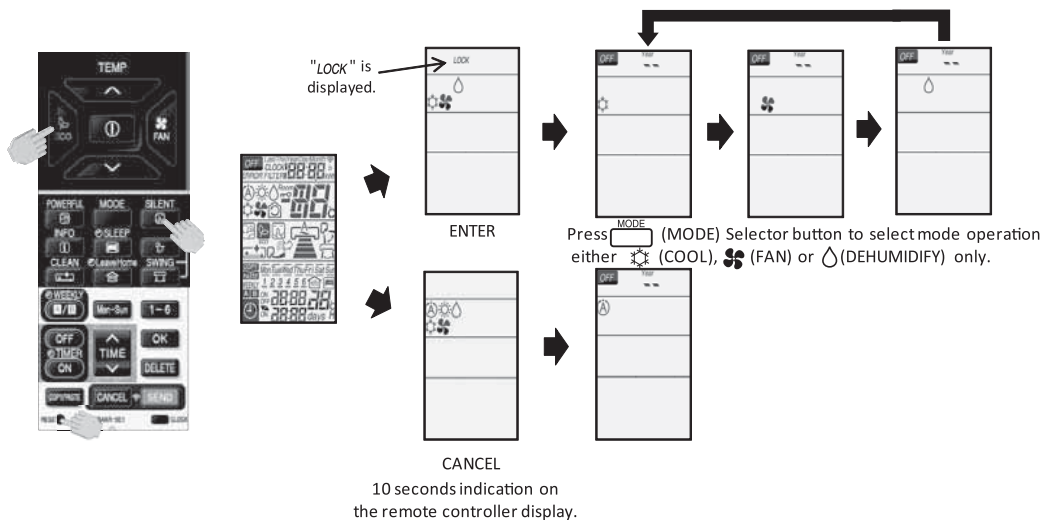
### 1. Heating operation mode lock setting

- (a) While pressing and holding  (ECO) button and  (POWERFUL) button, press  (RESET) button on the same time. Release  (RESET) button only and make sure that all marks on the remote controller display are indicated, then release the  (ECO) button and  (POWERFUL) button. Remote controller now enters "Heating operation mode lock".
- (b) To cancel the "Heating operation mode lock", repeat the above procedure (1(a)).







### 2. Cooling operation mode lock setting

- (a) While pressing and holding  (ECO) button and  (SILENT) button, press  (RESET) button on the same time. Release  (RESET) button only and make sure that all marks on the remote controller display are indicated, then release the  (ECO) button and  (SILENT) button. Remote controller now enters "Cooling operation mode lock".
- (b) To cancel the "Cooling operation mode lock", repeat the above procedure (2(a)).











## NOTE :

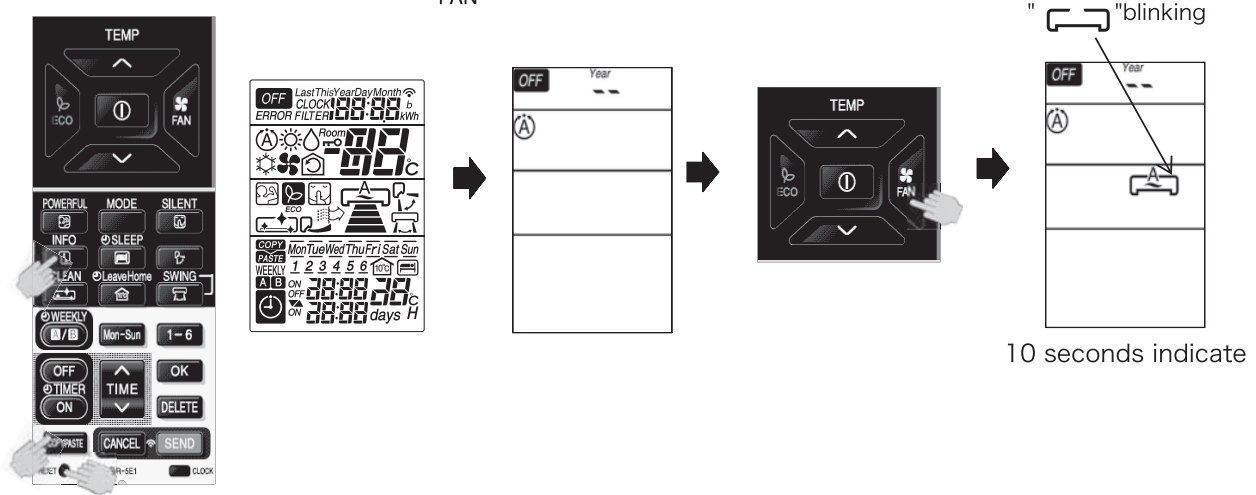
- (1) The indication of " LOCK " and ("" (HEAT), "" (COOL), "" (FAN) or "" (DEHUMIDIFY)) mode operation symbol on the remote controller display will disappear after 10 seconds, and it will enter to OFF condition indicated by **OFF** on the display.
- (2) The OPERATION MODE LOCK setting will remain in the remote controller memory even though the remote controller is ran out of battery.



# DISPLAY OPERATION MODE SETTING

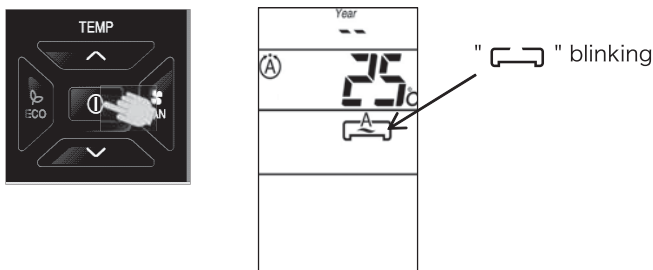
For operating indoor unit independently (without outdoor unit connection), remote controller has to be set according to below procedures before send the signal to the indoor unit. New communication format between indoor and outdoor is required to communicate with outdoor unit.

## PROCEDURE

- While pressing and holding  (INFO) button and  (COPY/PASTE) button, press  (RESET) button on the same time. Release  (RESET) button only and make sure that all marks on the LCD display are indicated, then release the  (INFO) button and  (COPY/PASTE) button. Remote controller now enters "DISPLAY OPERATION MODE" for the indoor unit to run independently. Please ensure that when pressing  (FAN) button, "" will blinking.



- Press the  (MODE) selector button to choose the desired operation mode.
- Press  (START/STOP) button. Then, the indoor unit will starts to operate independently accoring the selected operation mode.






## NOTE :




- (1) During "DISPLAY OPERATION MODE", " blinks on LCD of remote controller.
- (2) When operation stops, "DISPLAY OPERATION MODE" is canceled.

## HOW TO CHANGE THE INTERMITTENT FAN CONTROL SETTING

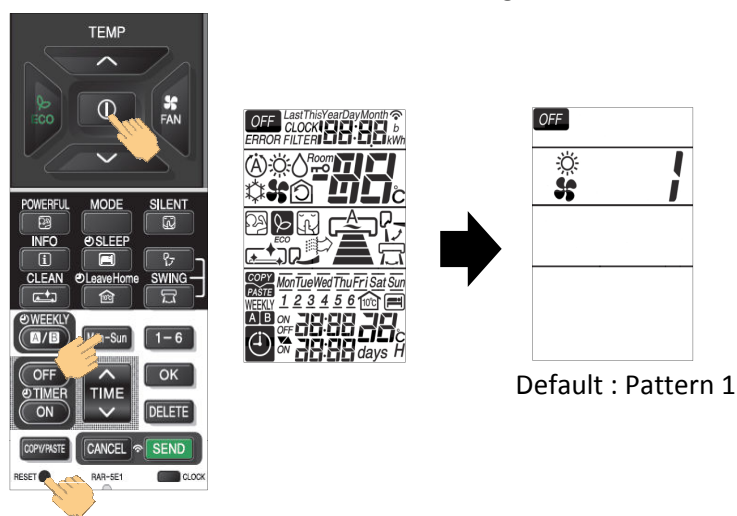
The intermittent fan control during thermo off in Heating mode can be changed by the remote controller. (This procedure should be done only by service personnel.)  
It is possible to select from 3 patterns.

### PROCEDURE

1. Press  [START/STOP] button,  [Mon-Sun] button and press  [RESET] button simultaneously.

Release  [RESET] button only and make sure that all marks on the remote controller display are indicated, then release  [START/STOP] button and  [Mon-Sun] button.

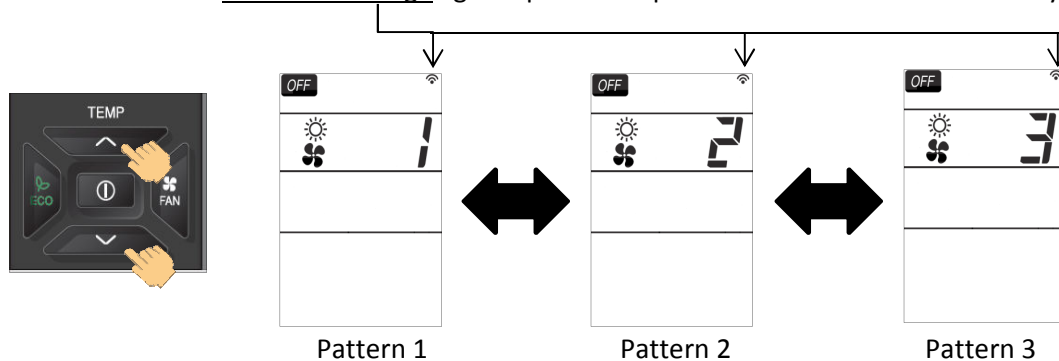
Remote controller now enters "Intermittent Fan Control Change Mode".



2. Press [ROOM TEMPERATURE setting] [ $\wedge$ (UP)]/[ $\vee$ (DOWN)] buttons.

(The intermittent pattern changed with indoor unit beep sound.)

Transmission sign lights up with beep from indoor unit simultaneously.



	Pattern 1	Pattern 2	Pattern 3
Single model	Continuous	30sec ON/210sec OFF repeatedly	50sec ON/190sec OFF repeatedly
Multi model	30sec ON/210sec OFF repeatedly	50sec ON/190sec OFF repeatedly	Continuous

### NOTE :

- (1) The indication of the selected intermittent pattern will disappear after 10 seconds.
- (2) The selected intermittent pattern will remain unchanged after the unit is turned off.



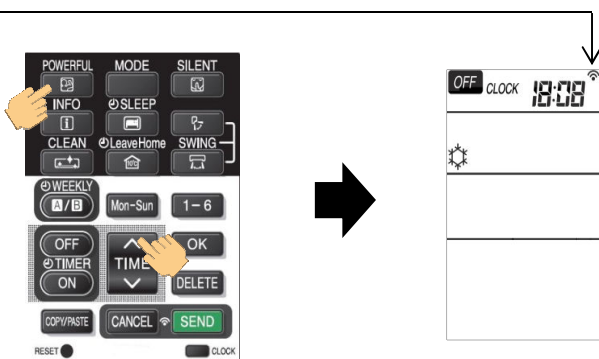
# HOW TO CHANGE THE FAN SPEED IN COOLING MODE DURING THERMO OFF

The fan speed in Cooling mode during thermo off can be changed by the remote controller.  
 (This procedure shall be implemented strictly by service personnel only.)  
 It is possible to return it to the default setting.

## PROCEDURE

Press **POWERFUL** [POWERFUL] button and **TIME** [TIME ^ (UP)] button simultaneously for about 5 seconds when the remote controller is OFF.

Transmission sign lights up with beep from indoor unit simultaneously.



- Beep sound pattern :
- 1) Default setting : Short beep
  - 2) Changed setting : Double beep

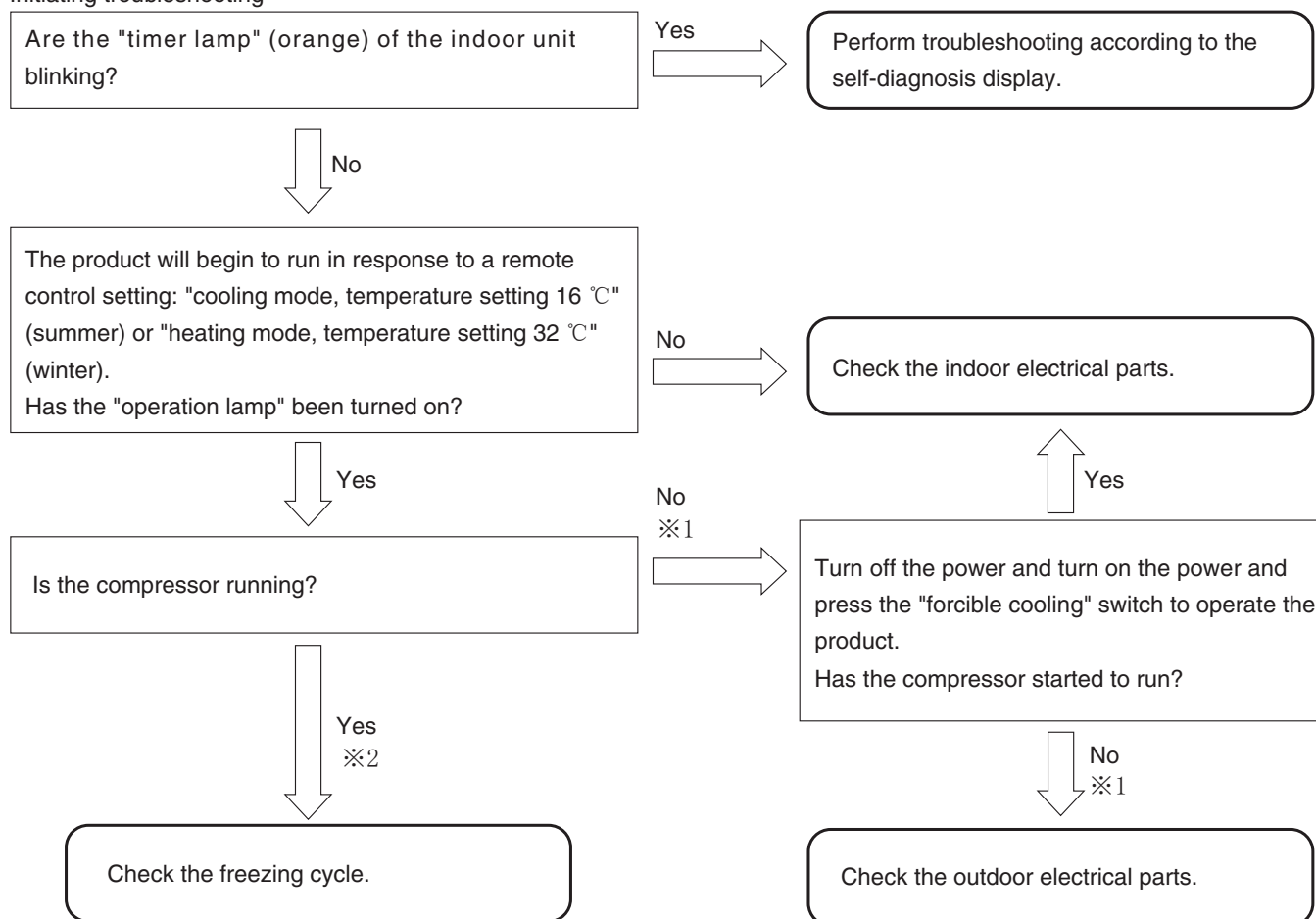
	Fan speed during thermo off
Default setting	Ultra low
Changed setting	Set fan speed (When auto fan speed is set, the fan speed is low.)

## NOTE :

- (1) The selected fan speed will remain unchanged after the unit is turned off.
- (2) If Timer reservation has been set, it will be canceled.
- (3) During time setting and timer setting, this operation cannot be set.

## Diagnosis and troubleshooting of indoor electric parts

### Initiating troubleshooting



### < Troubleshooting by using the self-diagnosis memory function >

- By using the self-diagnosis memory function, you can check the failure mode (※1) occurring in the outdoor electrical parts on the indoor unit side.

- Steps
1. Clear the troubleshooting data.
  2. Run the product for several minutes under the conditions where the compressor runs.
  3. Redisplay and check the data written in the self-diagnosis memory.

- The self-diagnosis memory function can also be used to catch sporadic failure phenomena.

- Steps
1. Clear the troubleshooting data.
  2. Have the user use the product as usual until a failure phenomenon occurs.  
(The period depends on the incidence of the phenomenon.)
  3. At a later date, redisplay and check the data written in the self-diagnosis memory.

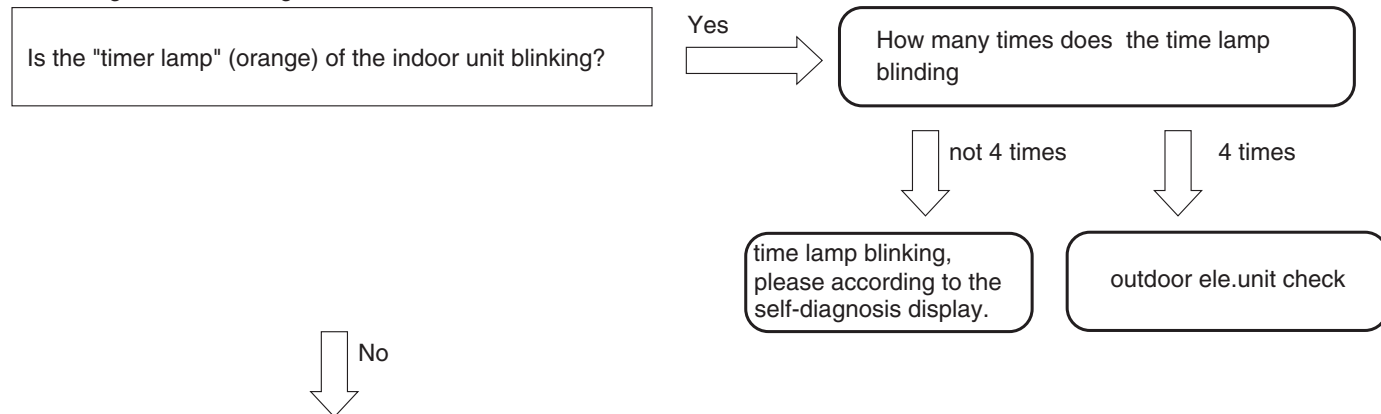
- For the outdoor self-diagnosis display (OH thermistor heat-up, overload lower limit cut) stemming from the freezing cycle or operating condition, the time lag is long from operation startup to the emergence of the phenomenon. Moreover, it is affected by the temperature, sunshine, operating hours, and other factors of the day, so that the phenomenon may not be able to be identified at the time of a repair service visit. In that case too, use the self-diagnosis memory function (※2).
- The outdoor self-diagnosis display "overload lower limit cut" and "OH thermistor heat-up" can be identified only when you are using the self-diagnosis lamp of the outdoor unit and the self-diagnosis memory function of the indoor unit. Note that this will not be automatically displayed on the indoor unit side.

## Checking the indoor unit electrical parts

### Introduction

First check the failure phenomenon and status, and then move on to elaborate diagnosis.

#### Initiating troubleshooting



Turn off the power, wait at least 5 seconds, turn it back on, and observe the way the horizontal vanes move for about 30 seconds.  
Check 1: Have the horizontal vanes moved? (Yes/No)

Set the remote control unit to cooling mode, temperature setting 16°C (summer), heating mode, temperature setting 32°C (winter) and operate the product.  
Check 2: Has the product received the remote control signal and has the "operation lamp" gone on? (Yes/No)

If you responded "Yes" to Check 2:  
Check 3: Is the compressor of the outdoor unit running? (Yes/No)

If you responded "No" to Check 2:  
Check 4: Does the "emergency operation switch" work? (Yes/No)

#### Check results and next check items

Check 1	Check 2	Check 3	Check 4	Next check item
No	No	—	No	Go on to "The power will not become turned on".
Yes	No	—	Yes	Go on to "The product will not receive the remote control signal".
Yes	Yes	No	—	Go on to "The compressor will not run".

# 1. Failure phenomenon: The power will not become turned on.

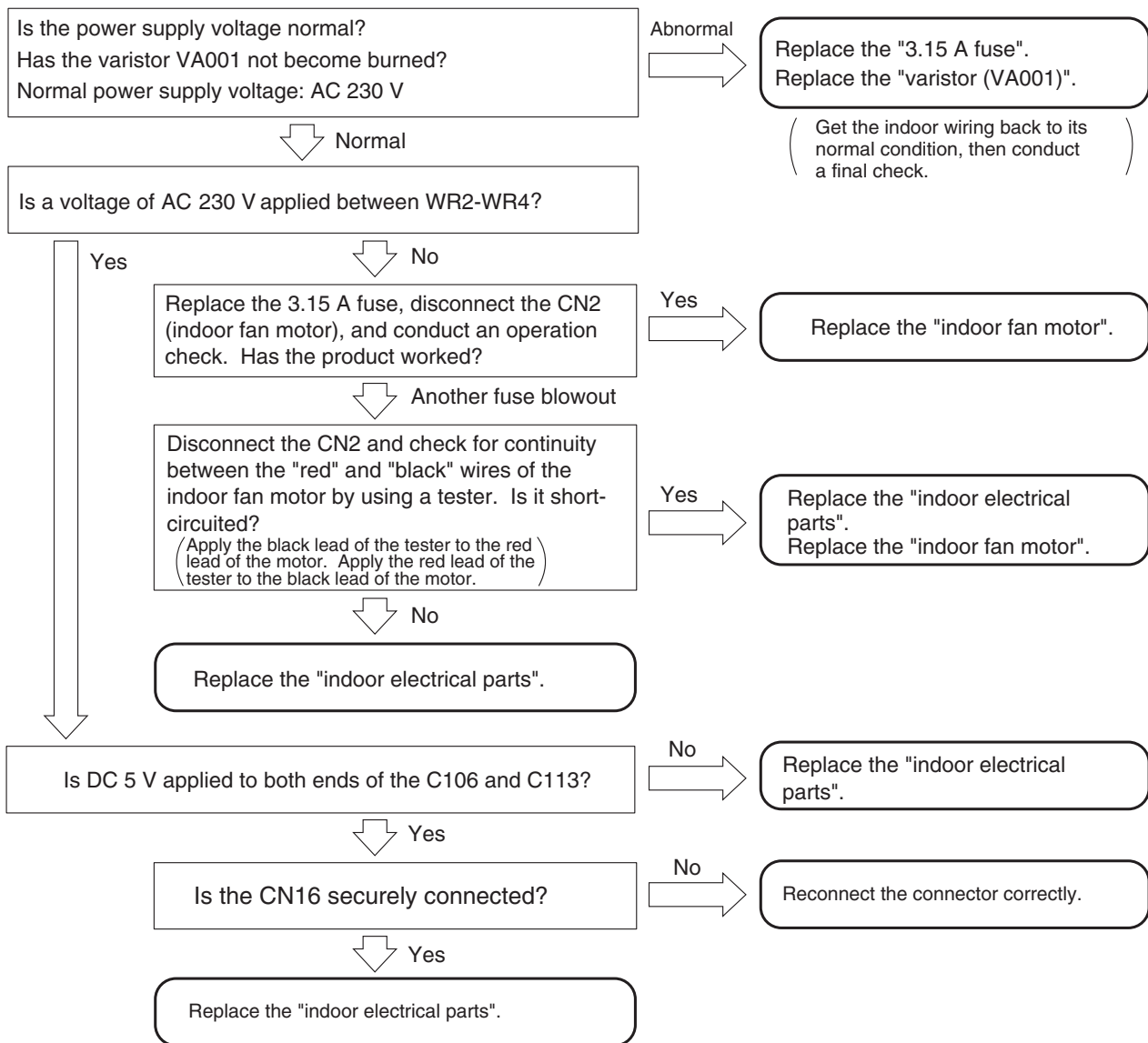
[Situation ] Neither initialization, remote control, nor any other step works on the vane position at power-on.

<p>[ Estimated failure locations ]</p> <ul style="list-style-type: none"> <li>· 3.15 A fuse blown out</li> <li>· Control power circuit</li> <li>· Connector loose, wire break</li> </ul>	<p>Estimated cause of fuse blowout</p> <ul style="list-style-type: none"> <li>· Abnormally high voltage applied to the power supply</li> <li>· Indoor fan motor out of order</li> <li>· Power circuit out of order</li> </ul>
--	---

- [Cautions ]
- Before work, check the power supply voltage. An abnormal voltage may be being supplied in some rare occasions due to a defect in the indoor wiring (a wire break in the neutral wire of the single-phase 3-wire power supply).
  - If the 3.15 A fuse has blown out, eliminate the cause of the fuse blowout. Otherwise, there will occur another fuse blowout.
  - If the 3.15 A fuse has blown out due to an abnormally high voltage to the power supply, the varistor (VA001) will deteriorate and become destroyed as well.
  - On a repair service visit due to the failure phenomenon of "The power will not become turned on", take a "3.15 A fuse" and a "varistor" with you.

## [Diagnosis flow ]

### Initiating troubleshooting

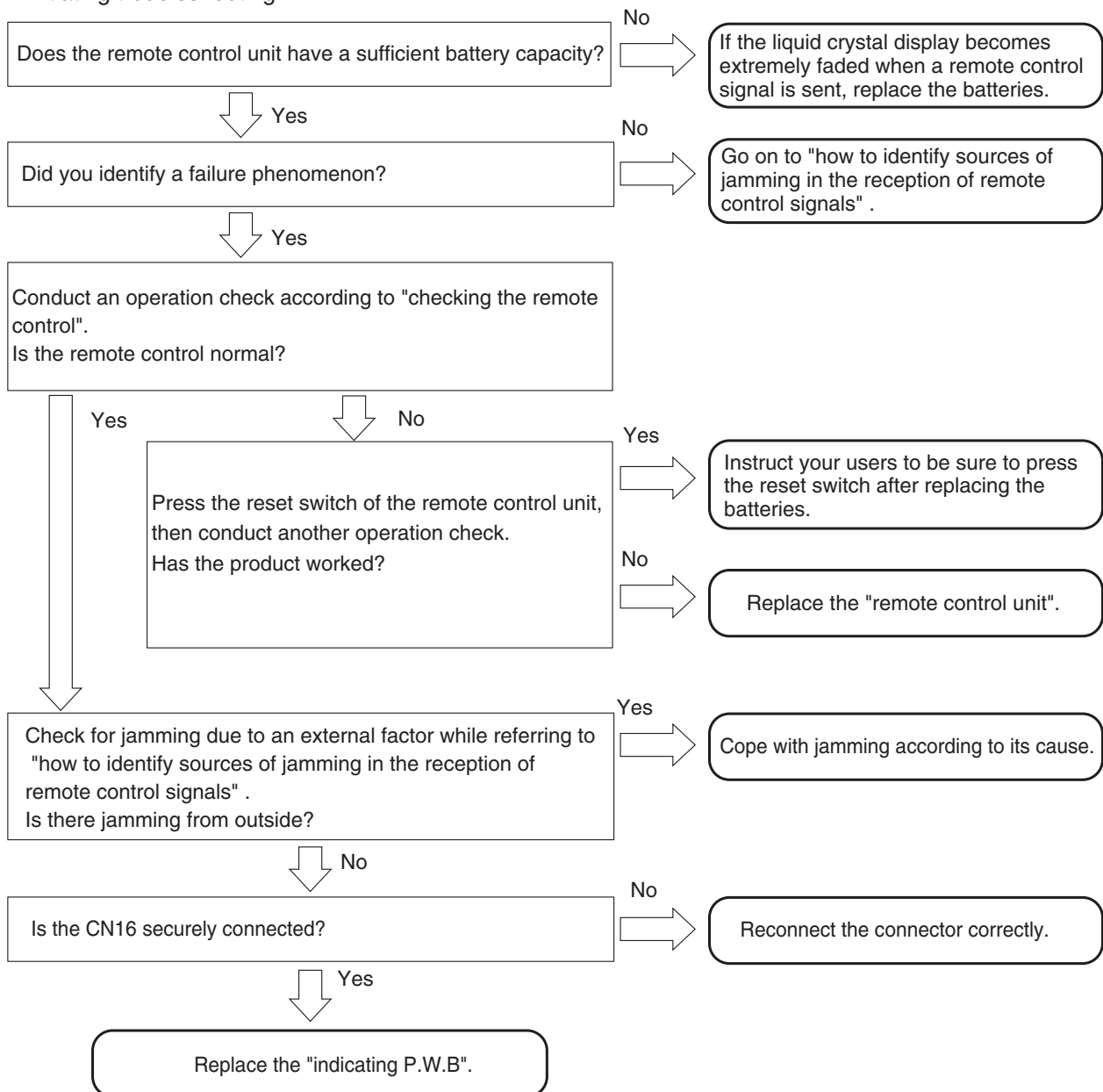


## 2.Failure phenomenon: The product will not receive a remote control signal.

- [Situation ] The product does not receive a remote control signal. It is not very responsive.  
(The product does run normally in response to the emergency operation switch.)
- [Estimated failure locations ]
- Remote control failure, remote control low battery level, remote control poorly set
  - Remote control light-receiving unit
  - Connector loose, wire break
  - Normal product (external factors: the remote control units for lighting equipment and other equipment, electrical noise, etc.)
- [Cautions ]
- Even if the product is trouble-free, a factor coming from outside the product may hamper the reception of signals from the remote control unit.
  - Batteries may decline in capacity at low temperatures. Old batteries decline particularly much in voltage in the morning and evening of winter, resulting in the poor arrival of remote control signals. Instruct your users to use new alkaline batteries.

### [Diagnosis flow ]

#### Initiating troubleshooting



[Cautions in replacing the indicating P.W.B] Be sure to replace the indicating P.W.B. components.

## How to identify sources of jamming in the reception of remote control signals

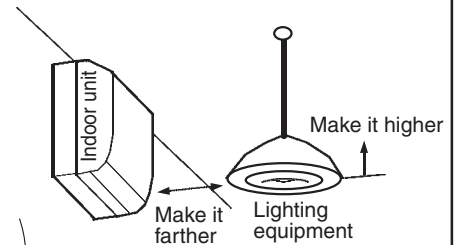
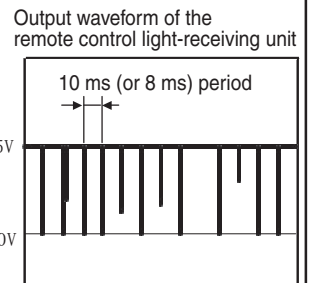
[ Situation ] The product may become poorly responsive to remote control signals due to external factors even though the product itself is trouble-free.

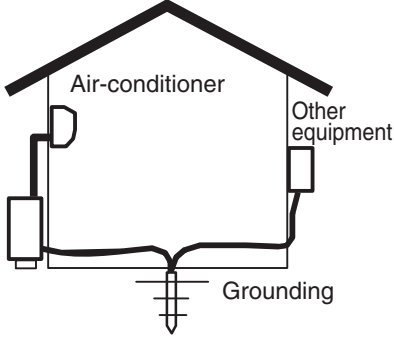
[ Estimating sources of jamming ] Identify the installation status of the air-conditioner and the indoor and outdoor environments to identify possible causes of the jamming.

- Indoor lighting equipment (quantity, type, location)
- Remote control units of other electrical products and equipment
- Is the grounding for the air-conditioner shared with other equipment?
- Are the surroundings of the air-conditioner clear of wireless antenna?
- Is the remote control light-receiving unit protected from direct sunlight?

[ Checking and actions ]

<p>Effects of lighting equipment (fluorescent lamps)</p>	<p><u>Checking points</u></p> <ul style="list-style-type: none"> <li>· Turn on and off the lighting equipment and check for its effects on the reception of remote control signals.</li> <li>· When cold, the fluorescent lamp tends to emit infrared rays with wavelengths close to those used in remote control.</li> </ul> <p>If you cannot detect the phenomenon about which your user is complaining at the time of your visit, such as "the product sometimes fails to receive remote control signals" and "the product fails to receive remote control signals in the morning alone", then turn off the lighting for about 20-30 minutes and wait for the fluorescent lamps to cool down before conducting another check.</p> <p>There are even cases where the product fails to receive remote control signals for 1 to 2 minutes only after the lighting equipment is turned on.</p> <ul style="list-style-type: none"> <li>· The noise status may vary with the dimming of the lighting equipment. In the case of lighting equipment with a dimmer, therefore, conduct a check with all the light intensities.</li> <li>· If the lighting equipment is the source of the jamming, the remote control light-receiving unit output usually shows a noise waveform as shown in the right-hand figure. In the case of slight jamming, this kind of waveform will not cause practical problems. However, intense degrees of jamming will disable the reception of remote control signals.</li> <li>· When the fluorescent lamp is old and is flickering, it may cause disorders in the reception of remote control signals.</li> </ul> <p><u>Actions proposed</u></p> <ol style="list-style-type: none"> <li>1. Make it hard for light of the lighting equipment to enter the remote control light-receiving unit. <ul style="list-style-type: none"> <li>· Separate the lighting equipment from the indoor unit.</li> <li>· Raise the lighting equipment.</li> <li>· Cover the upper half of the light-receiving panel from its rear side with aluminum tape or black vinyl tape.</li> </ul> <p>( This will also affect the reception of remote control signals. Therefore, set the range to be covered with tape to a range that is problem-free in practice, while checking the reception status. )</p> </li> <li>2. Add an interference filter to the front panel of the remote control light-receiving unit. <ul style="list-style-type: none"> <li>※ Lighting equipment that produces strong jamming exists although rarely. Some problems may therefore be unsolvable by managing the air-conditioner side alone.</li> </ul> </li> </ol>
<p>Effects of the remote control units of other equipment</p>	<p><u>Checking points</u></p> <ul style="list-style-type: none"> <li>· If, on the remote control unit of a TV or audio equipment, its sound volume key or something similar is left pressed, infrared signals become continuously sent, thereby jamming the reception of remote control signals.</li> <li>· Check how the remote control unit and related components are stored, thereby checking if there is any possibility that a button may be inadvertently left pressed on the remote control unit of other equipment.</li> </ul> <p><u>Actions proposed</u></p> <p>If there is any such possibility, give explanations to your users to that effect and instruct them to exercise caution.</p>



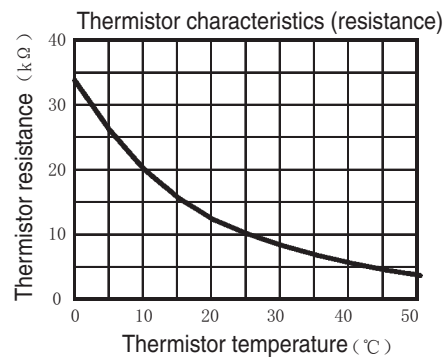
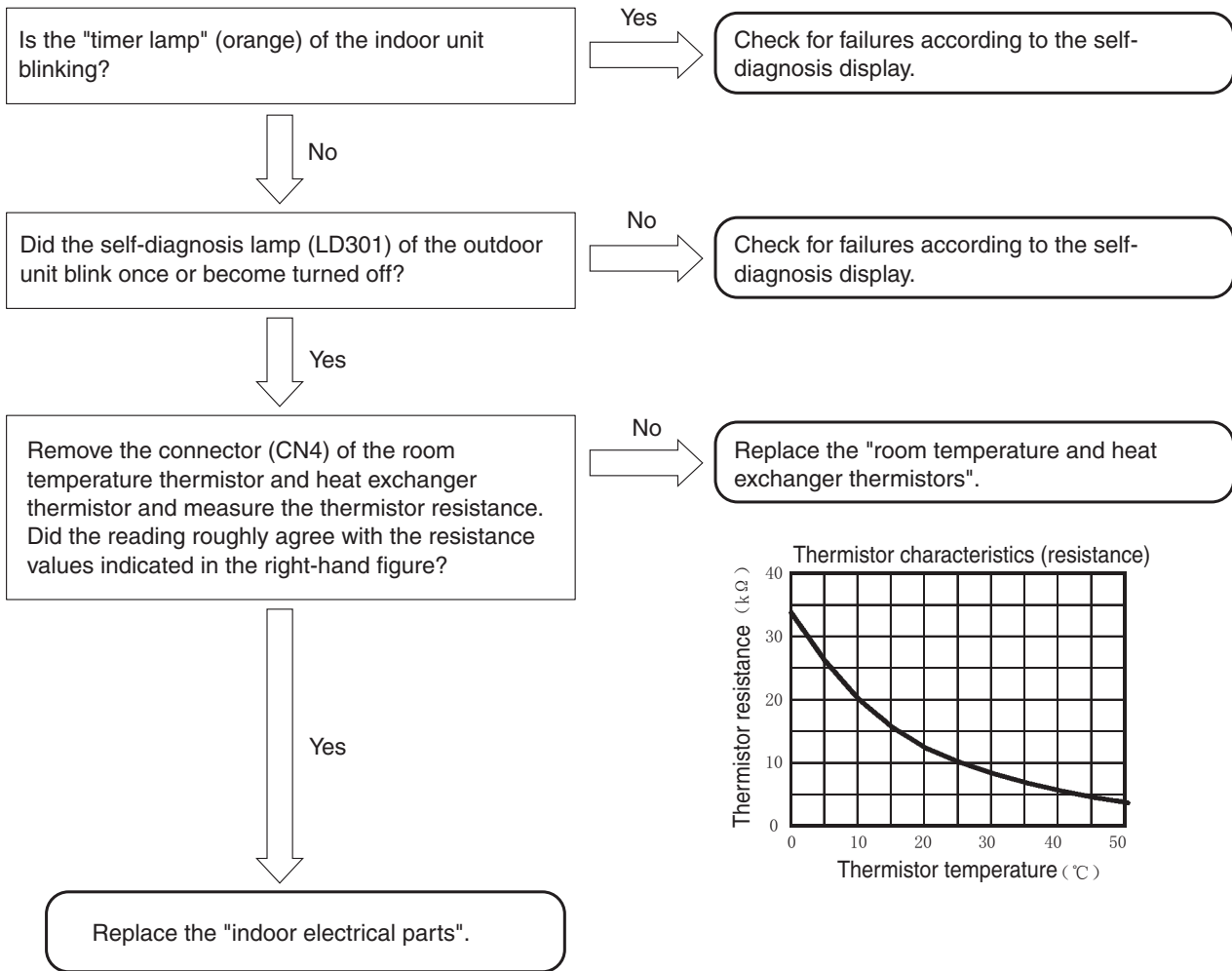
<p>Effects of other electrical products</p>	<p><u>Checking points</u></p> <ul style="list-style-type: none"> <li>· Check the effects of light and power noises coming from other electrical products.</li> <li>· Turn on and off the electrical products, turn off the power and turn on the power, and check their effects on the reception of remote control signals.</li> <li>· For products whose operating states change, check the effects of each state.</li> </ul> <p><u>Actions proposed</u></p> <ul style="list-style-type: none"> <li>· Change the location relationship between the air-conditioner and the target products.</li> <li>· Use a different wall outlet for the target products.</li> </ul>
<p>Sharing a grounding</p>	<p><u>Checking points</u></p> <ul style="list-style-type: none"> <li>· Check for effects of electrical noises coming into the air-conditioner through grounding wires.</li> <li>· Check if the grounding works is for the air-conditioner alone or shared with other equipment. If there is any equipment that shares it, turn on and off that equipment and detach and reattach the power plugs and examine their effects on the reception of remote control signals.</li> </ul> <p><u>Actions proposed</u></p> <ul style="list-style-type: none"> <li>· Establish an independent grounding for the air-conditioner.</li> </ul>  <p>The diagram shows a cross-section of a house with a gabled roof. An 'Air-conditioner' is mounted on the left wall, and 'Other equipment' is on the right wall. Both are connected to a single horizontal line representing a shared grounding system. This line leads to a vertical line labeled 'Grounding' which is connected to a ground symbol (three horizontal lines of decreasing width) at the bottom center.</p>
<p>Effects of radio waves</p>	<p><u>Checking points</u></p> <ul style="list-style-type: none"> <li>· Using a wireless transmitter near the air-conditioner may affect the reception of remote control signals.</li> <li>· Have your users try sending signals with a wireless transmitter and examine their effects on the reception of remote control signals.</li> </ul> <p><u>Actions proposed</u></p> <ul style="list-style-type: none"> <li>· Add a ferrite core to the power cord and F cable.</li> <li>· Add a ferrite core to the internal wiring of the indoor unit.</li> <li>· Move the wireless antenna.</li> </ul>
<p>Effects of direct sunlight</p>	<p><u>Checking points</u></p> <ul style="list-style-type: none"> <li>· Direct sunlight and other intense light make the remote control light-receiving unit less sensitive.</li> <li>· Check for any time zone where the remote control light-receiving unit of the indoor unit is affected by direct sunlight depending on the location of the sun and mirror reflection.</li> </ul> <p><u>Actions proposed</u></p> <ul style="list-style-type: none"> <li>· Block the sunlight to protect against direct sunlight.</li> </ul>

### 3. Failure phenomenon: The compressor will not run.

[ Situation ] The compressor will not run (the same state as the thermometer turned off), the product receives remote control signals normally. The self-diagnosis lamp (LD301) of the outdoor unit blinks once or becomes turned off.

[ Estimated failure locations ] · Room temperature thermistor, heat exchanger thermistor  
· Microcomputer peripheral circuit

[ Diagnosis flow ]  
Initiating troubleshooting





#### 4. Failure phenomenon: The fan motor will not stop.

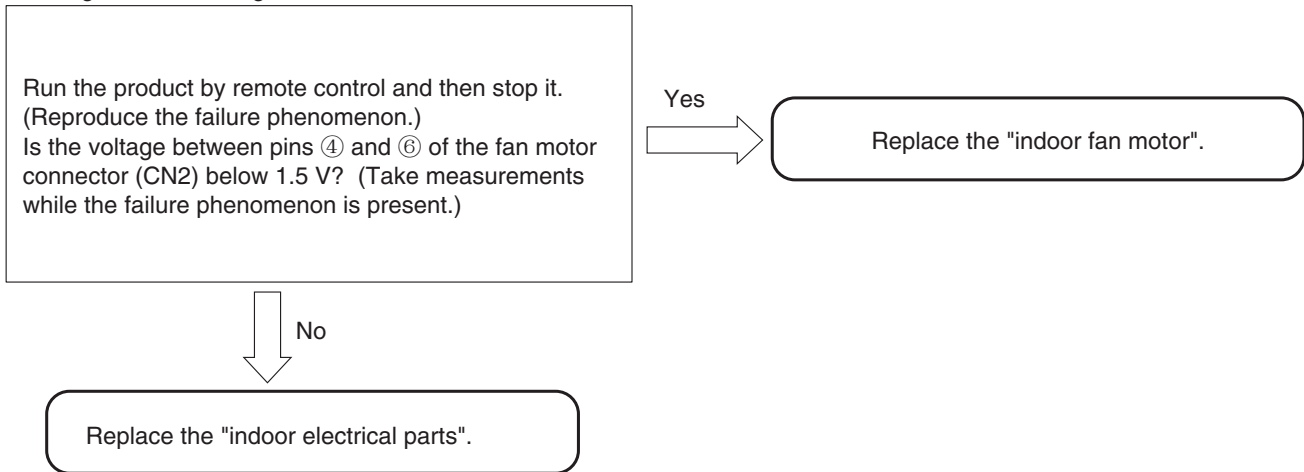
[Situation ] I have conducted the stop operation on the product by remote control, but the indoor fan motor will not stop.  
(It stopped about 10 minutes later.)

[Estimated failure locations ]

- Indoor fan motor
- Fan motor drive circuit

[Diagnosis flow ]

Initiating troubleshooting



## 5.Failure phenomenon:The eco sensor lamp is blinking(on for 4 seconds,off for 1 second)

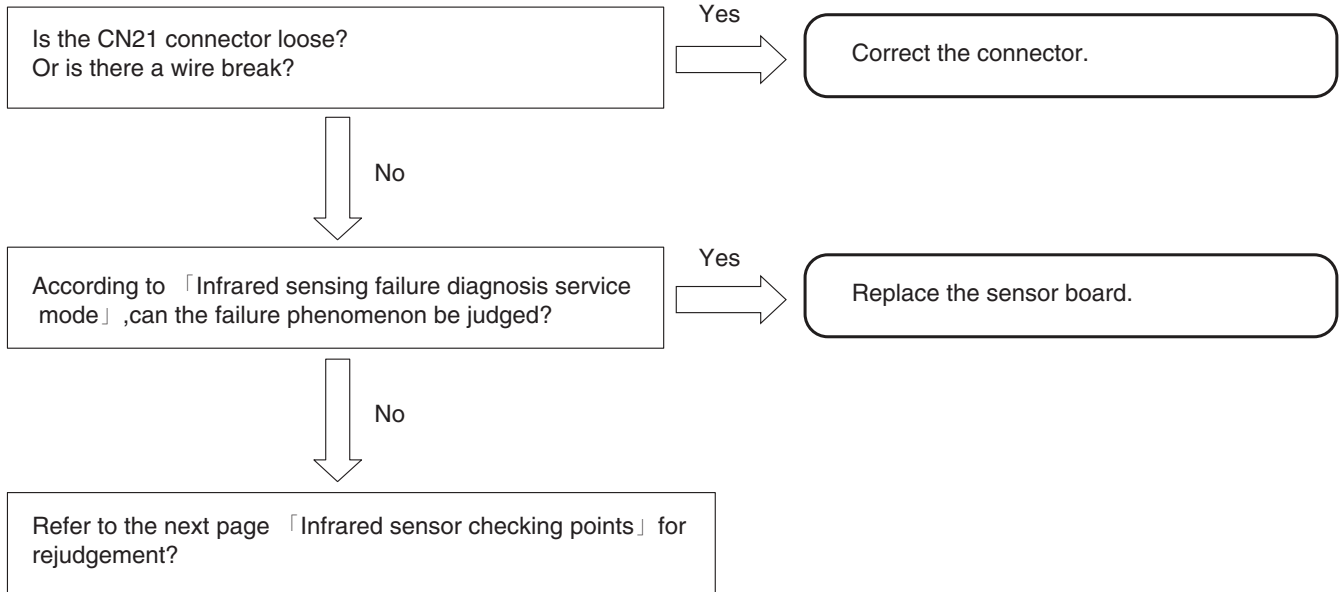
<Situation> The eco sensor lamp is blinking(on for 4 seconds,off for 1 second)  
 The infrared human presence sensing function can not be in operation or the sense is blunt.  
 「Timer lamp is blinking for 20 times」 is kept in self-diagnosis memory function.

<Estimated failure locations>   • The sensor board break.  
   • CN21 connector loose,lead wire break.

<Cautions> After pressing the 「eco sensor」 buttons by remote controller,the infrared human presence sensing mode is set.The infrared sensor self-diagnosis usually works 1 minute at least to 1 hour at most to diagnose.Please refer to 「Infrared sensing failure diagnosis service mode」.

<Diagnosis flow>

Initiating troubleshooting



### Human infrared sensor checking points

If already used the self-diagnosis way to check out there is no fault but low sensitivity,false action is also occur , please check as follows

#### Structure confirm

- Is the structure and appearance of fresnel lens ok? Please confirm whether there any dirt or nick on it  
Please confirm whether fresnel lens is loose
- Does the structure of the sensor P.W.B have any problem?

#### Note

- ※ The infrared sensor detects changes to infrared generated by human bodies ,if there is dirt or nick on the surface of the Fresnel lens,it will distube the detection of the infrared sensor.
- ※ If the assembly position is incorrect,the area detected will be incorrect so that it will distube the operation of the dynamic air deflection function.

#### The surround environment confirm

The infrared sensor detects changes to the infrared generated by human bodies,therefore ,the accuracy of infrared sensor may be affected in the following cases:

- The actibity level is very low or human bodies are locked by a screen, cabinet,or glass board.
- the indoor temperature is very high and exceeds or approaches the human body temperature (when the refrigeration just begins).
- The person wears thick clothes and turns his/her back to the air conditioner.
- curtains or plant leaves swing due to pet movement oe airflow.

## 6. Timer lamp blinking: blinking once

[Situation] The timer lamp blinks one time and the product will not operate.  
(This is not a sign of a breakdown.)

[Estimated failure locations] · Reversing valve defective.  
· The refrigerating cycle block gas leak.

## 7. Timer lamp blinking: blinking twice

[Situation] The product is giving a display to indicate that it is performing forcible cooling.  
(This is not a sign of a breakdown.)

## 8. Timer lamp blinking: blinking three times

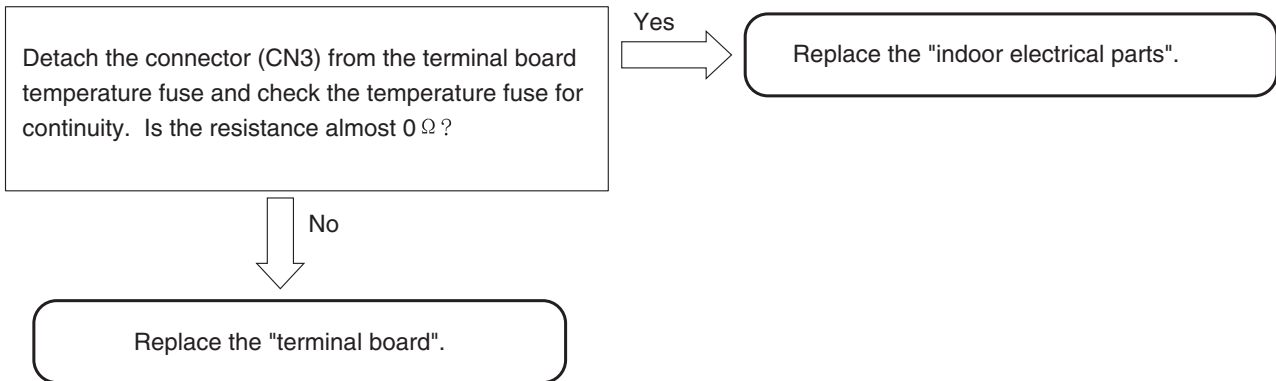
[Situation] The timer lamp blinks three times and the product will not operate.

[Estimated failure locations] · Meltdown of the terminal board temperature fuse (the terminal board poorly inserted into the F cable)  
· Outdoor communication circuit out of order

[Cautions] · If a terminal board is replaced to counter the meltdown of the terminal board temperature fuse, ensure that the F cable to be inserted into the terminal board has the appropriate dimension for peeling the insulation sheathing and that the insertion region is unbent before inserting it into the terminal board securely.

[Diagnosis flow]

Initiating troubleshooting



## 9. Timer lamp blinking: blinking four times

[Situation] The timer lamp blinks four times and the product will not operate.

[Estimated failure locations] · Outdoor unit error.  
· Please confirm the times of the LD301 blinking, and then see the outdoor selfcheck table.

## 10 . Timer lamp blinking: blinking 9 times

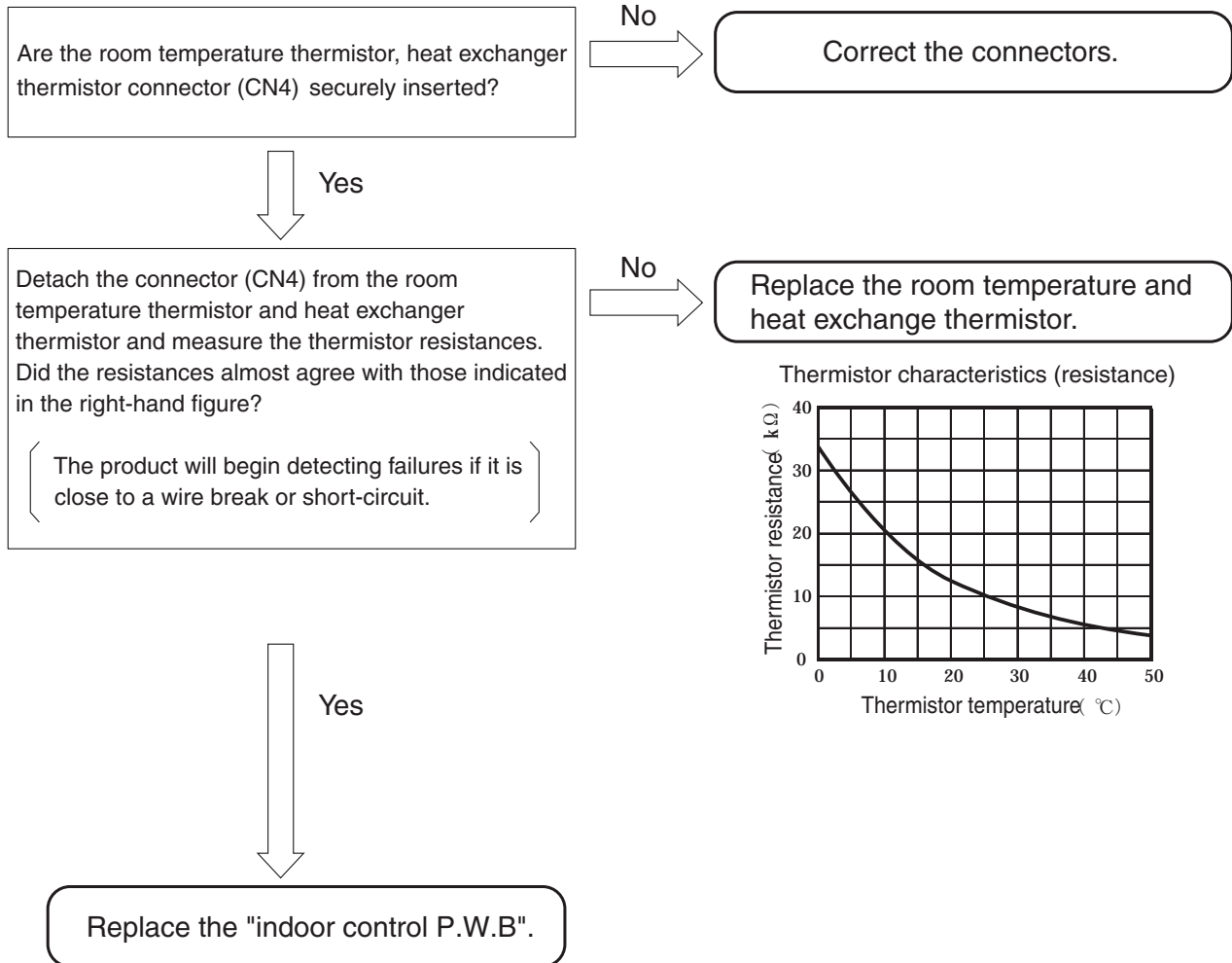
[Situation] The timer lamp blinks 9 times and the product will not run.

[Estimated failure location] • Loose connector, wire break, or short-circuit in the room temperature thermistor, heat exchanger thermistor.

[Cautions] • Starting the product by remote control will initiate failure detection.  
(Merely turning on the power will not activate the failure detection function.)

### [Diagnosis flow]

#### Initiating troubleshooting



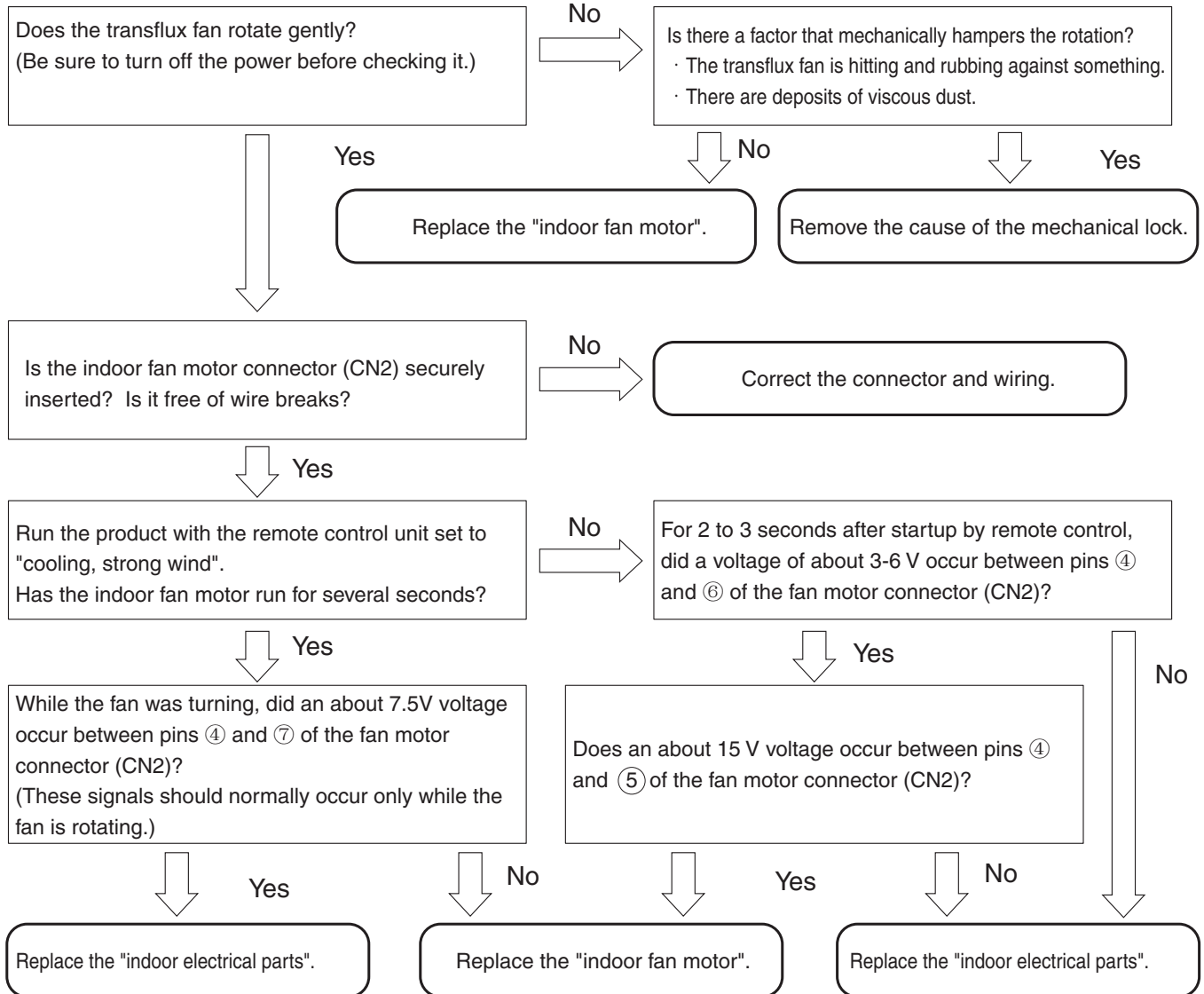
## 11. Timer lamp blinking: blinking 10 times

[Situation] The timer lamp blinks 10 times and the product will not run.

- [Estimated failure locations]
- Loose connector or wire break in the indoor fan motor
  - Indoor fan motor mechanically locked
  - Indoor fan motor
  - Indoor fan motor drive circuit

[Diagnosis flow]

Initiating troubleshooting



## 12. Timer lamp blinking: blinking 12 times

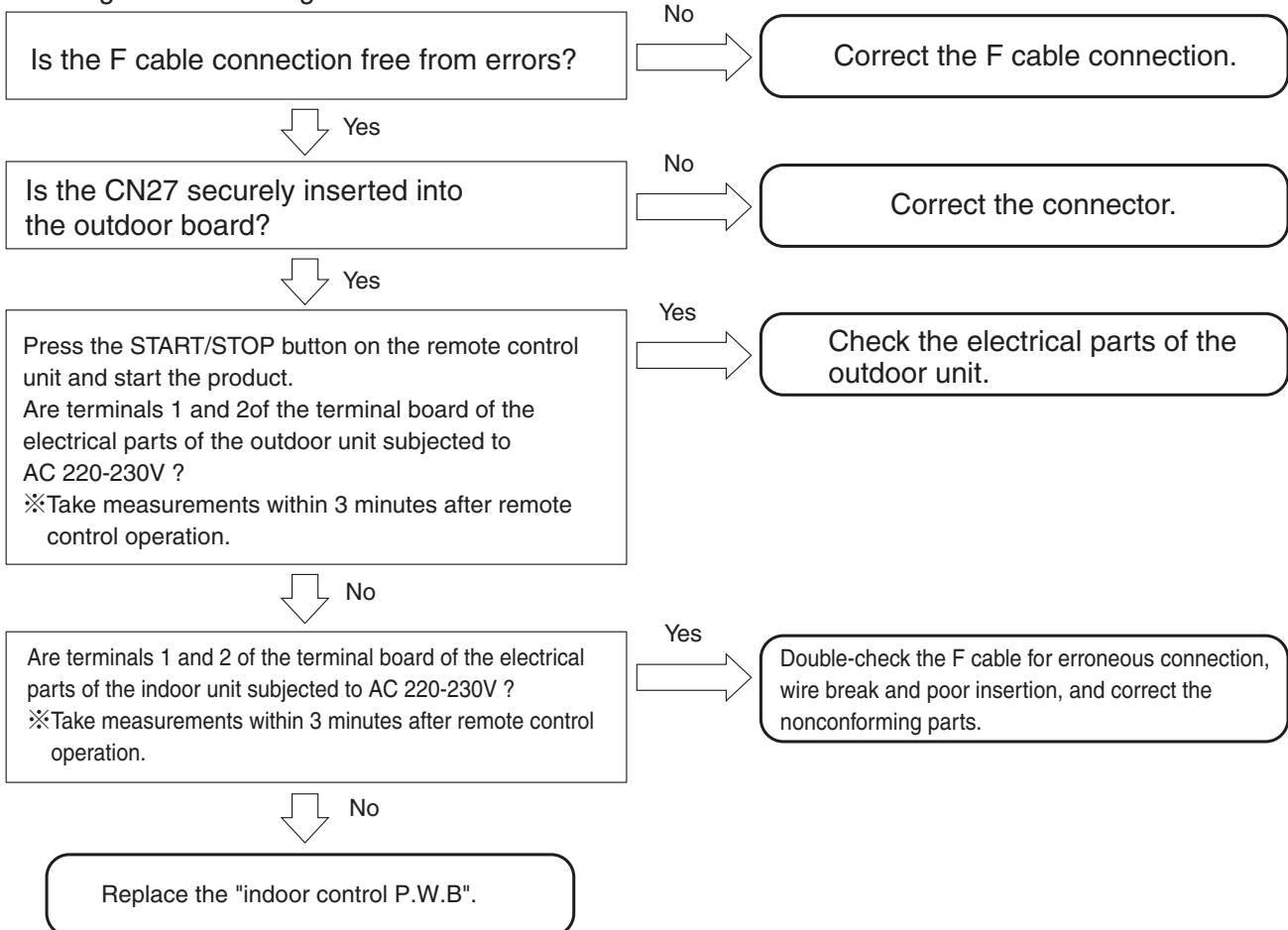
[Situation] The timer blinks 12 times and the product will not run.

- [Estimated failure locations]
- Erroneous connection in the indoor-outdoor connection line (F cable)
  - Forget to connect CN27 of outdoor P.W.B
  - Wire break or poor insertion of the indoor-outdoor connection line (F cable)
  - Electrical parts in the outdoor unit (communication circuit, power circuit error)
  - Communication error due to noise in other home electronics
  - ※This does not constitute a failure in the air-conditioner

[Cautions] • When lines 1 and 2 of F cable are erroneously connected (crossed), the product may not enter self-diagnosis display mode. If the self-diagnosis memory stores data about "timer lamp blinked 12 times", then, just in case, check if the F cable is not erroneously connected.

[Diagnosis flow]

Initiating troubleshooting



## 13. Timer lamp blinking: blinking 13 times

[Situation] The timer lamp blinks 13 times and the product will not run.

[Estimated failure location] • EEPROM, microcomputer

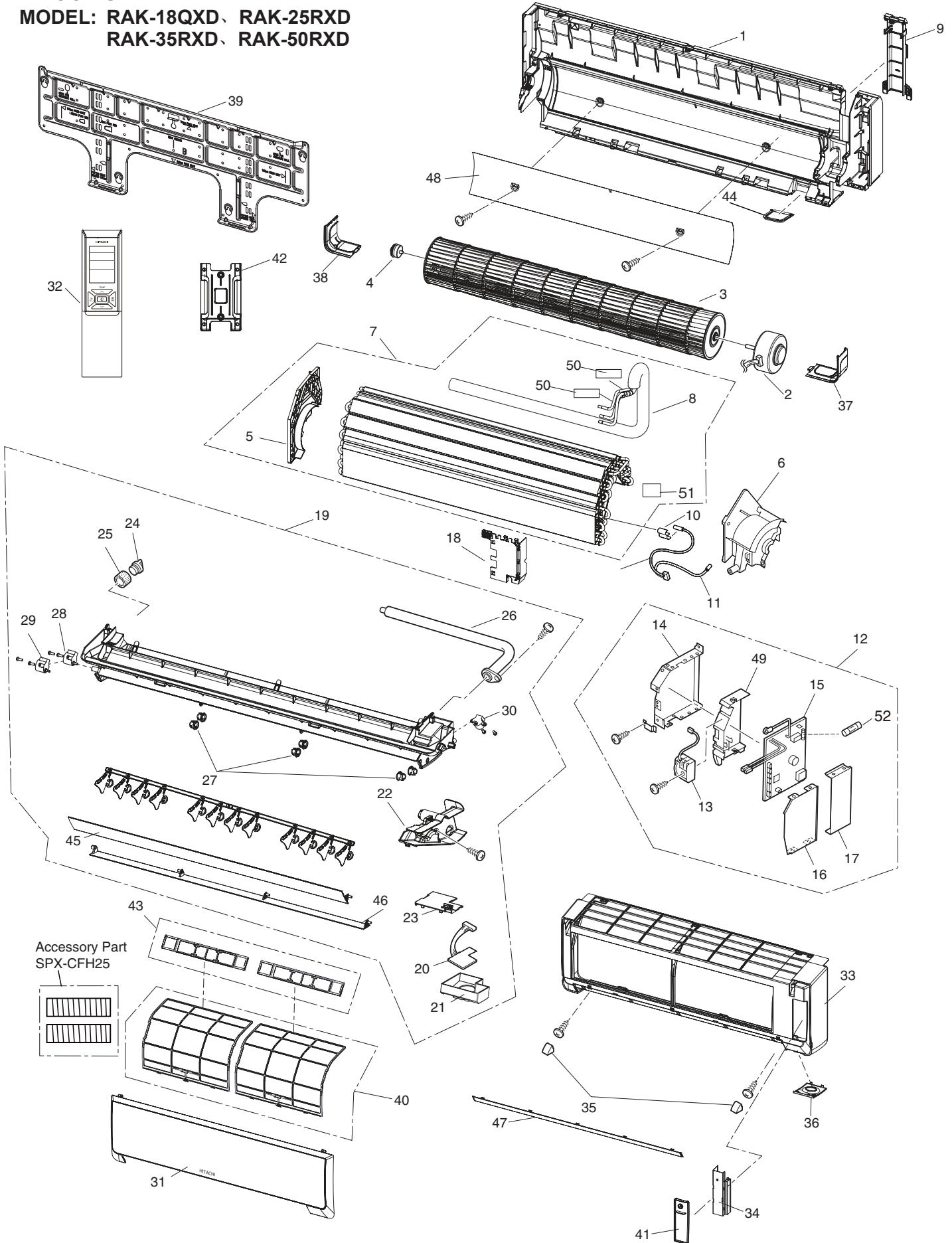
[Diagnosis flow]

Replace the "indoor control P.W.B".

# PARTS LIST AND DIAGRAM

## INDOOR UNIT

MODEL: RAK-18QXD、RAK-25RXD  
RAK-35RXD、RAK-50RXD



## INDOOR UNIT

NO	JCH-WH PARTS NO				Q' T Y/U NIT	PARTS NAME
	RAK-18QXD	RAK-25RXD	RAK-35RXD	RAK-50RXD		
1		HWRAK-35PPB	901		1	CABINET ASS'Y
2		HWRAS-K10HCG	903		1	FAN MOTOR
3		HWRAK-35PPB	902		1	TANGENTIAL AIR FLOW FAN
4		HWRAK-25RXD	A01		1	FAN SUPPORT ASS'Y
5		HWRAK-25RXD	A02		1	FAN COVER
6		HWRAK-35PPB	904		1	FAN MOTOR SUPPORT
7	HWRAK-25RXD	A03	HWRAK-50RXD	A01	1	EVAPORATOR ASS'Y
8	HWRAK-25RXD	A04	HWRAK-50RXD	A02	1	PIPING ASS'Y
9		HWRAK-35RPB	901		1	UPPER COVER
10		HWRAS-25YH4	A15		1	SPRING
11		HWRAS-E10H3	911		1	THERMISTOR ASS'Y
12	HWRAK-18QXD A01	HWRAK-25RXD A05	HWRAK-35RXD A01	HWRAK-50RXD A03	1	ELECTRIC ASSEMBLY
13		HWRAK-25PXB	919		1	TERMINAL BOARD (3P)
14		HWRAK-25PXB	902		1	COVER (ELECTRIC)
15	HWRAK-18QXD A02	HWRAK-25RXD A06	HWRAK-35RXD A02	HWRAK-50RXD A04	1	P.W.B.(MAIN)
16	HWRAK-18QXD	A03	HWRAK-25RXD	A07	1	ELEC-COVER-1
17		HWRAK-25PXB	905		1	ELEC-COVER-2
18		HWRAK-35RPB	905		1	PIPE COVER
19		HWRAK-25PXB	906		1	DRAIN PAN ASS'Y
20		HWRAK-25PXB	907		1	P.W.B.(INDICATION)
21		HWRAK-25RXD	A08		1	LED-COVER
22		HWRAK-35PPB	913		1	FC-GUIDE
23		HWRAK-25PXB	909		1	K-SUP
24		HWRAS-25YH4	A30		1	DRAIN CAP
25		HWRAS-25YH4	A31		1	FO-PIPE
26		HWRAK-18RPD	A10		1	DRAINAGE PIPE
27		HWRAS-25YH4	A28		6	DEFLECTOR SUPPORT
28		HWRAK-25PXB	910		1	STEPPING MOTOR
29		HWRAK-25PXB	911		1	STEPPING MOTOR
30		HWRAK-25PXB	912		1	STEPPING MOTOR (VERTICAL AIR DEFLECTOR)
31		HWRAK-25PXB	913		1	FRONT PANEL ASS'Y
32		HWRAK-35RPC	906		1	REMOTE CONTROL ASS'Y
33		HWRAK-25RXD	A09		1	FRONT COVER AS
34		HWRAK-18QXB	903		1	T-COVER ASS'Y
35		HWRAK-35PPB	920		2	CAP
36		HWRAK-25PXB	916		1	SE-COVER
37		HWRAK-25PXB	917		1	S-COVER-R
38		HWRAK-25PXB	918		1	S-COVER-L
39		HWRAK-25RXD	A10		1	MOUNTING PLATE
40		HWRAK-25PXB	920		2	AIR FILTER
41		HWRAK-25PXB	921		1	TER-COVER
42		HWRAK-18PPB	902		1	RE-HOLDER
43		HWRAK-35PPB	927		2	F-CASE
44		HWRAK-35PPB	929		1	T-PLATE
45		HWRAK-25PXB	922		1	HORIZONTAL AIR DEFLECTOR 1
46		HWRAK-25PXB	923		1	HORIZONTAL AIR DEFLECTOR 2
47		HWRAK-25PXB	924		1	K-PANEL
48		HWRAK-25PXB	925		1	CABI-PLATE
49		HWRAK-25PXB	926		1	SUPPORT (P.W.B.)
50		HWRAK-50RPB	903		2	BUTYL
51		HWRAK-50RPB	904		1	BUTYL
52		HWRAC-25WXD	A11		1	FUSE (3. 15A)



# HITACHI

---

RAK-18QXD  
RAK-25RXD  
RAK-35RXD  
RAK-50RXD

JCH-WH NO.0111E