

## SERVICE MANUAL TECHNICAL INFORMATION

FOR SERVICE PERSONNEL ONLY

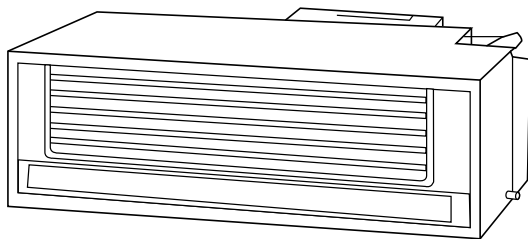

RAD-18QPB  
RAD-25QPB  
RAD-35QPB  
RAD-50QPB

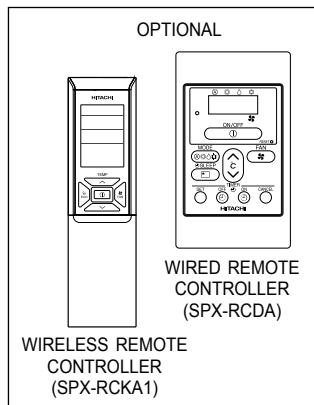

REFER TO THE FOUNDATION MANUAL

### CONTENTS

SPECIFICATIONS.....	5
HOW TO USE .....	7
CONSTRUCTION AND DIMENSIONAL DIAGRAM.....	52
MAIN PARTS COMPONENT .....	54
WIRING DIAGRAM .....	55
CIRCUIT DIAGRAM .....	57
BLOCK DIAGRAM .....	63
PRINTED WIRING BOARD LOCATION DIAGRAM .....	64
BASIC MODE .....	67
REFRIGERATING CYCLE DIAGRAM.....	81
DESCRIPTION OF MAIN CIRCUIT OPERATION.....	82
SERVICE CALL Q & A.....	90
TROUBLE SHOOTING .....	93
DISMANTLE AND RE-ASSEMBLE PROCEDURE.....	121
PARTS LIST AND DIAGRAM.....	123

### SPECIFICATIONS

TYPE		DC INVERTER (DUCT TYPE)						
		INDOOR UNIT						
MODEL		RAD-18QPB	RAD-25QPB	RAD-35QPB	RAD-50QPB			
POWER SOURCE		1 PHASE, 50/60Hz, 220-240V						
COOLING	TOTAL INPUT (W)	REFER TO THE OUTDOOR SPECIFICATION						
	TOTAL AMPERES (A)							
	CAPACITY					(kW)	(B.T.U./h)	
HEATING	TOTAL INPUT (W)							
	TOTAL AMPERES (A)							
	CAPACITY					(kW)	(B.T.U./h)	
DIMENSIONS (mm)	W					750		
	H					235		
	D	400						
NET WEIGHT (kg)		16						

SPECIFICATIONS AND PARTS ARE SUBJECT TO CHANGE FOR IMPROVEMENT

## ROOM AIR CONDITIONER

INDOOR UNIT + OUTDOOR UNIT



## WORKING STANDARDS FOR PREVENTING BREAKAGE OF SEMICONDUCTORS

### 1. Scope

The standards provide for items to be generally observed in carrying and handling semiconductors in relative manufacturers during maintenance and handling thereof. (They apply the same to handling of abnormal goods such as rejected goods being returned).

### 2. Object parts

- (1) Micro computer
- (2) Integrated circuits (I.C.)
- (3) Field-effective transistor (F.E.T.)
- (4) P.C. boards or the like to which the parts mentioned in (1) and (2) of this paragraph are equipped.

### 3. Items to be observed in handling

- (1) Use a conductive container for carrying and storing of parts. (Even rejected goods should be handled in the same way).

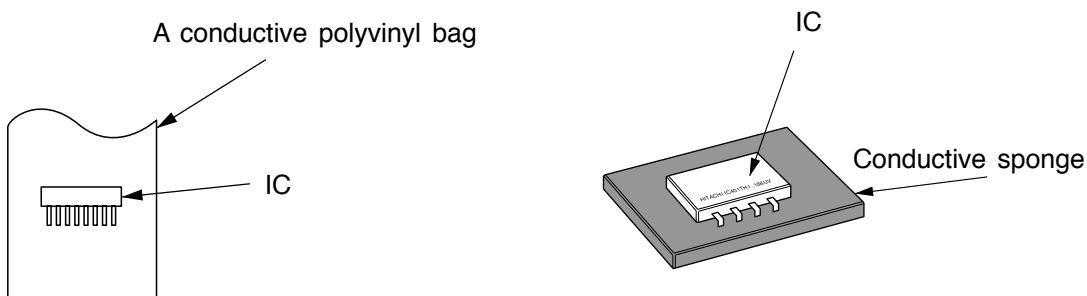

Fig. 1. Conductive container

- (2) When any part is handled uncovered (in counting, packing and the like), the handling person must always use himself as a body earth. (Make yourself a body earth by passing  $1M\Omega$  earth resistance through a ring or bracelet).
- (3) Be careful not to touch the parts with your clothing when you hold a part even if a body earth is being taken.
- (4) Be sure to place a part on a metal plate with grounding.
- (5) Be careful not to fail to turn off power when you repair the printed circuit board. At the same time, try to repair the printed circuit board on a grounded metal plate.

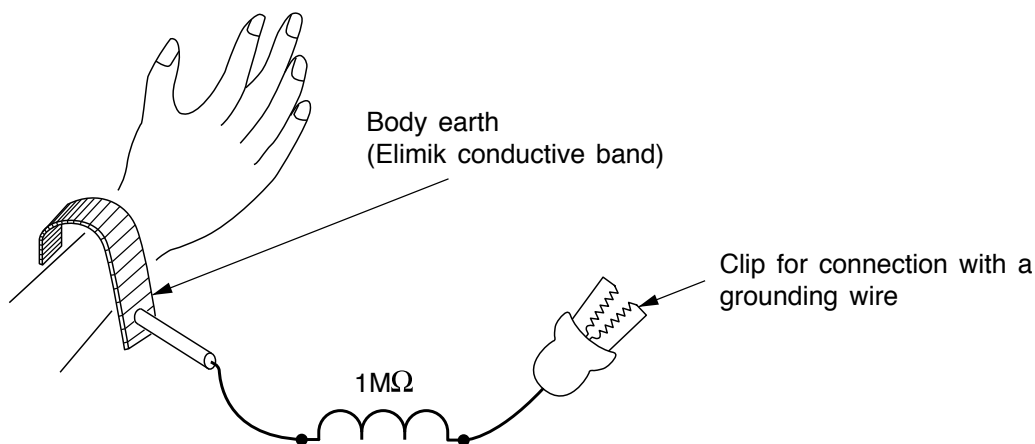

Fig. 2. Body Earth

(6) Use a three wire type soldering iron including a grounding wire.

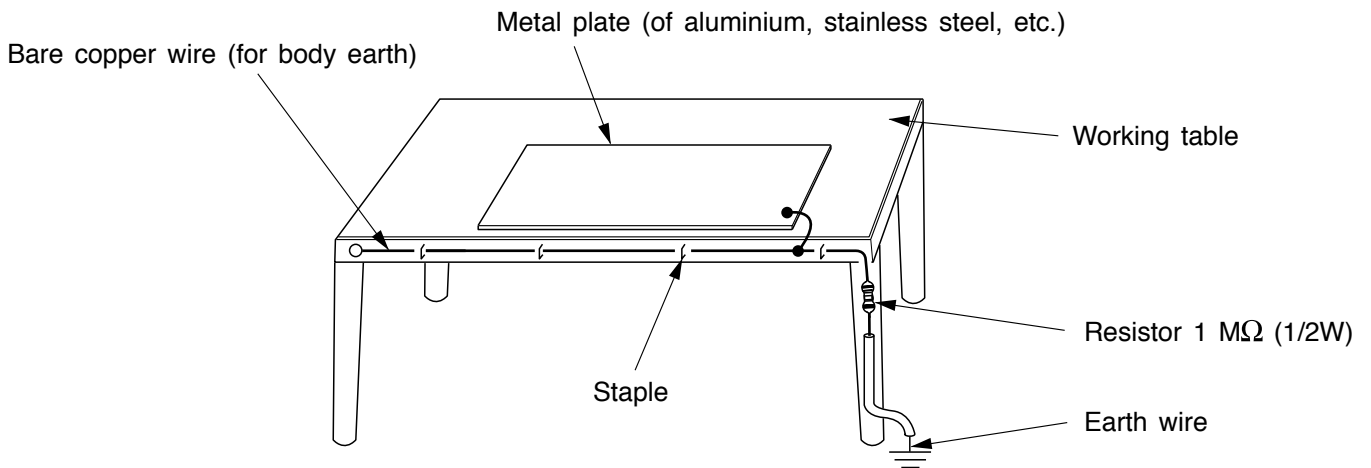

Fig. 3. Grounding of the working table

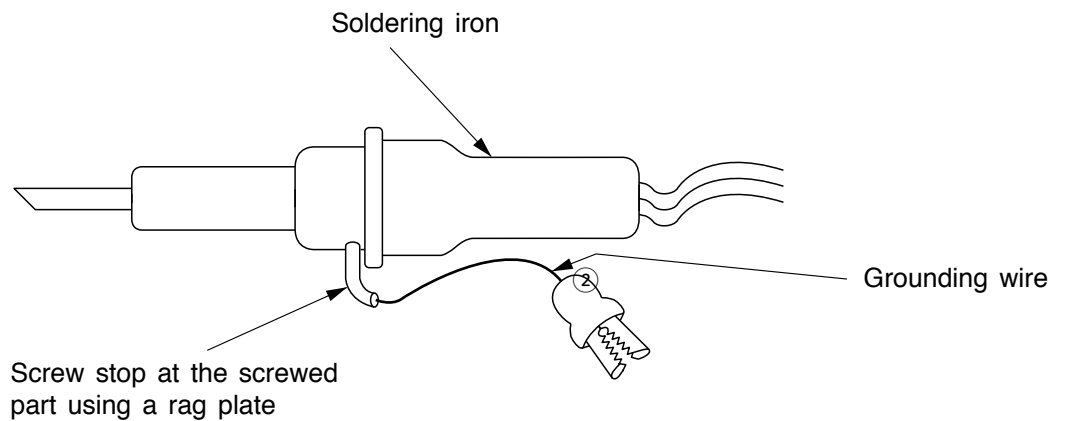

Fig. 4. Grounding a solder iron

Use a high insulation mode (100V, 10MΩ or higher) when ordinary iron is to be used.

(7) In checking circuits for maintenance, inspection or some others, be careful not to have the test probes of the measuring instrument short circuit a load circuit or the like.

 **CAUTION**

1. In quiet or stop operation, slight flowing noise of refrigerant in the refrigerating cycle is heard occasionally, but this noise is not abnormal for the operation.
2. When it thunders nearby, it is recommend to stop the operation and to disconnect the power cord plug from the power outlet for safety.
3. In the event of power failure, the air conditioner will restart automatically in the previously selected mode once the power is restored. In the event of power failure during TIMER operation, the air conditioner will not start automatically. Re-press ON/OFF button after 3 minutes from when the unit off or power recovery.
4. If the room air conditioner is stopped by adjusting thermostat, or miss operation, and re-start in a moment, there is occasion that the cooling and heating operation does not start for 3 minutes, it is not abnormal and this is the result of the operation of IC delay circuit. This IC delay circuit ensures that there is no danger of blowing fuse or damaging parts even if operation is restarted accidentally.
5. This room air conditioner should not be used at the cooling operation when the outside temperature is below  $-10^{\circ}\text{C}$  ( $14^{\circ}\text{F}$ ).
6. This room air conditioner (the reverse cycle) should not be used when the outside temperature is below  $-15^{\circ}\text{C}$  ( $5^{\circ}\text{F}$ ).  
If the reverse cycle is used under this condition, the outside heat exchanger is frosted and efficiency falls.
7. When the outside heat exchanger is frosted, the frost is melted by operating the hot gas system, it is not trouble that at this time fan stops and the vapour may rise from the outside heat exchanger.

## SPECIFICATIONS

MODEL	RAD-18QPB RAD-25QPB RAD-35QPB RAD-50QPB
FAN MOTOR	30W
FAN MOTOR CAPACITOR	NO
FAN MOTOR PROTECTOR	NO
COMPRESSOR	–
COMPRESSOR MOTOR CAPACITOR	NO
OVERLOAD PROTECTOR	NO
OVERHEAT PROTECTOR	NO
FUSE (for MICROPROCESSOR)	3.15A
POWER RELAY	NO
POWER SWITCH	NO
TEMPORARY SWITCH	YES
SERVICE SWITCH	NO
TRANSFORMER	NO
VARISTOR	450NR
NOISE SUPPRESSOR	NO
THERMOSTAT	YES(IC)
REMOTE CONTROL SWITCH (LIQUID CRYSTAL)	YES

## [Indoor unit installation]

### ⚠ CAUTION

Always install the indoor unit at level. If the indoor unit is inclined, water may leak.

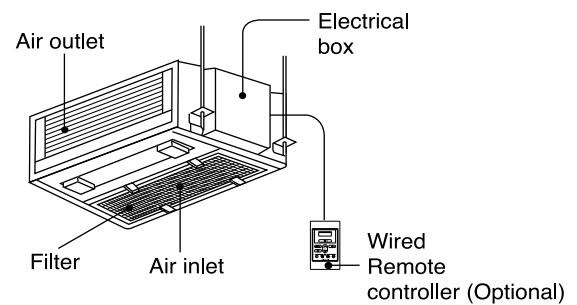
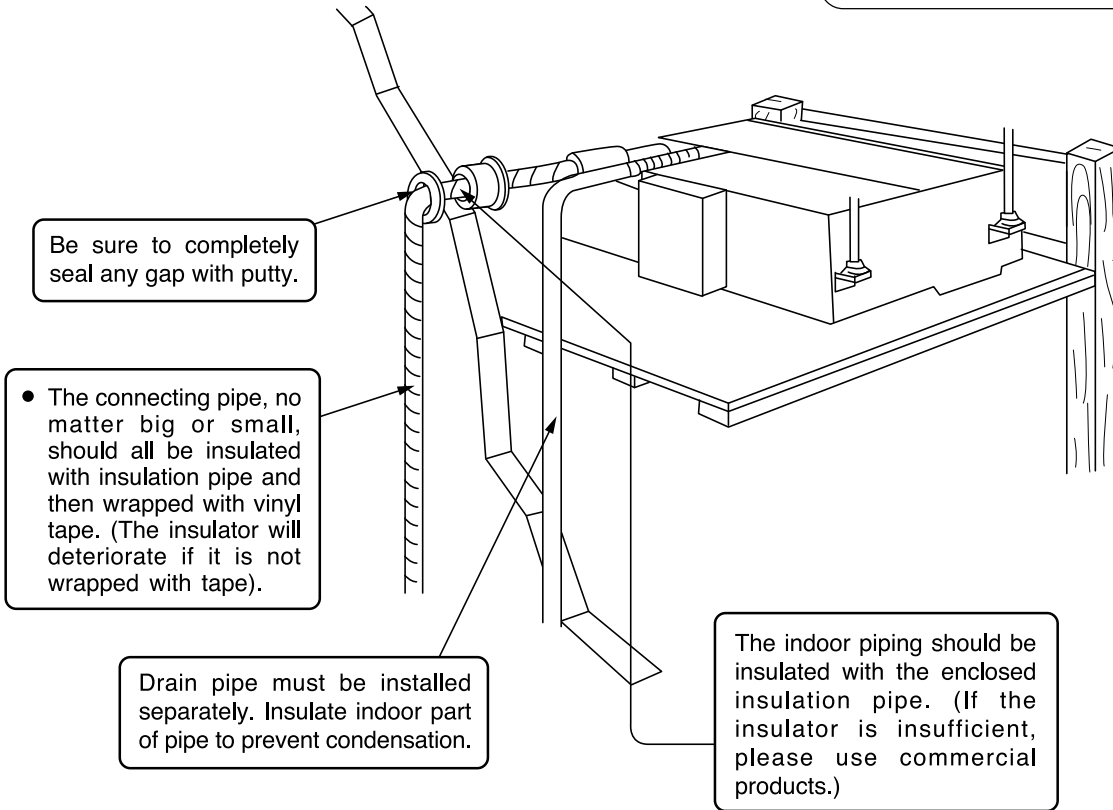

- “Height difference” and “Piping length” of Indoor and Outdoor unit are different by Outdoor unit. Please refer to the installation manual in Outdoor unit.



# SAFETY PRECAUTION

- Please read the “Safety Precaution” carefully before operating the unit to ensure correct usage of the unit.
- Pay special attention to signs of “▲ Warning” and “▲ Caution”. The “Warning” section contains matters which, if not observed strictly, may cause death or serious injury. The “Caution” section contains matters which may result in serious consequences if not observed properly. Please observe all instructions strictly to ensure safety.
- The sign indicate the following meanings.

Make sure to connect earth line.	The sign in the figure indicates prohibition.
Indicates the instructions that must be followed.	

- Please keep this manual after reading.

## PRECAUTIONS DURING INSTALLATION

<b>▲ WARNING</b>	<ul style="list-style-type: none"> <li>● Do not reconstruct the unit. Water leakage, fault, short circuit or fire may occur if you reconstruct the unit by yourself.</li> </ul>	
	<ul style="list-style-type: none"> <li>● Please ask your sales agent or qualified technician for the installation of your unit. Water leakage, short circuit or fire may occur if you install the unit by yourself.</li> </ul>	
	<ul style="list-style-type: none"> <li>● Please use earth line. Do not place the earth line near water or gas pipes, lightning-conductor, or the earth line of telephone. Improper installation of earth line may cause electric shock.</li> </ul>	
<b>▲ CAUTION</b>	<ul style="list-style-type: none"> <li>● A circuit breaker should be installed depending on the mounting site of the unit. Without a circuit breaker, the danger of electric shock exists.</li> </ul>	
	<ul style="list-style-type: none"> <li>● Do not install near location where there is flammable gas. The outdoor unit may catch fire if flammable gas leaks around it.</li> </ul>	
	<ul style="list-style-type: none"> <li>● Please ensure smooth flow of water when installing the drain hose.</li> </ul>	

## PRECAUTIONS DURING SHIFTING OR MAINTENANCE

<b>▲ WARNING</b>	<ul style="list-style-type: none"> <li>● Should abnormal situation arises (like burning smell), please stop operating the unit and turn off the circuit breaker. Contact your agent. Fault, short circuit or fire may occur if you continue to operate the unit under abnormal situation.</li> </ul>	
	<ul style="list-style-type: none"> <li>● Please contact your agent for maintenance. Improper self maintenance may cause electric shock and fire.</li> </ul>	
	<ul style="list-style-type: none"> <li>● Please contact your agent if you need to remove and reinstall the unit. Electric shock or fire may occur if you remove and reinstall the unit yourself improperly.</li> </ul>	
	<ul style="list-style-type: none"> <li>● If the supply cord is damaged, it must be replaced by the special cord obtainable at authorized service/parts centers.</li> </ul>	

## PRECAUTIONS DURING OPERATION

<b>▲ WARNING</b>	<ul style="list-style-type: none"> <li>● Avoid an extended period of direct air flow for your health.</li> </ul>	
	<ul style="list-style-type: none"> <li>● Do not insert a finger, a rod or other objects into the air outlet or inlet. As the fan is rotating at a high speed, it will cause injury. Before cleaning, be sure to stop the operation and turn the breaker OFF.</li> </ul>	
	<ul style="list-style-type: none"> <li>● Do not use any conductor as fuse wire, this could cause fatal accident.</li> </ul>	
	<ul style="list-style-type: none"> <li>● During thunder storm, disconnect and turn off the circuit breaker.</li> </ul>	



## PRECAUTIONS DURING OPERATION

- The product shall be operated under the manufacturer specification and not for any other intended use.

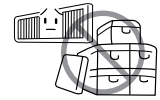

- Do not attempt to operate the unit with wet hands, this could cause fatal accident.

- When operating the unit with burning equipments, regularly ventilate the room to avoid oxygen insufficiency.

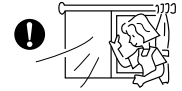

- Do not direct the cool air coming out from the air-conditioner panel to face household heating apparatus as this may affect the working of apparatus such as the electric kettle, oven etc.

- Please ensure that outdoor mounting frame is always stable, firm and without defect. If not, the outdoor unit may collapse and cause danger.



- Do not splash or direct water to the body of the unit when cleaning it as this may cause short circuit.

- Do not use any aerosol or hair sprays near the indoor unit. This chemical can adhere on heat exchanger fin and blocked the evaporation water flow to drain pan. The water will drop on tangential fan and cause water splashing out from indoor unit.



- Please switch off the unit and turn off the circuit breaker during cleaning, the high-speed fan inside the unit may cause danger.

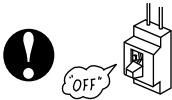

- Turn off the circuit breaker if the unit is not to be operated for a long period.



- Do not climb on the outdoor unit or put objects on it.

- Do not put water container (like vase) on the indoor unit to avoid water dripping into the unit. Dripping water will damage the insulator inside the unit and causes short-circuit.

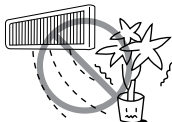

- Do not place plants directly under the air flow as it is bad for the plants.

- When operating the unit with the door and windows opened, (the room humidity is always above 80%) and with the air deflector facing down or moving automatically for a long period of time, water will condense on the air deflector and drips down occasionally. This will wet your furniture. Therefore, do not operate under such condition for a long time.

- If the amount of heat in the room is above the cooling or heating capability of the unit (for example: more people entering the room, using heating equipments and etc.), the preset room temperature cannot be achieved.

- This appliance can be used by children aged from 8 years and above and persons with reduced physical, sensory or mental capabilities or lack of experience and knowledge if they have been given supervision or instruction concerning use of the appliance in a safe way and understand the hazards involved. Children shall not play with the appliance. Cleaning and user maintenance shall not be made by children without supervision.



C  
A  
U  
T  
I  
O  
N

# MULTI-AIR CONDITIONER

Several indoor units can be connected to one outdoor unit. You can operate only one unit or several units according to your needs.

## Combination of Operations:

When operation mode is selected:

- You cannot operate the indoor units in the following combinations.

One unit	Other unit
Heating	Cooling
	Dehumidifying
	Fan

- The indoor unit which is turned on first continues to operate. Other indoor units which are turned on later go into standby mode and the operation lamp lights.
- To operate the indoor units turned on later, set the operation mode as same as the indoor unit turned on first.

During automatic operation:

- When heating operation is automatically selected for the first indoor unit, the next indoor unit will then start to heat. Also, if cooling or dehumidifying is automatically selected for the first indoor unit, the next indoor unit will also start to cool or dehumidify.

## Adjusting the Number of Indoor Units:

Decrease the number of indoor units to be operated especially when it is very hot or cold or when you want to reach the present temperature quickly.

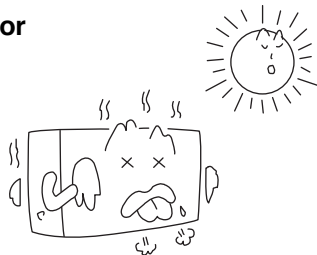

## Stopped Indoor Units:

When an indoor unit is operated in the cooling, heating or dehumidifying mode in the room, the sound of refrigerant flow may be heard from a stopped indoor unit or a stopped indoor unit may become warm. This is because the indoor unit returns refrigerant to the outdoor unit to be ready for operation.

## OPERATING RANGE

Operation mode	Cooling / Dehumidifying	Heating
Outdoor temperature	-10 to 43°C	-15 to 21°C

# NAMES AND FUNCTIONS OF EACH PART

---

## INDOOR UNIT

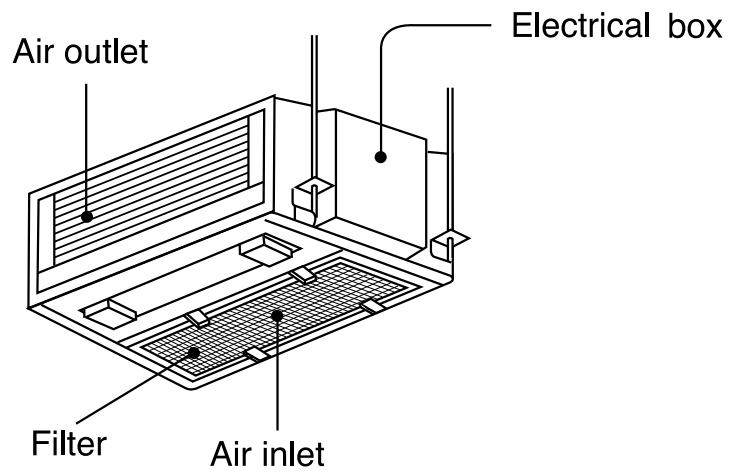

## MODEL NAME AND DIMENSIONS

MODEL	WIDTH (mm)	HEIGHT (mm)	DEPTH (mm)
RAD-18QPB/RAD-25QPB/RAD-35QPB/RAD-50QPB	750	235	400

## Note

- The recommended temperature range for safety testing should be as below:

		Cooling		Heating	
		Minimum	Maximum	Minimum	Maximum
Indoor	Dry bulb °C	21	32	20	27
	Wet bulb °C	15	23	12	19
Outdoor	Dry bulb °C	21	43	2	21
	Wet bulb °C	15	26	1	15

## CIRCUIT BREAKER

When you do not use the room air conditioner, set the circuit breaker to “OFF”.

## HOW TO USE THE AIR CONDITIONER EFFECTIVELY

### 1. An average room temperature setting is probably the best for you as well as being economical.

- Excessive cooling or heating is not recommended for health reasons. High electricity bills may also result.
- Close the curtains or blinds to prevent heat from flowing into or escaping the room as well as to make more effective use of electricity.



### 2. At intervals, the doors and windows should be opened to let fresh air in.



Make sure the room is ventilated when operating the air conditioner at the same time as other heating appliances.



### 3. Using the timer is recommended before going to sleep or going out.



### 4. The following must never be used for cleaning the indoor and outdoor units.

- Benzene, thinner and scrub can damage plastic surfaces or coating.
- Hot water above 40°C can shrink the filter and deform plastic parts.



### 5. Do not block the air intake and air outlet.

- Do not block the air outlets and intakes of the indoor and outdoor units with curtains or other obstacles which could degrade air conditioner performance and cause unit failure.

# THE IDEAL WAYS OF OPERATION

## Suitable Room Temperature

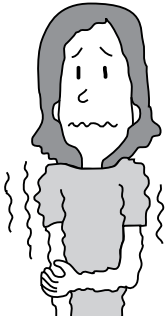

### ⚠ Warning

Freezing temperature is bad for health and a waste of electric power.

## Install curtain or blinds

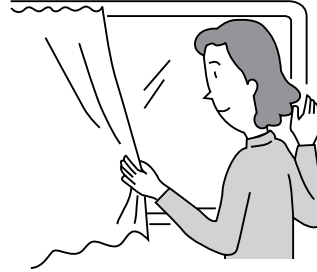

It is possible to reduce heat entering the room through windows.

## Ventilation

### ⚠ Caution

Do not close the room for a long period of time. Occasionally open the door and windows to allow the entrance of fresh air.



## Effective Usage Of Timer

At night, please use the “OFF or ON timer operation mode”, together with your wake up time in the morning. This will enable you to enjoy a comfortable room temperature. Please use the timer effectively.

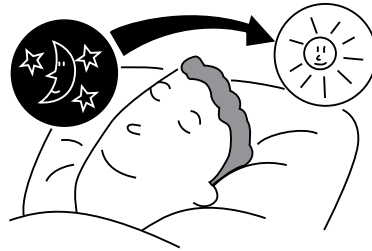

## Do Not Forget To Clean The Pre-Filter

Dusty air filter will reduce the air volume and the cooling efficiency. To prevent from wasting electric energy, please clean the filter every 2 weeks.

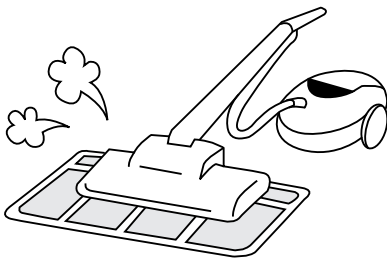

## Please Adjust Suitable Temperature For Baby And Children

Please pay attention to the room temperature and air flow direction when operating the unit for baby, children and old folks who have difficulty in movement.

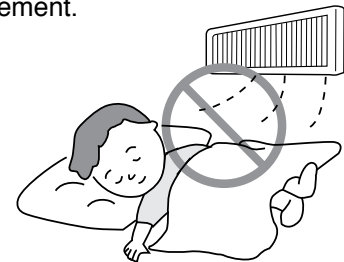

# FOR USER'S INFORMATION

## The Air Conditioner And The Heat Source In The Room

### ⚠ Caution

If the amount of heat in the room is above the cooling capability of the air conditioner (for example: more people entering the room, using heating equipments and etc.), the preset room temperature cannot be achieved.

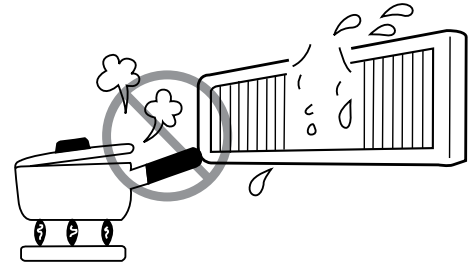

## Not Operating For A Long Time

When the indoor unit is not to be used for a long period of time, please switch off the power from the mains. If the power from mains remains "ON", the indoor unit still consumes about 10W (depends on outdoor unit connected) in the operation control circuit even if it is in "OFF" mode.

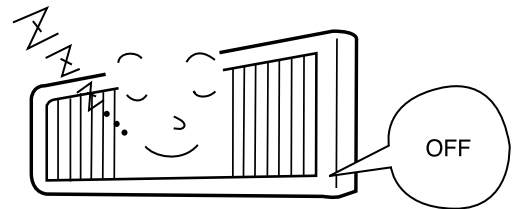

## When Lightning Occurs

### ⚠ Warning

To protect the whole unit during lightning, please stop operating the unit and remove the plug from the socket.

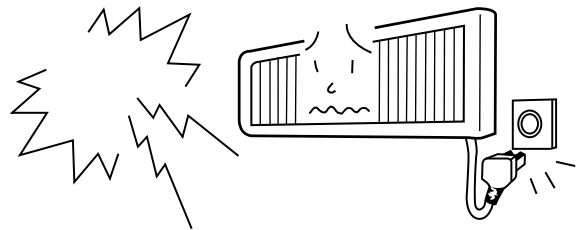

## Interference From Electrical Products

### ⚠ Caution

To avoid noise interference, please place the indoor unit and its remote controller at least 1m away from electrical products.

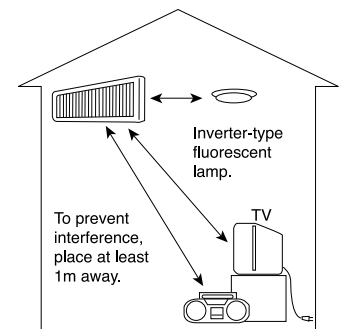

# MAINTENANCE

## ⚠ WARNING

- Before cleaning, stop unit operation with the remote controller and turn off the circuit breaker.

## ⚠ CAUTION

- Do not expose the unit to water as it may cause an electric shock.
- For cleaning inside the air conditioner, consult your sales agent.
- Avoid using detergent when cleaning the heat exchanger of the indoor unit. Unit failure may result.
- When cleaning the heat exchanger with a vacuum cleaner, make sure to wear gloves so as not to injure your hands on the heat exchanger fins.

## 1. PRE-FILTER

Clean the pre-filter, as it removes dust inside the room. Be sure to clean the filter once every two weeks so as not to consume electricity unnecessarily.

### PROCEDURE

- 1** Pull the filter toward the center until it detached from the holders. Then take it out from holders (refer to diagram).
- 2** Remove dust from the filter using a vacuum cleaner. If there is too much dust, use neutral detergent. After using neutral detergent, wash with clean water and dry in the shade.
- 3** Install the filters.  
Gently insert back the filter into the holders.

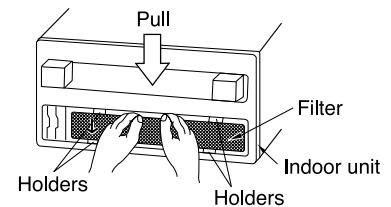
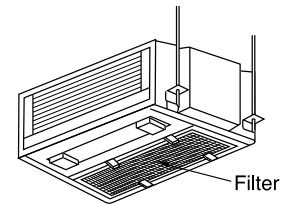

## ⚠ CAUTION

- Do not wash with hot water at more than 40°C. The filter may shrink.
- When washing it, shake off moisture completely and dry it in the shade; do not expose it directly to the sun. The filter may shrink.
- Do not operate the air conditioner with the filter removed. Dust may enter the air conditioner and cause trouble.

# REGULAR INSPECTION

PLEASE CHECK THE FOLLOWING POINTS BY QUALIFIED SERVICE PERSONNEL EITHER EVERY HALF YEARLY OR YEARLY. CONTACT YOUR SALES AGENT OR SERVICE SHOP.

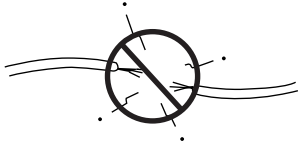
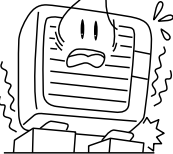
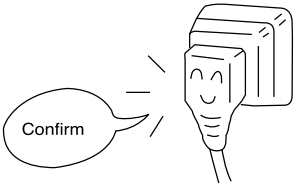
1		Is the earth line disconnected or broken?
2		Is the mounting frame seriously affected by rust and is the outdoor unit tilted or unstable?
3		Is the plug of power line firmly plugged into the socket? (Please ensure no loose contact between them).

## AFTER SALE SERVICE AND WARRANTY

### WHEN ASKING FOR SERVICE, CHECK THE FOLLOWING POINTS.

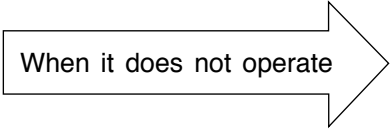
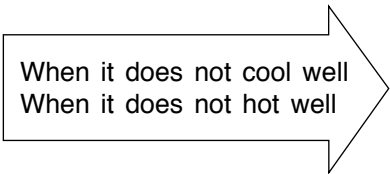
CONDITION	CHECK THE FOLLOWING POINTS
	<ul style="list-style-type: none"> <li>● Is the fuse all right?</li> <li>● Is the voltage extremely high or low?</li> <li>● Is the circuit breaker "ON"?</li> </ul>
	<ul style="list-style-type: none"> <li>● Was the air filter cleaned?</li> <li>● Does sunlight fall directly on the outdoor unit?</li> <li>● Is the air flow of the outdoor unit obstructed?</li> <li>● Are the doors or windows opened, or is there any source of heat in the room?</li> <li>● Is the set temperature suitable?</li> </ul>



**Notes**

- In quiet or stop operation, the following phenomena may occasionally occur, but they are not abnormal for the operation.
  - (1) Slight flowing noise of refrigerant in the refrigerating cycle.
  - (2) Slight rubbing noise from the fan casing which is cooled and then gradually warmed as operation stops.
- The odor will possibly be emitted from the room air conditioner because the various odor, emitted by smoke, foodstuffs, cosmetics and so on, sticks to it. So the air filter and the evaporator regularly must be cleaned to reduce the odor.







- Please contact your sales agent immediately if the air conditioner still fails to operate normally after the above inspections. Inform your agent of the model of your unit, production number, date of installation. Please also inform him regarding the fault.
- Power supply shall be connected at the rated voltage, otherwise the unit will be broken or could not reach the specified capacity.



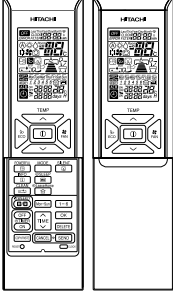

**PRECAUTIONS FOR USE**

- In case of power failure happen, Wired Remote Controller may not show current operating mode when power comes back. However unit will continue to operate at previous setting mode.
- Some features of Wireless Remote Controller are not available when use Wired Remote Controller as mentioned below:

Standard Wireless Remote Controller	Features not available on Wired Remote Controller
<p>RAR-6N5</p> 	<ul style="list-style-type: none"> <li>● Powerful </li> <li>● Information </li> <li>● One touch clean </li> <li>● Leave home </li> <li>● Silent </li> <li>● Weekly timer </li> </ul>

# NAMES AND FUNCTIONS OF REMOTE CONTROLLER

■ This controls the operation function and timer setting of the room air conditioner.

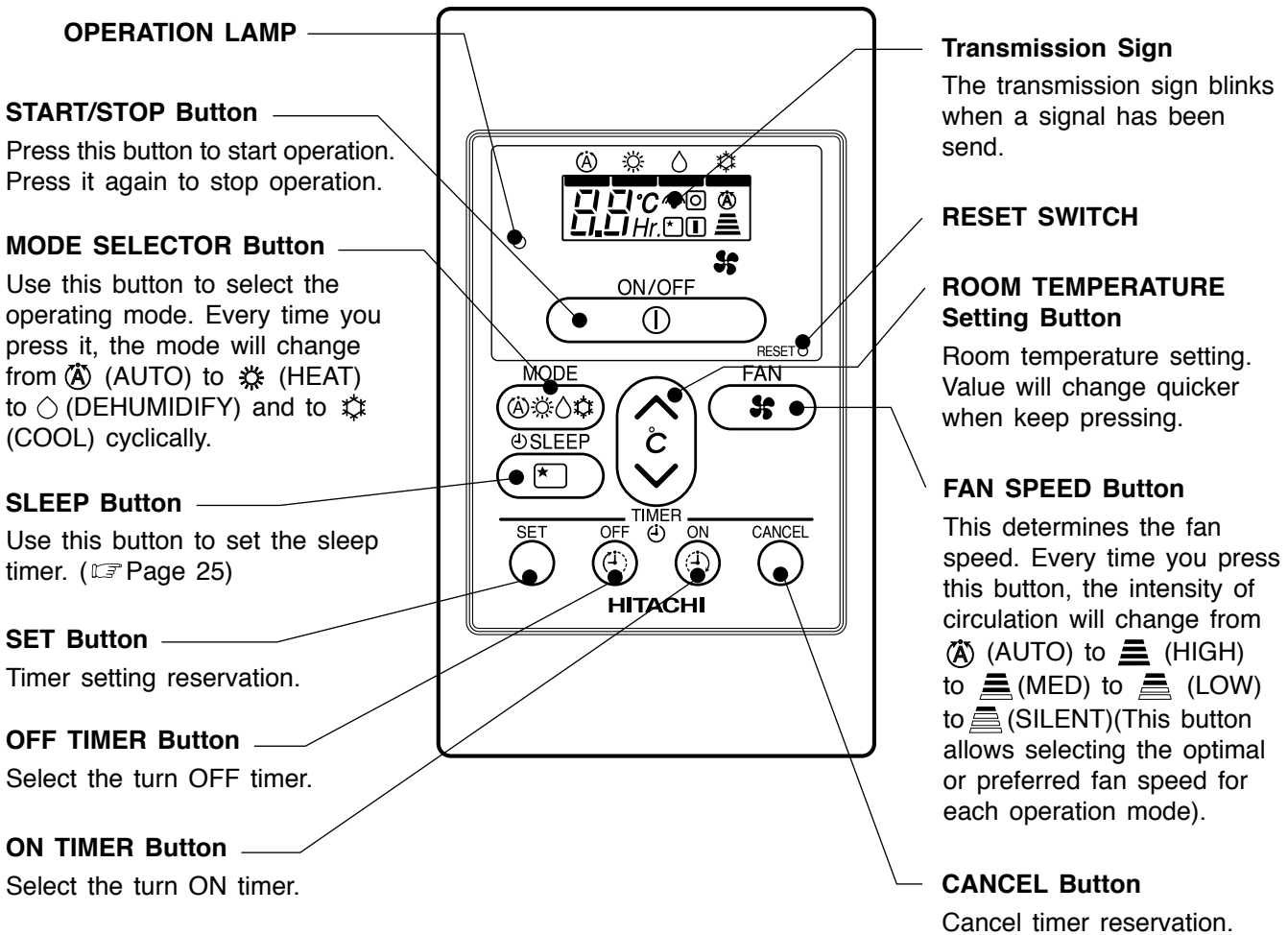

## Precautions for Use

- Do not put the remote controller in the following places.
  - Under direct sunlight.
  - In the vicinity of a heater.
- Handle the remote controller carefully. Do not drop it on the floor, and protect it from water.
- Once the outdoor unit stops, it will not restart for about 3 minutes (unless you turn the power switch off and on or unplug the power cord and plug it in again).  
This is to protect the device and does not indicate a failure.
- If you press the MODE SELECTOR button during operation, the device may stop for about 3 minutes for protection.

# VARIOUS FUNCTIONS

## Auto Restart Control

- If there is a power failure, operation will be automatically restarted when the power is resumed with previous operation mode.  
(As the operation is not stopped by remote controller.)
- If you intend not to continue the operation when the power is resumed, switch off the power supply. When you switch on the circuit breaker, the operation will be automatically restarted with previous operation mode.

Note: 1. If you do not require Auto Restart Control, please consult your sales agent.  
2. Auto Restart Control is not available when Timer or Sleep Timer mode is set.

## AUTOMATIC OPERATION

The device will automatically determine the mode of operation, HEAT or COOL depending on the current room temperature. The selected mode of operation will change when the room temperature varies.

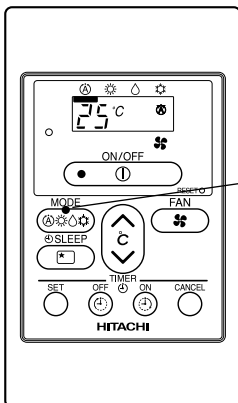

1

Press the MODE selector button so that the display indicates the (AUTO) mode of operation.

- When AUTO has been selected, the device will automatically determine the mode of operation, HEAT or COOL depending on the current room temperature. However the mode of operation will not change when indoor unit is connected to multi type outdoor unit.
- If the mode automatically selected by the unit is not satisfactory, manually change the mode setting (HEAT, DEHUMIDIFY or COOL).

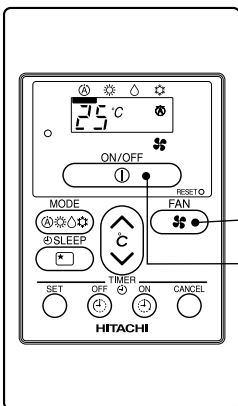

2

Press the (FAN SPEED) button to select AUTO, HIGH, MED, LOW or SILENT.

Set the desired FAN SPEED with the (FAN SPEED) button (the display indicates the setting).



**START  
STOP**

Press the (START/STOP) button.  
Operation starts.  
Press the button again to stop operation.

- As the settings are stored in the memory in the remote controller, you only have to press the (START/STOP) button next time.

# HEATING OPERATION

- Use the device for heating when the outdoor temperature is under 21°C.  
When it is too warm (over 21°C), the heating function may not work in order to protect the device.
- In order to maintain reliability of the device, please use this device when outdoor temperature is above -15°C

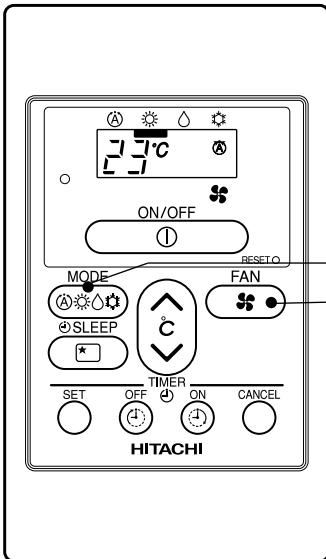

**1**

Press the MODE SELECTOR button so that the display indicates (HEAT).

Set the desired FAN SPEED with the (FAN SPEED) button (the display indicates the setting).

**2**



Set the desired room temperature with the ROOM TEMPERATURE setting button (the display indicates the setting).

**3**

The temperature setting and the actual room temperature may vary depending on conditions.

**START  
STOP**

Press the (START/STOP) button. Heating operation starts. Press the button again to stop operation.

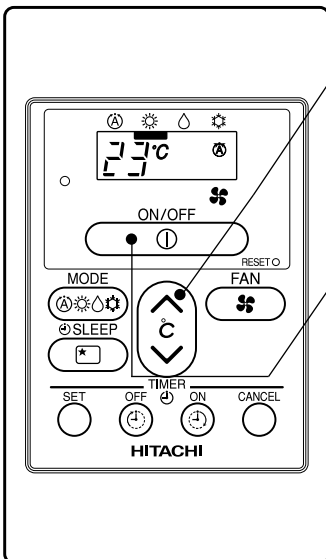

- As the settings are stored in the memory of the remote controller, you only have to press the (START/STOP) button next time.
- During AUTO fan, the fan speed automatically changes as below:
  - When the difference between room temperature and setting temperature is large, fan starts to run at HI speed.
  - After room temperature reaches the preset temperature, fan speed will be changed to lower speed to obtain optimum room temperature condition for natural healthy heating.

## Defrosting

Defrosting will be performed about once an hour when frost forms on the heat exchange of the outdoor unit, for 5~10 minutes each time.

During defrosting operation, the operation lamp blinks in a cycle of 3 seconds on and 0.5 second off.

The maximum time for defrosting is 20 minutes.

However, if the indoor unit is connected to multi type outdoor unit, the maximum time for defrosting is 15 minutes.

(If the piping length used is longer than usual, frost is likely to form.)

# DEHUMIDIFYING OPERATION

Use the device for dehumidifying when the room temperature is over 16°C.  
When it is under 15°C, the dehumidifying function will not work.

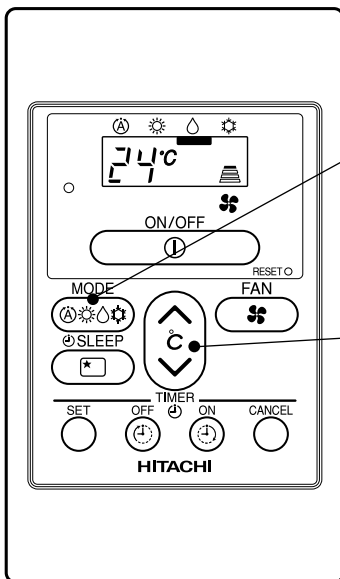

**1**

Press the MODE SELECTOR button so that the display indicates (DEHUMIDIFY).  
Press (FAN SPEED) button to select SILENT or LOW fan speed.

**2**

Set the desired room temperature with the ROOM TEMPERATURE setting button (the display indicates the setting).

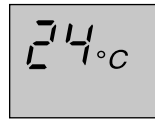

The range of 20-26°C is recommended as the room temperature for dehumidifying.

**START  
STOP**

Press the (START/STOP) button. Dehumidifying operation starts. Press the button again to stop operation.

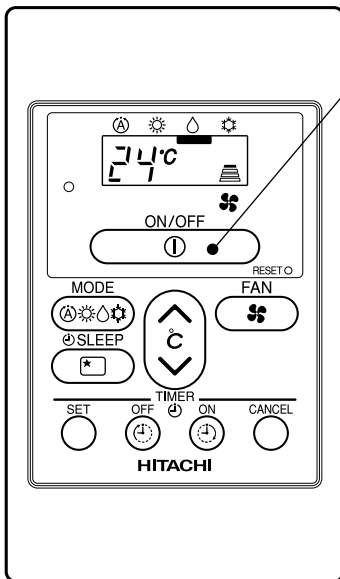

- As the settings are stored in the memory in the remote controller, you only have to press the (START/STOP) button next time.

## ■ Dehumidifying Function

- When the room temperature is higher than the temperature setting: The device will dehumidify the room, reducing the room temperature to the preset level.  
When the room temperature is lower than the temperature setting: Dehumidifying will be performed at the temperature setting slightly lower than the current room temperature, regardless of the temperature setting.
- The preset room temperature may not be reached depending on the number of people present in the room or other room conditions.

# COOLING OPERATION

Use the device for cooling when the outdoor temperature is  $-10\sim 43^{\circ}\text{C}$ .  
 If indoor humidity is very high (80%), some dew may form on the air outlet grille of the indoor unit.

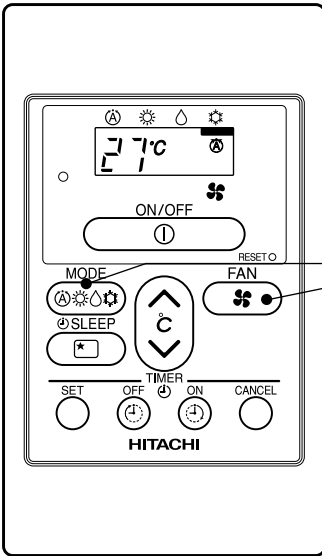

**1** Press the MODE SELECTOR button so that the display indicates  (COOL).

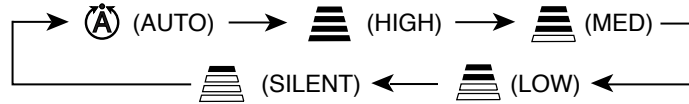

**2** Set the desired FAN SPEED with the  (FAN SPEED) button (the display indicates the setting).

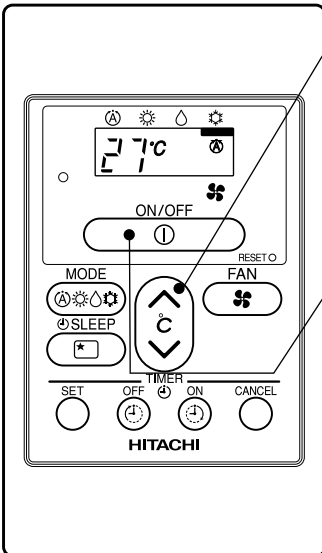

**3** Set the desired room temperature with the ROOM TEMPERATURE setting button (the display indicates the setting).

The temperature setting and the actual room temperature may vary depending on conditions.



**START STOP** Press the  (START/STOP) button. Cooling operation starts. Press the button again to stop operation. The cooling function does not start if the temperature setting is higher than the current room temperature (even though the  (OPERATION) lamp lights). The cooling function will start as soon as you set the temperature below the current room temperature.



- As the settings are stored in the memory of the remote controller, you only have to press the  (START/STOP) button next time.
- During AUTO fan, the fan speed automatically changes as below:
  - When the difference between room temperature and setting temperature is large, fan starts to run at HI speed.
  - After room temperature reaches the preset temperature, fan speed will be changed to lower speed to obtain optimum room temperature condition for natural healthy cooling.



## LEAVE HOME(LH) AND CLEAN (ONE TOUCH CLEAN) OPERATIONS

- Leave Home (LH) and CLEAN(One Touch Clean) operations activation buttons are not available on this device. The operations shall be activated by wireless remote controller.
- Please refer to wireless 'Remote Controller Manual' to activate the operations.

### NOTE

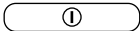
- If  or  is displayed on the wired remote controller display, the unit will operate Leave Home (LH) operation mode or CLEAN (One Touch Clean) which shall be activated by wireless remote controller.
- Push start/stop  button to stop Leave Home (LH) or CLEAN (One Touch Clean) operation.



# TIMER RESERVATION

■ ON Timer and OFF Timer are available.

## OFF Timer Reservation

### 1 ⌚ OFF TIMER setting

- Select the OFF TIMER by pressing the ⌚ (OFF) Button.
- Setting timer will change according to the below sequence when you press the button.

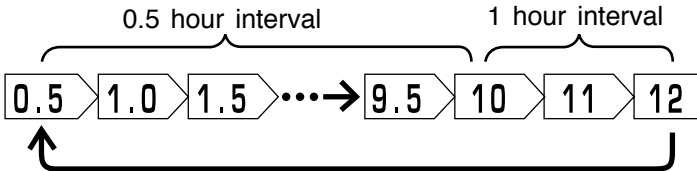

- The value change quicker if you keep pressing the button.

### 2 Press the ○ (SET) button

- OFF TIMER is reserved.
- The ☐ (OFF) Mark starts lighting instead of blinking.

## ON Timer Reservation

### 1 ⌚ ON TIMER setting

- Select the ON TIMER by pressing the ⌚ (ON) Button.
- At the beginning of setting, timer is set to 6 hours.
- Setting timer will change according to the below sequence.

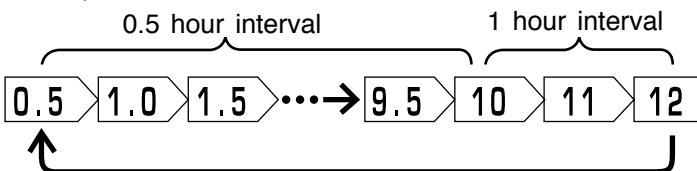

- The value change quicker if you keep pressing the button.

### 2 Press the ○ (SET) button

- ON TIMER is reserved.
- The □ (ON) Mark starts lighting instead of blinking.

## CANCELLATION of Timer Reservation

### 1 Press the ○ (CANCEL) button

- As the timer settings are stored in remote controller memory, you only have to press the ○ (SET) button in order to use the same setting next time.

■ Operation stop at setting timer

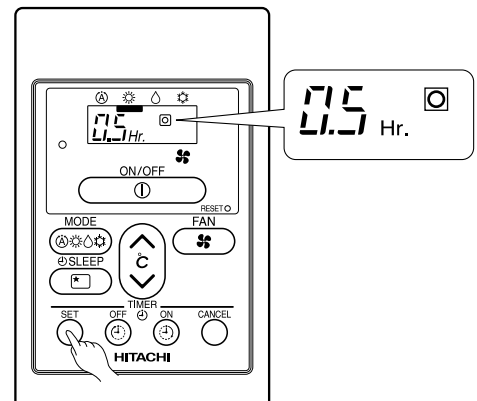
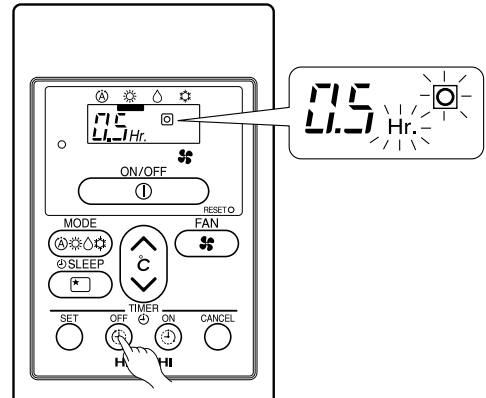

■ Operation will start for setting temperature at setting timer (The starting time may different depend on the room temperature and set temperature).

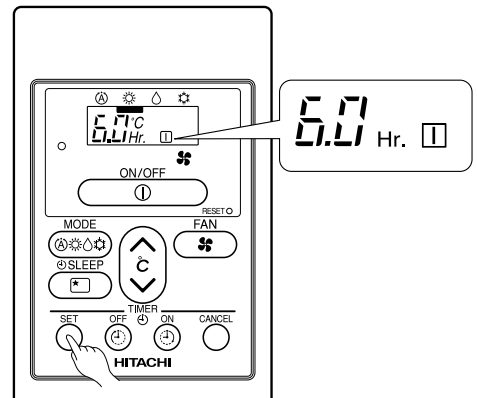
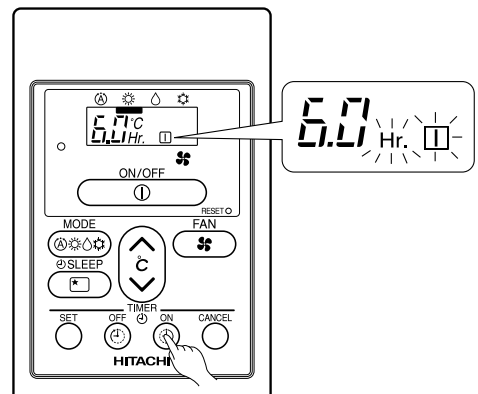

# HOW TO SET THE SLEEP TIMER

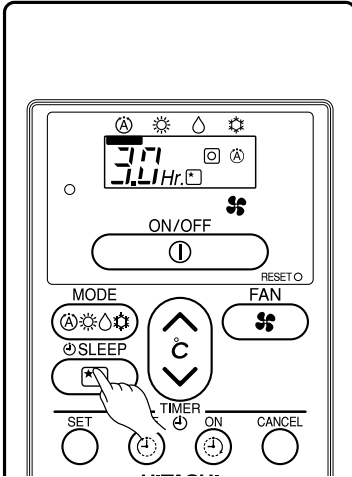

Example: Setting 3 hours sleep timer.

Mode	Indication
Sleep timer	

**Sleep Timer:** The device will continue working for the designated number of hours and then turn off.  
 Press the SLEEP button.  
 The timer information will be displayed on the remote controller.

**How to Cancel Reservation**

Press the ○ (CANCEL) button. The ◻ and ★ (RESERVED) sign goes out.

## Explanation of the sleep timer

The device will control the FAN SPEED and room temperature automatically so as to be quiet and good for people's health.

- NOTE**
- If you set the sleep timer after the off or on-timer has been set, the sleep timer becomes effective instead of the off or on-timer set earlier.
  - You can not set other timer during sleep timer operation.
  - After sleep timer time is up and when press sleep button again, the sleep timer will be set as last setting.
  - Sleep timer effective only once.

# INSTALLATION OF WIRED REMOTE CONTROLLER

- (a) Connection to the electrical box;
- Remove the cover of electric box
  - Connect the connector of wired remote controller to CN1102 of electrical board
  - Assemble back the cover of electrical box
- (b) Wiring installation for wired remote controller (2 methods);
- Wired remote controller casing can be opened by pressing the slots with minus screw driver (see below diagram)

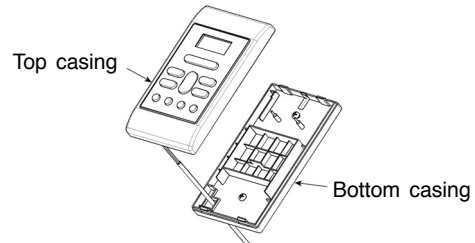
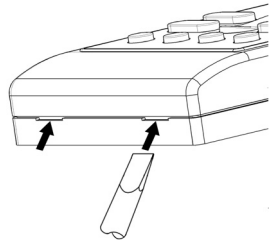

- Decide the fixing location of remote controller so that the length of wire shall be within 5 meters.

 <b>CAUTION</b>	<ul style="list-style-type: none"> <li>● Do not cut the provided wire. Excess wire should be properly wound and fitted at safe place.</li> <li>● Do not join the wire with additional wire.</li> </ul>
---	--

## Wiring installation illustrations

Wall recessed wiring installation (Supplied)	Inside top wiring installation (Alternative)
<p>1. When connecting the wires via the wall's recessed slot;</p> <ul style="list-style-type: none"> <li>● Fix the bottom casing to the wall by provided screw.</li> <li>● Assemble the top casing to the fixed bottom casing.</li> </ul> <p>(Refer to the illustration below for detail installation)</p>	<p>2. When the wires to be connected from the inside top portion of top casing;</p> <ul style="list-style-type: none"> <li>● Break off a perforated aperture located at the top portion of the bottom casing by nipper. Smoothen the aperture by cutter.</li> <li>Fix the bottom casing to the wall by provided screw.</li> <li>● Connect the wires to the lead wires connector.</li> <li>● Mount the wires through the provided slot on top casing.</li> <li>● Assemble the top casing to the fixed bottom casing</li> </ul> <p>(Refer to the illustration below for detail installation)</p>

# PREPARATION BEFORE OPERATION

## ■ To install the batteries

1. Slide the cover to take it off.
2. Install two dry batteries AAA.LR03 (alkaline).  
The direction of the batteries should match the marks in the case.
3. Replace the cover at its original position.

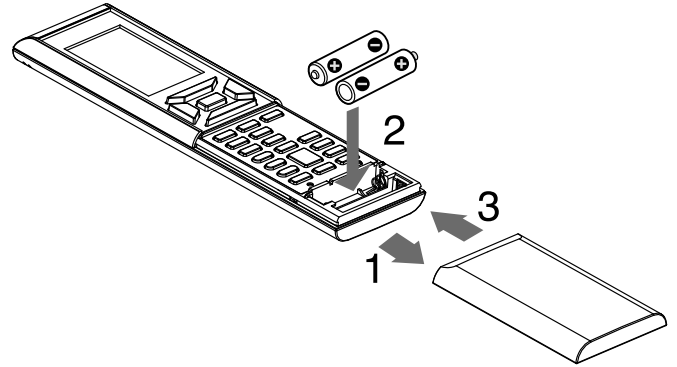

## ■ To fix the remote controller holder to the wall

1. Choose a place from where the signals can reach the unit.
2. Fix the remote controller holder to a wall, a pillar or similar location with the provided screws.
3. Place the remote controller in the remote controller holder.

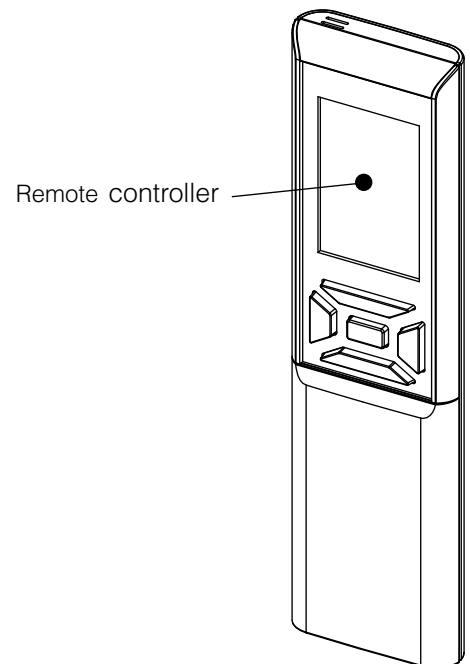

### NOTE

#### Notes on batteries

- When replacing the batteries, use batteries of the same type, and replace both old batteries together.
- When the system is not used for a long time, take the batteries out.
- The batteries will last for approximately 1 year. However, if the remote controller display begins to fade and degradation of reception performance occurs within a year, replace both batteries with new size AAA.LR03 (alkaline).
- The usable period of the batteries may be short depending on the manufactured date of the air conditioner.

#### Notes on the remote controller

- Never expose the remote controller to direct sunlight.
- Dust on the signal transmitter or receiver will reduce the sensitivity. Wipe off dust with soft cloth.
- Signal communication may be disabled if an electronic-starter-type fluorescent lamp (such as inverter-type lamps) is in the room. Consult the shop if that is the case.
- If the remote controller signals happen to operate another appliance, move that appliance to somewhere else, or consult the service shop.
- When the remote controller is not in use, please close the slide cover to prevent failure.

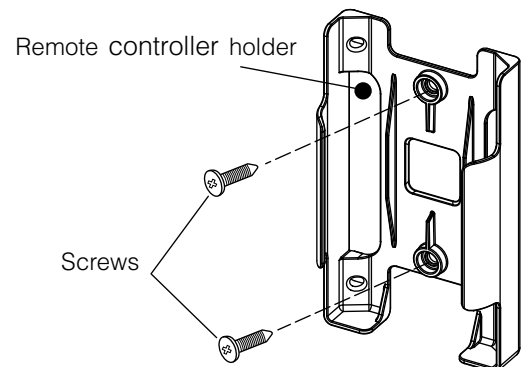

# PREPARATION BEFORE OPERATION

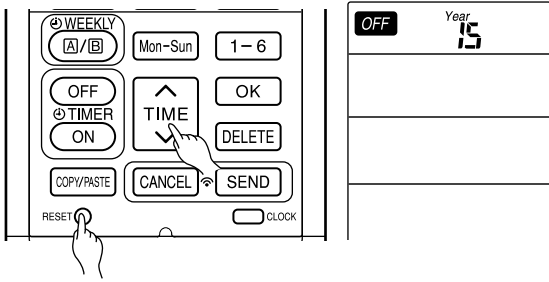

## ■ To set calendar and clock

1. Press **RESET** (RESET) button when first time setting. "Year" blinks.
  2. Press **TIME** (TIME) button to set the current year.
  3. Press **CLOCK** (CLOCK) button. "Day" and "Month" blink.
  4. Press **TIME** (TIME) button to set the current day and month.
  5. Press **CLOCK** (CLOCK) button. "CLOCK" blinks.
  6. Press **TIME** (TIME) button to set the clock to the current time.
  7. Press **CLOCK** (CLOCK) button.
- Calendar and clock are set.

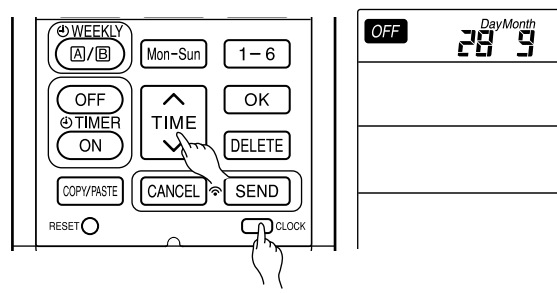

To modify the calendar and clock, press **CLOCK** (CLOCK) button.  
Then follow steps 1 to 7.

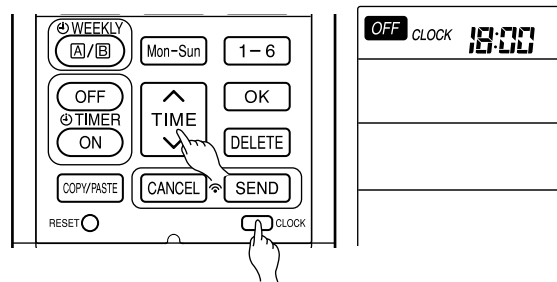

Calendar and clock need to be set again after changing batteries.

- After changing the batteries,
1. Press **RESET** (RESET) button.
  2. Direct remote controller towards indoor unit and press **INFO** (INFO) button.
  3. The calendar and clock from indoor unit will be transmitted.

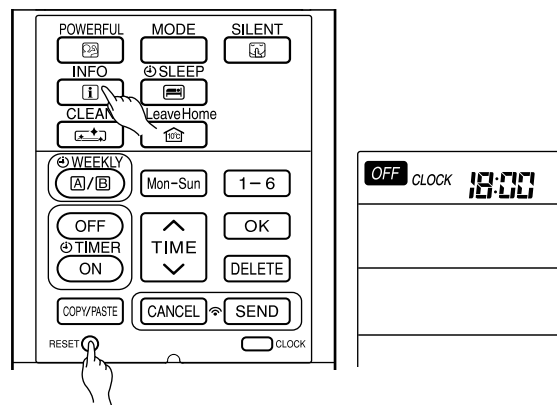

- Calendar and clock will not be transmitted from indoor unit when the following occurs:
  - When there is a power failure.
  - When breaker is OFF by user (unit is not in STANDBY MODE).

### NOTE

- Note on setting the calendar and clock.
- If the calendar and clock are not set, the ON-timer, OFF-timer and Weekly Timer cannot be set.
  - If the calendar and clock are not set correctly, the ON-timer, OFF-timer and Weekly Timer will not operate correctly.
  - When the ON-timer, OFF-timer and Weekly Timer are set, the calendar and clock cannot be changed. If there is a need to change the calendar and clock, ON-timer, OFF-timer and Weekly Timer need to be cancelled.

# NAMES AND FUNCTIONS OF REMOTE CONTROLLER

## REMOTE CONTROLLER

- This controls the operation of the indoor unit. The range of control is about 7 meters. If indoor lighting is controlled electronically, the range of control may be shorter.  
This unit can be fixed on a wall using the fixture provided. Before fixing it, make sure the indoor unit can be controlled from the remote controller.
- Handle the remote controller with care. Dropping it or getting it wet may compromise its signal transmission capability.
- After new batteries are inserted into the remote controller, the unit will initially require approximately 10 seconds to respond to commands and operate.
- When remote controller is not in use for about 3 minutes during OFF condition, indicated by **OFF** on the display, the LCD will turn off.
- During clock setting, the LCD will turn off about 10 minutes later if the remote controller is not in use.
- When pressing any button, the LCD will turn on.
- The LCD will not turn off during TIMER setting.

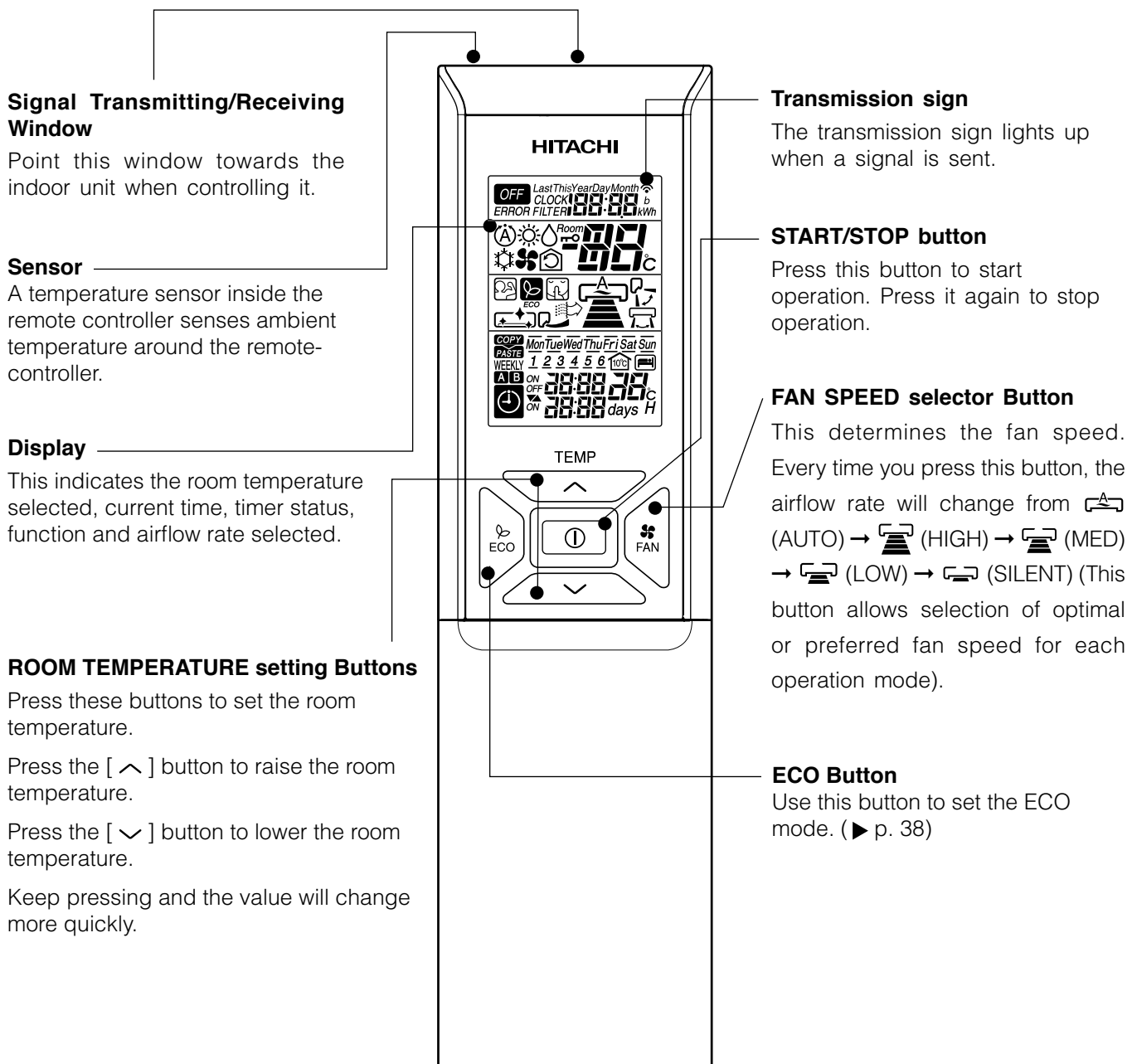

# NAMES AND FUNCTIONS OF REMOTE CONTROLLER

## POWERFUL Button

Use this button to set the POWERFUL mode. (▶ p. 36)

## INFORMATION Button

(▶ p. 50)

## ONE TOUCH CLEAN Button

(▶ p. 40)

## LEAVE HOME Button

(▶ p. 39)

## ECO SLEEP TIMER Button

Use this button to set the ECO sleep timer. (▶ p. 42)

## ON / OFF TIMER setting Buttons

(▶ p. 41)

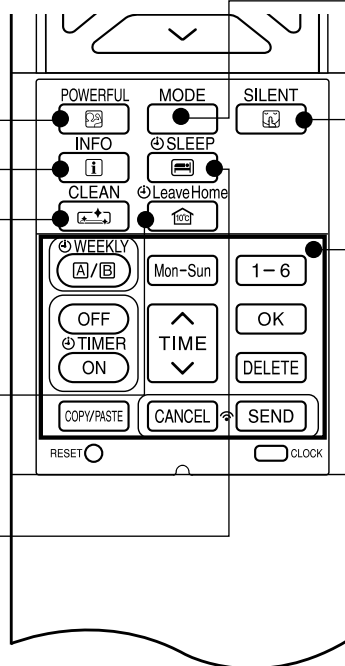

## MODE selector Button

Use this button to select the operating mode. Every time you press this button, the mode will change from (AUTO) → (HEAT) → (DEHUMIDIFY) → (COOL) and → (FAN) cyclically.

## SILENT Button

Use this button to set the SILENT mode. (▶ p. 37)

## WEEKLY TIMER setting Buttons

(▶ p. 44)

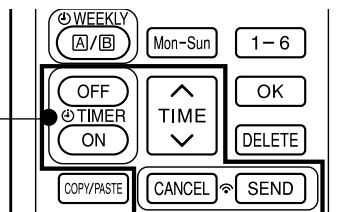

	MODE SELECTOR
	AUTO
	HEAT
	DEHUMIDIFY
	COOL
	FAN
	FAN SPEED
	AUTO SILENT LOW MED HIGH
	START / STOP

	ECO
	FAN
	POWERFUL
	SILENT
	INFO
	SLEEP TIMER
	LEAVE HOME
	CLEAN
Mon-Sun	DAY
1-6	PROGRAM NO.

	ON / OFF TIMER
	ON / OFF TIMER
	TIME
	OK
	DELETE
	COPY / PASTE
	CANCEL
	SEND
	CLOCK

## Precautions for Use

- Do not put the remote controller in the following places.
  - Under direct sunlight.
  - In the vicinity of a heater.
- Handle the remote controller carefully. Do not drop it on the floor, and protect it from water.
- Once the outdoor unit stops, it will not restart for about 3 minutes (unless you turn the power switch off and on or unplug the power cord and plug it in again). This is to protect the device and does not indicate a failure.
- If you press the MODE selector button during operation, the device may stop for about 3 minutes for protection.

# VARIOUS FUNCTIONS

## Auto Restart Control

- If there is a power failure, operation will be automatically restarted when the power is resumed with previous operation mode and airflow direction.  
(As the operation is not stopped by remote controller.)
- If you intend not to continue the operation when the power is resumed, switch off the power supply.  
When you switch on the circuit breaker, the operation will be automatically restarted with previous operation mode and airflow direction.

Note: 1. If you do not require Auto Restart Control, please consult your sales agent.  
2. Auto Restart Control is not available when Timer or Sleep Timer mode is set.

## AUTOMATIC OPERATION

The device will automatically determine the mode of operation, HEAT or COOL depending on the current room temperature. The selected mode of operation will change when the room temperature varies. However, the mode of operation will not change when indoor unit is connected to multi type outdoor unit.

**1** Press the MODE selector button so that the display indicates the (AUTO) mode of operation.

- When AUTO has been selected, the device will automatically determine the mode of operation, HEAT or COOL depending on the current room temperature. However the mode of operation will not change when indoor unit is connected to multi type outdoor unit.
- If the mode automatically selected by the unit is not satisfactory, manually change the mode setting (HEAT, DEHUMIDIFY, COOL or FAN).

**2** Set the desired FAN SPEED with the (FAN SPEED) button (the display indicates the setting).

**3** Set the desired room temperature with the TEMPERATURE buttons (the display indicates the setting).  
The temperature setting and the actual room temperature may vary depending on conditions.  
Temperature range can be set between 16°C and 32°C.

**START STOP** Press the (START/STOP) button.  
Operation starts with a beep.  
Press the button again to stop operation.

- As the settings are stored in the memory of the remote controller, you only have to press the (START/STOP) button next time.

Press the (FAN SPEED) button to select AUTO, HIGH, MED, LOW or SILENT.



# HEATING OPERATION

- Use the device for heating when the outdoor temperature is under 21°C. When it is too warm (over 21°C), the heating function may not work in order to protect the device.
- In order to maintain reliability of the device, please use this device when outdoor temperature is above -15°C.

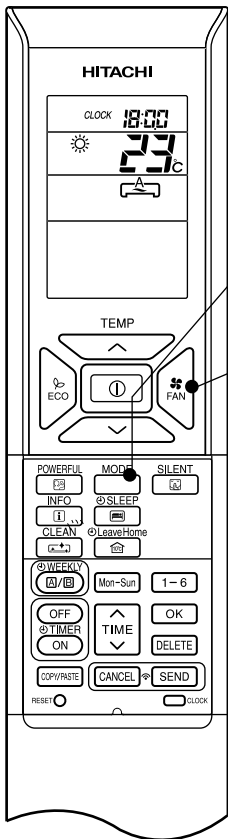

**1**

Press the MODE selector button so that the display indicates  (HEAT).

**2**

Set the desired FAN SPEED with the  (FAN SPEED) button (the display indicates the setting).

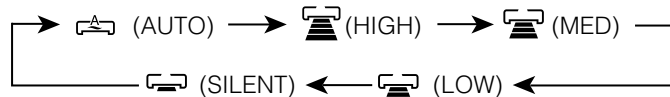

**3**

Set the desired room temperature with the TEMPERATURE buttons (the display indicates the setting).

The temperature setting and the actual room temperature may vary depending on conditions.

Temperature range can be set between 16°C and 32°C.

**START STOP**

Press the  (START/STOP) button. Heating operation starts with a beep. Press the button again to stop operation.

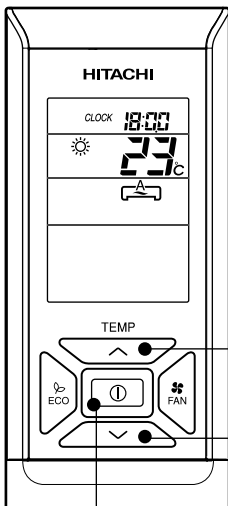

- As the settings are stored in the memory of the remote controller, you only have to press the  (START/STOP) button next time.
- During AUTO fan, the fan speed automatically changes as below:
  - When the difference between room temperature and setting temperature is large, fan starts to run at HI speed.
  - After room temperature reaches the preset temperature, fan speed will be changed to lower speed to obtain optimum room temperature condition for natural healthy heating.

## Defrosting

Defrosting will be performed about once an hour when frost forms on the heat exchange of the outdoor unit, for 5~10 minutes each time.

During defrosting operation, the operation lamp blinks in a cycle of 3 seconds on and 0.5 second off.

The maximum time for defrosting is 20 minutes.

However, if the indoor unit is connected to multi type outdoor unit, the maximum time for defrosting is 15 minutes.

(If the piping length used is longer than usual, frost is likely to form.)

# DEHUMIDIFYING OPERATION

Use the device for dehumidifying when the room temperature is over 16°C.  
When it is under 15°C, the dehumidifying function will not work.

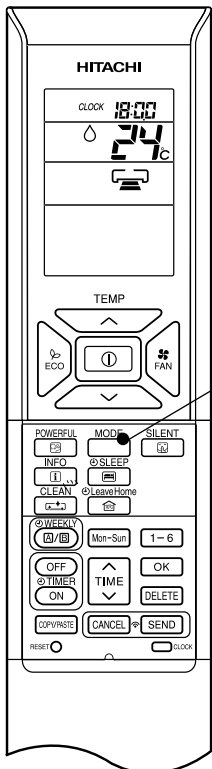

1

Press the MODE selector button so that the display indicates ◊ (DEHUMIDIFY).  
The fan speed is set at LOW.  
Press  (FAN SPEED) button to select SILENT or LOW fan speed.

2

Set the desired room temperature with the ROOM TEMPERATURE setting buttons (the display indicates the setting).

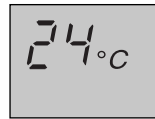

The range of 20-26°C is recommended as the room temperature for dehumidifying.  
Temperature range can be set between 16°C and 32°C.

**START  
STOP**

Press the  (START/STOP) button. Dehumidifying operation starts with a beep. Press the button again to stop operation.

- As the settings are stored in the memory of the remote controller, you only have to press the  (START/STOP) button next time.

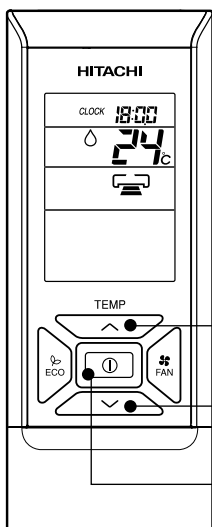

## ■ Dehumidifying Function

- When the room temperature is higher than the temperature setting: The device will dehumidify the room, reducing the room temperature to the preset level.  
When the room temperature is lower than the temperature setting: Dehumidifying will be performed at the temperature setting slightly lower than the current room temperature, regardless of the temperature setting.
- The preset room temperature may not be reached depending on the number of people present in the room or other room conditions.

# COOLING OPERATION

Use the device for cooling when the outdoor temperature is -10~ 43°C.  
If indoors humidity is very high (80%), some dew may form on the air outlet grille of the indoor unit.

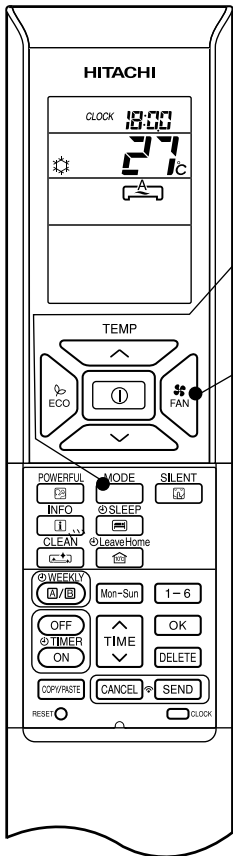

**1** Press the MODE selector button so that the display indicates (COOL).

Set the desired FAN SPEED with the (FAN SPEED) button (the display indicates the setting).

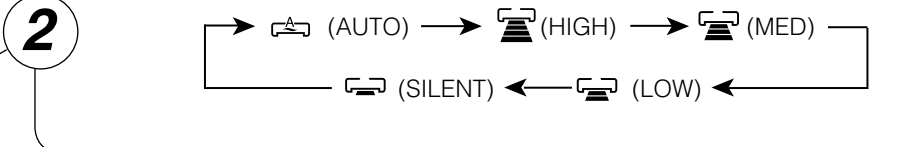

**3** Set the desired room temperature with the TEMPERATURE buttons (the display indicates the setting).  
The temperature setting and the actual room temperature may vary depending on conditions.  
Temperature range can be set between 16°C and 32°C.

**START STOP**  
Press the (START/STOP) button. Cooling operation starts with a beep. Press the button again to stop operation. The cooling function does not start if the temperature setting is higher than the current room temperature (even though the (OPERATION) lamp lights). The cooling function will start as soon as user set the temperature below the current room temperature.

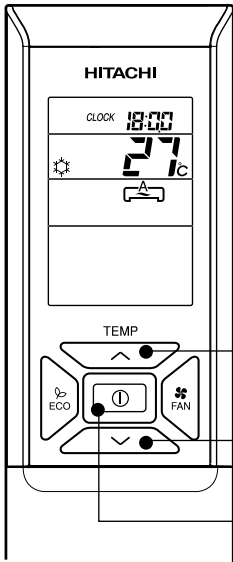

- As the settings are stored in the memory of the remote controller, you only have to press the (START/STOP) button next time.
- During AUTO fan, the fan speed automatically changes as below:
  - When the difference between room temperature and setting temperature is large, fan starts to run at HI speed.
  - After room temperature reaches the preset temperature, fan speed will be changed to lower speed to obtain optimum room temperature condition for natural healthy cooling.

# FAN OPERATION

User can use the device simply as an air circulator.

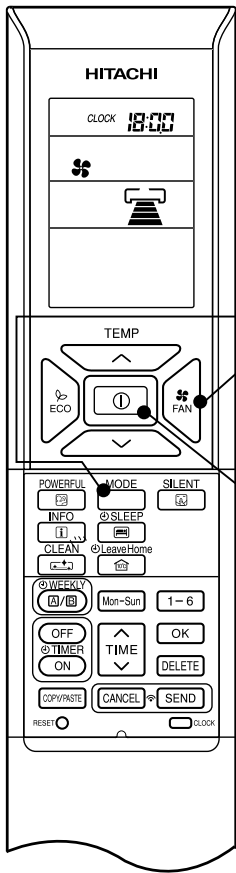

**1**

Press the MODE selector so that the display indicates  (FAN).

**2**

Set the desired FAN SPEED with the  (FAN SPEED) button (the display indicates the setting).

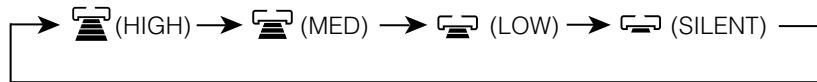

**START  
STOP**

Press the  (START/STOP) button. Fan operation starts with a beep. Press the button again to stop operation.



# POWERFUL OPERATION

- By pressing  (POWERFUL) button during AUTO, HEATING, DEHUMIDIFYING, COOLING or FAN operation, the air conditioner performs at the maximum power.
- During POWERFUL operation, cooler or warmer air will be blown out from indoor unit for COOLING or HEATING operation respectively.

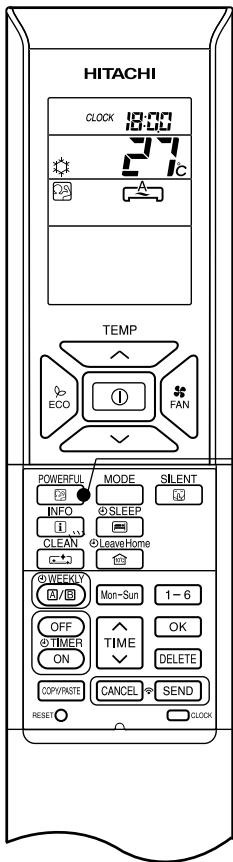



## ■ To start POWERFUL operation

- Press  (POWERFUL) button during operation.

“” is displayed on the LCD.

POWERFUL operation ends in 20 minutes. Then the system automatically operates with the previous settings used before POWERFUL operation.

## ■ To cancel POWERFUL operation

- Press the  (START/STOP) button. Or
- Press  (POWERFUL) button again.

POWERFUL operation stops.

“” disappears from the LCD.

## NOTE

- When SLEEP mode, ECO mode, SILENT mode or LEAVE HOME mode is selected, POWERFUL operation is cancelled.
- During POWERFUL operation, capacity of the air conditioner will not increase
  - if the air conditioner is already running at maximum capacity.
  - just before defrost operation (when the air conditioner is running in HEATING operation).
- After auto restart, POWERFUL operation is cancelled and previous operation shall start.
- For multi model connections, POWERFUL operation may not function depending on operation conditions.

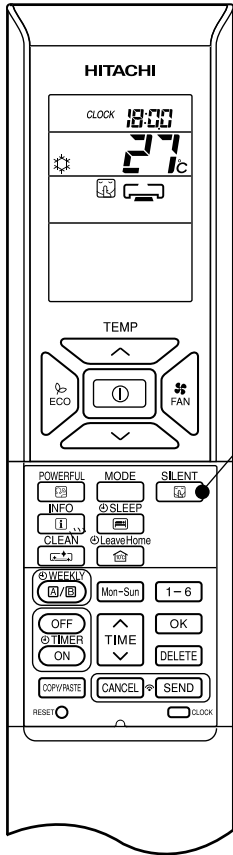

## SILENT OPERATION

- By pressing  (SILENT) button during AUTO, HEATING, DEHUMIDIFYING, COOLING or FAN operation, the fan speed will change to ultra slow.





### ■ To start SILENT operation

1

- Press  (SILENT) button during operation.  
“” is displayed on the LCD. Fan speed will be ultra slow.

### ■ To cancel SILENT operation



- Press  (START/STOP) button. Or
- Press  (SILENT) button again or  (FAN SPEED) button.

Fan speed will return to previous fan speed before SILENT operation starts.

SILENT operation stops.

“” disappears from the LCD.

### NOTE

- When POWERFUL operation is selected, SILENT operation is cancelled. Fan speed will return to previous fan speed before SILENT operation.
- After auto restart, SILENT operation is cancelled. Fan speed will return to previous fan speed before SILENT operation.
- During any operation with fan speed  (SILENT), if press  (SILENT) button, fan speed will not change.



# ECO OPERATION

ECO operation is an energy saving function by changing set temperature automatically and by limiting the maximum power consumption value.

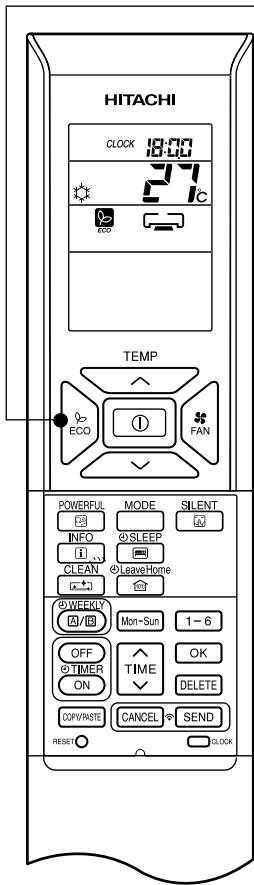

1

- By pressing the  (ECO) button during AUTO, HEATING, DEHUMIDIFYING or COOLING operation, the air conditioner performs the "ECO" operation.

## ■ To start ECO operation



- Press  (ECO) button during operation.

“” is displayed on the LCD.

A beep sound is emitted from indoor unit.

Energy saving operation will start by changing the set temperature higher or lower automatically and reducing operation power consumption. This function may vary based on the connected outdoor unit.

## ■ To cancel ECO operation

- Press  (START/STOP) button. Or
- Press  (ECO) button again.

“” disappears from the LCD.

A beep sound is emitted from indoor unit.

## NOTE

- ECO function will not be effective when power consumption is low.
- By pressing (POWERFUL) button, ECO operation is cancelled.
- After auto restart, ECO operation is cancelled and previous operation mode shall start.
- For multi model connections, energy saving operation shall start only by changing set temperature higher or lower automatically. However, effectiveness of ECO depends on operation conditions.

# 10°C LEAVE HOME (LH) OPERATION

Prevent the room temperature from falling too much when no one is at home. The initial setting temperature is 10°C and the temperature range can be set between 10°C and 16°C.

This operation is able to operate by "Continuous operation" or "Day timer operation". Please use "Day timer operation" to set the number of days up to 99 days.

## Continuous operation

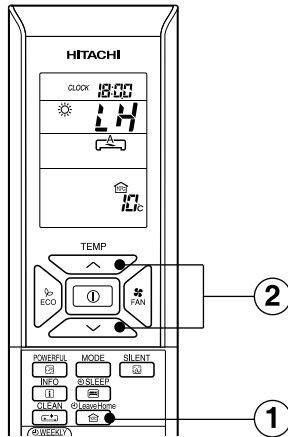

## Day timer operation

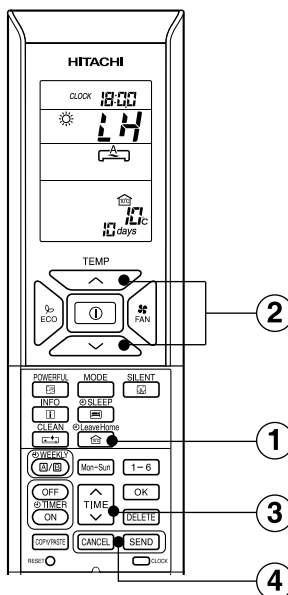

## To start LEAVE HOME operation

### Option 1. Continuous operation.

- ① Press (LEAVE HOME) button during stop or operation. Room temperature is set at 10°C and heating operation starts.
- ② Set the desired room temperature with the TEMPERATURE buttons. Temperature range can be set between 10°C and 16°C.  
, "**LH**", "", "", "SET TEMPERATURE" is displayed on the LCD.

### Option 2. Day timer operation.

Press (LEAVE HOME) button during stop or operation. Room temperature is set at 10°C and heating operation starts.

Set the desired room temperature with the TEMPERATURE buttons. Temperature range can be set between 10°C and 16°C.

, "**LH**", "", "", "SET TEMPERATURE" is displayed on the LCD.

- ③ Set number of operation days (1 to 99 days), if needed.

Press (TIME) button to select number of days.

Number of days blink.

\* Press " (UP)" or " (DOWN)" to set number of days from 1 day to 99 days.

\* Number of day is counted when clock indicates 0:00.

- ④ Press (SEND) button to confirm number of operation days. Display for number of operation days will stop blinking.

Press (CANCEL) button to reset number of operation days or to have continuous operation.

## To cancel LEAVE HOME operation

- Press (START/STOP) button. Or
- Press (LEAVE HOME) button again. Return to previous operation mode. Or
- Change to other operation mode by pressing (MODE) button.

## NOTE

- After reaching the set number of operation days for Leave Home or by pressing the (Leave Home) button again, the unit will operate in previous mode.
- During Leave Home operation, fan speed and horizontal air deflector position cannot be changed.
- By pressing (Leave Home) button, implementation of Weekly Timer or Once Timer is cancelled.
- In case of power supply shut down, after autorestart, all setting for number of days operation will be reset and unit shall be in continuous operation.
- POWERFUL, SILENT and ECO operations are not applicable during Leave Home operation.
- For multi connection
  - FAN/COOLING/DEHUMIDIFYING and Leave Home cannot operate at the same time. The first-run unit has a priority and other units in different mode will be in standby mode.
  - Heating operation can be used with Leave Home.
  - When two or more rooms are set to operate Leave Home, the temperature set by Leave Home may not be reached. It also depends on outdoor temperature.





## CLEAN (ONE TOUCH CLEAN) OPERATION

Drying indoor heat exchanger after cooling operation to prevent mildew.

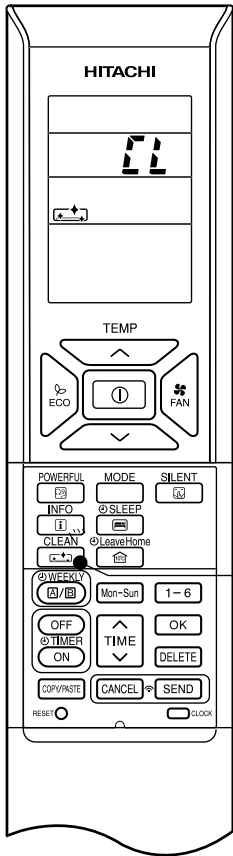



### ■ To start CLEAN operation

- Press  (CLEAN) button when unit is OFF.  
Total time taken for One Touch Clean operation is 60 minutes. During this operation, HEATING or FAN operation shall operate.

During one touch clean, operation lamp is blinking.

“”, “” is displayed on the LCD.

### ■ To cancel CLEAN operation

- Press  (START/STOP) button. Or
- Press  (CLEAN) button again.

### NOTE

- When CLEAN operation finish, unit will switch OFF automatically.
- If Weekly Timer or Once Timer is set, there is a need to cancel those timer before operating CLEAN function.
- For multi model connections, when pressing  (CLEAN) button, operation is limited to FAN operation.
- For multi connections, when one room operates CLEAN operation first, other rooms can operate COOLING, DEHUMIDIFYING or FAN operation. However, when other rooms need to operate HEATING operation, air conditioner will be in STANDBY mode. After CLEAN operation finish, HEATING operation will start.



# ONCE TIMER (ON/OFF TIMER) OPERATION

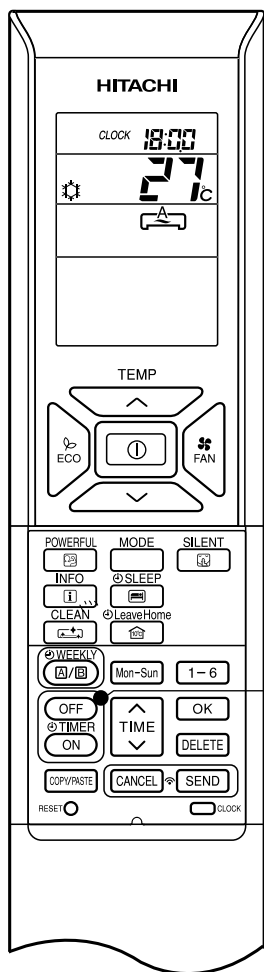

## OFF TIMER

The device can be set to turn off at a preset time.

1. Press (OFF-TIMER) button. and **0:00** blink on the display.
2. Set the "turn-off time" with (TIME) button.
3. After setting, direct the remote controller towards the indoor and press (SEND) button.  
 and "set time" lights up instead of blinking.

A beep sound emitted from indoor unit and the (TIMER) lamp on the indoor unit lights up.

## ON TIMER

The device will turn on at a designated time.

1. Press (ON-TIMER) button. and **0:00** blink on the display.
2. Set the "turn-on time" with (TIME) button.
3. After setting, direct the remote controller towards the indoor and press (SEND) button.  
 and "set time" light up instead of blinking.

A beep sound emitted from indoor unit and the (TIMER) lamp on the indoor unit lights up.

## ON/OFF TIMER

- The device will turn on (off) and off (on) at the designated time.
- The switching occurs first at the preset time that comes earlier.
- The arrow mark appears on the display to indicate the sequence of switching operations.

1. Press (OFF-TIMER) button so that and **0:00** blink on the display.
2. Set the "turn-off" time with (TIME) button. After setting, direct the remote controller towards the indoor and press (SEND) button.
3. Press (ON-TIMER) button so that and set "turn-off" time light up. The and **0:00** blink.
4. Set the "turn-on" time with (TIME) button.
5. After setting, direct the remote controller towards the indoor and press (SEND) button.  
 and set "turn-on" time light up instead of blinking.

A beep sound emitted from indoor unit and the (TIMER) lamp on the indoor unit lights up.

- The timer may be used in three ways: OFF-timer, ON-timer and ON/OFF (OFF/ON)-timer. Set the current time first because it serves as a reference.

## ■ To cancel Reservation

- Point the signal window of the remote controller towards the indoor unit and press (CANCEL) button.  
 and "ON or OFF set time" goes out with a beep and the (TIMER) lamp on the indoor unit turns off.

## NOTE

- User can set only one of the OFF-timer, ON-timer or ON/OFF-timer.
- If WEEKLY TIMER already set, by setting the ONCE TIMER, ONCE TIMER operation is prioritized. When ONCE TIMER operation is complete, WEEKLY TIMER operation will be activated.



# ECO SLEEP TIMER OPERATION

The timer can be set up to a duration of 7 hours.

By pressing (SLEEP) button during AUTO, HEATING, DEHUMIDIFYING, COOLING or FAN operation, the unit shifts the room temperature and reduces the fan speed. It results in energy saving.

Set the current time first before operating the ECO SLEEP TIMER operation.

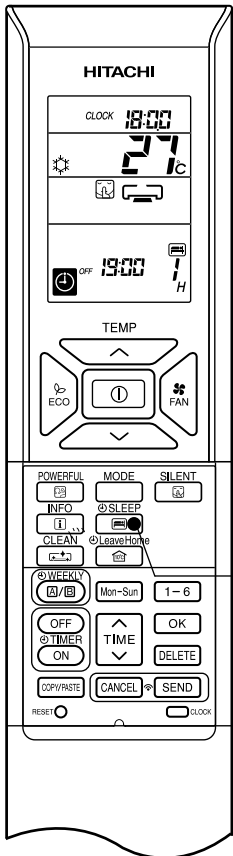

## To start ECO SLEEP TIMER operation

Press (SLEEP) button during operation.

- “”, “”, “”, “OFF”, off time, “” and number of hour are displayed on the remote controller display.
- During ECO SLEEP TIMER operation, fan speed will be ultra slow.
- A beep sound emitted from indoor unit and the (TIMER) lamp on the indoor unit lights up.

Pressing (SLEEP) button repeatedly, the number of hours will change as below:

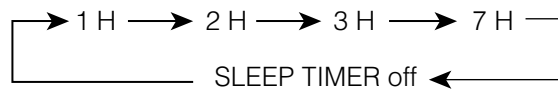

- During ECO SLEEP TIMER operation, air conditioner will continue to operate for the designated number of hours and then turn off.
- When the ECO SLEEP TIMER has been set, the display on the remote controller indicates the turn off time.



Example: If ECO SLEEP TIMER is set for 1 hour at 18:00, the switch off time will be at 19:00.

## To cancel ECO SLEEP TIMER operation

Press (START/STOP) button.

- Room air conditioner will switch off.

Press (SLEEP) button again until “”, “”, “”, off time, “” and number of hour disappear from the remote controller display.

Press (CANCEL) button.

- A beep sound emitted from indoor unit and the (TIMER) lamp on the indoor unit turns off.
- SLEEP TIMER operation is cancelled.



# ECO SLEEP TIMER OPERATION

## To set ECO SLEEP TIMER and ON TIMER

The air conditioner will be turned off by ECO SLEEP TIMER and turned on by ON TIMER.

1. Set the ON TIMER.
2. Press (SLEEP) button and set ECO SLEEP TIMER.



Example:  
In this case, air conditioner will turn off in 2 hours (at 1:38) and it will be turned on at 6:00 the next morning.

## To cancel ECO SLEEP TIMER and ON TIMER operation

Direct the remote controller towards the indoor unit and press (CANCEL) button.

- “”, “”, “”, “OFF”, off time, “”, number of hour, “ON” and ON TIMER set time disappear from the remote controller display.
- A beep sound emitted from indoor unit and the (TIMER) lamp on the indoor unit turns off.
- ECO SLEEP TIMER and ON TIMER reservations are cancelled.

30 minutes after setting ECO SLEEP TIMER, outdoor fan speed will be reduced to lower the noise level and to have comfort operation.

1 hour after setting ECO SLEEP TIMER, set temperature will be slightly shifted. Amount of temperature shifted depends on type of air conditioner.

These automatic operation changes contribute to energy saving without losing comfort.

The level of energy consumption depends on outside temperature, room temperature, set temperature or air conditioner type.

Cooling operation [diagram representation for illustrative purpose only]

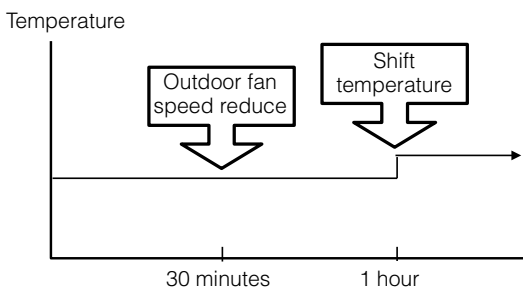

Heating operation [diagram representation for illustrative purpose only]

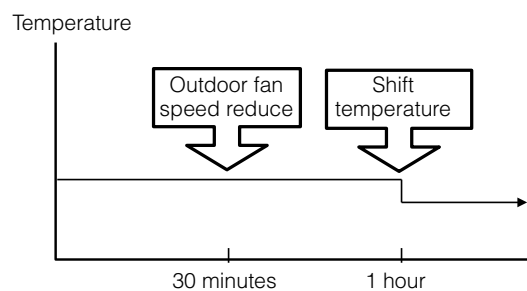

### NOTE

- If ECO SLEEP TIMER is set when OFF TIMER or ON/OFF TIMER has been set earlier, the ECO SLEEP TIMER becomes effective instead of the OFF TIMER or ON/OFF TIMER.



# WEEKLY TIMER OPERATION

- It is possible to select Mode A or Mode B. For each mode, up to 6 programs can be set per day. In total, a maximum of 42 programs can be set for a week for each mode.
- If calendar and clock are not set, the reservation setting for WEEKLY TIMER cannot be set.
- If calendar and clock are not set correctly, WEEKLY TIMER will not operate correctly.
- Reservation for calendar and clock shall be set first before operating WEEKLY TIMER.

**Step 1: Set the reservation schedule to the remote controller. Send the registered reservation to indoor unit and then operate.**

**Step 2: Select Mode A or Mode B and activate or deactivate WEEKLY TIMER .**

**Step 3: Copy and cancel the reservation schedule.**

## Step 1 : Set reservation schedule to the remote controller. Send the registered reservation to indoor unit and then operate.

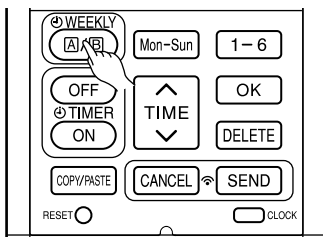

1

2

### How to set a WEEKLY TIMER.

#### 1. Select Mode A or Mode B

Press (WEEKLY) button. WEEKLY lights up. **A** and blink on the display. (Mode A is selected).

Press (WEEKLY) button again, **B** and blink on the display. (Mode B is selected).

- If no reservation has been made, ON/OFF, --:-- , appear.
- If reservation has been made, ON/OFF, --:-- , will not appear.

#### 2. Set a program

Press (WEEKLY) button for about 3 seconds. The selection mode can be changed.

, day: Mon, program no. : 1, ON/OFF, setting time and setting temperature blink on the display.

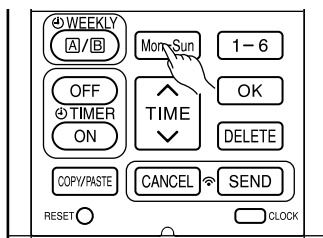

3

#### 3. Select the desired day of the week

Press (DAY) button.

The day changes from Mon → Tue → Wed → Thu → Fri → Sat → Sun → Mon, Tue, Wed, Thu, Fri, Sat, Sun [Full days] → Mon, Tue, Wed, Thu, Fri [weekday] → Sat, Sun [weekend] → Mon → Tue .....

Select [Full days] for daily reservation.

Select [weekday] for Monday to Friday reservation.

Select [weekend] for Saturday and Sunday reservation.

- After reservation has been set, it is easy to check and edit at the same time.

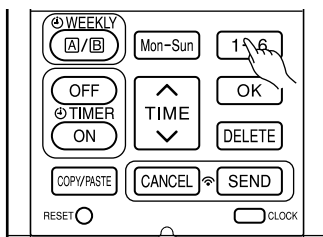

4

#### 4. Press button to select a program number.

The number changes from 1 → 2 → 3 → 4 → 5 → 6 → 1 → 2 .....

- If program number has been set, follow above in order to make changes.



# WEEKLY TIMER OPERATION

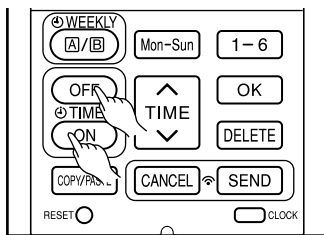

5

5. Press (ON-OFF TIMER) button to select ON TIMER or OFF TIMER reservation.

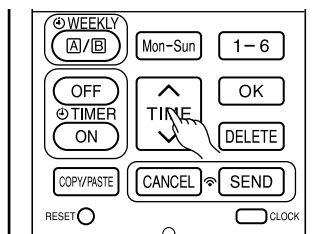

6

6. Press (TIME) button to set time reservation.

7. Press (TEMP  $\wedge$  or  $\vee$ ) button to set temperature reservation.

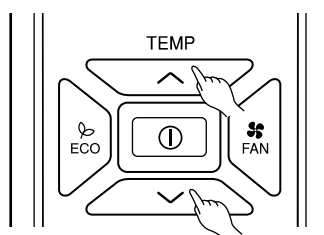

7

8. Press (OK) button. The reservations are set. Day, program number, ON reservation, setting temperature will light up. will be continuously blinks. If reservation is not complete, settings will not be stored in memory.

To continue with the reservation, press buttons. Follow step 3 to 8 for reservation.

9. After all the reservations have been set, press (SEND) button while directing the remote controller towards the indoor unit for about 3 seconds. Timer lamp on the indoor unit will blink rapidly. After beep sound emitted from indoor unit, TIMER lamp will light up.

### Please ensure that the TIMER lamp lights up.

This indicates that the reservation has been stored in the indoor unit and Timer function has been completed.

The reservation contents will appear on the remote controller display.

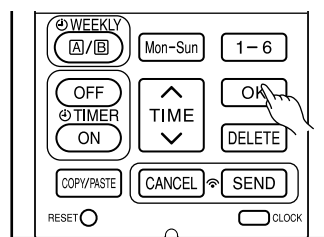

8

- If TIMER lamp on the indoor unit does not light up, press (SEND) button while directing the remote controller towards the indoor unit for about 3 seconds.

- **CAUTION !** Do not press (CANCEL) button during reservation setting because this will result in all reservation contents to be lost.

- The reservation contents will not stored in the indoor unit until (SEND) button has been pressed.

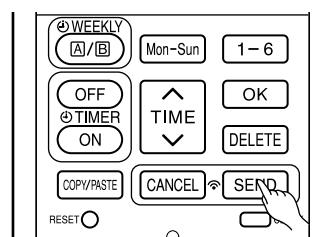

9

## NOTE

- Up to 6 programs can be set per day. Setting ON TIMER or OFF TIMER for each program number can be at random. When pressing (SEND) button, the set ON TIMER or OFF TIMER for each program number will automatically arranged so that program number 1 shall have the earliest time and program number 6 shall have the latest time. If the setting time is the same, Priority will be given to the latest reservation contents.
- **CAUTION !** If the remote controller is left idle and (SEND) button is not pressed within 3 minutes after reservations have been made , all current reservations will be lost.

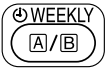

# WEEKLY TIMER OPERATION

## Step 2: Select Mode A or Mode B and activate or deactivate WEEKLY TIMER.

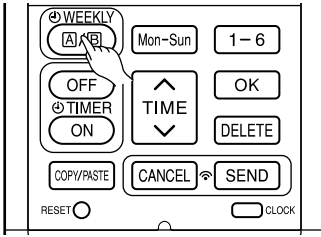

1

### ■ How to select Mode A or Mode B of WEEKLY TIMER setting.

1. Press (WEEKLY) button. **A** and blink on the display. (Normally Mode A will blink first).
2. Press (WEEKLY) button again. **B** and blink on the display.
3. Select Mode A or Mode B. Press (SEND) button while directing the remote controller towards the indoor unit for about 3 seconds. Timer lamp on the indoor unit will blink rapidly.

2

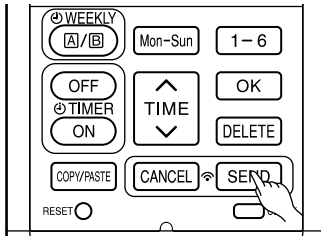

3

After beep sound emitted from indoor unit, TIMER lamp will light up.

### **Please ensure that the TIMER lamp lights up.**

This indicates that Mode A or Mode B selection and active WEEKLY TIMER have been confirmed.

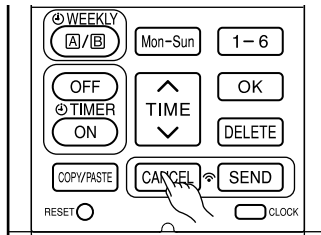

1

### ■ Setting non-active WEEKLY TIMER .

1. Direct the remote controller towards the indoor unit and press (CANCEL) button.  
Beep sound will be emitted from indoor unit and TIMER lamp will be OFF. Reservation indication on remote display will also disappear. This indicates that non-active WEEKLY TIMER has been confirmed.
- To activate back the setting of WEEKLY TIMER , repeat the steps for "How to select Mode A or Mode B of WEEKLY TIMER setting".

### NOTE

- When setting ONCE TIMER, operation of WEEKLY TIMER is interrupted. After ONCE TIMER operation is complete, WEEKLY TIMER operation will be activated.
- When ONCE TIMER is cancelled, operation of WEEKLY TIMER is also cancelled. Need to set WEEKLY TIMER operation for activation.
- After auto restart, WEEKLY TIMER operation is cancelled. Need to set WEEKLY TIMER operation for activation.

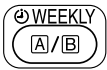

# WEEKLY TIMER OPERATION

## Step 3: Copy and cancel the reservation schedule.

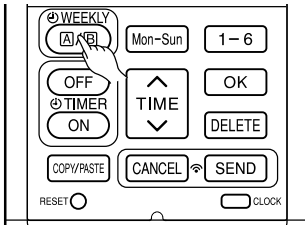

1

### ■ How to copy and paste.

Editing the reservation schedule is easy by copying data from one day to another day.

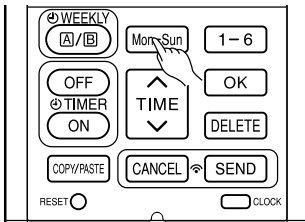

2

2. Press **WEEKLY (A/B)** (WEEKLY) button for about 3 seconds to start editing the reservation schedule.

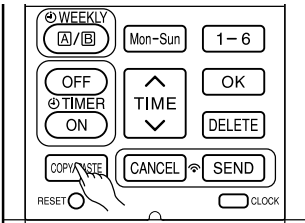

3

3. Press **Mon-Sun** (DAY) button to select a day of the week to copy.

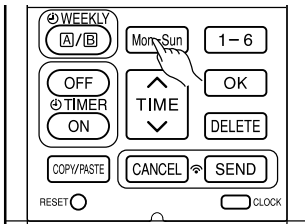

4

4. Press **COPY/PASTE** (COPY/PASTE) button. Then "PASTE" blinks on the display.  
\* Press **CANCEL** (CANCEL) button to cancel the COPY mode. Normal setting mode is activated.

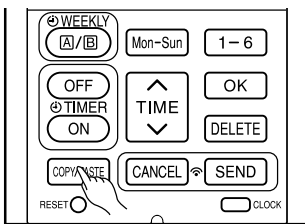

5

5. Press **Mon-Sun** (DAY) button to select a day of the week to paste.

6. Press **COPY/PASTE** (COPY/PASTE) button one more time to paste.  only blinks on the display.

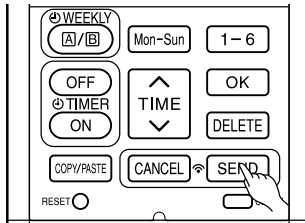

6

7. To continue copying to other days, press **Mon-Sun** or **1-6** or **TIME** or **OFF/TIMER ON**.

Then start from step 3.

8. After copy and paste completed, press **SEND** (SEND) button while directing the remote controller towards the indoor unit for about 3 seconds. Timer lamp on the indoor unit will blink rapidly. After beep sound emitted from indoor unit, TIMER lamp will light up.

8

### **Please ensure that the TIMER lamp lights up.**

If TIMER lamp does not light up, Press **SEND** (SEND) button again.

- Reservation data will not change if **SEND** (SEND) button is not pressed.

## NOTE

- If there is no reservation data, copying data from one day to another day cannot be done.





# WEEKLY TIMER OPERATION

## Step 3: Copy and cancel the reservation schedule.

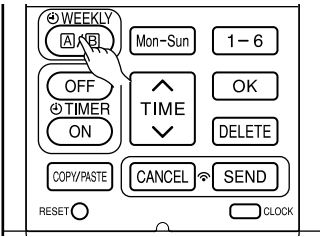

1

- How to delete WEEKLY TIMER data.

[Delete one program number reservation]

2

- Press (WEEKLY) button to select Mode A or Mode B.
- Press (WEEKLY) button for 3 seconds to start editing the reservation schedule.

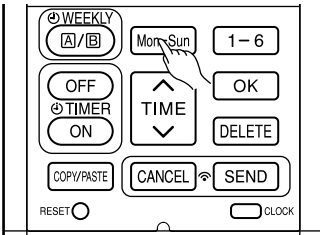

3

- Press (DAY) button to select a day of the week to edit.

- Press to select program number. Selected program number will blink.

- Press (DELETE) button. Reservation of selected program number is deleted.

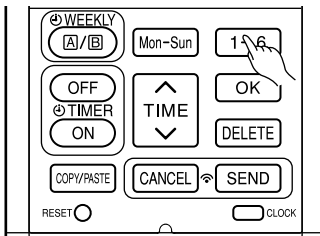

4

- After deleting, press (SEND) button while directing the remote controller towards the indoor unit for about 3 seconds. Timer lamp on the indoor unit will blink rapidly. After beep sound emitted from indoor unit, TIMER lamp will light up.

**Please ensure that the TIMER lamp lights up.**

- Reservation will not change if (SEND) button is not pressed.

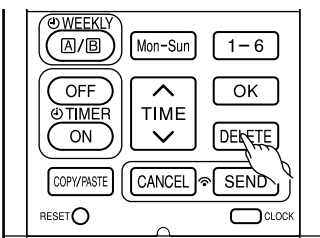

5

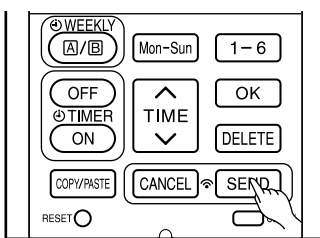

6



# WEEKLY TIMER OPERATION

## Step 3: Copy and cancel the reservation schedule.

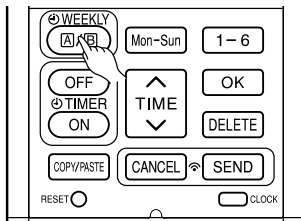

①

[Delete one day reservation]

1. Press (WEEKLY) button to select Mode A or Mode B.

②

2. Press (WEEKLY) button for 3 seconds to start editing the reservation schedule.

3. Press (DAY) button to select a day of the week to edit.

③

4. Press (DELETE) button for about 10 seconds. Reservations for all program numbers will be deleted.

- If press for a short time, reservation for one program number will be deleted.

5. After deleting, press (SEND) button while directing the remote controller towards the indoor unit for about 3 seconds. Timer lamp on the indoor unit will blink rapidly.

After beep sound emitted from indoor unit, TIMER lamp will light up.

**Please ensure that the TIMER lamp lights up.**

- Reservation will not change if (SEND) button is not pressed.

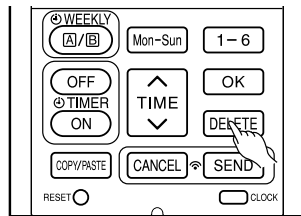
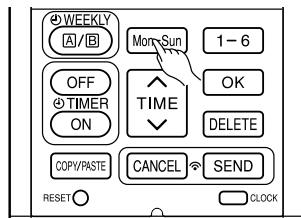

④

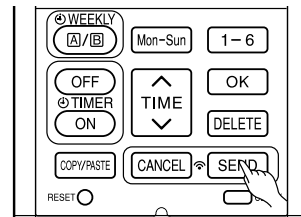

⑤

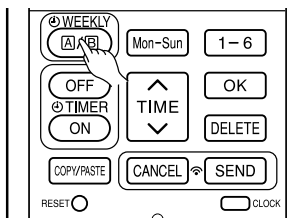

①

[Delete Mode A or Mode B]

1. Press (WEEKLY) button to select Mode A or Mode B.

2. Direct the remote controller towards the indoor unit and press (DELETE) button for about 10 seconds while Mode A or Mode B display blinks.

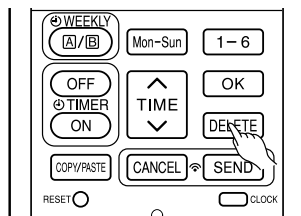

After beep sound emitted from indoor unit, reservations for Mode A or Mode B will disappear.

②



### NOTE

- If all reservations in the remote controller were deleted and pressed (SEND) button, no signal will be transmitted to indoor unit. TIMER lamp will remain off and no changes will be done to the reservations stored in the indoor unit.

- By pressing  (INFO) button, temperature around remote controller and monthly power consumption will be displayed on the remote controller.
- After changing the batteries, direct the remote controller towards the indoor unit and press  (INFO) button. Current calendar and clock will be transmitted from indoor unit.
- In order to receive information from indoor unit, the distance between remote controller and receiver of indoor units is within 2 meters.

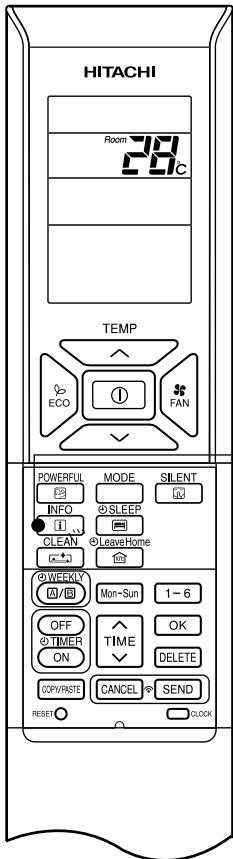

### ■ To check temperature around remote controller

1

Press  (INFO) button.

Temperature will be displayed for 10 seconds.

### ■ To check monthly power consumption

Direct the remote controller towards the receiver of indoor unit (within 2 meters in front of indoor unit) and press  (INFO) button. Wait for 2 seconds for signal transmission.

While temperature around remote controller is displayed, press  (INFO) button repeatedly. The display will show as below:

this month power consumption amount for heating → last month power consumption amount for heating → this month power consumption amount for cooling → last month power consumption amount for cooling → temperature around remote controller → this month power consumption amount for heating ..... cyclically.

- If indication is not given, bring remote controller closer to the receiver of the indoor unit.
- Indicated value shall be regarded as a guide only.



### ■ Current calendar and clock can be retrieved from indoor unit

Direct the remote controller towards the receiver of indoor unit (within 2 meters in front of indoor unit) and press  (INFO) button. Wait for 2 seconds for signal transmission.

Once received the current calendar and clock, check whether they are correct or not by pressing  (CLOCK) button.

- If there is no power supply to indoor unit or calendar and clock have not been set, INFO function cannot be used for sending or receiving information.

### NOTE

- In case failure occurs to the air conditioner, by pressing  (INFO) button, an error code will be displayed. Direct the remote controller towards the receiver of indoor unit (within 2 meters in front of indoor unit) and press  (INFO) button. Wait for 2 seconds for signal transmission. An error code will be displayed. Call service center and inform the error code.
- Information of "Monthly power consumption" are not available for 6 rooms multi system.
- Info Function to check monthly power consumption. During installation, in case of power failure or breaker ON / OFF, ensure to set the clock and calendar for each indoor unit (unit in standby mode or auto restart), for single or multi connection, by pressing  (START / STOP) button. Failure to do the above, monthly power consumption amount will not be displayed on the remote controller.

# OPERATION MODE LOCK

The remote controller can be set to fix the HEATING mode (including FAN), COOLING mode (including FAN) and DEHUMIDIFYING mode (including FAN) operations.

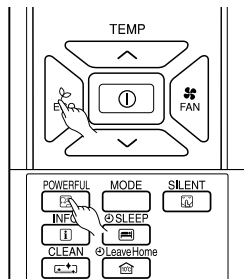

■ Method to lock HEATING mode (including FAN) operation.

Press (ECO) and (POWERFUL) buttons simultaneously for about 5 seconds when the remote controller is OFF.

“”, “” and “” will be displayed for about 10 seconds. Later, “” and “” will remain.

This indicates that HEATING mode operation is locked.

When pressing (MODE) button, “” or “” will be displayed.

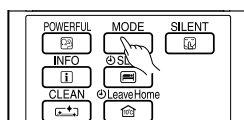

■ Method to unlock HEATING mode (including FAN) operation.

Press (ECO) and (POWERFUL) buttons simultaneously for about 5 seconds when the remote controller is OFF.

All operation mode symbols will appear on the display for about 10 seconds. After that, operation mode symbol before cancellation will be displayed.

This indicates that HEATING mode operation is unlocked.

■ Method to lock COOLING and DEHUMIDIFYING modes (including FAN) operations.

Press (ECO) and (SILENT) buttons simultaneously for about 5 seconds when the remote controller is OFF.

“”, “”, “” and “” will be displayed for about 10 seconds. Later, “” and “” will remain.

This indicates that COOLING and DEHUMIDIFYING mode operation is locked.

When pressing (MODE) button, “”, “” or “” will be displayed.

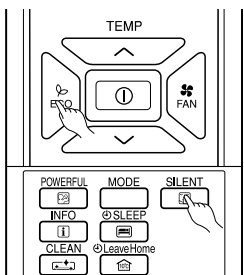

■ Method to unlock COOLING and DEHUMIDIFYING modes (including FAN) operations.

Press (ECO) and (SILENT) buttons simultaneously for about 5 seconds when the remote controller is OFF.

All operation mode symbols will appear on the display for about 10 seconds. After that, operation mode symbol before cancellation will be displayed.

This indicates that COOLING and DEHUMIDIFYING modes operation is unlocked.

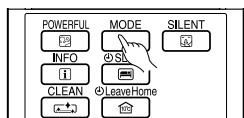

## NOTE

- Operation Mode Lock function will not activate if TIMER reservations activate. TIMER reservations shall be deactivated first. Then, Operation Mode Lock function can be activated.
- HEATING, COOLING and DEHUMIDIFYING mode (including FAN) operations can be unlocked by pressing the (RESET) button. However, by pressing the (RESET) button, all the information stored in the remote controller will disappear. You may need to set the necessary information again.
- For multi connections, unit and mode which is set to lock HEATING and switched on first shall have higher priority. Other units which are chosen to operate at different modes shall be in STANDBY until either the first unit operation is switched off or the mode is selected to be same as the first unit.

# CONSTRUCTION AND DIMENSIONAL DIAGRAM FOR INDOOR

MODEL RAD-18QPB, RAD-25QPB, RAD-35QPB, RAD-50QPB

Unit: mm

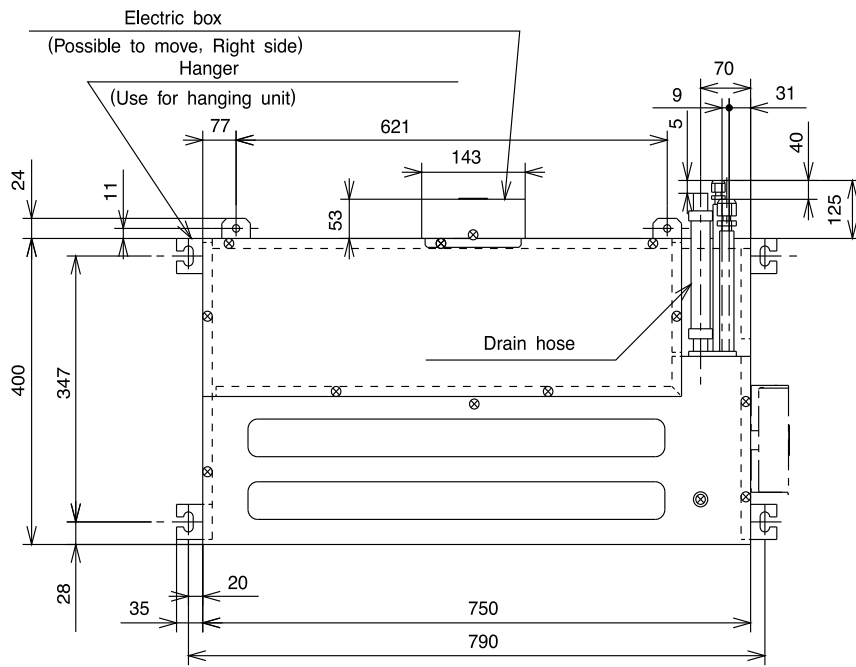

OPTIONAL  
Wired Remote Controller  
(SPX-RCDA)

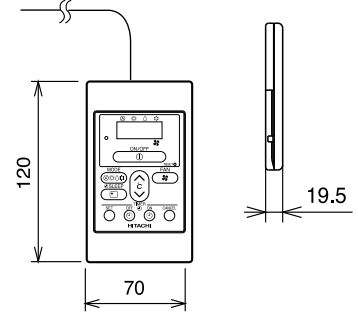

OPTIONAL  
Wireless Remote Controller  
(SPX-RCKA 1)

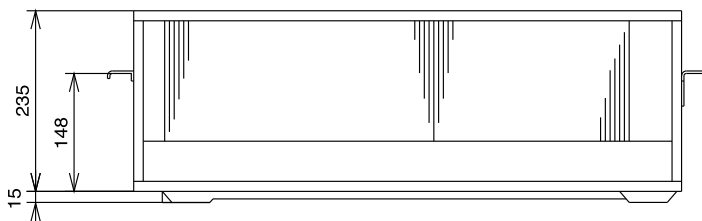
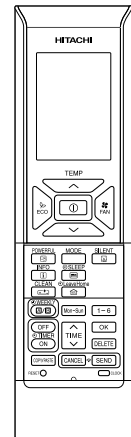

Narrow pipe (ø6.35)

Wide pipe (ø9.52)

\* Wide pipe (ø12.7)

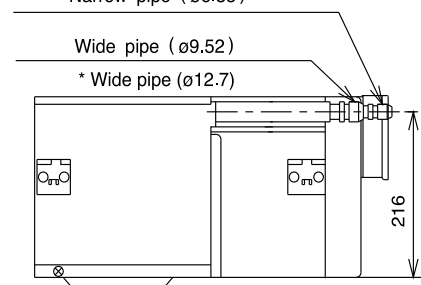

### BACK SUCTION

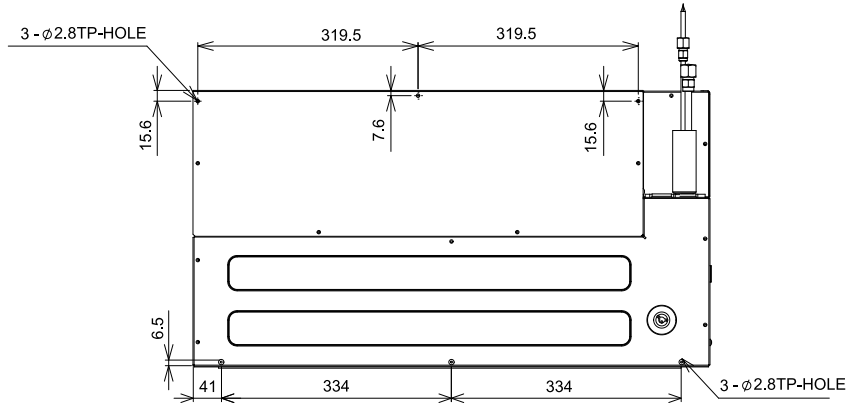
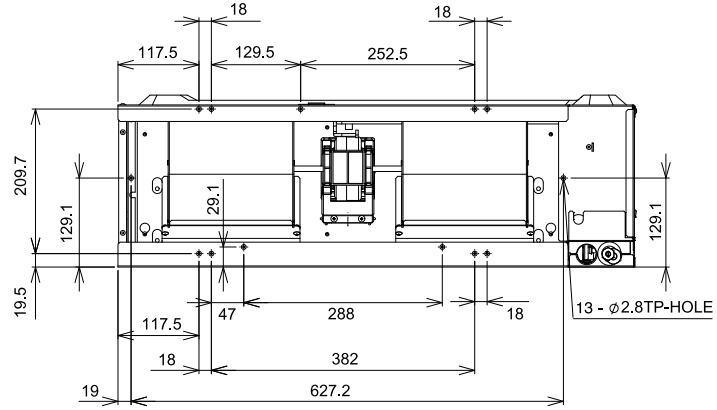

### DISCHARGE

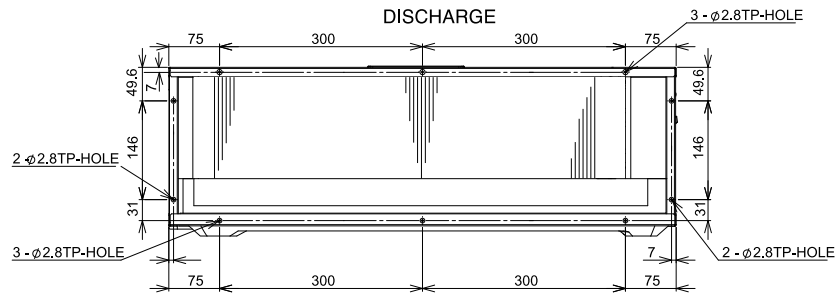

### BOTTOM SUCTION

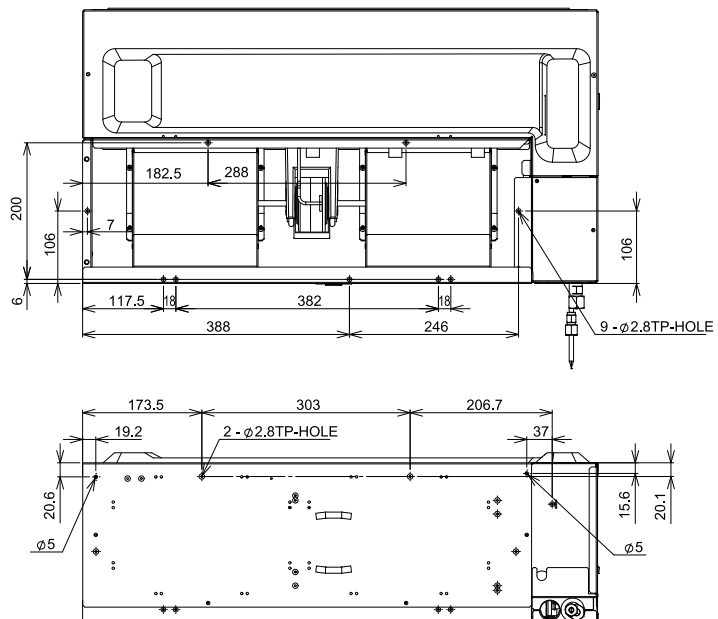

Cautions:

1. Use insulated pipes for both large and small diameters.

# MAIN PARTS COMPONENT

## THERMOSTAT

### Thermostat Specifications

MODEL			RAD-18QPB, RAD-25QPB, RAD-35QPB, RAD-50QPB	
THERMOSTAT MODEL			IC	
OPERATION MODE			COOL	HEAT
TEMPERATURE °C (°F)	INDICATION 16	ON	14.7 (16.58)	11.6 (21.70)
		OFF	14.9 (16.30)	11.4 (22.08)
	INDICATION 24	ON	10.0 (25.00)	7.9 (30.40)
		OFF	10.2 (24.55)	7.7 (30.99)
	INDICATION 32	ON	6.7 (34.28)	5.5 (39.07)
		OFF	6.9 (33.58)	5.3 (39.99)

## FAN MOTOR

### Fan Motor Specifications

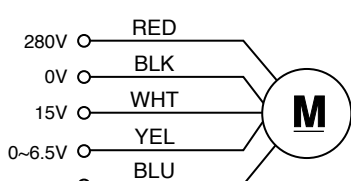
MODEL	RAD -18QPB, RAD-25QPB, RAD-35QPB, RAD-50QPB
POWER SOURCE	DC 100 ~ 380V
OUTPUT	30W
CONNECTION	 <p>RAD -18QPB, RAD-25QPB, RAD-35QPB, RAD-50QPB</p>

BLU : BLUE

YEL : YELLOW

BRN : BROWN

WHT : WHITE

GRY : GRAY

ORN : ORANGE

GRN : GREEN

RED : RED

BLK : BLACK

PNK : PINK

VIO : VIOLET

# WIRING DIAGRAM

MODEL RAD-18QPB, RAD-25QPB, RAD-35QPB, RAD-50QPB

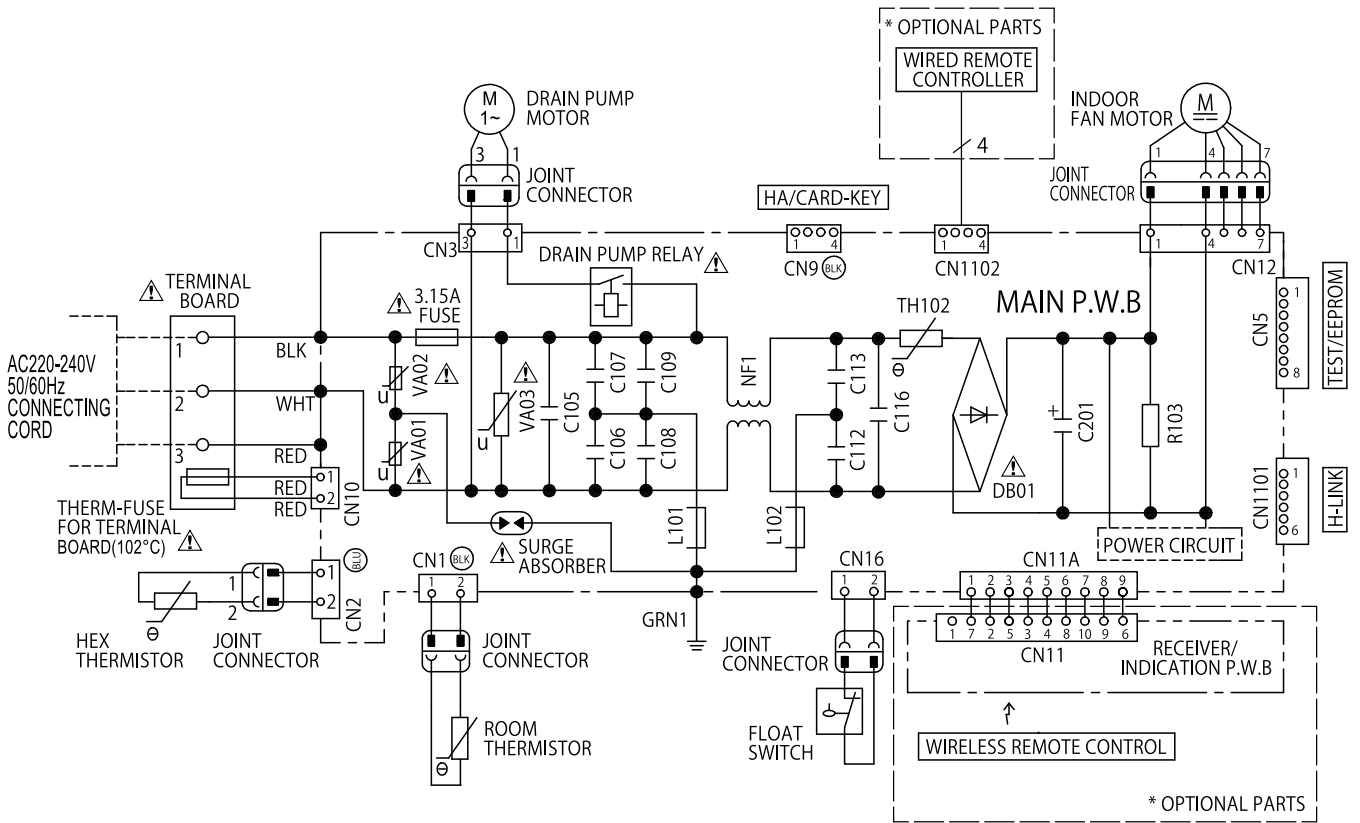

- |              |              |             |
|--------------|--------------|-------------|
| BLU : BLUE   | WHT : WHITE  | GRN : GREEN |
| YEL : YELLOW | GRY : GRAY   | RED : RED   |
| BRN : BROWN  | ORN : ORANGE | BLK : BLACK |

## CAUTION

The marked parts are very important ones for safety.



# CIRCUIT DIAGRAM

## Wired Remote Controller

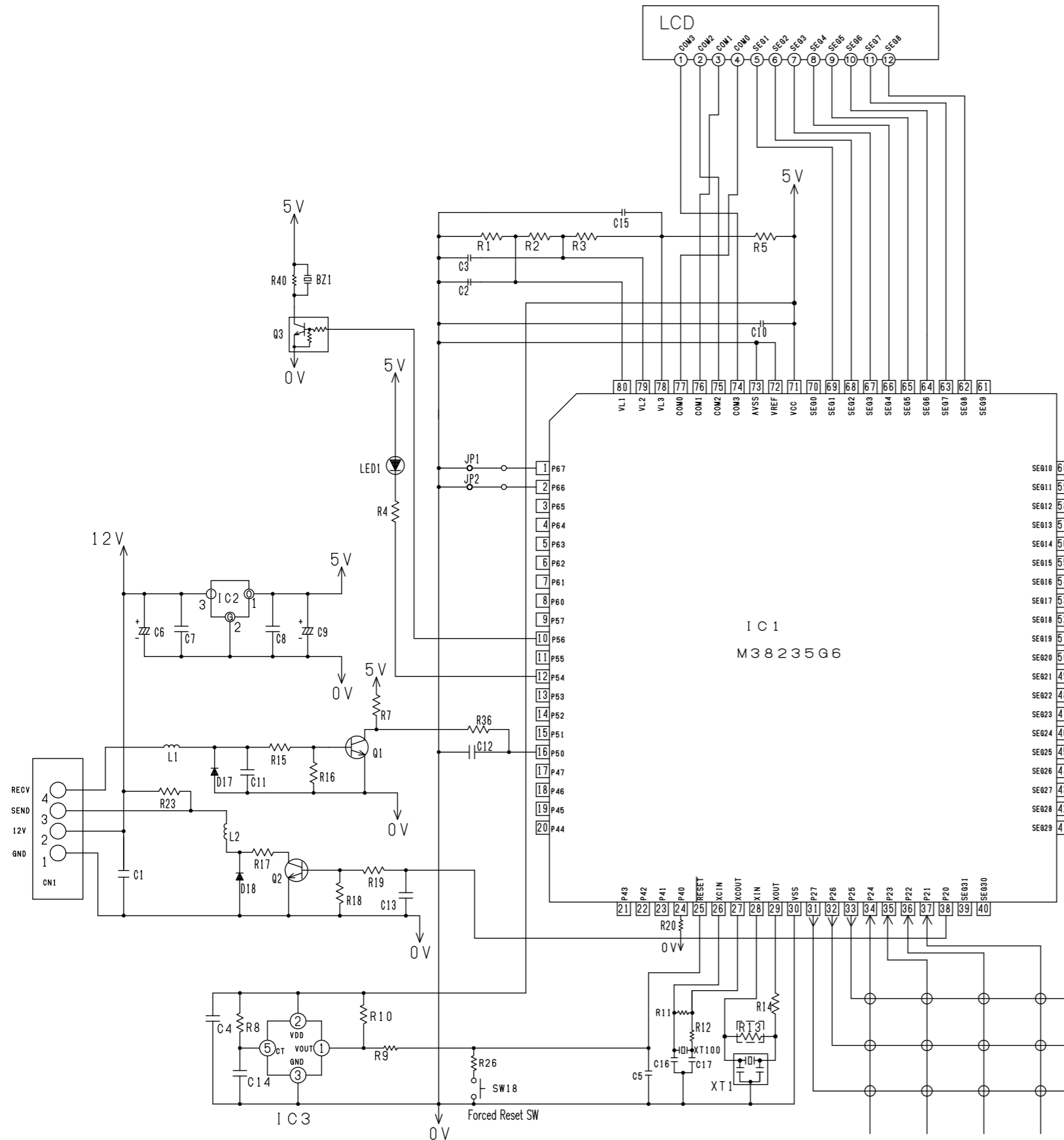

### Resistor

symbol	resistance (Ω)	tolerance	power rating (W)	mounting form	surface	remark
R1	220k	5%	1/10	C	A	1608
R2	220k	5%	1/10	C	A	1608
R3	220k	5%	1/10	C	A	1608
R4	1k	5%	1/10	C	A	1608
R5	430k	5%	1/10	C	A	1608
R7	10k	5%	1/10	C	A	1608
R8	No Mount		1/10	C	A	1608
R9	1k	5%	1/10	C	A	1608
R10	300k	5%	1/10	C	A	1608
R11	10M	5%	1/10	C	A	1608
R12	220k	5%	1/10	C	A	1608
R13	No Mount		1/10	C	A	1608
R14	0	5%	1/10	C	A	1608
R15	10k	5%	1/10	C	A	1608
R16	10k	5%	1/10	C	A	1608
R17	0	5%	1/10	C	A	1608
R18	10k	5%	1/10	C	A	1608
R19	10k	5%	1/10	C	A	1608
R20	4.7k	5%	1/10	C	A	1608
R23	10k	5%	1/10	C	A	1608
R26	1k	5%	1/10	C	A	1608
R36	1k	5%	1/10	C	A	1608
R40	No Mount		1/10	C	A	1608
JP1	No Mount		1/10	C	A	1608
JP2	No Mount		1/10	C	A	1608

### Capacitor

symbol	capacitance (μF)	rated voltage (V)	type	mounting form	surface	remark	temperature compensating
C1	0.1	25	C	C	A	1608	B
C2	0.1	25	C	C	A	1608	B
C3	0.1	25	C	C	A	1608	B
C4	0.1	25	C	C	A	1608	B
C5	0.1	25	C	C	A	1608	B
C6	10	25	D	C	A		
C7	0.1	25	C	C	A	1608	B
C8	0.1	25	C	C	A	1608	B
C9	10	25	D	C	A		
C10	1	16	C	C	A	1608	B
C11	470p	50	C	C	A	1608	B
C12	470p	50	C	C	A	1608	B
C13	470p	50	C	C	A	1608	B
C14	0.01	50	C	C	A	1608	B
C15	0.1	25	C	C	A	1608	B
C16	18p	50	C	C	A	1608	CH
C17	22p	50	C	C	A	1608	CH

表1 キーマトリックス表  
Table1. Key-matrix table

Output \ Input	P21	P22	P23	P24
P25	(自動風向) (Auto lower)	取消 Cancel	風速切換 Wind speed select	予約 Book
P26	切タイマー Off	入タイマー On	温度 Temperature up	温度 Temperature down
P27	運転/停止 Start/Stop	—	おやすみ Sleep	運転切換 Drive mode select

### Diode

symbol	product name	mounting form	surface
D17	1SS355	C	A
D18	1SS355	C	A

### LED

symbol	product name	mounting form	surface
LED1	SML-811WT (A)	C	A

### IC

symbol	product name	mounting form	surface
IC1	M38235G6-105HP	C	A
IC2	NJM78L05UA	C	A
IC3	S-80942CNMC-69CT2G	C	A

### Coil

symbol	product name	mounting form	surface
L1	BLM18AG102SN1D	C	A
L2	BLM18AG102SN1D	C	A

### Transistor

symbol	product name	mounting form	surface
Q1	2SC2412K	C	A
Q2	2SC2412K	C	A
Q3	No Mount	C	A

### Resonators

symbol	product name	mounting form	surface
XT100	CFS2063276	H	A
XT1	CSTCR4M00G55-R0	C	A

### Connector

symbol	product name	mounting form	surface
CN1	S4B-ZR-SM4A-TF	C	A

### Buzzer

symbol	product name	mounting form	surface
BZ1	NO MOUNT	C	B

# CIRCUIT DIAGRAM

Wireless Remote Controller

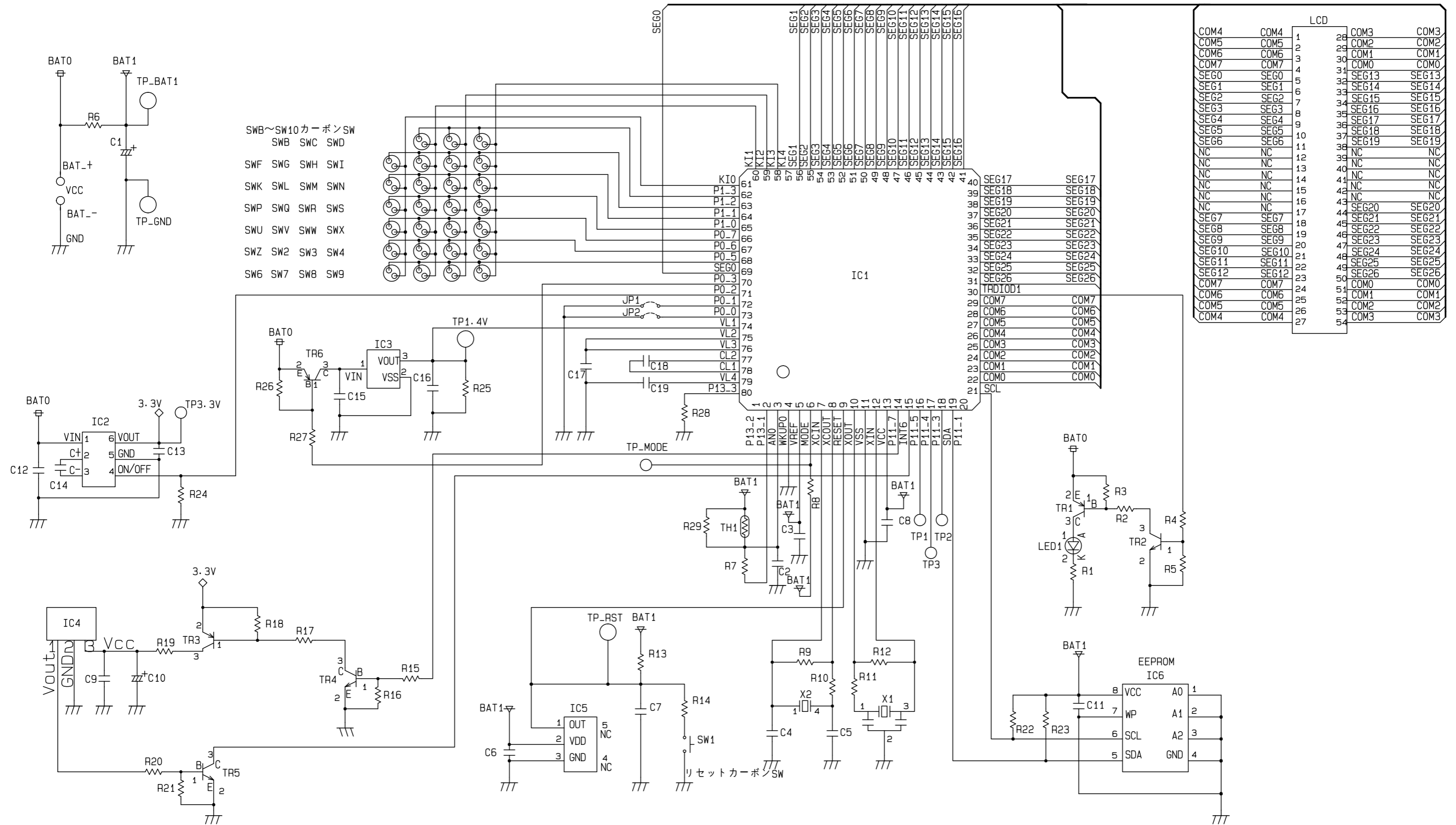

LCD			
COM4	COM4	1	28
COM5	COM5	2	29
COM6	COM6	3	30
COM7	COM7	4	31
SEG0	SEG0	5	32
SEG1	SEG1	6	33
SEG2	SEG2	7	34
SEG3	SEG3	8	35
SEG4	SEG4	9	36
SEG5	SEG5	10	37
SEG6	SEG6	11	38
NC	NC	12	39
NC	NC	13	40
NC	NC	14	41
NC	NC	15	42
NC	NC	16	43
NC	NC	17	44
SEG7	SEG7	18	45
SEG8	SEG8	19	46
SEG9	SEG9	20	47
SEG10	SEG10	21	48
SEG11	SEG11	22	49
SEG12	SEG12	23	50
COM7	COM7	24	51
COM6	COM6	25	52
COM5	COM5	26	53
COM4	COM4	27	54
			55



# BLOCK DIAGRAM

MODEL RAD-18QPB, RAD-25QPB, RAD-35QPB, RAD-50QPB

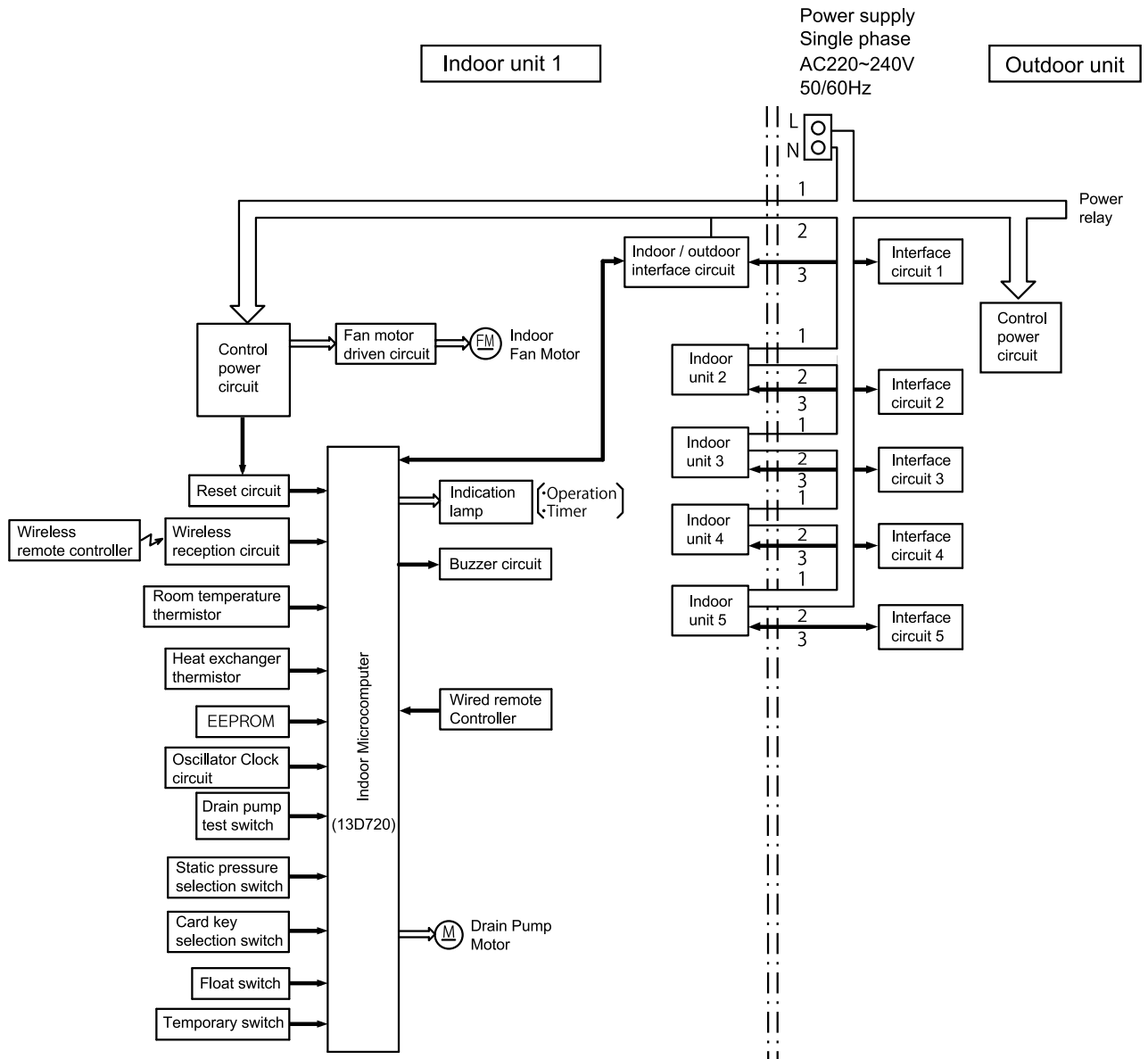

# PRINTED WIRING BOARD LOCATION DIAGRAM

MODEL RAD-18QPB, RAD-25QPB, RAD-35QPB, RAD-50QPB

## Main board [component side]

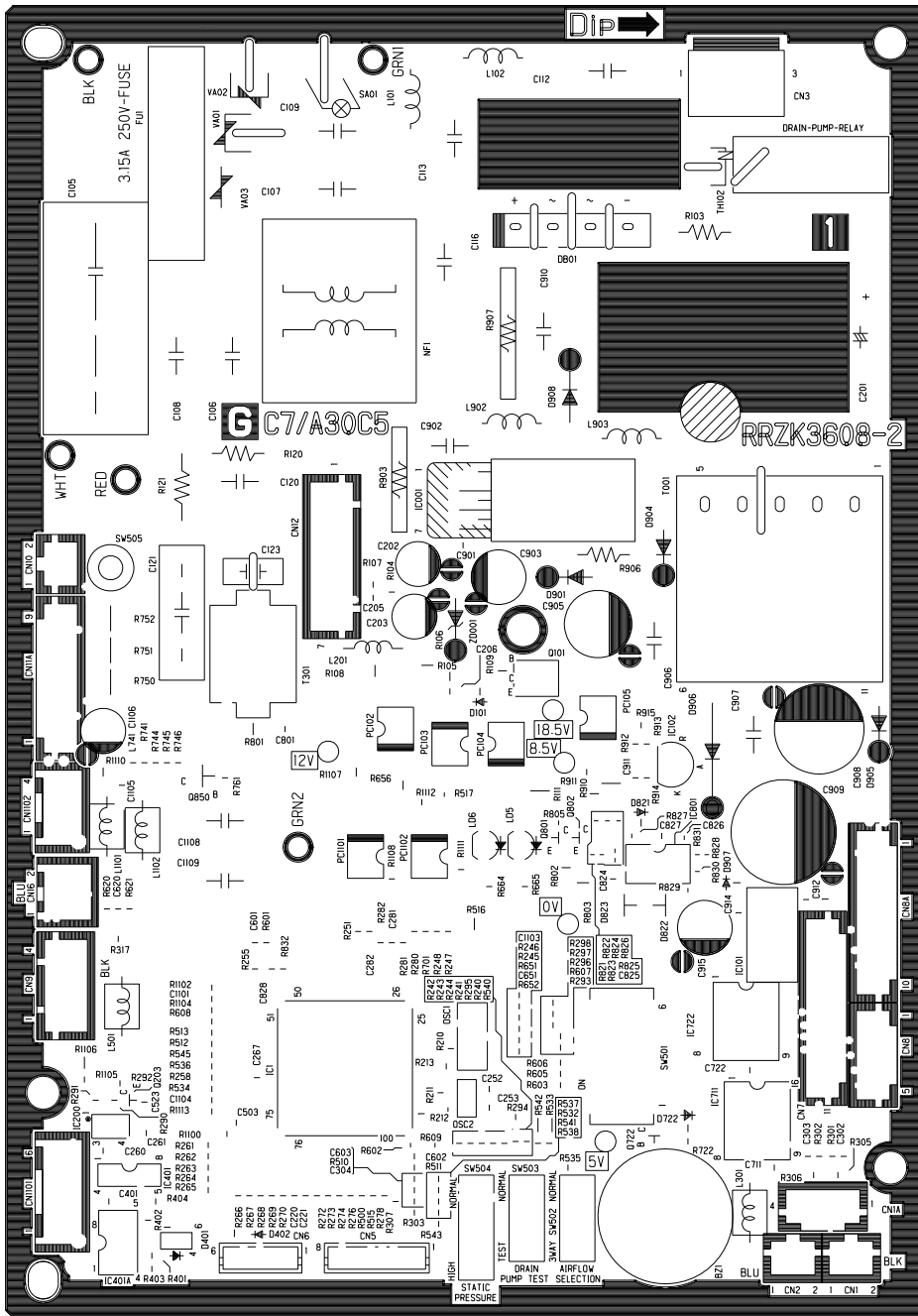

# Main board [solder side]

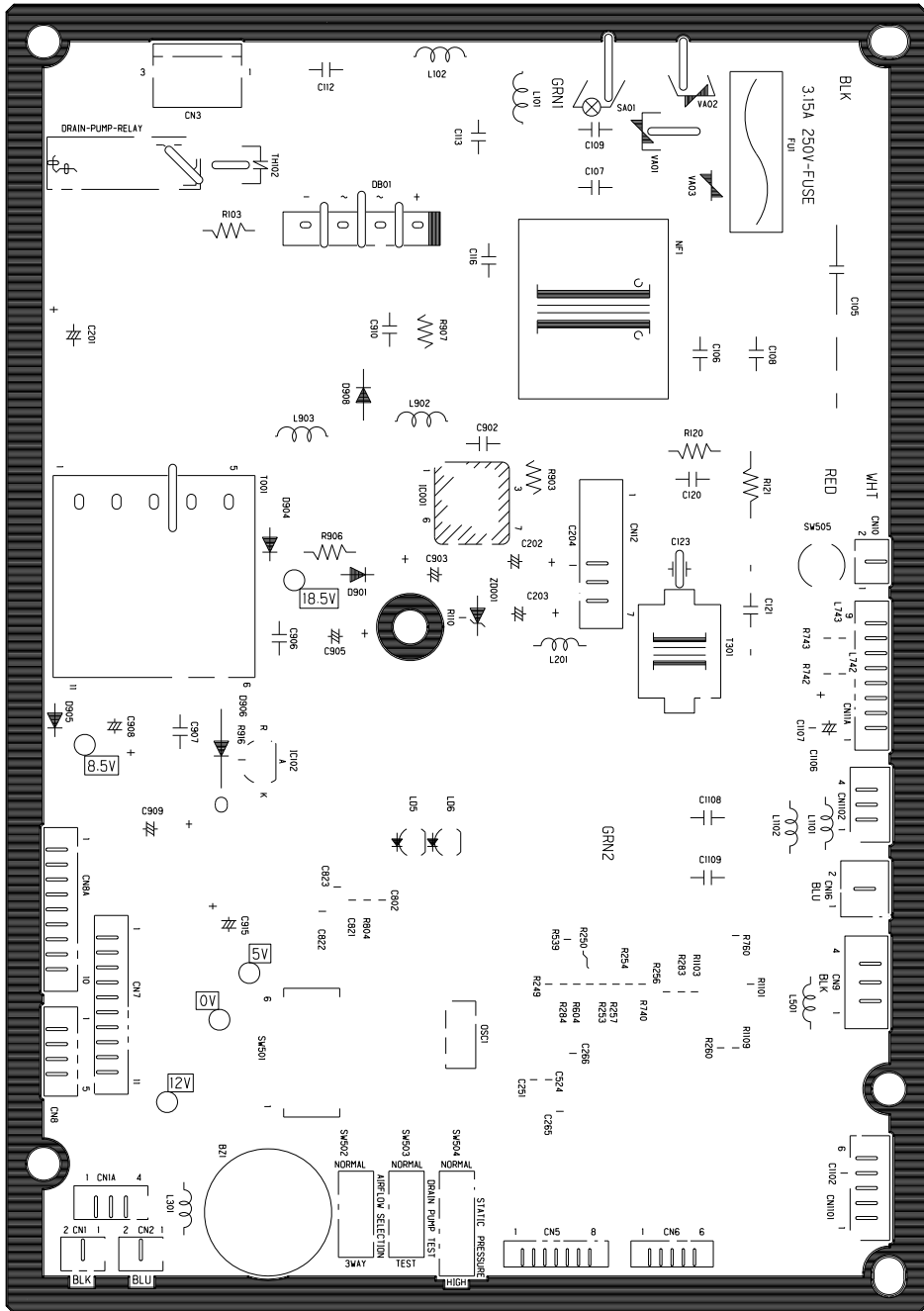

# BASIC MODE

MODEL RAD-18QPB, RAD-25QPB, RAD-35QPB, RAD-50QPB,

Operation mode		Fan	Cooling	Dehumidifying	Heating	Auto
Basic operation of start/stop button						
Timer functions	Off-timer					
	On-timer					
	Off -> On On -> Off timer					
Fan speed mode (indoor fan)	Auto	<p>Changes from "Hi" to "Med" or "Lo" depending on room temperature.</p> <ol style="list-style-type: none"> <li>Runs at "Hi" until room temperature reaches to "setting temperature-SFTDSC_M" after operation is started.</li> <li>Runs at "ultra-Lo" when thermo is off.</li> </ol>	<p>Set to "ultra-Hi" when the compressor runs at cold dash mode speed, and to "Hi" in other modes. Runs at "ultra-Lo" when thermo is off.</p>	<p>Set to "ultra-Lo" depending on the room temperature, time and heat exchanger temperature. Set to "stop" if the heat exchanger temperature is "DNZKOF_M" during Thermo OFF.(When reach at "DNZKON_M", fan speed set to "ultra-Lo" again.)</p> <p>In modes other than left</p>	<p>Operating mode is judged by room temperature.</p> <p>(1) Judging by room temperature</p> <ul style="list-style-type: none"> <li>Operating mode at start up is judged (initial judgment).</li> <li>(a) Conditions for judgment (any of the followings). <ul style="list-style-type: none"> <li>When auto operation is started after the previous auto mode operation.</li> <li>When auto operation is started after the previous manual mode operation.</li> <li>When the operating mode is switched to auto while operating at manual mode.</li> </ul> </li> <li>(b) Judging method <ul style="list-style-type: none"> <li>[ Cooling ] : Room temperature <math>\geq</math> Remote controller setting</li> <li>[ Heating ] : Room temperature <math>&lt;</math> Remote controller setting</li> </ul> </li> </ul>	
	Hi	Operates at "Hi" regardless of the room temperature.	Set to "ultra-Hi" when the compressor runs at cold dash mode speed, and to "Hi" in other modes. Runs at "ultra-Lo" when thermo is off.	Set to "ultra-Lo", "Silent", "Lo", "Med", "Hi", "ultra-Hi" or "stop" depending on the room temperature, time and heat exchanger temperature. Set to "stop" if the heat exchanger temperature is "DNZKOF_M" during Thermo OFF.(When reach at "DNZKON_M", fan speed set to "ultra-Lo" again.)	Set to "ultra-Hi" when the compressor is running at maximum speed during hot dash or when recovered from defrosting.	
	Med	Operates at "Med" regardless of the room temperature.	Operates at "Med" regardless of the room temperature. Runs at "ultra-Lo" when thermo is off.	Set to "ultra-Lo", "Silent", "Lo", "Med", "Hi", "ultra-Hi" or "stop" depending on the room temperature, time and heat exchanger temperature. Set to "stop" if the heat exchanger temperature is "DNZKOF_M" during Thermo OFF.(When reach at "DNZKON_M", fan speed set to "ultra-Lo" again.)	Set to "ultra-Lo", "Silent", "Lo", "Med", "Hi", "ultra-Hi" or "stop" depending on the room temperature, time and heat exchanger temperature. Set to "stop" if the heat exchanger temperature is "DNZKOF_M" during Thermo OFF.(When reach at "DNZKON_M", fan speed set to "ultra-Lo" again.) The fan speed is controlled by the heat exchanger temperature; the overload control is executed as in the following diagram:	
	Lo	Operates at "Lo" regardless of the room temperature.	Operates at "Lo" regardless of the room temperature. Runs at "ultra-Lo" when thermo is off.	Set to "Lo" in modes other than when the compressor stops.	Set to "ultra-Lo", "Silent", "Lo", "Med", "Hi", "ultra-Hi" or "stop" depending on the room temperature, time and heat exchanger temperature. Set to "stop" if the heat exchanger temperature is "DNZKOF_M" during Thermo OFF.(When reach at "DNZKON_M", fan speed set to "ultra-Lo" again.) The fan speed is controlled by the heat exchanger temperature; the overload control is executed as in the following diagram:	
	Silent	Operates at "Silent" regardless of the room temperature.	Operates at "Silent" regardless of the room temperature. Runs at "ultra-Lo" when thermo is off.	Set to "Silent" in modes other than when the compressor stops.	Set to "ultra-Lo", "Silent", "Lo", "Med", "Hi", "ultra-Hi" or "stop" depending on the room temperature, time and heat exchanger temperature. Set to "stop" if the heat exchanger temperature is "DNZKOF_M" during Thermo OFF.(When reach at "DNZKON_M", fan speed set to "ultra-Lo" again.) The fan speed is controlled by the heat exchanger temperature; the overload control is executed as in the following diagram:	
Basic operation of temperature controller	Performs only fan operation at the set speed regardless of the room temperature.	See page 41.	See page 43.	See page 45.		
Sleep operation (with sleep button ON)	Enters sleep operation after set as on the left.	Same as at left See page 47	Same as at left See page 44	Same as at left See page 46	Same as at left. Performs the sleep operation of each operation mode	

Table 1 mode data file

<b>LABEL NAME</b>	<b>RAD-18QPB</b>	<b>RAD-25QPB</b>	<b>RAD-35QPB</b>	<b>RAD-50QPB</b>
WMAX_M	4900 min <sup>-1</sup>	4900 min <sup>-1</sup>	4900 min <sup>-1</sup>	4900 min <sup>-1</sup>
WMAX2_M	4900 min <sup>-1</sup>	4900 min <sup>-1</sup>	4900 min <sup>-1</sup>	4900 min <sup>-1</sup>
WMAX3_N	4900 min <sup>-1</sup>	4900 min <sup>-1</sup>	4900 min <sup>-1</sup>	4900 min <sup>-1</sup>
WSTD_M	3500 min <sup>-1</sup>	3500 min <sup>-1</sup>	3500 min <sup>-1</sup>	3500 min <sup>-1</sup>
CMAX_M	4200 min <sup>-1</sup>	4200 min <sup>-1</sup>	4200 min <sup>-1</sup>	4200 min <sup>-1</sup>
CMAX2_M	4200 min <sup>-1</sup>	4200 min <sup>-1</sup>	4200 min <sup>-1</sup>	4200 min <sup>-1</sup>
CMAX3_M	4200 min <sup>-1</sup>	4200 min <sup>-1</sup>	4200 min <sup>-1</sup>	4200 min <sup>-1</sup>
CSTD_M	3500 min <sup>-1</sup>	3500 min <sup>-1</sup>	3500 min <sup>-1</sup>	3500 min <sup>-1</sup>
WMINSZ_M	1700 min <sup>-1</sup>	1700 min <sup>-1</sup>	1700 min <sup>-1</sup>	1700 min <sup>-1</sup>
CMIN_M	1200 min <sup>-1</sup>	1200 min <sup>-1</sup>	1200 min <sup>-1</sup>	1200 min <sup>-1</sup>
STARTMC	60 sec	60 sec	60 sec	60 sec
DWNRATEW_M	80%	80%	80%	80%
DWNRATEC_M	80%	80%	80%	80%
SHIFTW_M	0°C	0°C	0°C	0°C
SHIFTC_M	0°C	0°C	0°C	0°C
CLMXTP_M	33°C	33°C	33°C	33°C
YNEOF_M	24°C	24°C	24°C	24°C
TEION_M	2°C	2°C	2°C	2°C
TEIONF_M	9°C	9°C	9°C	9°C
SFTDSW_M	0.66°C	0.66°C	0.66°C	0.66°C
DFTIM_OTP0	50 minutes	50 minutes	50 minutes	50 minutes
DFTIM_OTP5	60 minutes	60 minutes	60 minutes	60 minutes
DFTIM_OTP10	90 minutes	90 minutes	90 minutes	90 minutes



## Basic Cooling Operation

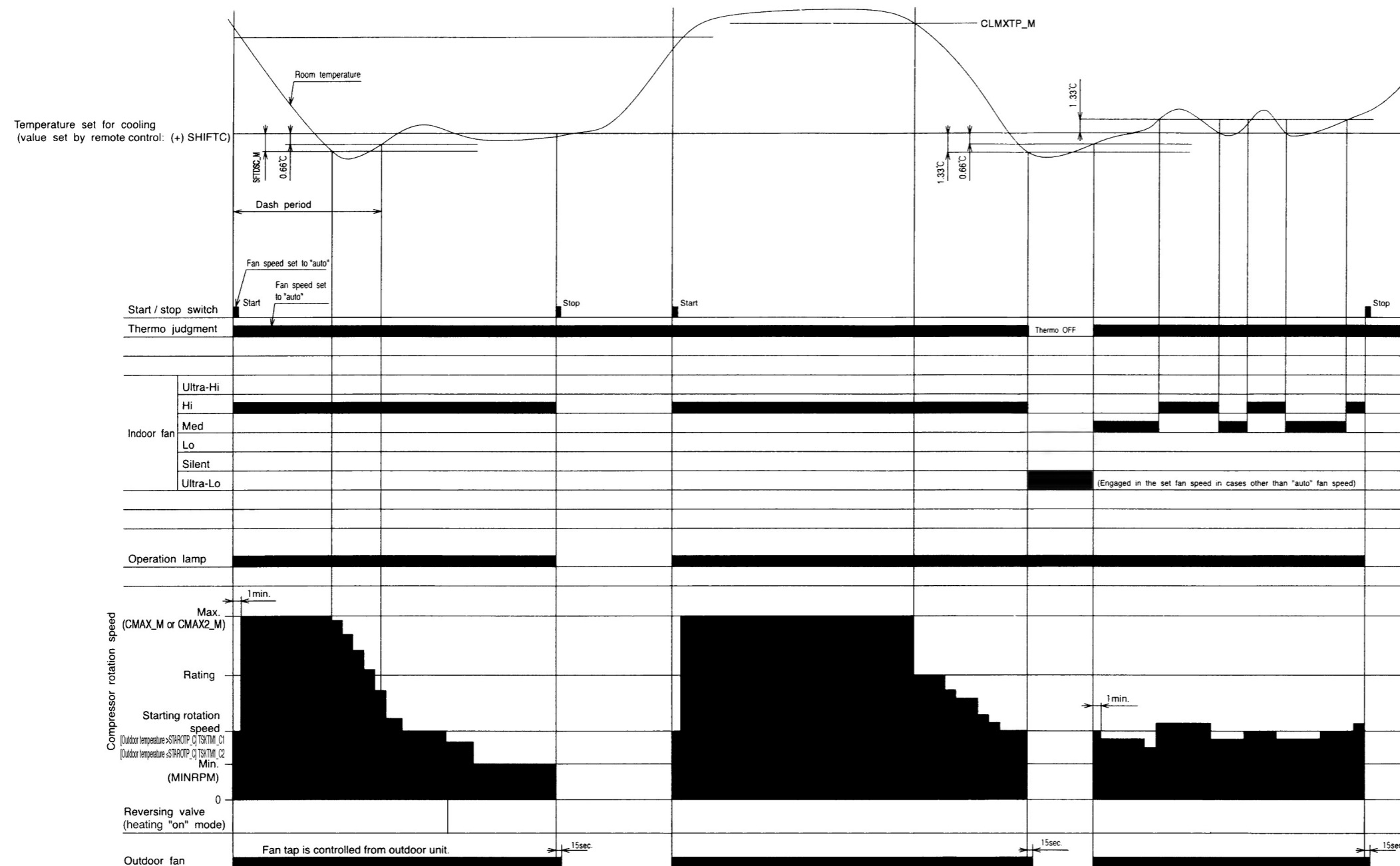

### Notes:

- (1) Cool dash is started when the operation is started at fan speed "AUTO" or "HI" or when the fan speed is changed to "AUTO" or "HI" during cooling operation, and when the compressor speed (P item) reaches ( $\text{CMAX\_M}$  or  $\text{CMAX2\_M}$ ) or higher.
- (2) The maximum compressor speed period during cool dash is finished.
  - 1 When 25 minutes have elapsed after cool dash was started.
  - 2 When the room temperature reaches the cooling set temperature  $-1^{\circ}\text{C}$  (including cooling shift) and then becomes lower than the preset temperature by  $0.66^{\circ}\text{C}$  after the steady speed period
  - 3 When thermo is OFF.

(If cool dash finished in the above 1, the compressor does not go through the steady speed period but it starts fuzzy control.)
- (3) The thermo OFF temperature during cool dash is cooling set temperature (including cooling shift)  $-3^{\circ}\text{C}$ . After thermo OFF, cool dash is finished and fuzzy control starts.
- (4) The compressor minimum ON time and minimum OFF time is 3 minutes.
- (5) The time limit for which the maximum compressor speed ( $\text{CMAX\_M}$  or  $\text{CMAX2\_M}$ ) during normal cooling can be maintained is less than 60 minutes when the room temperature is less than  $\text{CLMXTP\_M}$ : it is not provided when the room temperature is  $\text{CLMXTP\_M}$  or more.
- (6) Compressor speed is determined by instruction sent from indoor unit and corrected by outdoor unit according to such factors as capacity, fan speed, number of units being operated, outdoor temperature, discharge pressure and etc.
- (7) If another indoor unit is doing heating operation, cooling operation cannot be done.

## Cooling Sleep Operation

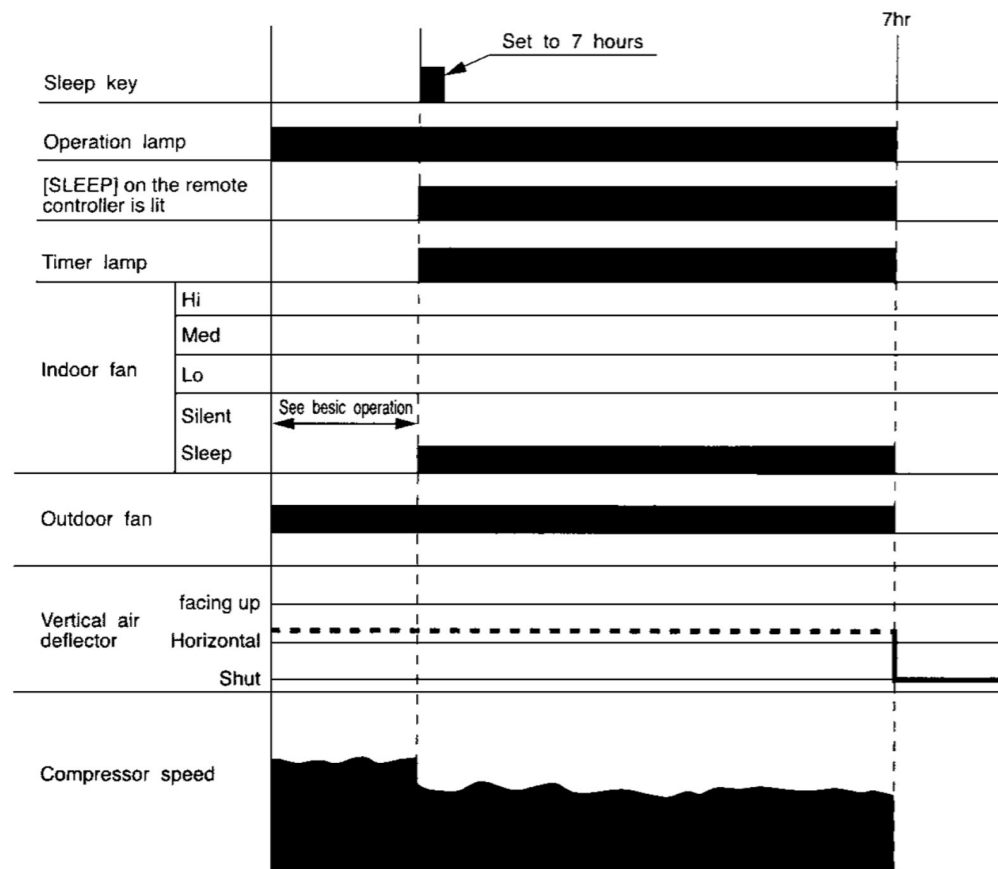

### Notes.

- (1) The sleep operation starts when the sleep key is pressed.
- (2) When the sleep key is set, the indoor fan is set to "sleep silent" (FCSOY\_M).
- (3) The indoor fan speed does not change even when the fan speed mode is changed.
- (4) If the set time is changed during sleep operation, all data including set temperature, time, etc. is cleared and restarted.
- (5) If sleep operation is canceled by the cancel key or sleep key, all data is cleared.
- (6) If the position of air deflector is being operated using remote control, the operation will be performed at any desired position of air deflector.

## Cooling Defrost

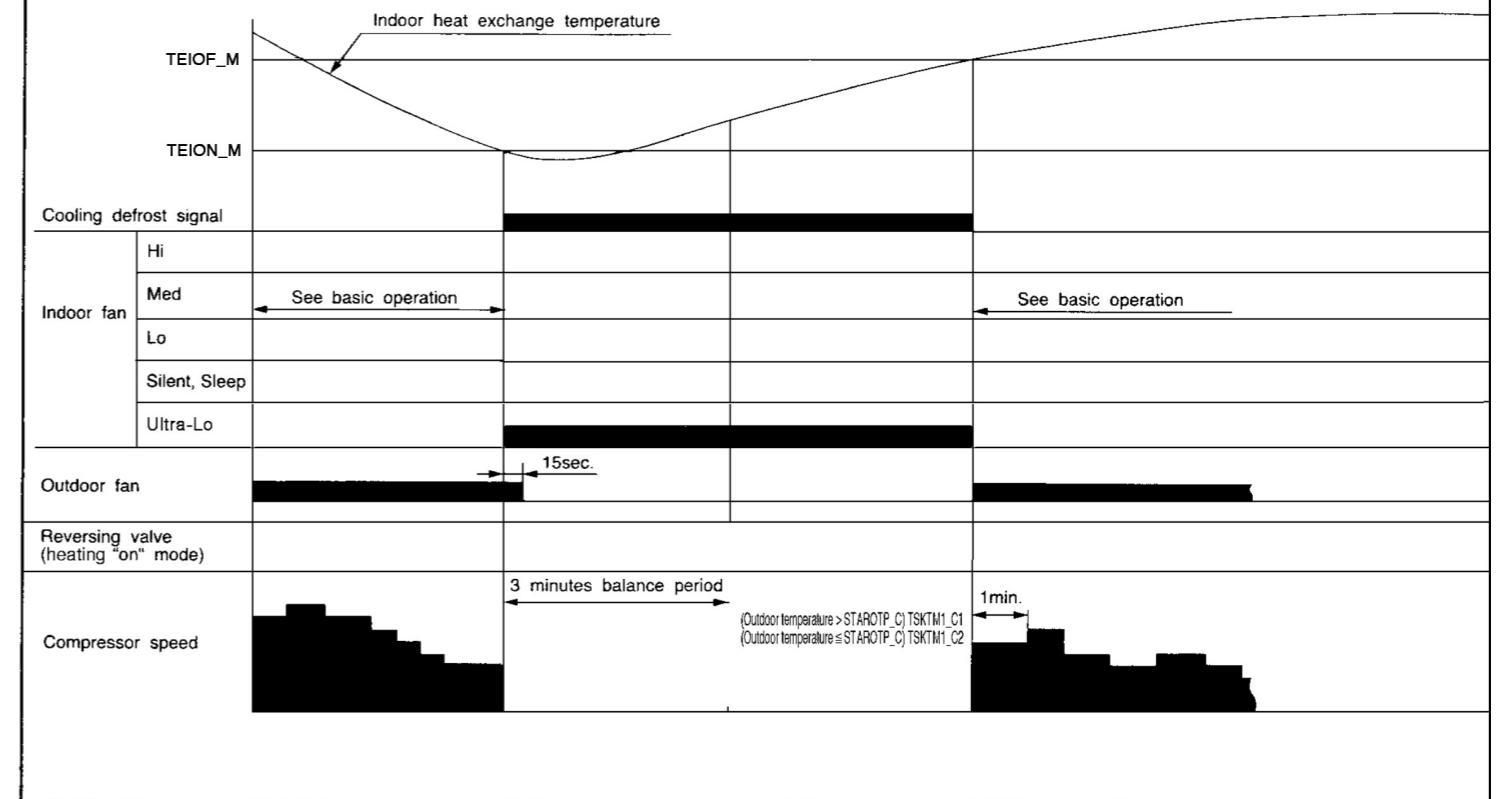

## Dehumidifying

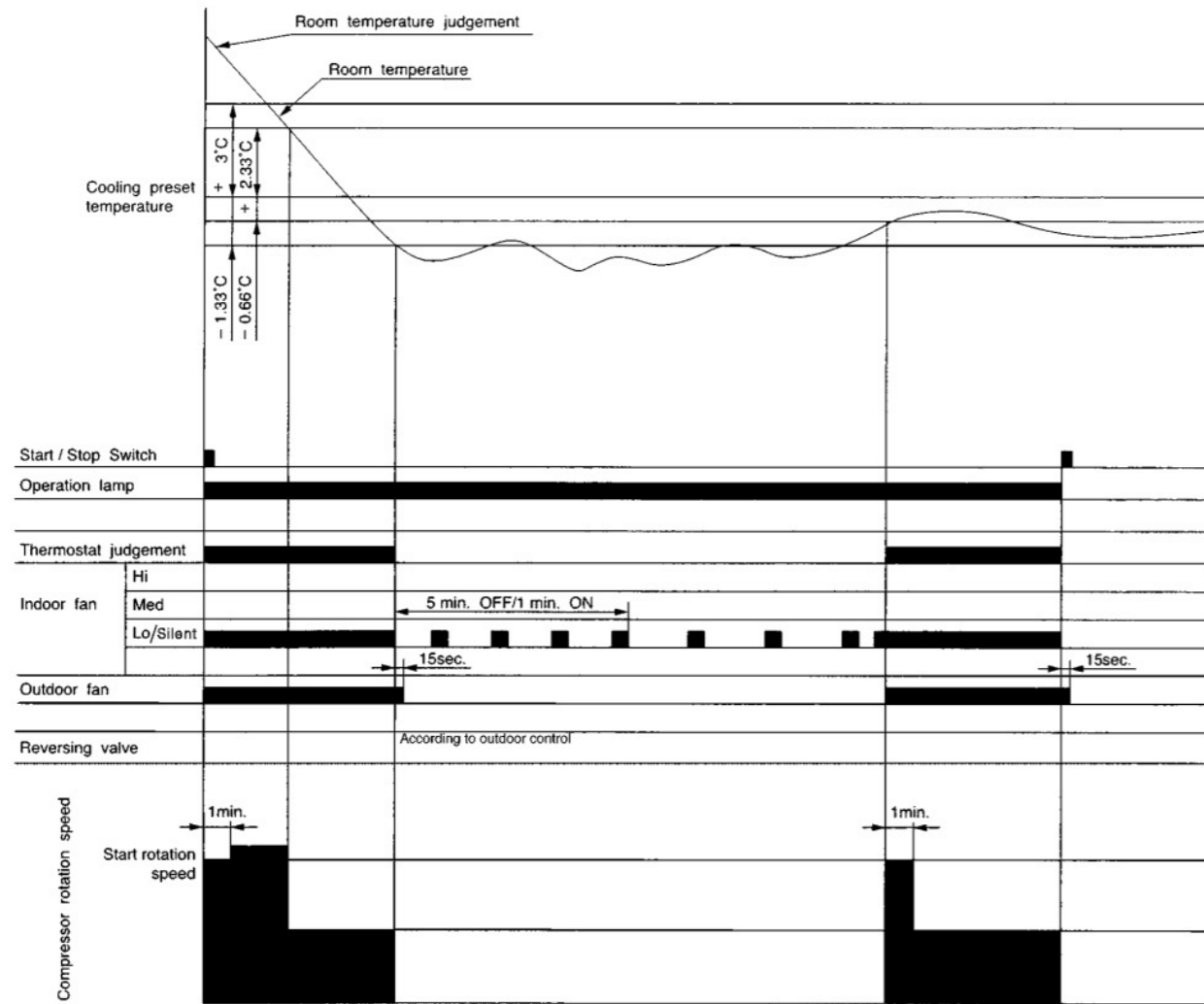

### Notes:

- (1) The indoor fan is operated in the "Lo" or "Silent" mode, OFF for 5 minutes and ON for 1 minute, repeatedly according to the humidity judgement when the thermostat is turned OFF.
- (2) The compressor is operated forcedly for 3 minutes after operation is started.
- (3) The minimum ON time and OFF time of the compressor are 3 minutes.
- (4) At the start of operation, the thermostat will be off when room temperature  $\leq$  setting temperature  $-1.33^{\circ}\text{C}$ ; the thermostat will be on when room temperature  $\geq$  setting temperature  $-0.66^{\circ}\text{C}$ .
- (5) The following procedure is performed to prevent excessive cooling during operation other than start. However, this procedure applies only when the thermostat is intermittent:
  - Whether THERMO ON is to continue or not depends on the thermal condition when the 3-minute forced operation ceases.
  - ① "THERMO ON continues" when room temperature  $\geq$  setting temperature  $+1^{\circ}\text{C}$ : (The THERMO operation value is usually the same as that at "start of operation")
  - ② "Forced THERMO OFF" when room temperature  $<$  setting temperature  $+1^{\circ}\text{C}$ : (The same THERMO operation value as that at "start of operation" is usually used for recovery)
 Therefore, if the air-conditioner is stabilized under this thermal condition, it will enter intermittent operation, which is "3-minute operation/3-minute stop".
- (6) Compressor speed is determined by instruction sent from indoor unit and corrected by outdoor unit according to such factors as capacity, fan speed, number of units being operated, outdoor temperature, etc.

## Dehumidifying Sleep Operation

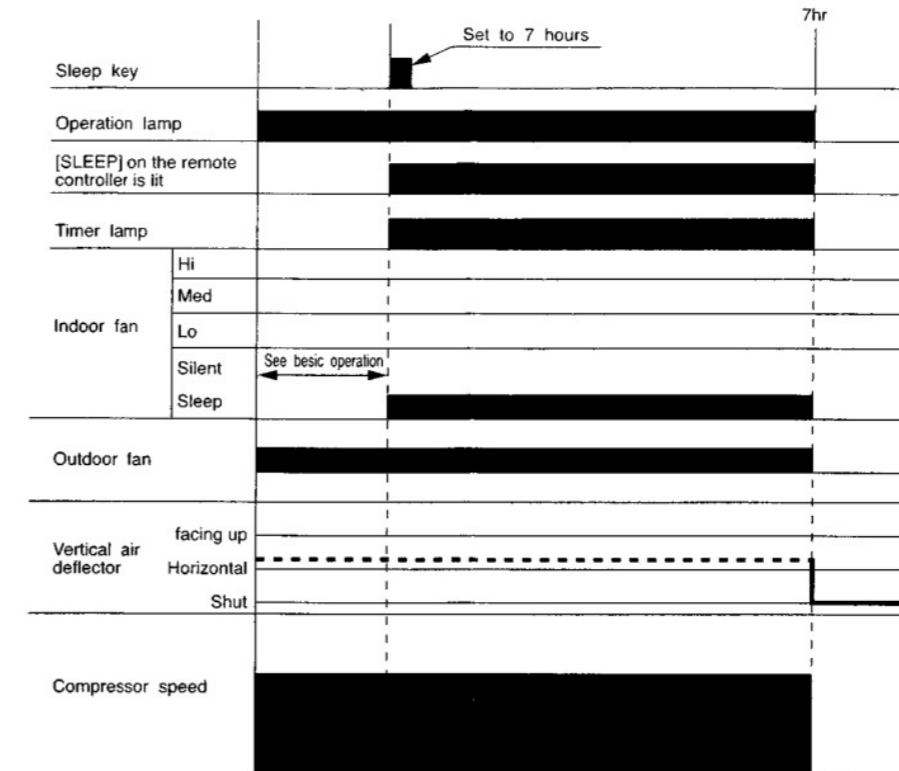

### Notes:

- (1) The sleep operation starts when the sleep key is pressed.
- (2) When the sleep key is set, the indoor fan is set to "sleep silent" (FDOY\_M).
- (3) The indoor fan speed does not change even when the fan speed mode is changed.
- (4) If the set time is changed during sleep operation, all data including set temperature, time, etc. is cleared and restarted.
- (5) If sleep operation is canceled by the cancel key or sleep key, all data is cleared.
- (6) If the position of air deflector is being operated using remote control, the operation will be performed at any desired position of air deflector.

## Basic Heating Operation

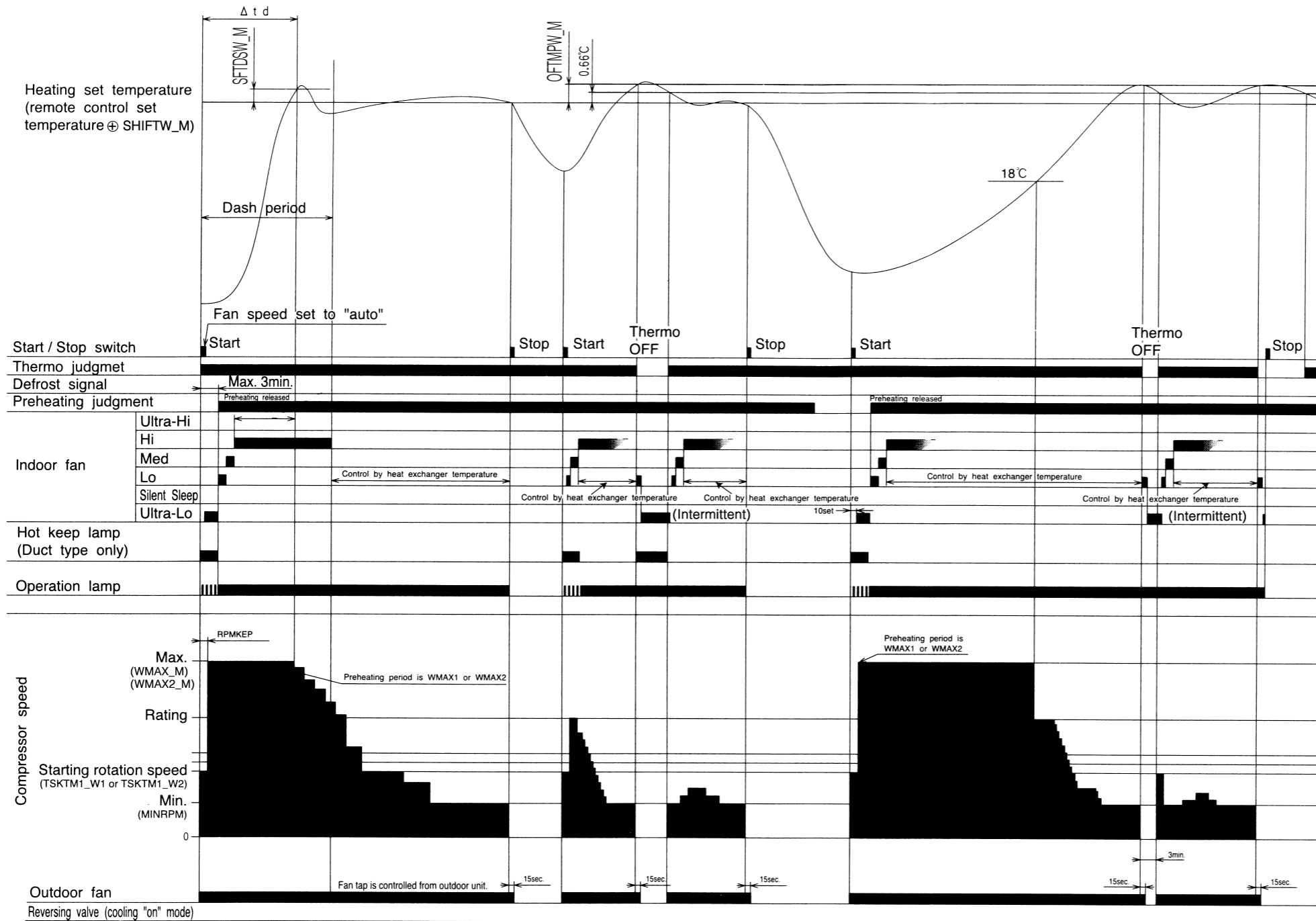

### Notes:

- (1) Hot Dash is started when the operation is started at fan speed "AUTO" or "HI" or when the fan speed is changed to "AUTO" or "HI" during heating operation, and when the compressor speed (P item) reaches (WMAX\_M or WMAX2\_M) or higher with the room temperature at 8°C or less and outdoor temperature at 10°C or less.
- (2) The maximum compressor speed period during hot dash is finished (1) when the room temperature reaches the heating set temperature (including heating shift) plus SFTDSW\_M or (2) when the thermo is off.
- (3) The thermo OFF temperature during hot dash is heating set temperature (including heating shift) plus 3°C. After thermo OFF, hot dash finishes, and PI control starts.
- (4) The compressor minimum ON time and minimum OFF time is 3 minutes.
- (5) The time limit for which the maximum compressor speed (WMAX\_M or WMAX2\_M) during normal heating (except for hot dash) can be maintained is less than 120 minutes when the room temperature is 18°C or more; it is not provided when the room temperature is less than 18°C and outdoor temperature is less than 4°C.
- (6) The operation indicator will blink every second during initial cycle operation, preheating, defrosting (including balance time after defrost is finished), or auto fresh defrosting. However, with duct type models, operation indicator does not blink, but Hot Keep indicator will light. And Hot Keep indicator will also light in "Thermo OFF" mode.
- (7) For preheating judgment, preheating starts if the heat exchange temperature is lower than YNEOF\_M and is cancelled if the heat exchange temperature is YNEOF\_M plus 0.33°C or higher at the start of operation using the START / STOP button.
- (8) If the room temperature falls to less than 18°C in the "Ultra-Lo" mode, the indoor fan stops. When the room temperature is 18°C+0.33°C or more, the ultra-Lo operation restarts. However, the ultra-Lo operation during preheating or preheating after defrosting does not stop if the room temperature is less than 18°C.
- (9) Compressor speed is determined by instruction sent from indoor unit and corrected by outdoor unit according to such factors as capacity, fan speed, number of units being operated, outdoor temperature, discharge pressure etc.
- (10) If another indoor unit is doing cooling operation, dehumidifying operation or fan operation, heating operation cannot be done.
- (11) Indoor fan will reduce 1 step lower if heat exchanger thermistor sense lower temperature than default setting. Indoor fan resume to initial setting once heat exchanger thermistor sense above than default setting.

## Heating Sleep Operation

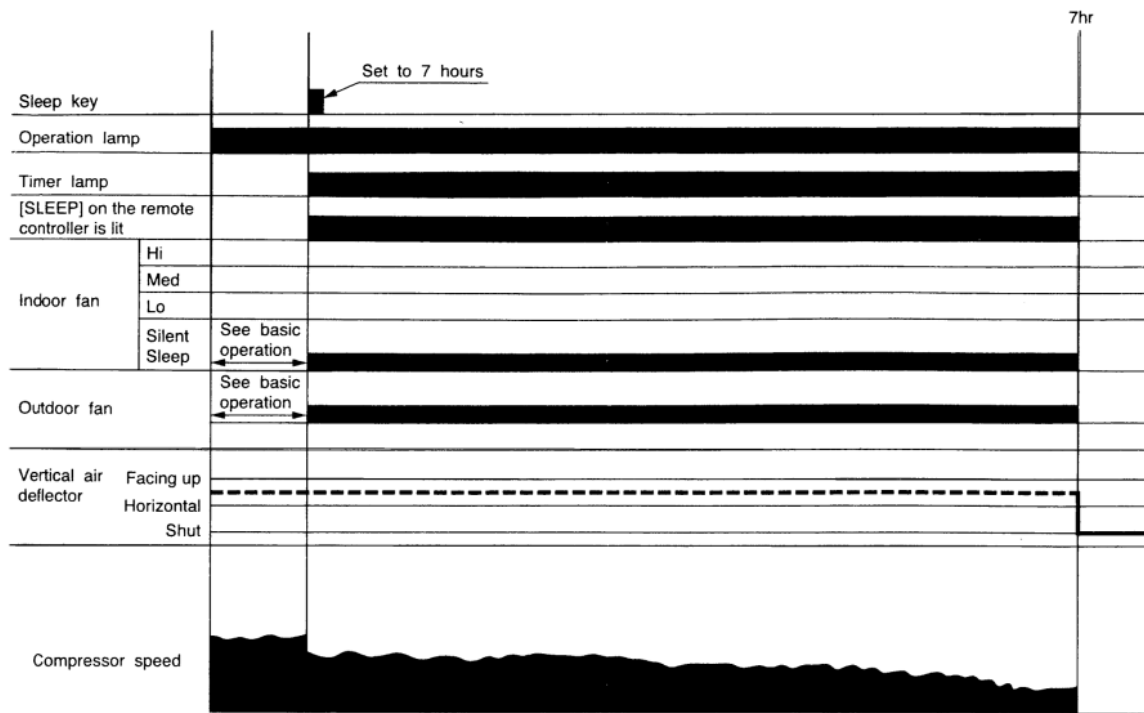

**Notes:**

- (1) The sleep operation starts when the sleep key is pressed.
- (2) When the sleep key is set, the indoor fan is set to "Sleep Silent" (FWSOY\_M).
- (3) The indoor fan speed does not change even when the fan speed mode is changed.
- (4) When defrosting is to be set during sleep operation, defrosting is engaged and sleep operation is restored after defrosting.
- (5) If the set time is changed during sleep operation, all data including set temperature, time, etc. is cleared and restarted.
- (6) If sleep operation is canceled by the cancel key or sleep key all data is cleared.
- (7) If the position of air deflector is being operated using remote control, the operation will be performed at any desired position of air deflector.

**NOTE:**

1. Refer to the PWRITE-ZU data for the constats expressed by capital alphabet letters in the drawing.

## Clean Operation

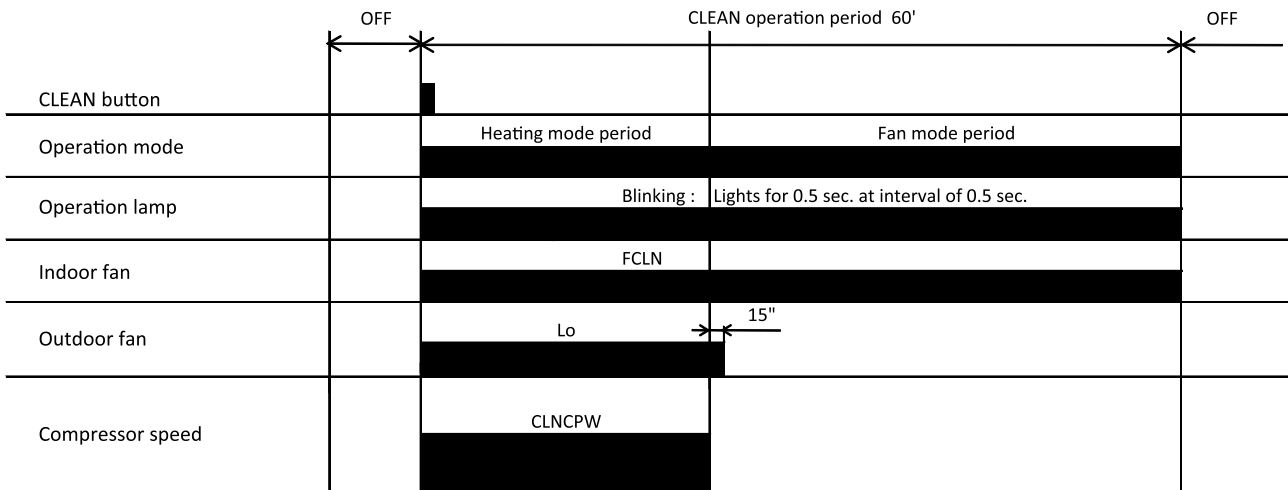

Notes :

- (1) During CLEAN operation period, heating mode will change to fan mode when HEX temperature is "CLNEVP" or more except force 3 minutes operation.
- (2) For multi connections, CLEAN operation is limited to fan mode.

## Leave Home

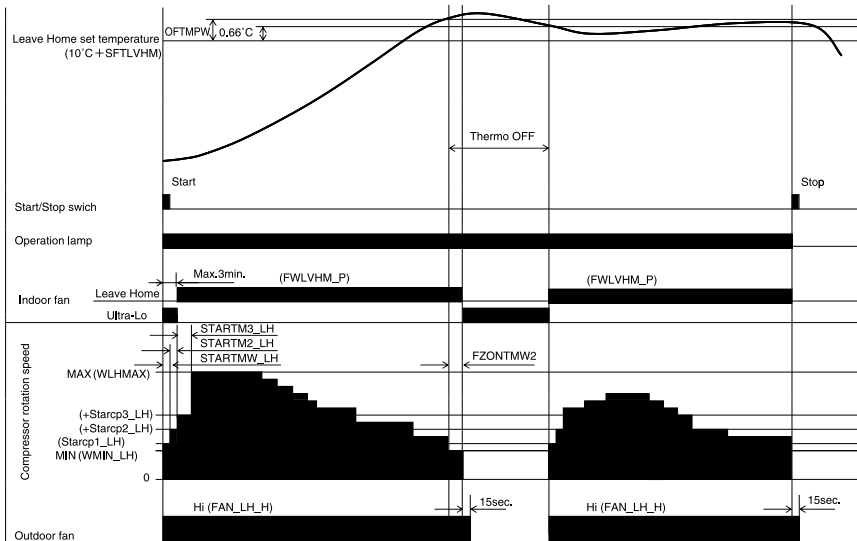

Notes:

Perform Leave Home operation according to the following control contents.

- |  |  |
|--|--|
| ① Operation mode : Heating                           | ⑥ Compressor start control : Set the start control using the special value for the Leave Home mode.  |
| ② Temperature set : 10°C                             | ⑦ Compressor rotation speed : Upper limit speed by fuzzy control 『WLMAX』<br>Lower limit speed by fuzzy control 『WMIN_LH』   |
| ③ Temperature setting correction shift : + 『SFTLVHM』 | ⑧ Operation lamp : The timer lamp lights up when the timer for the desired number of days is set.  |
| ④ Indoor fan : 『FWLVHM_P』                            | ※ The vertical air deflection plate is initially operated when the Leave Home mode is activated;<br>this serves as a notification that the Leave Home mode has been set. |
| ⑤ Outdoor fan : 『FAN_LH_H』                           |  |

# REFRIGERATING CYCLE DIAGRAM

MODEL RAD-18QPB  
RAD-25QPB  
RAD-35QPB

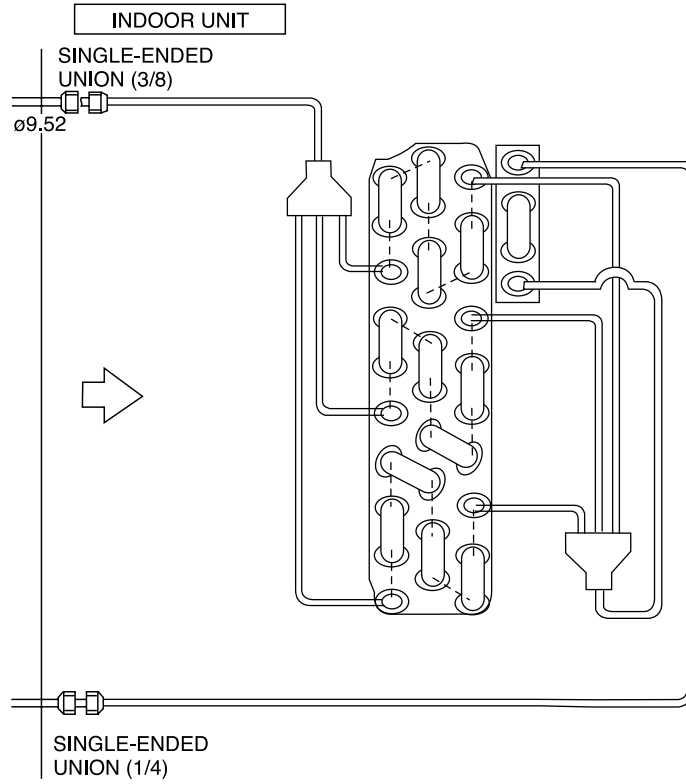

MODEL RAD-50QPB

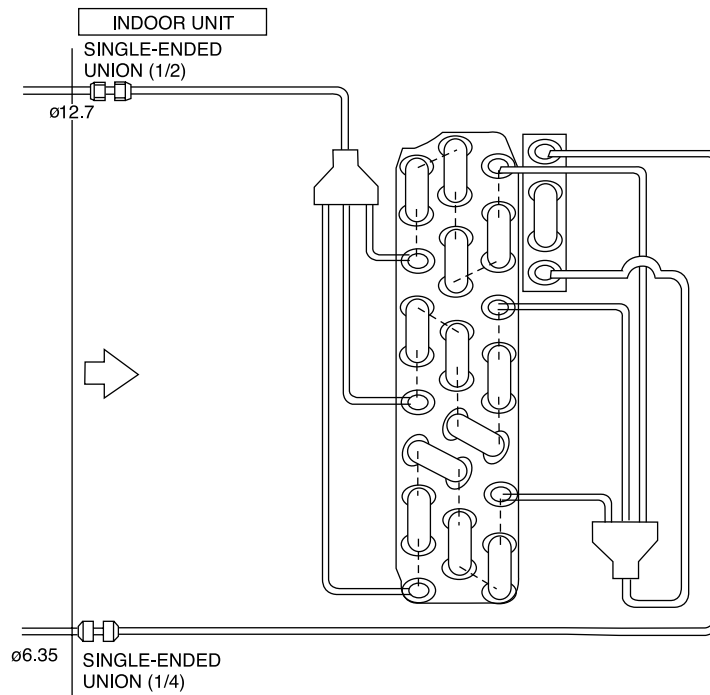

# DESCRIPTION OF MAIN CIRCUIT OPERATION

## ■ RAD-18QPB, RAD-25QPB, RAD-35QPB, RAD-50QPB

### 1. Power control circuit

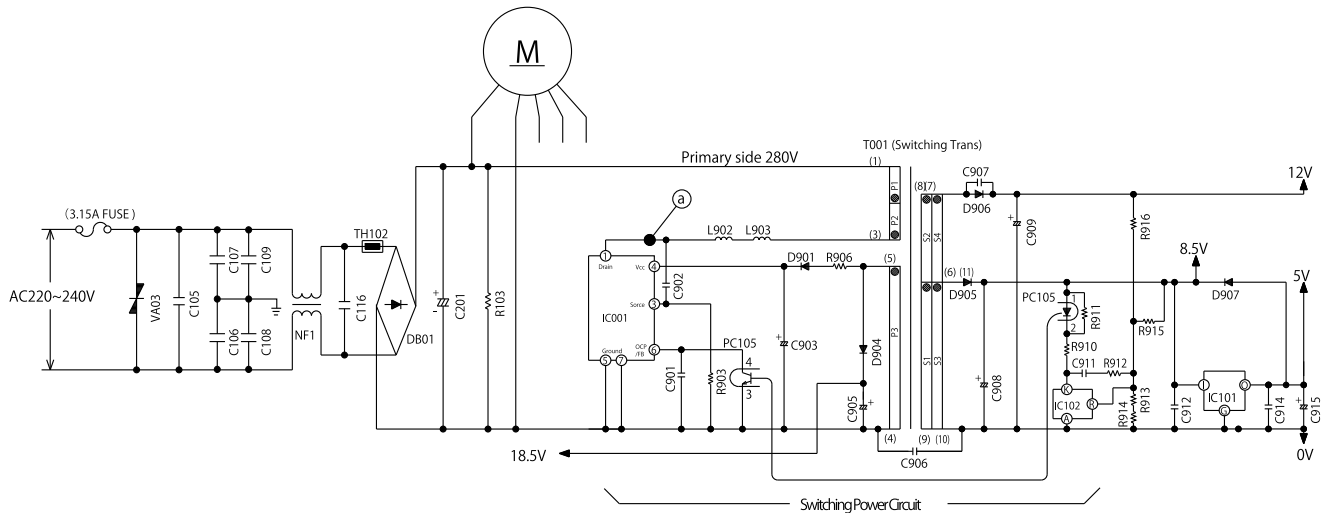
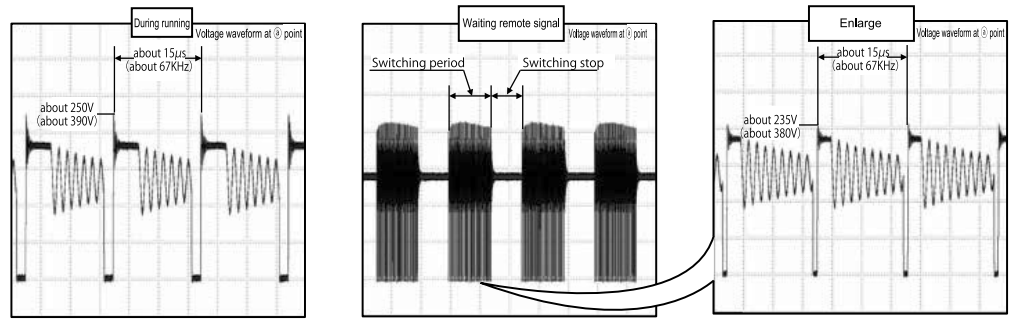

Fig. 1-1

- An AC power supply from outdoor unit flow through the 3.15A fuse, varistor (VA03), then filtered by noise filter circuit, rectified and smoothed by DB01 and C201 to a DC current 311V to 325V. Then it is supplied to the indoor fan motor drive circuit and switching power circuit.
- The switching power circuit, as controlled by IC001, drives the primary winding of the transformer (T001) to produce a specified voltage at the output winding. [The output terminal (pin ①) of IC001 has a switching voltage as shown in Fig. 1-1 but it changes in voltage peak and oscillation period depending on the power load. While on standby for a remote control signal, in particular, the oscillation frequency is lowered to a level as low as 20 kHz or so to reduce the standby power.]
- The outputs of the output windings of the transformer is rectified and smoothed to become DC voltages at primary 18.5V, 12V, and 8.5V respectively. The primary 18.5V is supplied to the drive circuit of the indoor fan motor, the 12V is supplied to each vane motor and to the drive circuits of the cleaning unit driving motor and other equipment, and the 8.5V is adjusted to a stable 5V by the 3-terminal regulator IC (IC101) and supplied to the microcomputer peripheral circuit.

#### Check

If a failure in a part or circuit has produced an abnormal current in the power supply, the 3.15A fuse will blown to prevent further damage. If the 3.15A fuse blown, check the indoor fan motor, switching electrical circuit, and other components and replace any defective part.

#### Check

If an abnormally high voltage is applied to the power supply, the 3.15A fuse and varistor (VA03) will prevent further damage. If a high voltage results in the 3.15A fuse blown, the varistor (VA03) should have deteriorated and destroyed. Therefore replace it at the same time.

#### Caution

The primary circuit of the transformer (T001) has a voltage to ground. Guard against electric shocks.

#### Caution

Even the breaker is OFF, the high voltage is still exist on the board. Make sure to wait for 15 minutes or more before start the part replacing work.



## 2. Drive circuit of the indoor fan motor

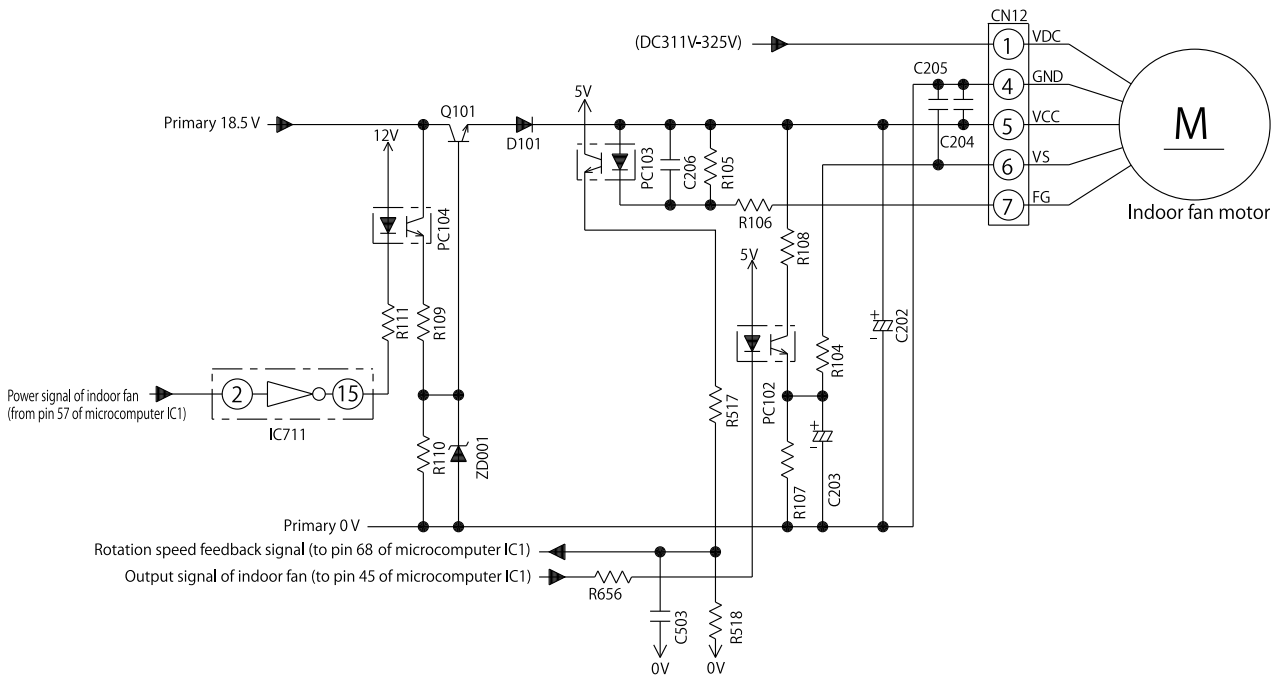

Fig. 2-1

< Typical circuit waveform >

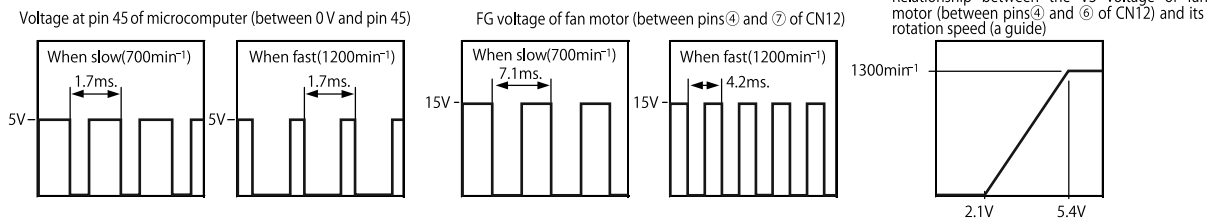

Fig. 2-2

- The indoor fan motor DC Voltage (VDC), Control Circuit Voltage (VCC), and Speed Control Voltage (VS) are supplied from connector CN12. FG is a feedback signal for an indoor fan motor frequency of rotation speed.
- Primary 18.5V flows through a converter circuit and steps down to 5V.
- While the remote control signal is on Standby, the Q101 acts as a switch and cuts off the supply for VCC. Hence it will reduce power consumption during standby.
- The VS is controlled by the microcomputer (IC1). The VS terminal undergoes an analog voltage that matches the LO pulse signal at pin 45 of the microcomputer (IC1). (See Fig. 2-2.)
- The FG feedback signal sends 12 pulses per revolution of the motor shaft. By counting the pulse frequency rate, the microcomputer (IC1) recognizes the motor speed, thereby performing feedback control.

### Caution

The indoor fan motor and drive circuit are connected to the primary power supply. Do not perform safe work practice to avoid electric shock.

### Caution

Do not plug/unplug the connector when the unit is powered ON. Doing so may cause the indoor fan motor and board circuit to be damaged. Perform the repair work after sufficiently discharging. Insufficient capacitor discharge may cause an electric shock.

### 3. Remote control reception circuit

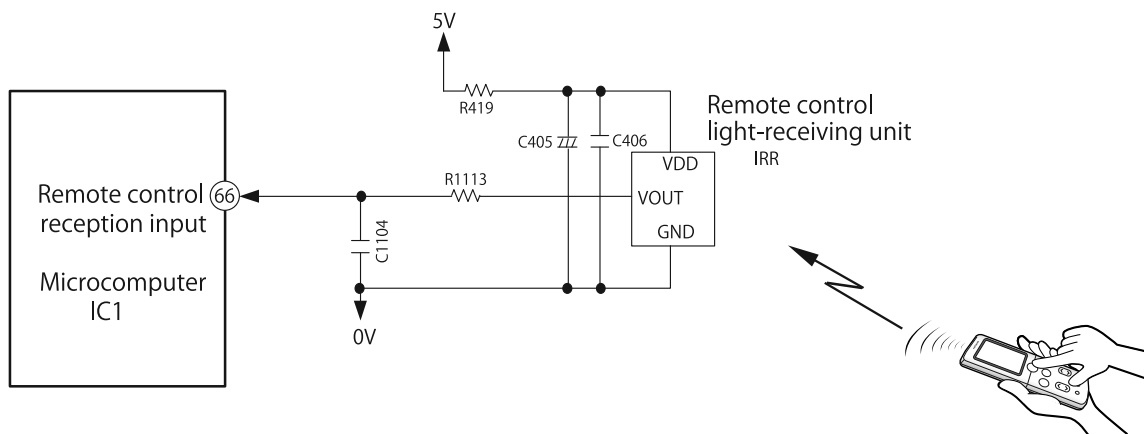

Fig. 3-1

[Typical communication waveform]

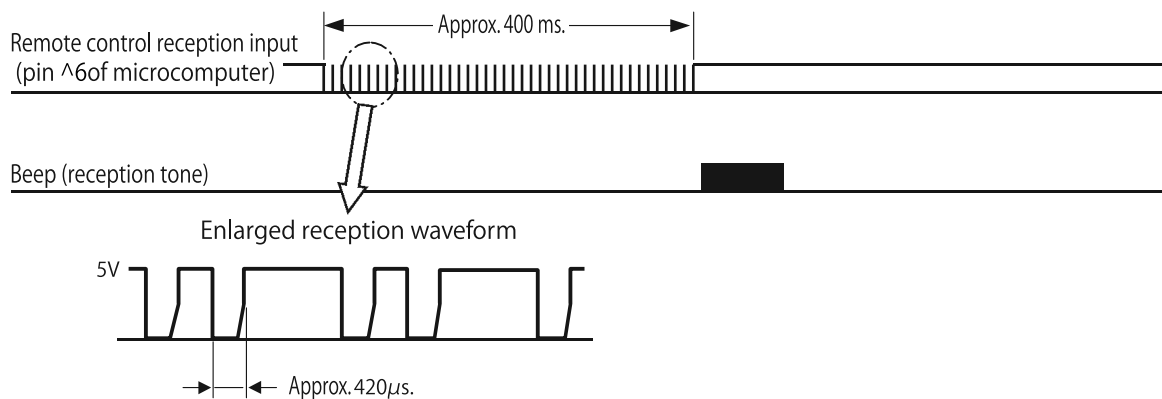

Fig. 3-2

- An infrared signal from the remote control unit is converted to an electrical signal by Remote Control Light-Receiving Unit (IRR) and send to microcomputer (IC1). Data is transmitted in digital data "0" and "1" by changing the interval of the basis pulses at about 420 $\mu$ s.

#### 4. Indoor/outdoor communication circuit

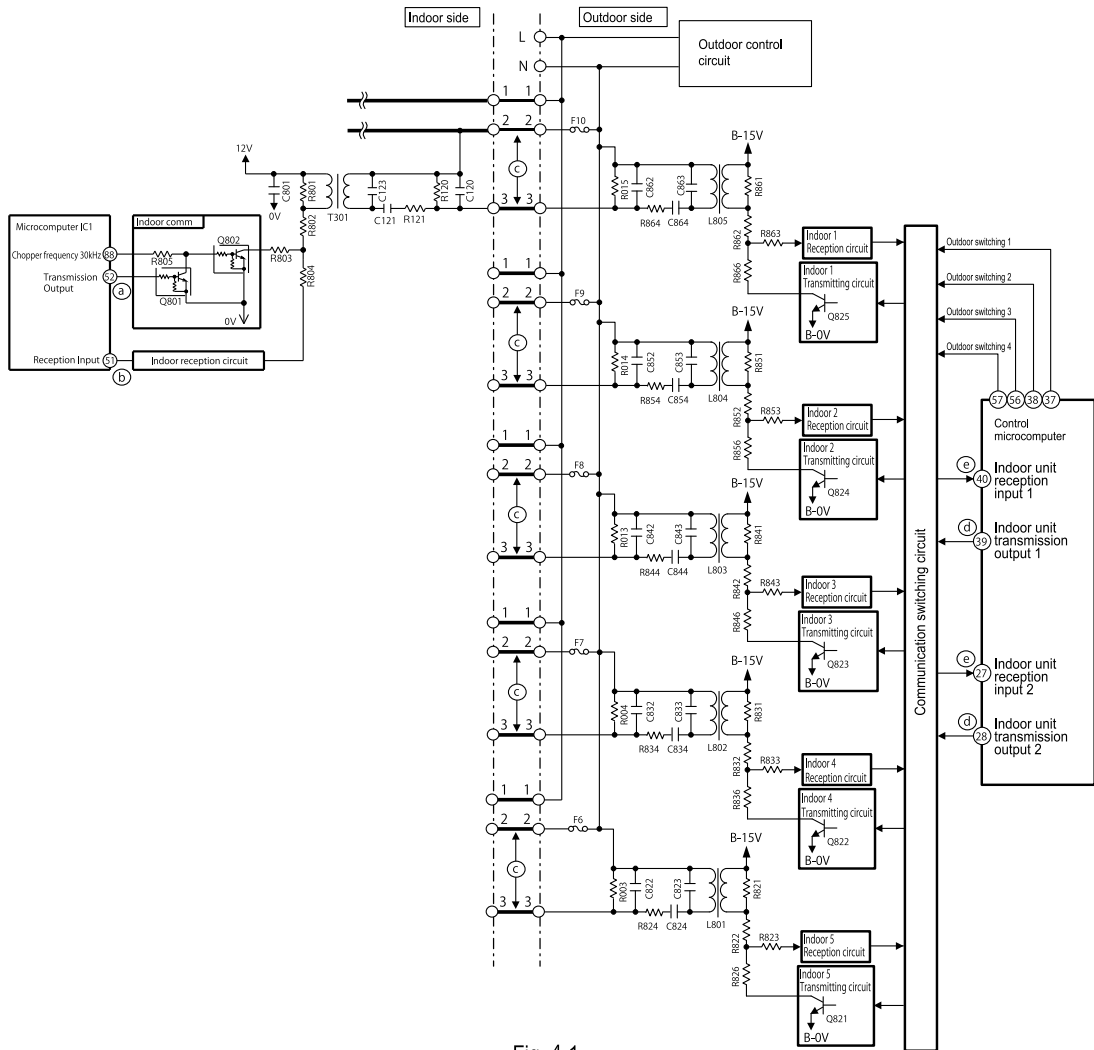

Fig. 4-1

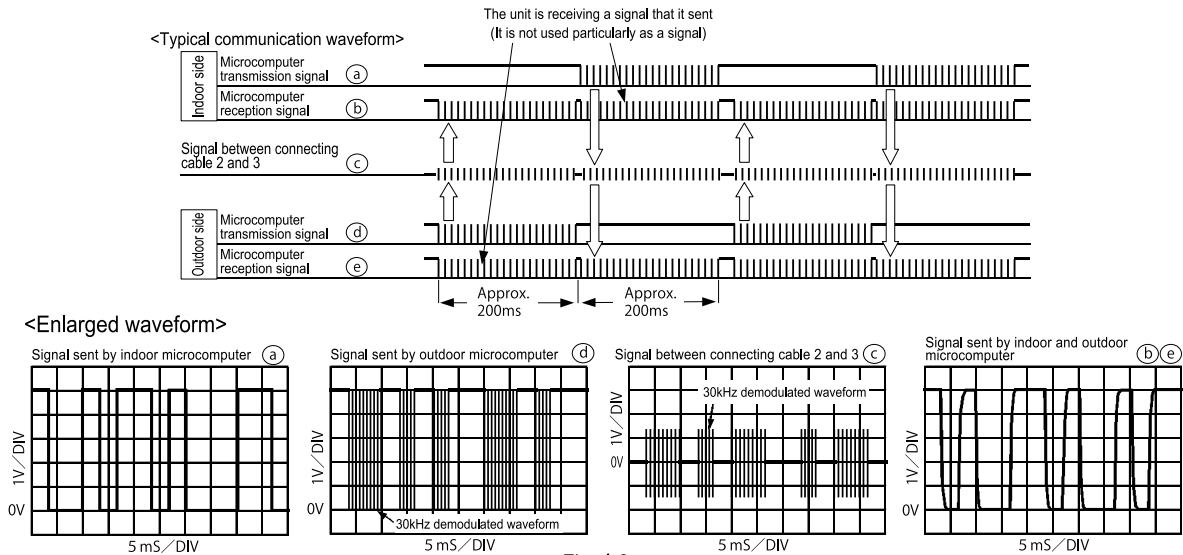

Fig. 4-2

- \* Indoor and outdoor communications are conducted by using lines 2 and 3 of connecting cable. Line 2 of connecting cable is share with a transmission channel that powers the indoor unit.
- \* Data communicated between the indoor and outdoor units are outputted from the microcomputer as serial signals and are transmitted as demodulated by a 30kHz carrier wave.

#### Check

If the communication fails between the indoor and outdoor units for some reason, the product will give a self-diagnosis display either by “the timer lamp blinking 3 times” or “the the timer lamp blinking 12 times” depending on the cause.

## 5. Room temperature heat exchanger thermistor circuit

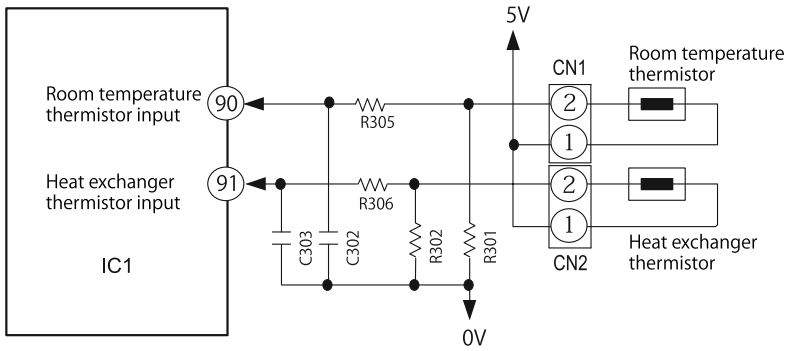

Fig. 5-1

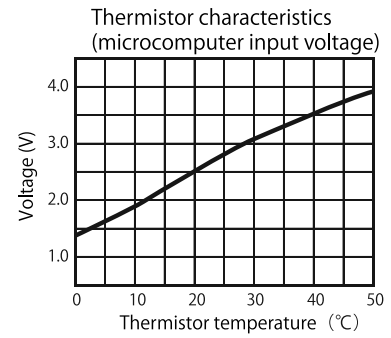

Fig. 5-2

- The room and indoor heat exchanger pipe temperature are detected by Room Temperature Thermistor and Heat Exchanger Thermistor.
- A thermistor is an electrical resistor whose resistance is reduced by the heat. Analog voltages obtained by the resistance voltage is divided with the fixed resistor recognized by the microcomputer (IC1) as temperature signals.
- The relationship between the thermistor temperature and circuit voltage is roughly as shown in Fig. 5-2. If it is easier to take actual measurements between the terminals of CN1 and CN2, refer chart in Fig. 5-3 "Voltages between Thermistor ends."

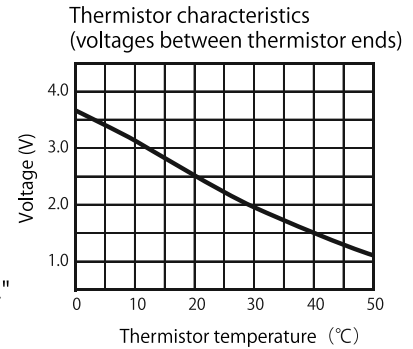

Fig. 5-3

## 6. Float switch

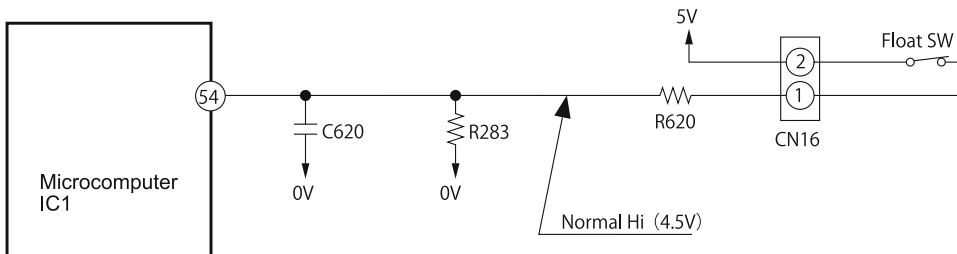

Fig. 6-1

- It is a float type switch used to observe the drain water level in the drain pan. This switch will be activated and forced the unit to stop when abnormal water level is detected caused by drain pump broken or blocked drain hose failed to suck the water out.
- During float switch operated, timer lamp will blink 6 times. Please take note that the switch will also activated when float switch connector is not inserted properly of the lead wire is shorted.

## 7. Drain pump driven circuit

- During cooling and dry mode, microcomputer pin 85 will become Hi and turned ON the drain pump relay to driven the drain pump motor.

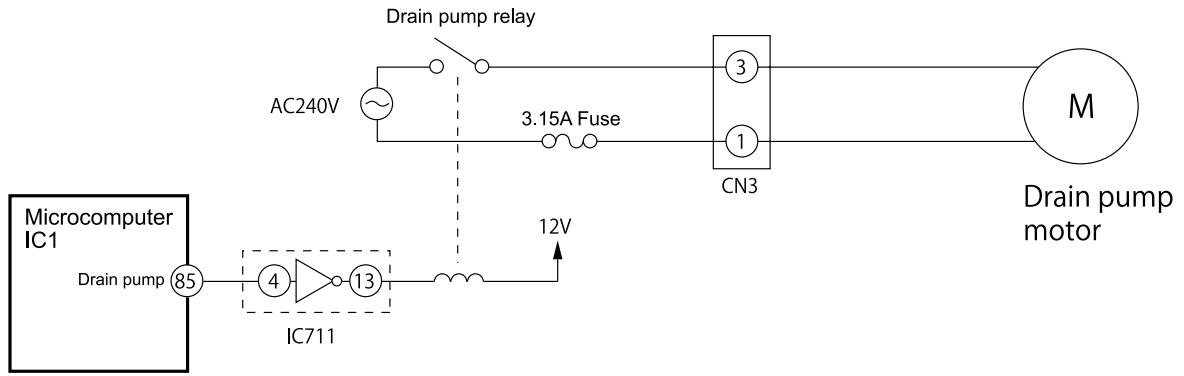

Fig. 7-1

## 8. Drain pump test switch

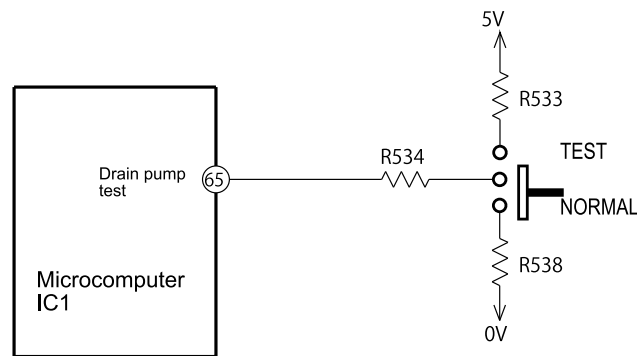

Fig. 8-1

- It is a switch to turn ON the drain pump for testing purpose. When select the switch to test position, drain pump motor will operate and timer lamp will blink 7 times. During this time, remote control signal will not receive.

## 9. High static pressure switch (Full duct type and semi duct type)

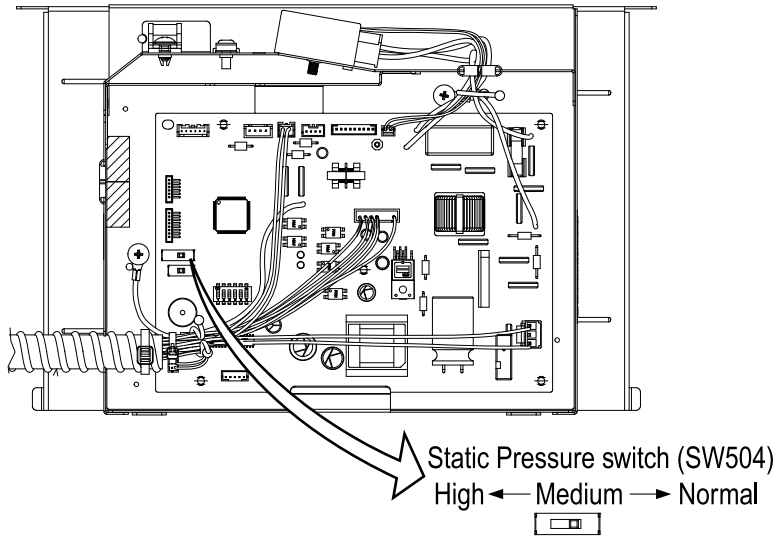

Fig. 9-1

- For full duct type, set the switch to High position. For semi duct type, set the switch to Medium position.
- If not set to High or Medium, there will be reduction of cooling and heating capacity.

## 10. Wired remote control reception and transmission circuit.

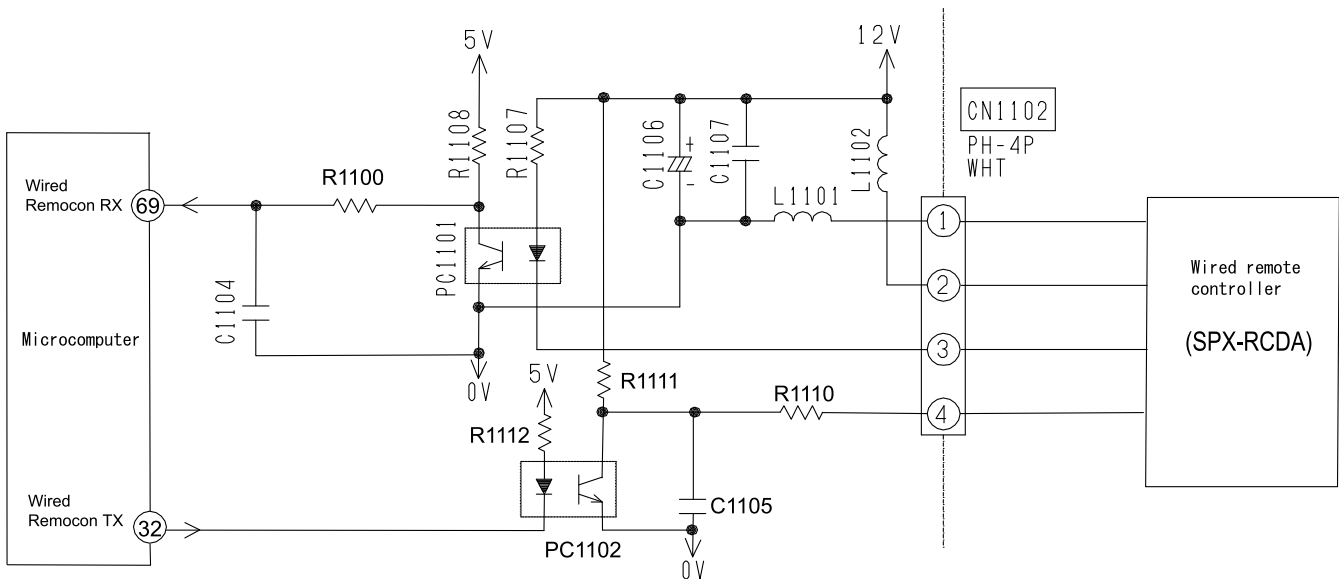

Fig. 10-1

- In wired remote control circuit, the signal will transmit to microcomputer pin 69 by using photocopier PC1101 and receive from microcomputer pin 32 by using photocopier PC1102.

## 11. Dip switch

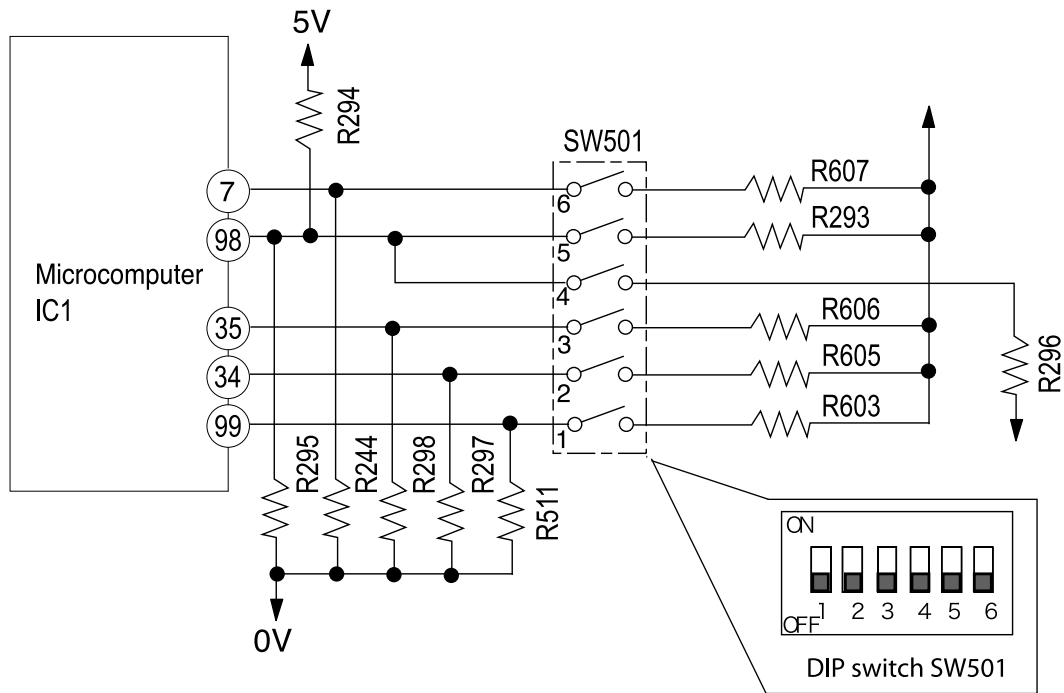

Fig. 11-1

- Fig.11-1 shows the dip switch circuit. The table shown in Fig.11-2 are function and setting position from ① - ⑥ of the switch number.

SW No.	ITEM	FUNCTION							
		OFF	ENABLE	ON	DISABLE				
1	AUTO RESTART	OFF	ENABLE	ON	DISABLE				
2	CARD KEY MODE	OFF	DISABLE	ON	ENABLE				
3	CARD KEY LOGIC SELECT	OFF	INPUT HIGH ACTIVE	ON	INPUT LOW ACTIVE				
4	HEATING/COOLING ONLY MODE SELECT	OFF	HEATING & COOLING	OFF	HEATING ONLY	ON	COOLING ONLY	ON	HEATING & COOLING
5	HEATING/COOLING ONLY MODE SELECT	OFF		ON		OFF		ON	
6	NOT USED								

Fig. 11-2

### NOTE :

1. All switch set to OFF position (Factory setting).
2. If the dip switch set to "Heating mode only" or "Cooling mode only", the wireless remote controller must be set to operation mode lock setting as indicated on page 119.

# SERVICE CALL Q & A

Model RAD-18QPB, RAD-25QPB, RAD-35QPB, RAD-50QPB

## COOLING MODE

**Q1** The compressor has stopped suddenly during cooling operation.



**A1** Check if the indoor heat exchanger is frosted. Wait for 3-4 minutes until it is defrosted.

If the air conditioner operates in cooling mode when it is cold, the evaporator may get frosted.

## DEHUMIDIFYING MODE

**Q2** Sound of running water is heard from indoor unit during dehumidifying.



**A2** Normal sound when refrigerant flows in pipe.

**Q3** Compressor occasionally does not operate during dehumidifying.



**A3** Compressor may not operate when room temperature is 10°C or less. It also stops when the humidity is preset humidity or less.

## HEATING MODE

**Q4** The circulation stops occasionally during Heating mode.



**A4** It occurs during defrosting. Wait for 5-10 minutes until the condenser is defrosted.

**Q5** When the fan speed is set at HIGH or MED, the flow is actually Weak.



**A5** At the beginning of heating, the fan speed remains LOW for 30 seconds. If HIGH is selected, it switches to LOW and again to MED after additional 30 seconds.

**Q6** Heating operation stops while the temperature is preset at "30".



**A6** If temperature is high in the outdoor, heating operation may stop to protect internal devices.



## AUTO FRESH DEFROSTING

**Q7** After the ON/OFF button is pressed to stop heating, the outdoor unit is still working with the OPERATION lamp blinking.



**A7** Auto Fresh Defrosting is carried out : the system checks the outdoor heat exchanger and defrosts it as necessary before stopping operation.

## AUTO OPERATION

**Q8** Fan speed does not change when fan speed selector is changed during auto operation.



**A8** At this point fan speed is automatic.

## INFRARED REMOTE CONTROL

**Q9** Timer cannot be set.



**A9** Has the clock been set? Timer cannot be set unless the clock has been set.

**Q10** The current time display disappears soon.



**A10** The current time disappears in approx. 10 seconds. The time set display has priority.

When the current time is set the display flashes for approx 3 minutes.

**Q11** The timer has been programmed, but the preset time disappears.



**A11** Is the current time past the preset time? When the preset time reaches the current time, it disappears.

## OTHERS

**Q12** The indoor fan varies among high air flow, low air flow and breeze in the auto fan speed mode. (Heating operation)



**A12** This is because the cool wind prevention function is operating, and does not indicate a fault.

The heat exchanger temperature is sensed in the auto speed mode. When the temperature is low, the fan speed varies among high air flow, low air flow and breeze.

**Q13** Loud noise from the outdoor unit is heard when operation is started.



**A13** When operation is started, the compressor rotation speed goes to maximum to increase the heating or cooling capability, so noise becomes slightly louder. This does not indicate a fault.

**Q14** Noise from the outdoor unit occasionally changes.



**A14** The compressor rotation speed changes according to the difference between the thermostat set temperature and room temperature. This does not indicate a fault.

**Q15** There is a difference between the set temperature and room temperature.



**A15** There may be a difference between the set temperature and room temperature because of construction of room, air current, etc. Set the temperature at a comfortable for the space.

**Q16** Air does not flow immediately after operation is started.



**A16** Preliminary operation is performed for one minute when the power switch on and heating or dehumidifying is set. The operation lamp blinks during this time for heating. This does not indicate a fault.

# TROUBLE SHOOTING

MODEL RAD-18QPB, RAD-25QPB, RAD-35QPB, RAD-50QPB

## Inspection instructions



### Warning

Note that the 0V line of the outdoor electrical parts and the primary power circuit of the indoor electrical parts have voltages to ground as illustrated in the right-hand figure.

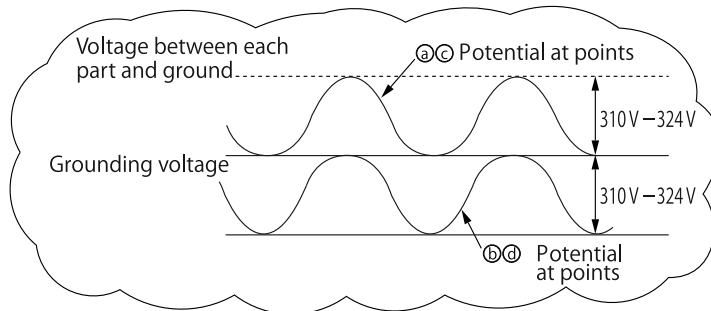
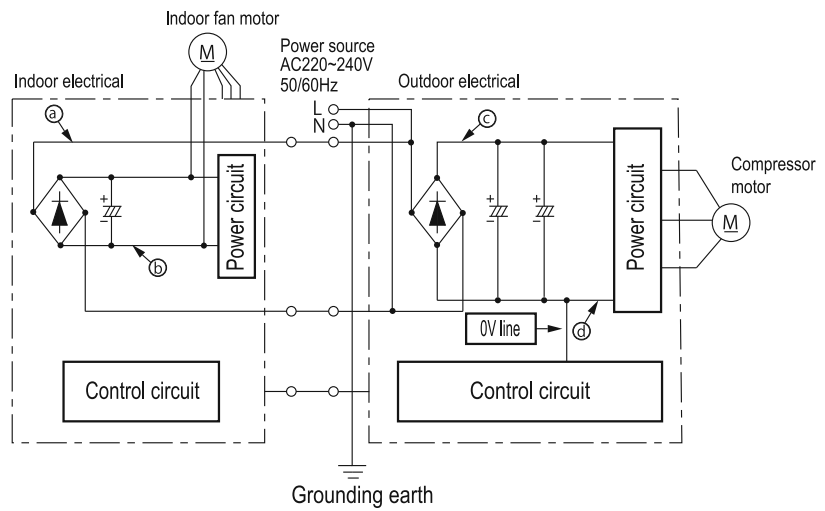

### Warning

When conducting a check with an oscilloscope or something similar, do not ground the oscilloscope. Note that the oscilloscope will be subjected to voltages as illustrated in the figure above.

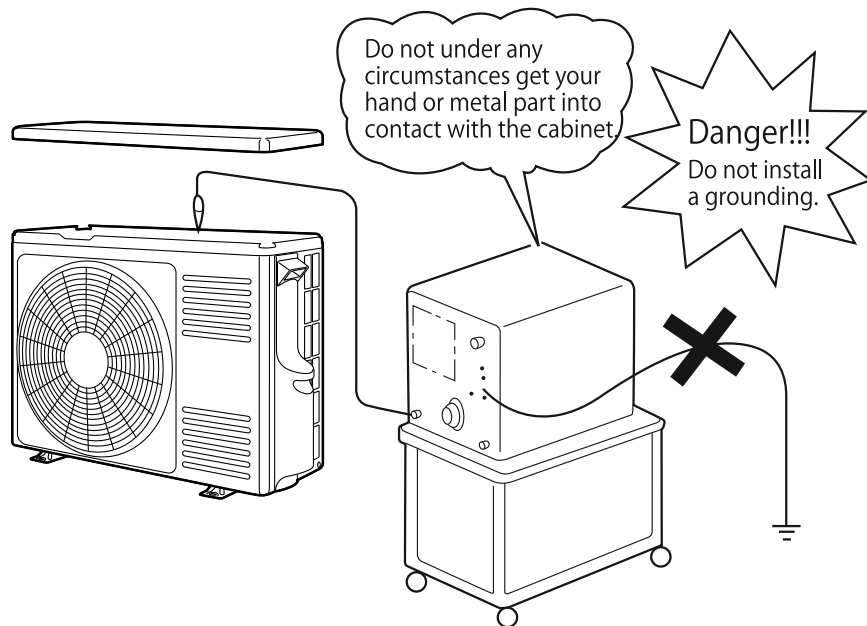

No.	Function	Description	See page
1	Self-diagnosis display [Display on the indoor unit side]	<ul style="list-style-type: none"> <li>• The failure mode detected on the indoor unit side is displayed by blinking of the "timer lamp".</li> <li>• If the outdoor unit side detects a failure, the product will first conduct several operation retry and then blink the "timer lamp" 4 times. There are some failure modes with no lamp display while retry are continued. Then if want to continue further checking based on self-diagnosis method "operation lamp" will blinking. [Failure mode where retry are continued and the indoor unit lamp does not end up giving a error display]</li> <li>• Compressor body temperature rise</li> <li>• Fan stop due to heavy wind</li> <li>• Things with low incident to happen</li> <li>• Supply voltage error</li> </ul>	95
	[Display on the outdoor unit side]	<ul style="list-style-type: none"> <li>• The failure mode detected on the outdoor unit side is displayed by blinking the "LD351" or "LD352". Detecting a failure will stop the outdoor unit and keep blinking the "LD351" or "LD352" until it is restarted. (The communication error will persist until the communication is reestablished.)</li> </ul>	Refer outdoor unit service manual.
2	Self-diagnosis memory	<ul style="list-style-type: none"> <li>• The failure modes detected on the indoor and outdoor unit sides are stored in the nonvolatile memory of the indoor unit and can be read later on. (The memory will remain even after power-off.)</li> <li>• The failure modes detected on the outdoor unit side are written in memory every time any such mode occurs. The failure mode can therefore be detected on the indoor unit side without waiting for the retry frequency to reach the display of the indoor unit lamp. Moreover, the normal self-diagnosis display function which rarely occurs will store and display failure modes that do not end up displaying the indoor unit lamp. (Any such mode may be unable to be stored if indoor or outdoor communications is in a failure.)</li> <li>• The product stores 5 last-stored failure modes.</li> <li>• There is a function for deleting memory. Once you clear the memory and run the product for several days, you can read the failure modes and check them, thereby detecting the less frequent failure phenomena.</li> <li>• Failure modes can be checked by both the blinking of the lamp of the indoor unit and the display of the remote control liquid crystal display.</li> </ul>	96

※The "self-diagnosis function of the communication circuit" available in our conventional models is now incorporated as part of the normal self-diagnosis function. In the case of a failure in the communication circuit, you do not have to conduct a special operation and the operations can be automatically divided into 3 blinking operations and 12 blinking operations of the timer lamp. However, a strong external noise may have resulted in 12 times of blinking.

## Self-diagnosis display function (indoor side display)

In case the "timer lamp" (green) or the "operation lamp (yellow) of the indoor unit is blinking, troubleshoot the product while referring to the table below.

### 1. Method to count the lamp blinking times.

- Blinking will repeat with 2s of interval time.
- Blinking speed will be lit for 0.35s and off for 0.35s.

<Example of 5 times blinking>



### 2. If you wish to try another operation while the lamp is blinking, press the START/STOP button on the remote control unit twice. The first press will reset the microcomputer while the second will activate the unit. (Except for mode※1)

<Caution>

- There is a failure mode displayed only while the self-diagnosis memory is read. (※2)  
Read and check it as necessary.
- An error connection (wrong insertion) of terminal 1 or 2 of connecting cable may go undetected.
- Please confirm operation lamp blinking before proceed to self-diagnosis re-displayed. (※3)
- In case all indication lamp blink
- There is a possibility 100V had been supplied to outdoor unit. Check supply voltage with tester and do repair as below table.

Check Point	Repair or replace part
• Less than 100V supplied.	• Not a failure. Please repair the power supply.
• 220~240V supplied.	• Outdoor electrical part abnormal. Please replace outdoor electrical part.

Blink lamp	Blinks	Check Point	Action	Remark	
Timer Lamp (green)	1	•Reversing valve or related circuit. •Refrigerant cycle abnormal or leak.	•Refer outdoor self-diagnosis. •Check refrigerant cycle.		
	2	•Forced cooling in operation.	•Not a failure.		
	3	•Indoor communication circuit error.	•Replace indoor main PWB.		
	4	•Check failure indication of outdoor unit or failure mode redisplayed.	•Refer table on the right.	※3	
	6	•Abnormal water level detected.	•Check drain pump or drain pan.		
		•Float switch connector bad insertion or wire shorted.	•Securely connect CN22 connector.		
	7	•Drain pump test in operation.	•Not a failure.		
	9	•Connector for room thermistor or heat exchanger thermistor not connect properly or thermistor wire broken or shorted.	•Securely connect CN1 and CN2 connector.		
		•Check terminal board fuse. (Mis-connection of connecting cable might blow the fuse)	•Replace terminal board. •Securely connect the connecting cable.		
	10	•Fan motor connector disconnected.	•Connect securely CN12.		
		•Fan motor lock mechanically.	•Adjust the locking position.		
		•Fan motor broken.	•Replace new fan motor.		
	12	•Connecting cable wrong insert.	•Reconnect cable.		
•Outdoor communication circuit failure.		•Refer outdoor self-diagnosis for detail.			
•Outdoor CN30 forgot to connect.		•Securely connect CN30 connector.			
13	•EEPROM or Microcomputer defect.	•Replace indoor main PWB.	※1		



Blink lamp	Blinks	Check Point	Action	Remark
Operation Lamp (yellow)		Outdoor failure indicate as below when operation lamp blink. Detail shall refer to lamp label attached.		
	2	Peak current cut.		
	3	Abnormal low speed rotation.		
	4	Switching failure.		
	5	Overload lower limit cut.		
	6	Compressor body temperature rise.		※2
	7	Outdoor thermistor abnormal.		
	8	Communication error between micon.		
	9	Indoor unit type mismatch.		
	10	Power voltage error.		※2
	11	Fan stop due to heavy wind.		※2
	12	Fan lock stop.		
	13	EEPROM read error.		
	14	DC voltage abnormal.		
	15	ACT circuit abnormal.		
Totally no operation.		•FU1 3,15A fuse blown	•Replace fuse or other part that causing the fuse blown.	
		•Receiver PWB connector disconnected.	•Securely connect connector CN11A.	
		•Card-key selection [yes] condition.	If not using card-key function, make sure to turned OFF the switch SW501 setting of main PWB.	
		•Indoor PWB defect.	•Replace indoor PWB.	





## SELF-DIAGNOSIS MEMORY FUNCTION



Failure modes are stored in the nonvolatile memory of indoor unit and shall be redisplayed by remote controller.

This function is useful in checking the failure modes either during switching OFF the power or restarting the device without checking the number of indication lamp blinking. Remote controller can redisplay up to last 5 failure modes from the memory. However, failure modes which are rarely to occur are also stored in the memory which caused the numbers of failure more than 5. Thus, for some failure modes which are unable to retrieve because of remote controller limit to redisplay only 5 failure modes, it can be found by clearing up the memory first then recheck the memory content again during the visit at the customer place.



### < How to redisplay failure diagnosis >

1. Turn the circuit breaker OFF.
2. Set the remote controller to OFF condition, indicated by **OFF** on the display.
3. By pressing  (MODE) button on the remote controller, set to Cooling operation indicated by  (COOL).
4. Turn the circuit breaker ON.
5. Set the room temperature setting on the remote controller to 32°C by pressing the (TEMP  $\downarrow$  or  $\uparrow$ ) button.
6. Set the fan speed with the  (FAN SPEED) button according to the desired failure information. (Refer to the corresponding table below)

Fan Speed	Data
AUTO 	Newest
HI 	Second newest
MED 	Third newest
LOW 	Fourth newest
SILENT 	Oldest

7. While directing the remote controller towards the receiver of the indoor unit, press (TEMP  $\uparrow$ ) button and  (START/STOP) button simultaneously. (The remote controller perform signal transmission with the device.)
8. The device beeps [Pi-] to indicate that it has just received the signal to redisplay the failure mode.
9. Direct the remote controller towards the receiver of indoor unit (within 2 meters in front of indoor unit) and press the  (INFO) button. Wait for 2 seconds for signal transmission. An error code will be displayed on the remote controller display.

### < How to clear the troubleshooting data >

1. Redisplay the troubleshooting status. (See the above procedure.)
2. Turn the circuit breaker OFF.
3. By pressing  (MODE) button on the remote controller, set to Heating operation indicated by  (HEAT).
4. Turn the circuit breaker ON.
5. Set the room temperature setting on the remote controller to 16°C by pressing the (TEMP  $\downarrow$  or  $\uparrow$ ) button.
6. While directing the remote controller towards the receiver of the indoor unit, press (TEMP  $\downarrow$ ) button and  (START/STOP) button simultaneously. (The remote controller perform signal transmission with the device.)
7. The product beeps for a second [Pi-] to indicate that it has just received the signal. The data has now been cleared.

### < How to display error code in case of failure just occurs >

If timer lamp  of the indoor unit blinking and operation stops, please perform below procedures.

1. Direct the remote controller towards the receiver of indoor unit (within 2m in front of the indoor unit) and press  (INFO) button.
2. Wait for 2 seconds for signal transmission.
3. Indication of error code will be shown on the remote controller display for 10 seconds.

For example :

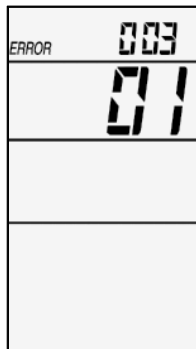
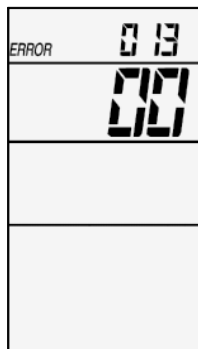

List of error display on the remote control LCD for indoor diagnosis memory function.

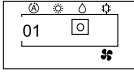
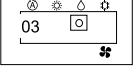
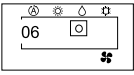
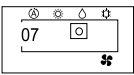
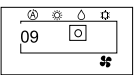
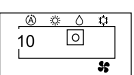
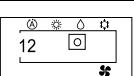
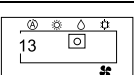
TIMER LAMP BLINKING	WIRELESS REMOTE CONTROL DISPLAY	WIRED REMOTE CONTROL DISPLAY	SELF-DIAGNOSE CONTENT	ERROR DESCRIPTION DETAIL	MAIN CHECK POINT
-	000 00	-	Normal		
1 time	001 00		Refrigerant cycle abnormal.	When the indoor heat exchanger temperature is too low in the heating mode or it is too high in the cooling mode.	1. Reversing valve defect. 2. Heat exchanger thermistor disconnected.(heating mode)
2 times	-	-	Outdoor unit is under forced operation.	It is not a failure. Outdoor unit is in forced operation or balancing operation after forced operation.	1. Outdoor electrical parts.
3 times	003 00		Indoor interface failure.	Interface signal from outdoor unit is interrupted.	1. Indoor interface circuit. 2. Outdoor interface circuit.
6 times	006 00		Abnormal water level detected.	All operation stop when the float switch has been activated.	1. Drain pan blocked. 2. Drain pump. 3. Float switch
7 times	007 00		Drain pump in test operation.	When the knob of drain pump test switch at indoor PWB main was slide to "test" position.	1. Indoor PWB main.
9 times	009 00		Indoor sensor failure.	Room thermistor or heat exchanger thermistor disconnected or short-circuit.	1. Room thermistor. 2. Heat exchanger thermistor.
10 times	010 00		Abnormal rotating numbers of DC fan motor.	Overcurrent is detected at the DC fan motor of the indoor unit.	1. Indoor interface circuit. 2. Outdoor interface circuit. 3. Indoor PWB main.
12 times	012 00		Outdoor interface failure.	Interface signal from indoor unit is interrupted.	1. Outdoor interface circuit. 2. Indoor interface circuit.
13 times	013 00		IC401 data reading error.	Data read from IC401 is incorrect.	1. Indoor PWB main.

[ Cautions ]











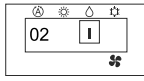
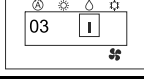

This function is effective only once immediately after the power is turned ON. It will not work if you have performed another remote control operation before hand. Note also that it may not function in response to a procedure other than the above. (If it does not work, turn OFF the power, turn it back ON and repeat the procedure.) If the memory stores nothing, performing a redisplay operation will not blink the timer lamp. For a normal operation, turn OFF the power and turn it back ON. After the above operation, the product will not receive a remote control signal normally. After clearing the troubleshooting data, turn OFF the power. (If you do not turn OFF the power, the product will become unresponsive to remote control signal.)

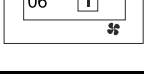
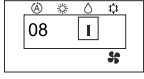
Detail error display for outdoor shall refer to next 2 pages.

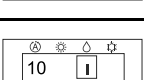

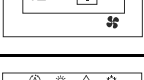
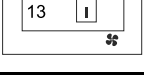
### List of error code when using Self-Diagnosis Memory Function

Please refer to the display screen of wireless or wired remote control.

(This error code only for error happen at outdoor side)

INDOOR OPERATION LAMP BLINKING	WIRELESS REMOTE CONTROL DISPLAY	WIRED REMOTE CONTROL DISPLAY	SELF-DIAGNOSE CONTENT	ERROR DESCRIPTION DETAIL	MAIN CHECK POINT
2 times	002 01		Peak current cut.	Over current is detected.	1. Compressor 2. P.W.B.s
3 times	003 01		Compressor abnormal low speed rotation.	Position detection signal has no input during operation.	1. Compressor 2. P.W.B.s
4 times	004 01		Compressor switching failure.	Fail to switch from initial low frequency sync to position detection sync.	1. Compressor 2. P.W.B.s
5 times	005 01		Overload lower limit cut.	Overload condition still persisting even rotation speed is below the lower rpm limit.	1. Outdoor unit is expose to direct sunlight or its air flow blocked. 2. Fan motor 3. Fan motor circuit 4. The voltage is extremely low
6 times	006 01		OH thermistor temperature rise.	OH thermistor is operating.	1. Leak of refrigerant 2. Compressor 3. OH thermistor circuit 4. Fan motor 5. Fan motor circuit
8 times	008 01		Communication error between microcomputer.	Communication between inverter microcomputer and main microcomputer failed.	1. Connector insertion at CN21 & CN22 2. P.W.B.s
9 times	009 01		Indoor type mismatch.	Single model connected.	1. Main P.W.B. 2. Indoor unit
10 times	010 01		Abnormal power source.	Power supply voltage is incorrect.	1. Power supply voltage 2. P.W.B.s
12 times	012 00		Fan motor faulty.	Outdoor fan rpm is not rotate as intended rpm.	1. Fan motor 2. Fan motor circuit
13 times	013 01		EEPROM reading error.	Microcomputer cannot read the data in EEPROM.	1. P.W.B.s
14 times	014 01		Active converter defect.	Over voltage is detected or compressor load is abnormal.	1. P.W.B.s 2. Compressor
7 times	071 01		Oveheat Thermistor	Thermistor's connector not connected or thermistor's wire worn out or shorted.	1. Thermistor 2. Connection of thermistor faulty 3. Thermistor circuit
7 times	072 01		Defrost Thermistor		
7 times	073 01		Outdoor Temperature Thermistor		
7 times	074 01		Narrow pipe thermistor abnormal (Indoor no.1)		
7 times	075 01		Wide pipe thermistor abnormal (Indoor no.1)		

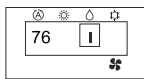
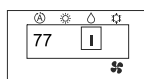
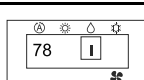
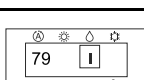
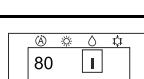
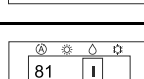

7 times	076 01		Narrow pipe thermistor abnormal (Indoor no.2)	Thermistor's connector not connected or thermistor's wire worn out or shorted.	1. Thermistor 2. Connection of thermistor faulty 3. Thermistor circuit
7 times	077 01		Wide pipe thermistor abnormal (Indoor no.2)		
7 times	078 01		Narrow pipe thermistor abnormal (Indoor no.3)		
7 times	079 01		Wide pipe thermistor abnormal (Indoor no.3)		
7 times	080 01		Narrow pipe thermistor abnormal (Indoor no.4)		
7 times	081 01		Wide pipe thermistor abnormal (Indoor no.4)		
7 times	082 01		Narrow pipe thermistor abnormal (Indoor no.5)		
7 times	083 01		Wide pipe thermistor abnormal (Indoor no.5)		

# Diagnosing Indoor unit, Outdoor unit and Refrigerant cycle.

Initiating troubleshooting

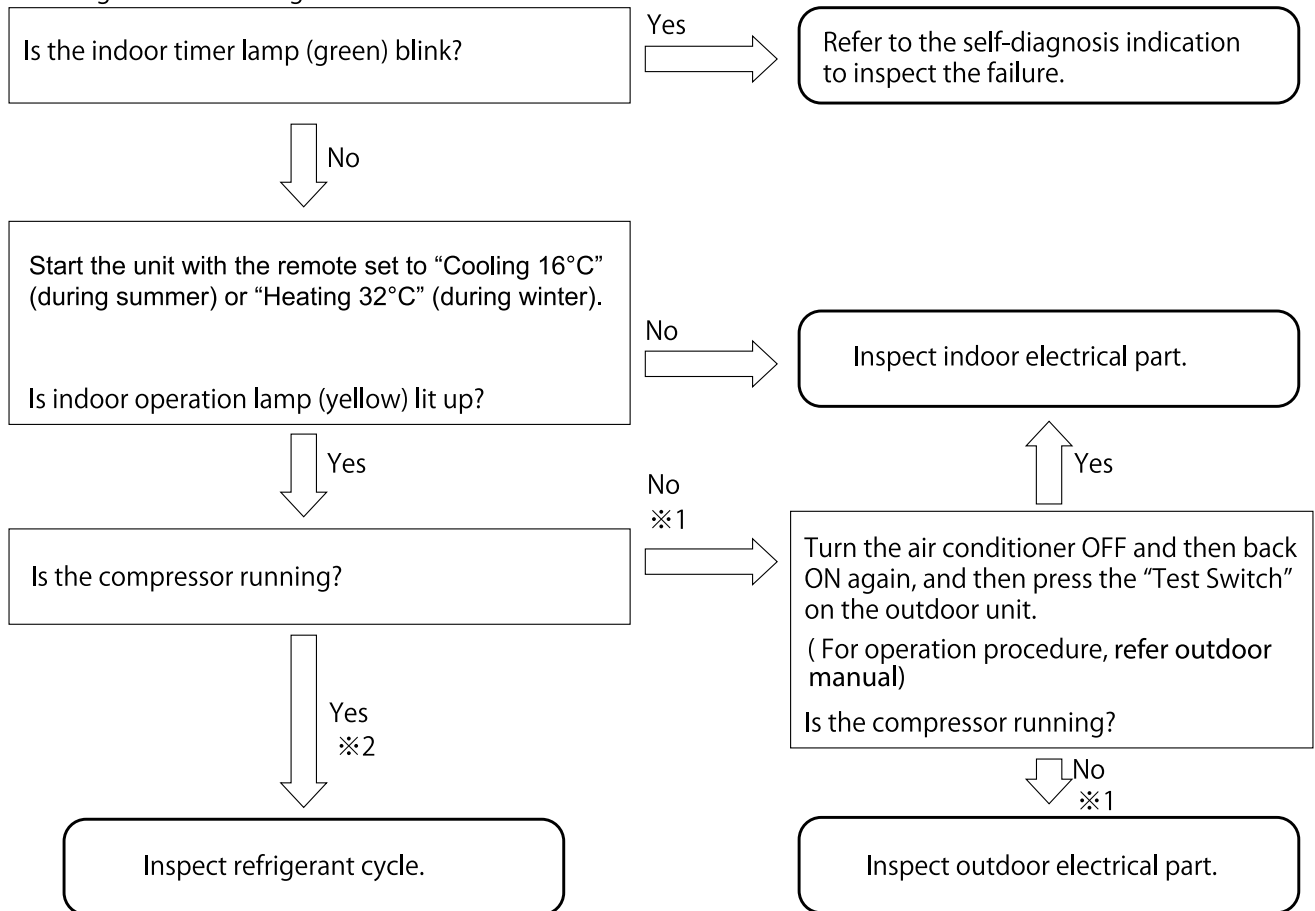

<Failure Diagnosis Using the Self-Diagnosis Memory Function> (Refer page for detail)

- You can use the self-diagnosis memory function to check the failure mode (※1) that occurred on the outdoor unit from the indoor unit.

- Step
1. Clear the troubleshooting data.
  2. Run the unit for several minutes under condition where the compressor runs.
  3. Redisplay and check the data written in the self-diagnosis memory.

- The self-diagnosis memory function can also be used to catch sporadic failure phenomena.

- Step
1. Clear the troubleshooting data.
  2. Have the user use the product as usual until a failure phenomenon occurs. (The period depends on the incidence of the phenomenon)
  3. At a later date, redisplay and check the data written in the self-diagnosis memory.

- Outdoor self-diagnosis indicator (rising compressor temperature, overload lower limit cut) that are caused by the cooling cycle or the usage environment take a long time to occur after the unit starts running. Further, they are influenced by atmospheric temperature, direct sunlight and operation time, all of which can make it difficult to confirm the failure when a repairman visit. In such case, use the self-diagnosis memory function. (※2)
- The "Fan stopped due to strong wind", "Compressor temperature rise" and "Power voltage error" self-diagnosis indicators on the outdoor unit can be confirmed only by checking the self-diagnosis lamp on the outdoor unit or using the self-diagnosis memory function on the indoor unit.

# Checking the indoor unit electrical parts

## Introduction

First, check the failure and conditions before moving to a detail diagnosis.

### Initiating troubleshooting

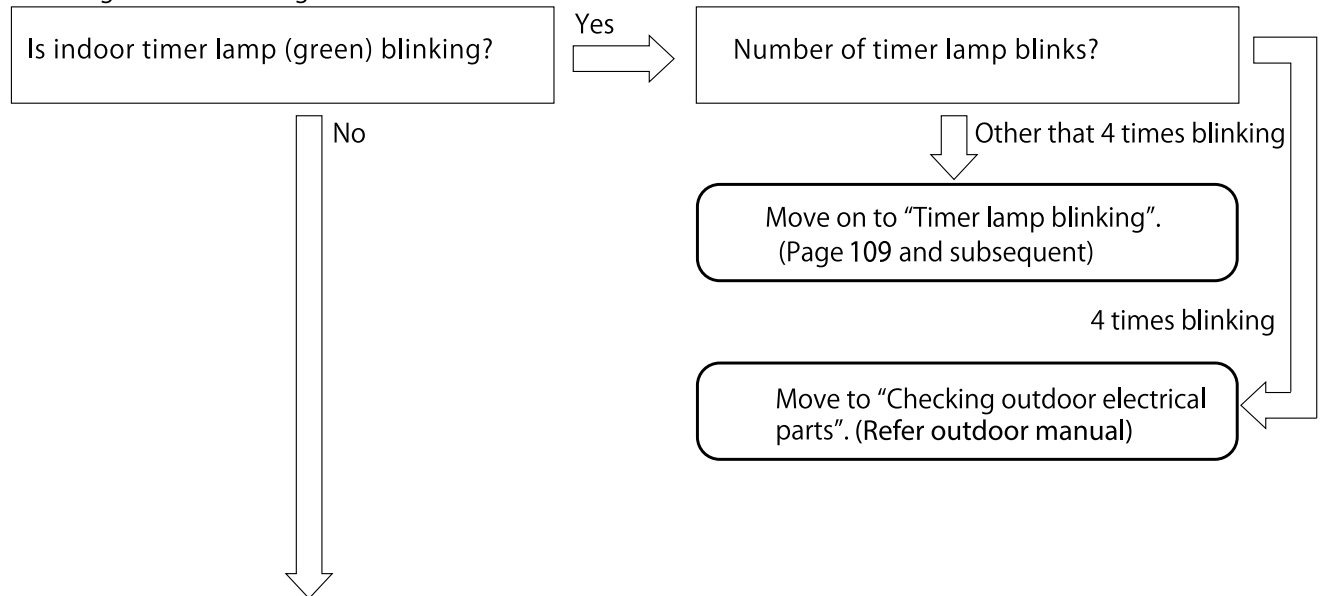

Turn the air conditioner's breaker OFF, wait at least 5 seconds and then turn it ON again. Observe the movement of the horizontal deflector for about 30 seconds.

Check 1 : Does the horizontal deflector move? (Yes / No)



Set the remote control unit to cooling mode, temperature setting 16°C (summer), heating mode, temperature setting 32°C (winter) and operate the product.

Check 2: Can the product received the remote control signal and has the "operation lamp" lit up? (Yes/No)

If you responded "Yes" to Check 2:

Check 3: Is the compressor of the outdoor unit running? (Yes/No)

If you responded "No" to Check 2:

Check 4: Does the indoor "emergency switch" work? (Yes/No)

### Check results and next check items

Check 1	Check 2	Check 3	Check 4	Next check item
No	No	—	No	Go on to "Power does not come on". (page 102)
Yes	No	—	Yes	Go on to "The product will not receive the remote control signal". (page 104)
Yes	Yes	No	—	Go on to "The compressor not run". (page 107)

# 1. Failure : Power does not come on

[ Situation ] Initialization of the horizontal deflector position and remote control reception do not occur when the power turned ON.

- [ Suspected failure location ]
- Power supply
  - Indoor fan motor
  - Switching power circuit

- [ Cautions ]
- When going on a service run to address a "Power does not come on" failure, bring along a "3.15A fuse (FU1)" and a "varistor (VA03)."
  - Before start repair work, check the voltage coming to the air conditioner's breaker. On rare condition, an abnormal voltage might be supplied by faulty house wiring (240V applied to 100V outlet, neutral line disconnected in single phase 3-wire power supply).
  - If an abnormal high voltage is applied to the unit, the 3.15A fuse and the varistor are degraded or damaged, and should be replace.
  - If the 3.15A fuse is blown, the cause must be remove first or else the new fuse will blown as well.
  - The indoor fan motor is connected to the primary power source. Therefore, a voltage to ground occurs. Take care to avoid electric shock.
  - The indoor fan motor uses the same fuse as the control board. If the 3.15A fuse is blown, check the indoor fan motor before turning the power ON.

## [ Diagnosis flow ]

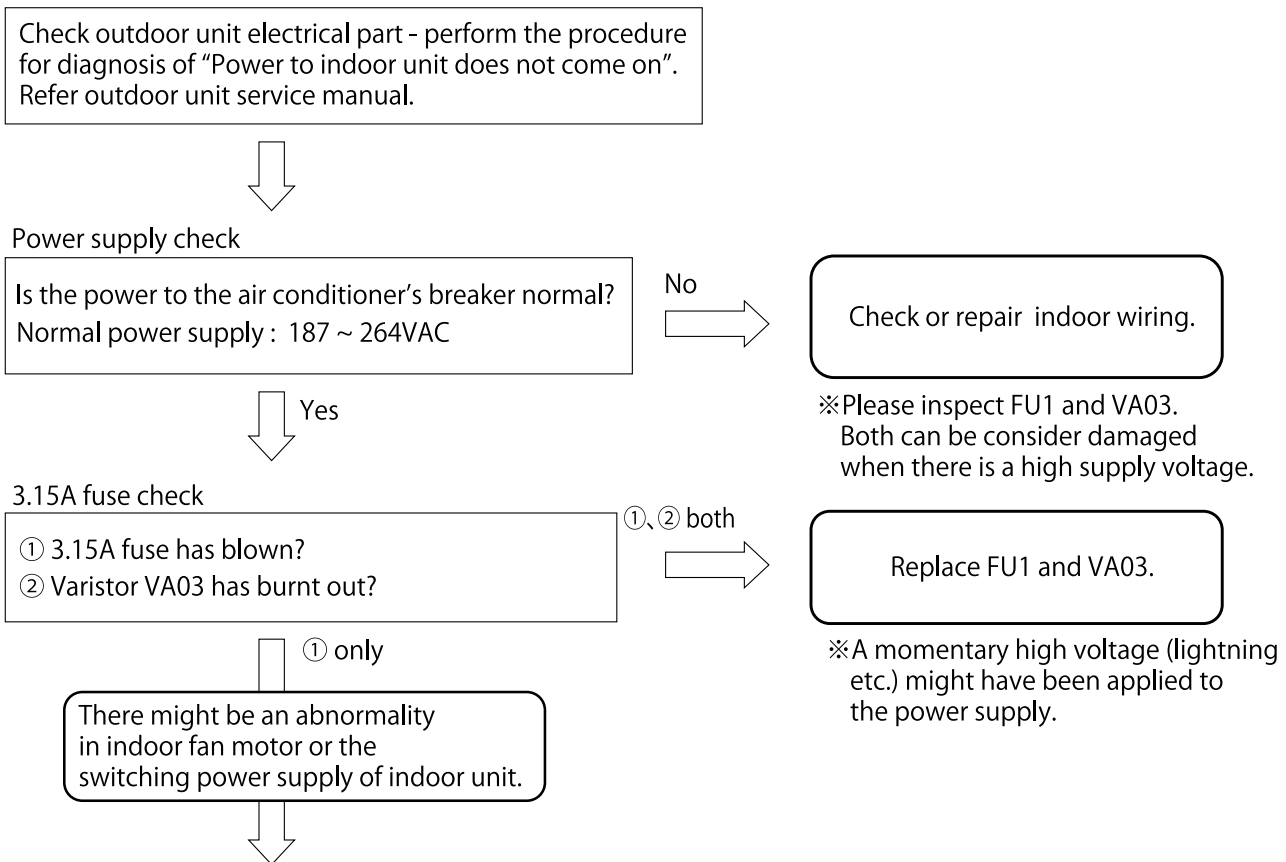

### Check indoor fan motor

Turn the fan blade a few times by hand.

Is the spindle tight?

※If the short-circuit occurs, the fan become tight and difficult to turn.

Is there a short-circuit between red and black wire?

※Use a tester to check the insulation between red and black wire of connector CN12 on the indoor PWB.

Yes



Replace indoor fan motor and 3.15A fuse.

No

There might be an abnormality in switching power supply of indoor unit.



### Check indoor electrical

Replace the 3.15A fuse.

At this time be sure to disconnect the connector CN12 on the indoor PWB side.

Again turn ON power supply, has the 3.15A fuse blown?

※For safety, be sure to close the cover on the indoor unit before performing this work. If you hear any noise, immediately turn the air conditioner's breaker OFF.

No



Check all output voltage to search again for problems with the switching power supply. (0V,5V,8.5V,12V)

Check for other abnormalities in the PWB and remove any abnormalities that are found.

Yes



Replace indoor PWB.

## 2. Failure : Remote control does not receive communication signal

[ Situation ] No reception or poor reception by the remote control.  
(Unit operate normally when using temporary switch)

[ Suspected failure location ]

- The remote control is damaged, has dead batteries or cannot be reset.
- Remote control receiving unit.
- The connector is loose or disconnected.
- The product is normal (external cause : lighting, remote control of other device, electrical noise, etc.)

[ Cautions ]

- Even if there are no abnormalities in the product, external factor to the product can cause interference with remote control reception.
- The capacity of the batteries drops in low temperature environment. The voltage of old batteries will drops in particular in the morning and at night in the winter, possibly resulting in reduced remote control range. So, please use new alkaline batteries.

[ Diagnosis flow ]

### Initiating troubleshooting

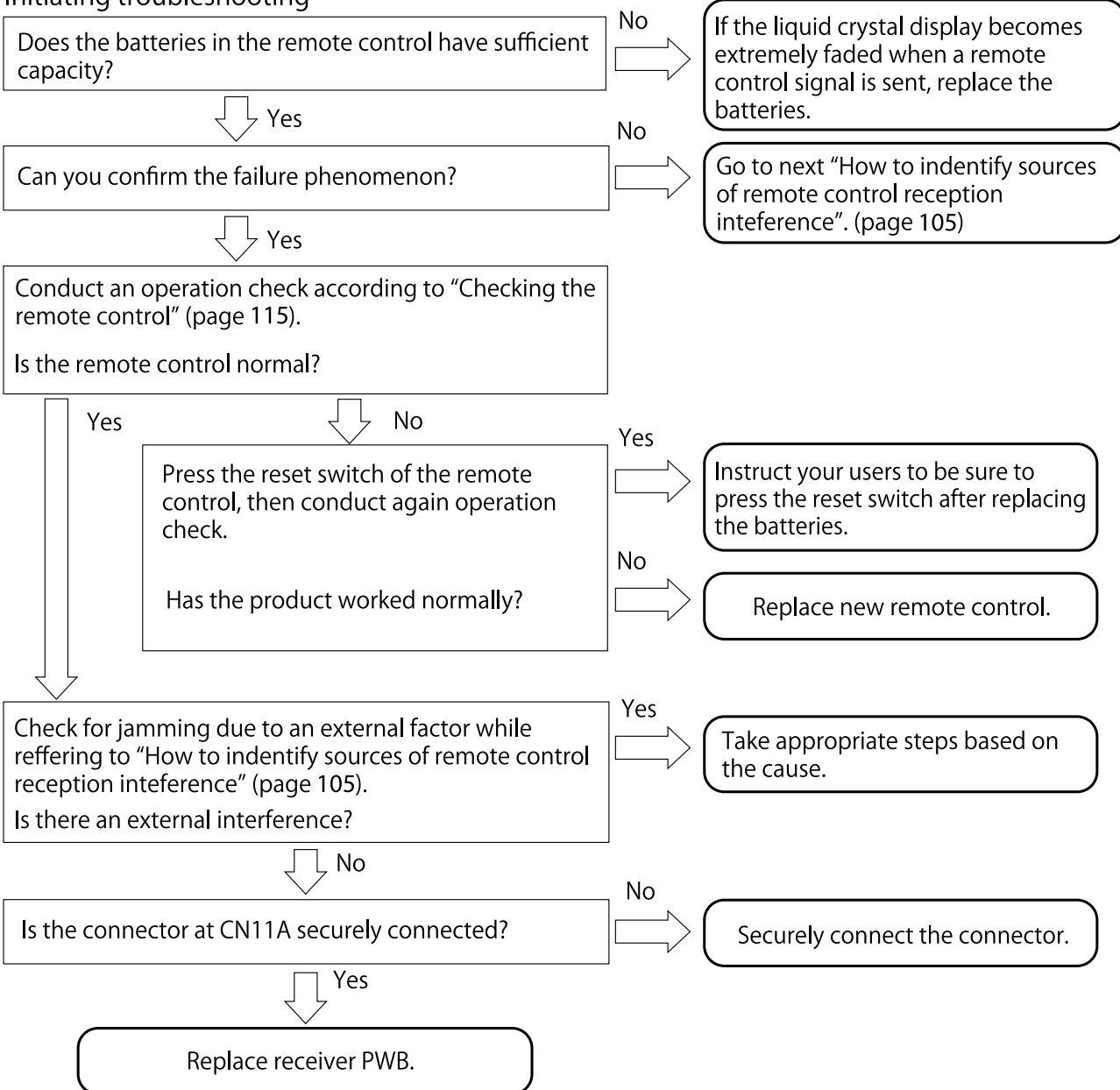

## How to identify sources of remote control reception interference

[ Situation ] The product may become poorly responsive to remote control signals due to external factors even though the product itself is trouble-free.

[ Suspected sources of interference ] Identify the installation status of the air-conditioner and the indoor and outdoor environments to identify possible causes of the interference.

- Indoor lighting equipment (quantity, type, location)
- Remote control units of other electrical products and equipment
- Is the grounding for the air-conditioner shared with other equipment?
- Are the surroundings of the air-conditioner clear of wireless antenna?
- Is the remote control light-receiving unit protected from direct sunlight?

[ Checking and actions ]

<p>Effects of lighting equipment (fluorescent lamps)</p>	<p><u>Checking points</u></p> <ul style="list-style-type: none"> <li>• Turn on and off the lighting equipment and check for its effects on the reception of remote control signals.</li> <li>• When cold, the fluorescent lamp tends to emit infrared rays with wavelengths close to those used in remote control. If you cannot detect the phenomenon about which your user is complaining at the time of your visit, such as "the product sometimes fails to receive remote control signals" and "the product fails to receive remote control signals in the morning alone", then turn off the lighting for about 20-30 minutes and wait for the fluorescent lamps to cool down before conducting another check. There are even cases where the product fails to receive remote control signals for 1 to 2 minutes only after the lighting equipment is turned on.</li> <li>• The noise status may vary with the dimming of the lighting equipment. In the case of lighting equipment with a dimmer, therefore, conduct a check with all the light intensities.</li> <li>• If the lighting equipment is the source of the jamming, the remote control light-receiving unit output usually shows a noise waveform as shown in the right-hand figure. In the case of slight jamming, this kind of waveform will not cause practical problems. However, intense degrees of jamming will disable the reception of remote control signals.</li> <li>• When the fluorescent lamp is old and is flickering, it may cause disorders in the reception of remote control signals.</li> </ul> <p><u>Actions proposed</u></p> <ol style="list-style-type: none"> <li>1. Make it hard for light of the lighting equipment to enter the remote control light-receiving unit. <ul style="list-style-type: none"> <li>• Separate the lighting equipment from the indoor unit.</li> <li>• Raise the lighting equipment.</li> <li>• Cover the upper half of the light-receiving panel from its rear side with aluminum tape or black vinyl tape.</li> </ul> <p>( This will also affect the reception of remote control signals. Therefore, set the range to be covered with tape to a range that is problem-free in practice, while checking the reception status. )</p> </li> <li>2. Add an interference filter to the front panel of the remote control light-receiving unit. <ul style="list-style-type: none"> <li>※ Lighting equipment that produces strong interference exists although rarely.</li> <li>Some problems may therefore be unsolvable by managing the air-conditioner side alone.</li> </ul> </li> </ol>
<p>Effects of the remote control units of other equipment</p>	<p><u>Checking points</u></p> <ul style="list-style-type: none"> <li>• If, on the remote control unit of a TV or audio equipment, its sound volume key or something similar is left pressed, infrared signals become continuously sent, thereby jamming the reception of remote control signals.</li> <li>• Check how the remote control unit and related components are stored, thereby checking if there is any possibility that a button may be inadvertently left pressed on the remote control unit of other equipment.</li> </ul> <p><u>Actions proposed</u></p> <p>If there is any such possibility, give explanations to your users to that effect and instruct them to exercise caution.</p>

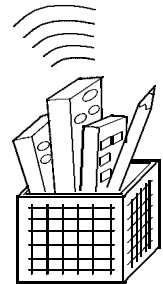
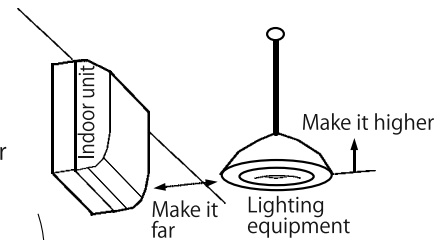
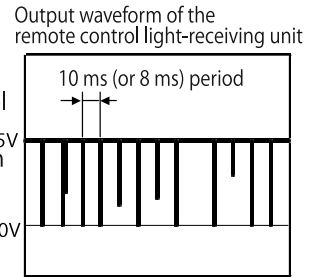

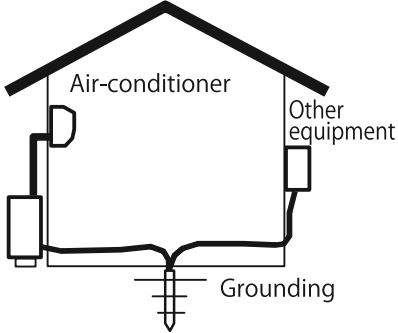
Effects of other electrical products	<p><u>Checking points</u></p> <ul style="list-style-type: none"> <li>• Check the effects of light and power noises coming from other electrical products.</li> <li>• Turn on and off the electrical products, turn off the power and turn on the power, and check their effects on the reception of remote control signals.</li> <li>• For products whose operating states change, check the effects of each state.</li> </ul> <p><u>Actions proposed</u></p> <ul style="list-style-type: none"> <li>• Change the location relationship between the air-conditioner and the target products.</li> <li>• Use a different wall outlet for the target products.</li> </ul>
Sharing a grounding	<p><u>Checking points</u></p> <ul style="list-style-type: none"> <li>• Check for effects of electrical noises coming into the air-conditioner through grounding wires.</li> <li>• Check if the grounding works is for the air-conditioner alone or shared with other equipment. If there is any equipment that shares it, turn on and off that equipment and detach and reattach the power plugs and examine their effects on the reception of remote control signals.</li> </ul> <p><u>Actions proposed</u></p> <ul style="list-style-type: none"> <li>• Establish an independent grounding for the air-conditioner.</li> </ul> 
Effects of radio waves	<p><u>Checking points</u></p> <ul style="list-style-type: none"> <li>• Using a wireless transmitter near the air-conditioner may affect the reception of remote control signals.</li> <li>• Have your users try sending signals with a wireless transmitter and examine their effects on the reception of remote control signals.</li> </ul> <p><u>Actions proposed</u></p> <ul style="list-style-type: none"> <li>• Add a ferrite core to the power cord and F cable.</li> <li>• Add a ferrite core to the internal wiring of the indoor unit.</li> <li>• Move the wireless antenna.</li> </ul>
Effects of direct sunlight	<p><u>Checking points</u></p> <ul style="list-style-type: none"> <li>• Direct sunlight and other intense light make the remote control light-receiving unit less sensitive.</li> <li>• Check for any time zone where the remote control light-receiving unit of the indoor unit is affected by direct sunlight depending on the location of the sun and mirror reflection.</li> </ul> <p><u>Actions proposed</u></p> <ul style="list-style-type: none"> <li>• Block the sunlight to protect against direct sunlight.</li> </ul>



### 3. Failure : Compressor does not run

[ Situation ] Compressor does not run (same condition as thermo off), remote control reception is normal.  
The self-diagnosis lamp on the outdoor unit (LD351) blinks once or is off.

[ Suspected failure location ]

- Indoor room thermistor, Heat exchanger thermistor
- Micro computer surrounding circuit

[ Diagnosis flow ]

Initiating troubleshooting

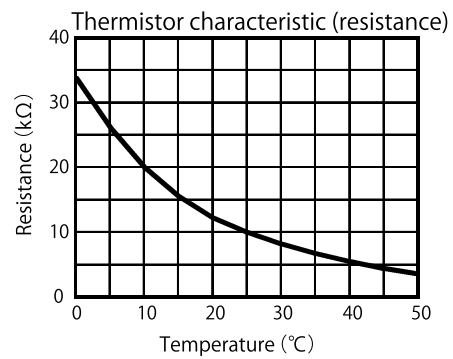
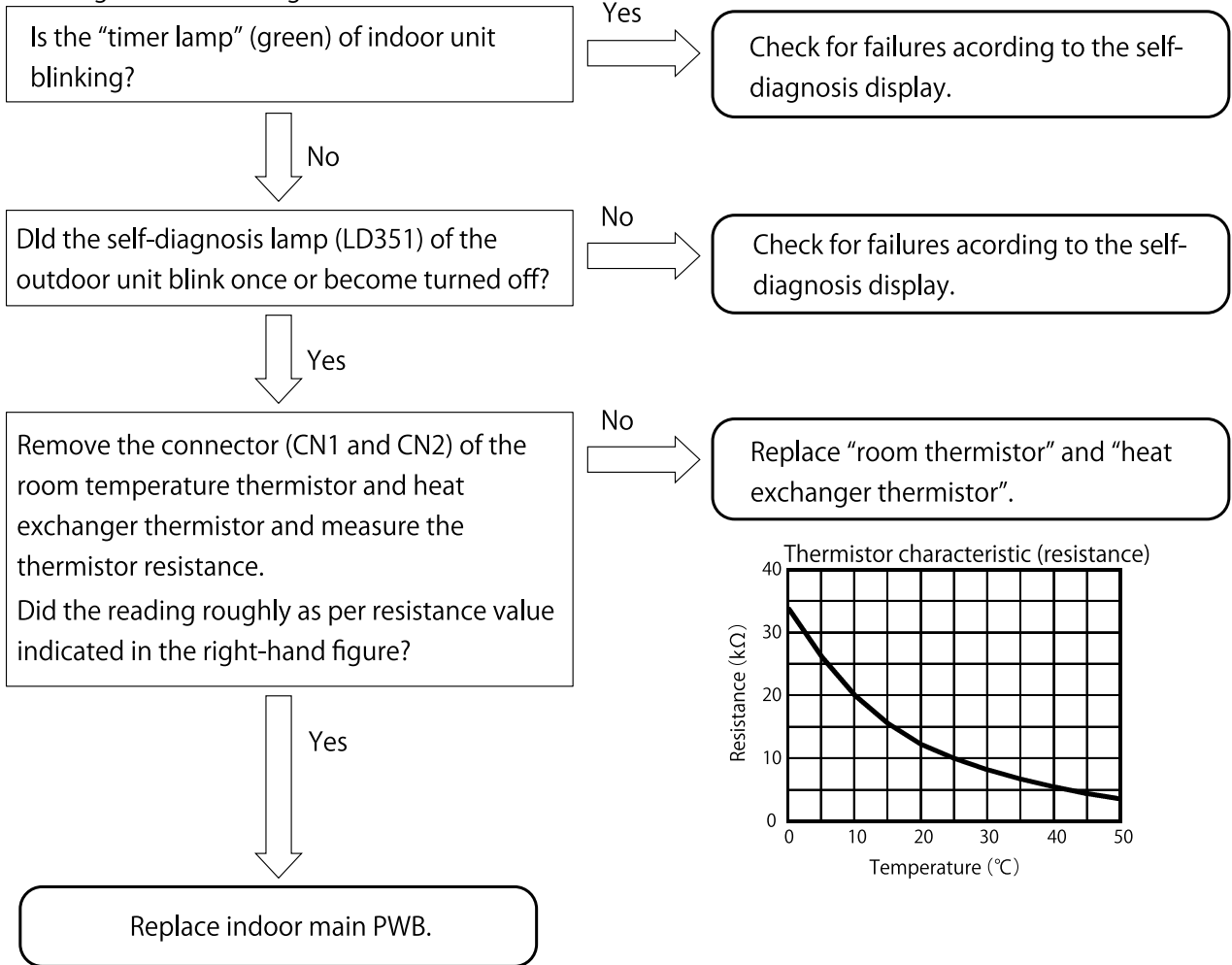

#### 4. Failure : The fan motor does not stop

[ Situation ]                      Operation stops with the remote control, but the indoor fan motor does not stop.

[ Suspected  
failure location ]                      ● Indoor fan motor  
   ● Fan motor driven circuit

[ Diagnosis flow ]

Initiating troubleshooting

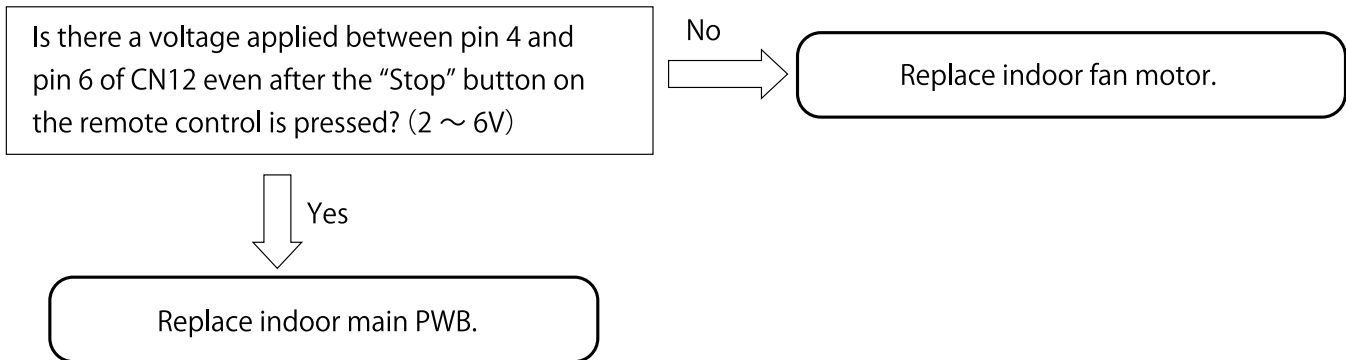

※ When voltage is applied to pin 6 (motor speed command) the indoor fan motor runs. Normally, signals (PWM) from the microcomputer pass through the photocoupler and apply voltage to pin 6. At this time, DUTY is variable according to speed and the speed is adjusted or stopped. However, if there is a short-circuit in the photocoupler, the voltage remains applied continuously and the fan motor cannot stop as long as Vcc is ON.

#### 【Behaviour of the motor when a failure occurs】

- Power supply ON.
- Horizontal deflector start initialization movement.
- Same time the fan motor start rotating.
- Send an operation command with the remote control.
- Send the stop command with the remote control.
- Normally operation should stop, but the indoor fan motor continues to run.

## 5. Timer lamp blinking : 1 time

[ Situation ]                      Timer lamp blinks once and unit operation is not possible.

- [ Suspected failure location ]
- Control circuit failure in outdoor reversing valve, connector disconnected
  - Mechanical locking of reversing valve, broken coil wire
  - Incorrectly installed indoor unit heat exchanger thermistor (during heating only)
  - Clogged cycle (forgot to open service valve, etc.)
  - Refrigerant leak

( If most refrigerant is removed in extremely hot (40°C or greater room temperature) or extremely cold (5°C or lower room temperature) conditions, it is possible for this failure mode to occur. (Absolutely no cooling or heating) )

[ Diagnosis flow ]

Refer to page "Inspection when timer lamp on indoor unit blink once" of outdoor unit service manual.

## 6. Timer lamp blinking : 2 times

[ Situation ]                      The unit is under forced cooling operation (Not a malfunction).

## 7. Timer lamp blinking : 3 times

[ Situation ]                      Timer lamp blinks 3 times and unit operation is not possible.

- [ Suspected failure location ]
- Indoor communication circuit failure

[ Diagnosis flow ]

Refer main circuit operation for "Indoor/ outdoor communication circuit (page 85)





# 11. Timer lamp blinking : 10 times

[ Situation ]                      Timer lamp blinks 10 times and unit operation is not possible.

- [ Suspected failure location ]
- Fan motor connector disconnected or lead wire worn out
  - Mechanical locking of indoor fan motor or the T-fan.
  - Indoor fan motor failure
  - Indoor fan motor driver circuit failure

[ Diagnosis flow ]

Make sure to turn OFF the circuit breaker.



T-fan check

Can the fan rotate lightly?  
 ※Check or rotate by inertia  
 ※Confirm there is no abnormal sound fan is rotating.

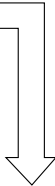
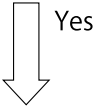

Check work step

Is the fan motor connector (CN12) connection securely?  
 Is there any short-circuit?

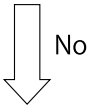
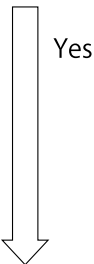

Securely connect.

Are there any factors that interfere with the mechanical rotation?  
 Ex.) Foreign matter is mixed in the t-fan.  
 Ex.) Adhesion of dust is accumulated.

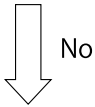
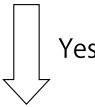

Remove blocking cause.

Replace fan motor.

※Bearing and axis abnormal

Fan motor check

Turn the breaker ON and make the indoor fan motor start to rotate (cooling mode operation or etc.)  
 ※Power supply of indoor fan motor is connected to the primary power supply, therefore it is voltage to ground has occurred. Please be careful of electric shock.

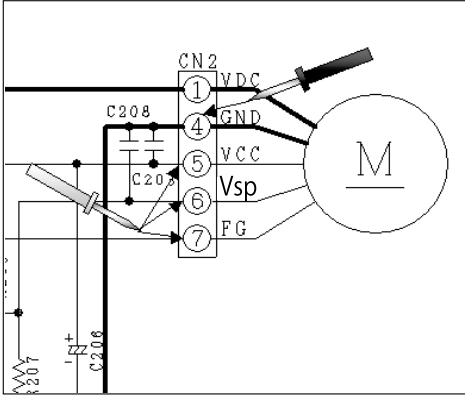

【Inspection location】

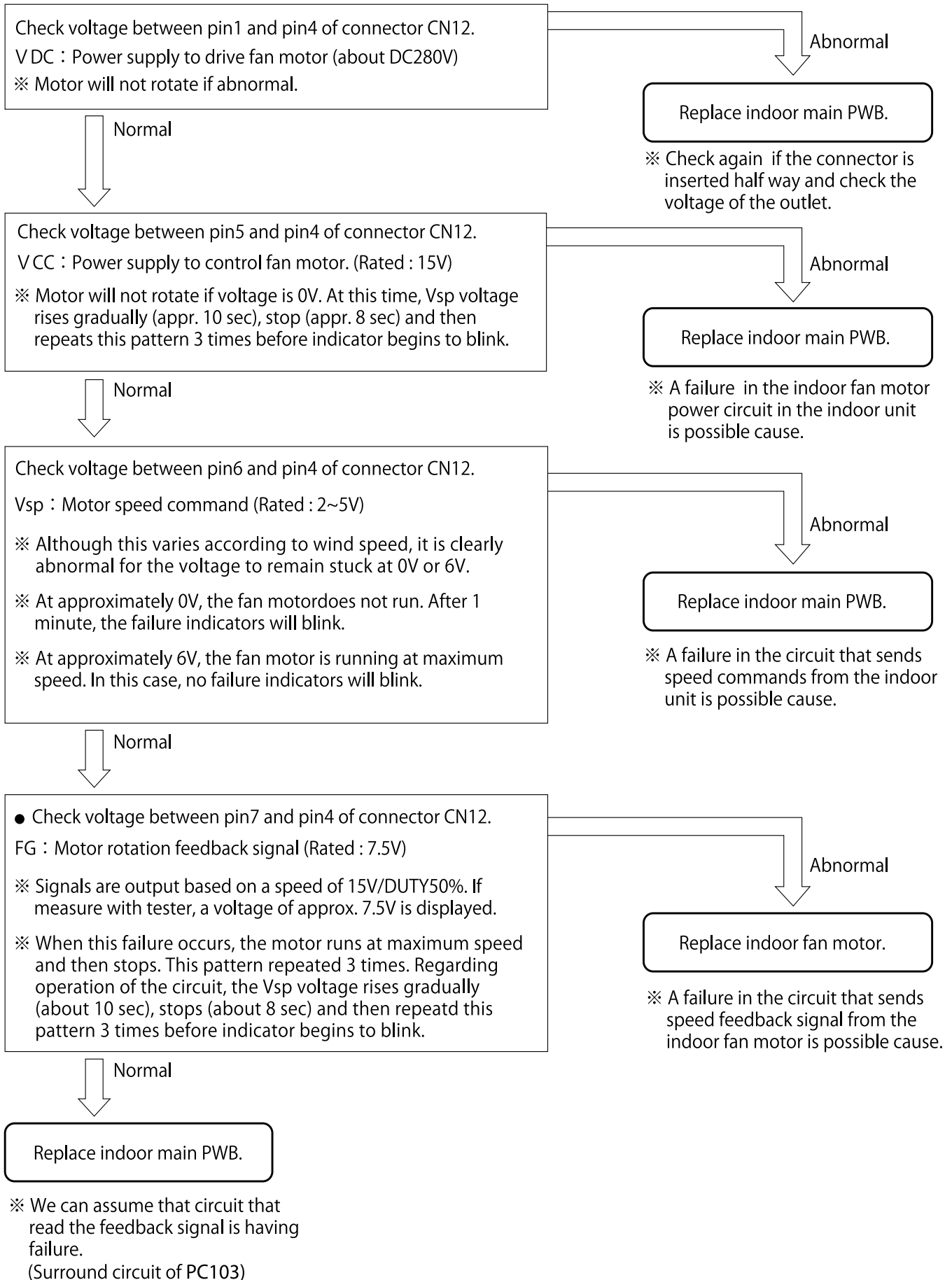

## 12. Timer lamp blinking : 12 times

[ Situation ]                      Timer lamp blinks 12 times and unit operation is not possible.

[ Suspected failure location ]                      ● Connecting cable has an error connection  
● Connecting cable has a short circuit or damage  
● Outdoor unit electrical parts

[ Cautions ]                      ● Communication error due to noise of other electrical appliance  
● If the no.1 line and no.2 line of connecting cable are connected incorrectly (crossed), the self diagnosis might not be indicated. If the "12 times lamp blinks" data is saved in the self-diagnosis memory, double check if the connecting cable is connected correctly.

[ Diagnosis flow ]

Initiating troubleshooting

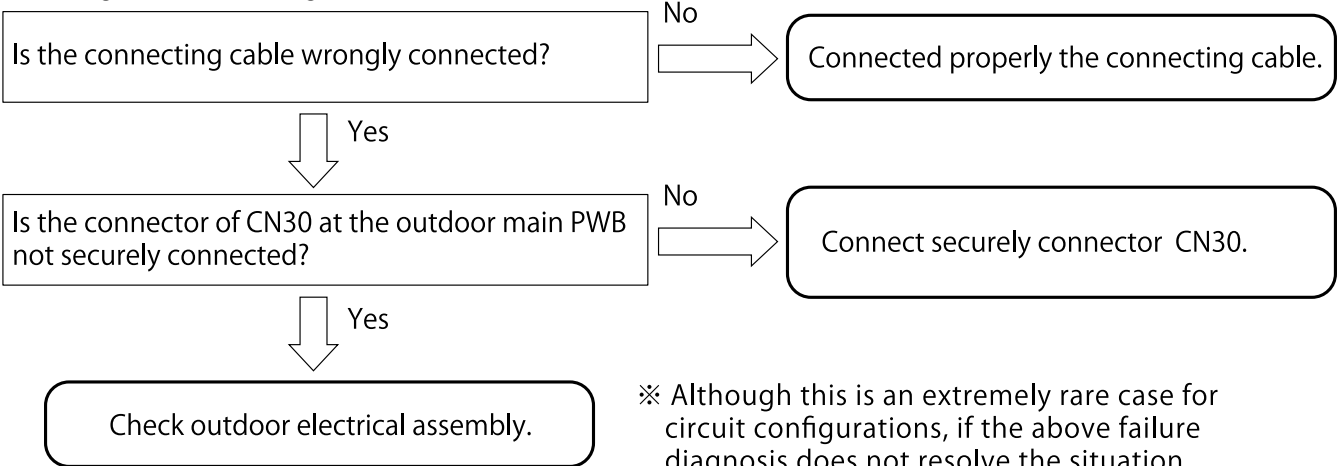

※ Although this is an extremely rare case for circuit configurations, if the above failure diagnosis does not resolve the situation you will need to replace the indoor main PWB.

## 13. Timer lamp blinking : 13 times

[ Situation ]                      Timer lamp blinks 13 times and unit operation is not possible.

[ Suspected failure location ]                      ● EEPROM Ic and Microcomputer Ic

[ Diagnosis flow ]

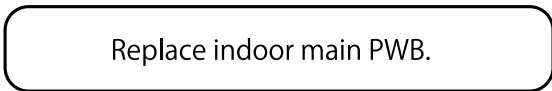



# Inspecting the wireless remote control

## 1. Remote transmission check

The remote control for conforming operation of the remote control is describe in RAR-6N5. The method is the same as for checking other remote control.



send mark

If the send mark does not appear, check the direction of the poles of the batteries (⊕, ⊖) and if the batteries are dead.

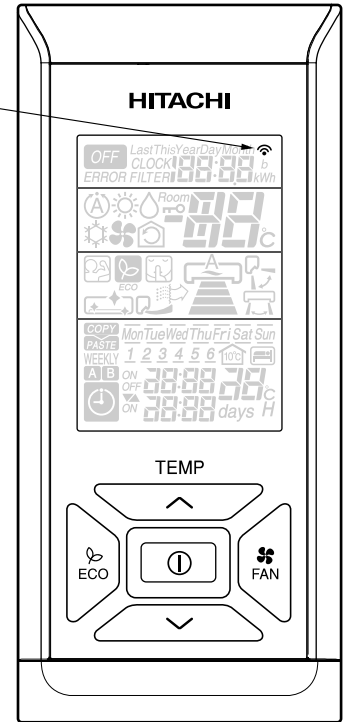

### Method of checking remote control

#### [Checking using PRD checker]

① Select the switch of PRD checker to "Remote checker" side.

② Standing about 3m to 7m away from the PRD checker, aim the remote control toward the sensor and press OFF/START button.

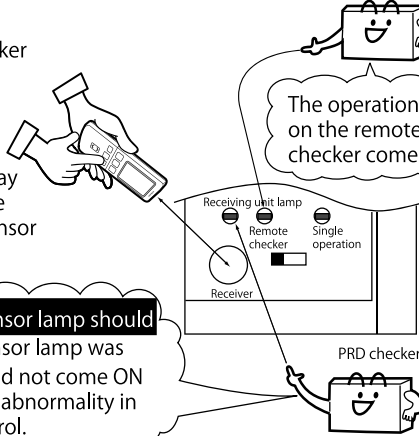

Normally the sensor lamp should lit ON. If the sensor lamp was already ON or did not come ON at all, there is an abnormality in the remote control.

#### [Checking using mobile phone's camera]

※ Some cameras do not clearly show infrared energy.

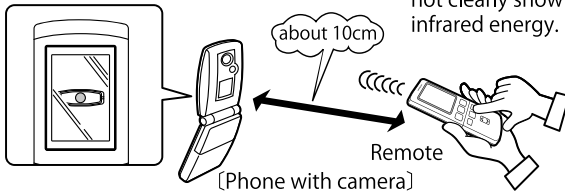

① Hold the mobile phone so that the transmission area of the remote control can be viewed with the camera.  
② On the camera screen, a flash should appear in the transmission area of the remote control when buttons are pressed.

#### [Checking using digital camera]

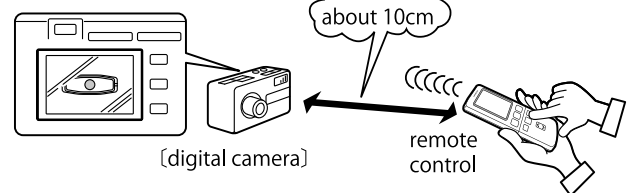

① Hold the camera so that the transmission area of the remote control can be viewed with the camera.  
② On the camera screen, a flash should appear in the transmission area of the remote control when buttons are pressed.

#### [Checking using AM Radio]

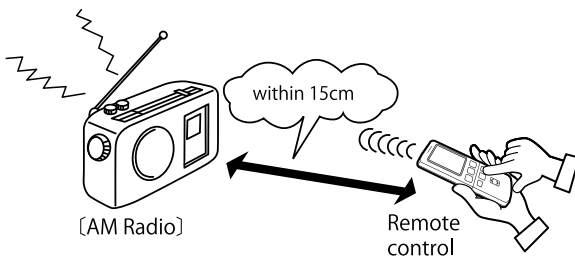

It is normal when noise (bii-bii- sound) should be heard when buttons on the remote control are pressed.

#### [Checking using remote checker card]

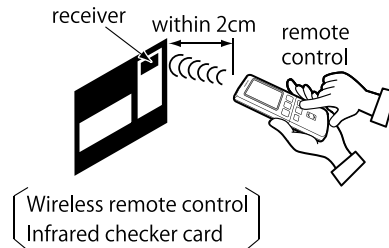

Its consider normal if the receiver turned to orange color when any button was press on the remote control.

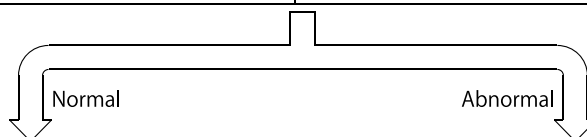

Check for the external causes of interference to the indoor unit and remote control reception.

Check the operation once again. If the remote control does not operate normally, replace it.

Part description	Part no.
PRD Checker	RSC-PRD1006

# HOW TO CHANGE THE SHIFT VALUE SETTING TEMPERATURE USING WIRELESS REMOTE CONTROLLER

The shift value setting temperature for Cooling and Heating mode operation can be change using remote controller. (This procedure shall be implemented strictly by service personnel only.)

(For initial shift value temperature setting for Cooling mode (SHIFTC) and Heating operation mode (SHIFTW) : Please refer to page 69)

## PROCEDURES

1. While pressing and holding (START/STOP) button and (ON) button, press [RESET] button on the same. Release [RESET] button only and make sure that all marks on the remote controller display are indicated, then release the (START/STOP) button and [ON] button. Remote controller now enters "Shift Value Change Mode".

2. Press the (MODE) selector button so that the display indicates (FAN) mode.

3. Press the (START/STOP) button and FAN operation will be started.

4. Set the FAN SPEED with the (FAN SPEED) button according to the following FAN speed setting in order to choose the desired operation mode that is required for shift value setting temperature modification.

- To change the shift value for COOLING mode operation, select either (HIGH) or (MED) FAN SPEED.
- To change the shift value for HEATING mode operation, select either (LOW) or (SILENT) FAN SPEED.

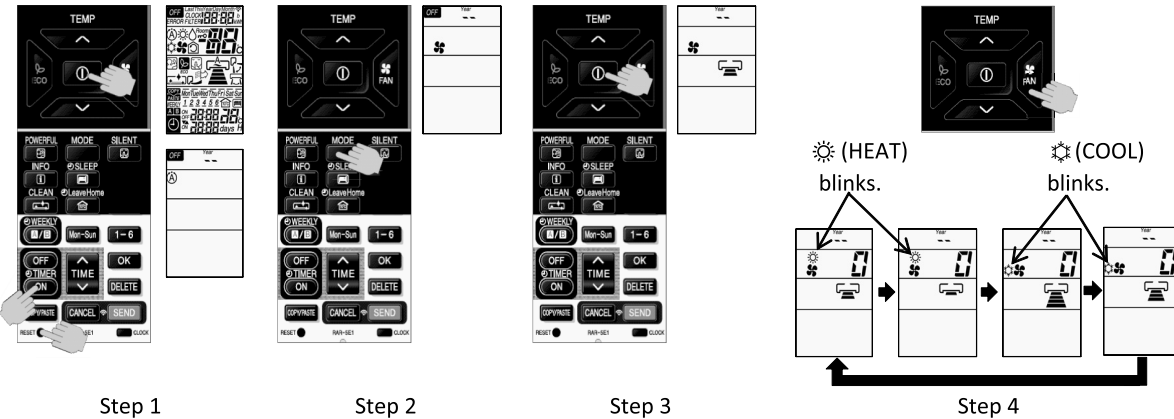

5. Press the (TEMP  $\vee$  or  $\wedge$ ) button to change the shift value. (The shift value changed with device beep sound.)

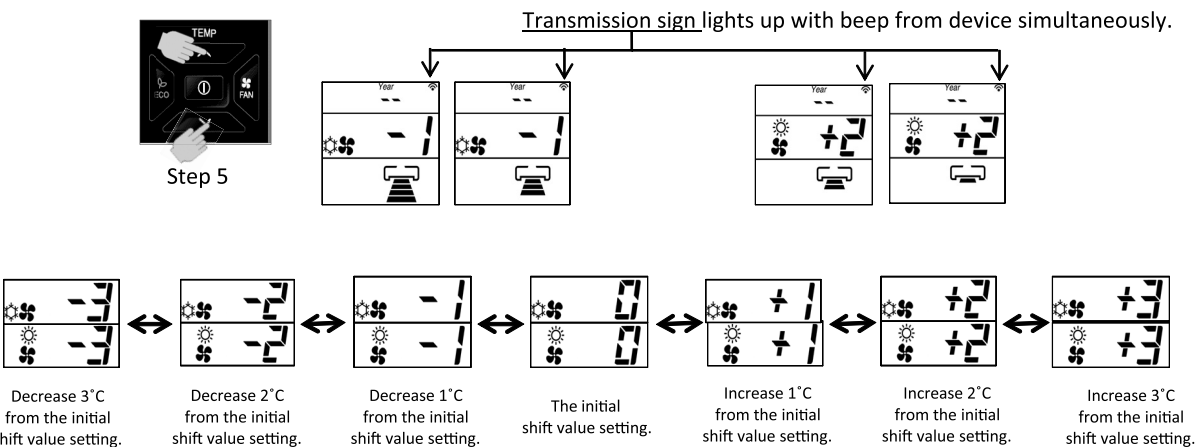

## NOTE :

- (1) The displayed shift value, (HEAT) and (COOL) symbol on the remote controller display will be disappear after 10 seconds.
- (2) The changed shift value will remain unchanged after turned off the power.
- (3) If "0" is displayed on the remote controller display, it indicates the shift value is now at the initial setting.

# HOW TO CHANGE THE SHIFT VALUE for SETTING TEMPERATURE USING WIRED REMOTE CONTROLLER

Shift value for COOLING and HEATING mode operation can be changed using wired remote controller.  
(This procedure shall be strictly carried out by service personnel).

(For initial shift value temperature setting for Cooling mode (SHIFTC) and Heating operation mode (SHIFTW):  
Please refer to page 69)

## PROCEDURE

1. While pressing the **ON/OFF** and **ON TIMER** button, press and release the **RESET** button once.  
All icon will be displayed on the LCD screen and shortly disappear.  
Initial cursor will be at AUTO mode. After about 5 sec, cursor will shift and blink continuously at HEATING mode. Release hold of **ON/OFF** and **ON TIMER** button.  
The remote is now in **SHIFT VALUE CHANGE MODE**.

2. Press **ON/OFF** button. Operation LED will ON. Cursor will stop blinking. Unit will operate in FAN mode.

3. Set the FAN SPEED with the **FAN SPEED** button according to the following FAN speed setting in order to choose the desired operation mode that is required for shift value setting temperature modification.

- To change the shift value of COOLING mode operation, select either **HIGH** or **MED** FAN SPEED.
- To change the shift value of HEATING mode operation, select either **LOW** or **SILENT** FAN SPEED.

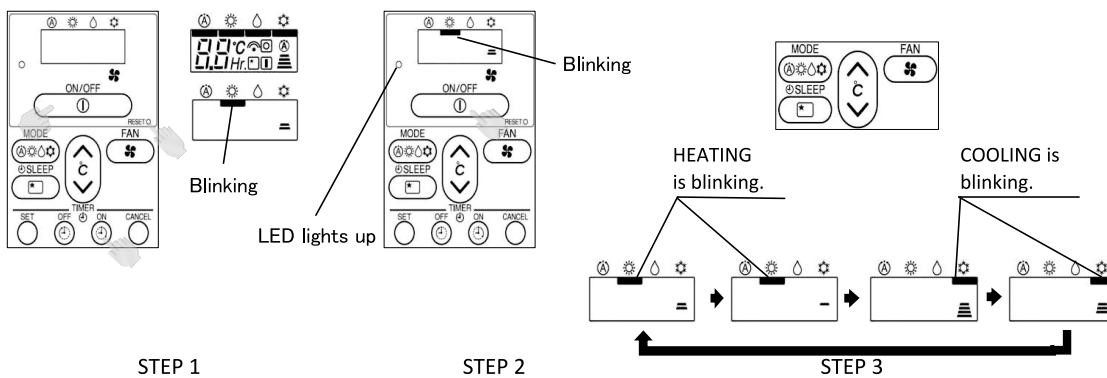

4. Press the **TEMP V or A** button to change the shift value.

Please check the transmission sign.

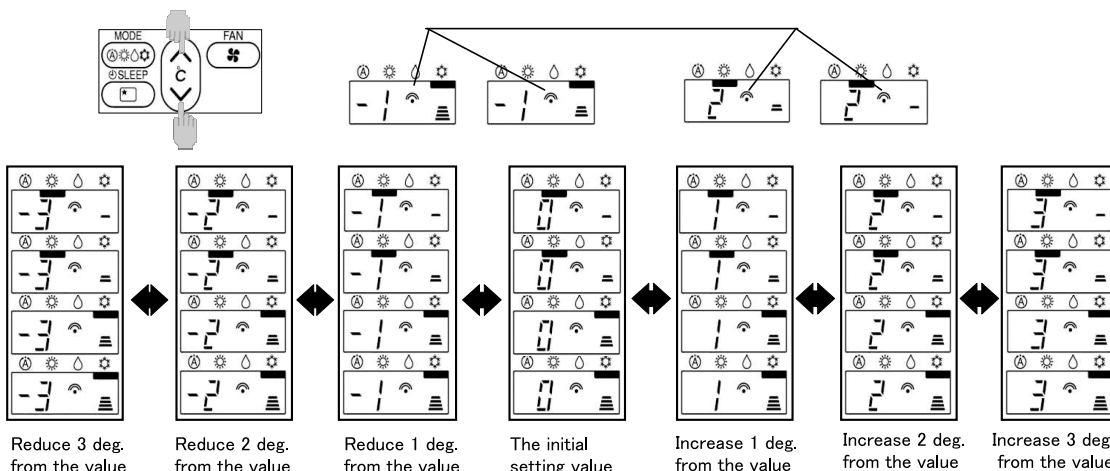

5. Press the **ON/OFF** button to end "Shift value change mode".

## NOTE :

1. Shift value is everytime temperature button is pressed. Maximum 7 shift values only. (-3°C to +3°C)
2. Changed shift value remain even after power supply is switched off.
3. By default the Shift value is set at "0°C" on the remote display. This indicates the unit is set to initial setting.

## SETTING THE PREVENTION OF MUTUAL INTERFERENCE FOR REMOTE CONTROLLER

( Applicable for Remote controller model : RAR-6N1, RAR-6N2, RAR-6N4 and RAR-6N5 )

Case : 2 sets of indoor units installed near to each other.

If both indoor units can receive the same remote controller signal, please set the remote controller as below. ( This setting will change the signal address of each remote controller.)

Initial remote controller signal address setting is **A**.

This procedure change the remote controller signal address from **A** to **B**.

1. The circuit breaker for the other unit shall be OFF.



2. Slide the remote controller cover to take it off.

3. While directing the remote controller towards the receiver of the indoor unit, press **[1-6]** button, **[ON TIMER]** button and **[RESET]** button simultaneously. (The remote controller perform signal transmission with the device.)

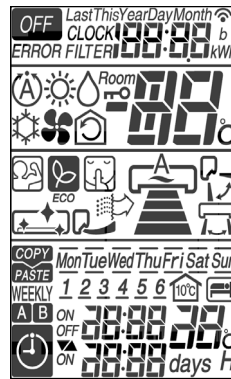
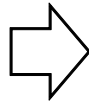

Signal transmission : From A to B

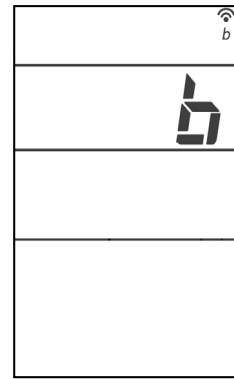

4. The indoor unit beeps [Pip] to indicate that it has just received the signal from remote controller.



5. Please check the usability of each set of indoor unit using its own remote controller.

Note : If indoor unit still not receive the correct signal from the correct remote controller, setting shall be made again.  
By setting again for the 2nd time, the signal address will change from **B** to **A**. Then, if repeat again for the 3rd time, the remote controller signal address will change from **A** to **B**.

Signal transmission : From B to A

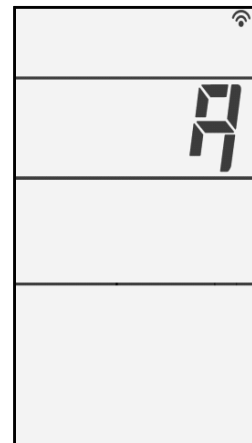







# OPERATION MODE LOCK SETTING

If Dip switch position is set at "Heating mode only" or "Cooling mode only" as mentioned on page 89, it is required to set the remote controller into operation mode lock setting. Without setting the remote controller, it will caused unmatch signal transmission between indoor unit and remote controller.





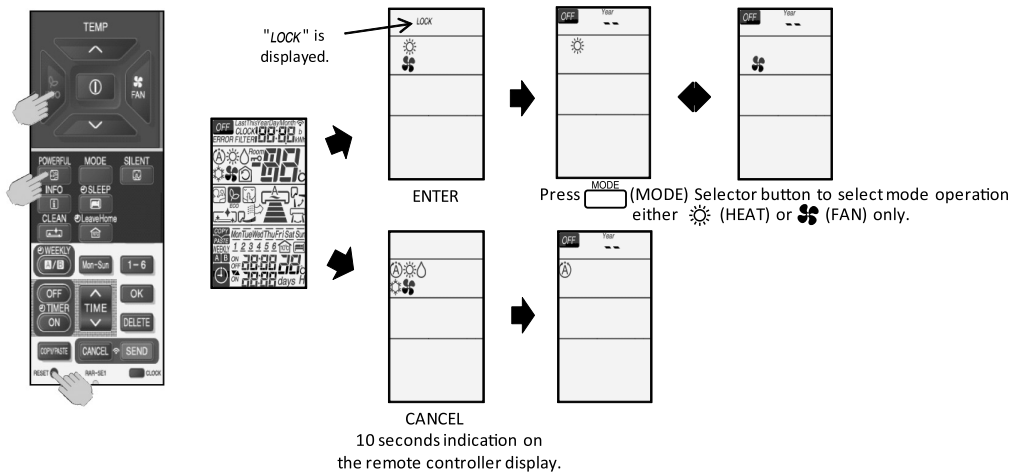

## PROCEDURE

### 1. Heating operation mode lock setting

- (a) While pressing and holding  (ECO) button and  (POWERFUL) button, press  (RESET) button on the same time. Release  (RESET) button only and make sure that all marks on the remote controller display are indicated, then release the  (ECO) button and  (POWERFUL) button. Remote controller now enters "Heating operation mode lock".
- (b) To cancel the "Heating operation mode lock", repeat the above procedure (1(a)).





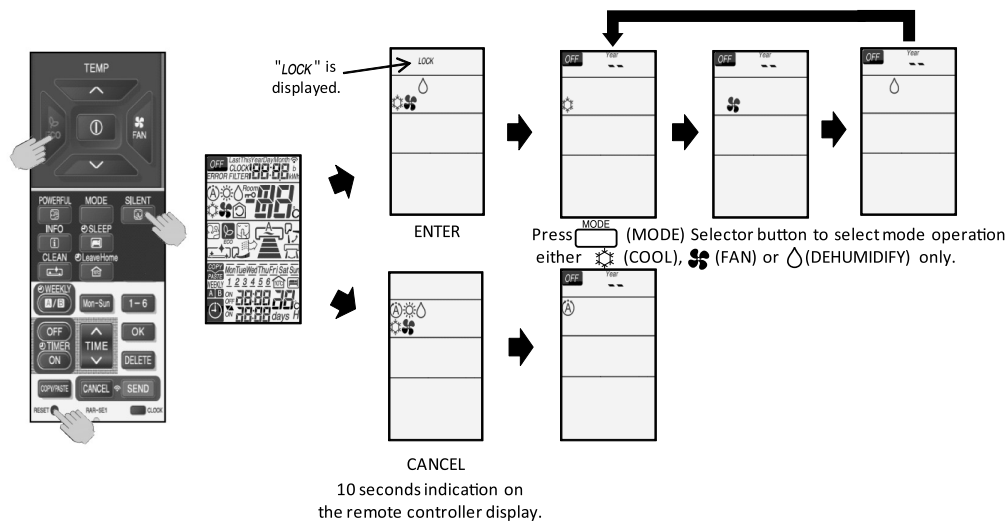

### 2. Cooling operation mode lock setting

- (a) While pressing and holding  (ECO) button and  (SILENT) button, press  (RESET) button on the same time. Release  (RESET) button only and make sure that all marks on the remote controller display are indicated, then release the  (ECO) button and  (SILENT) button. Remote controller now enters "Cooling operation mode lock".
- (b) To cancel the "Cooling operation mode lock", repeat the above procedure (2(a)).











## NOTE :

- (1) The indication of " LOCK " and ("  (HEAT), "  (COOL), "  (FAN) or "  (DEHUMIDIFY)) mode operation symbol on the remote controller display will disappear after 10 seconds and it will enters to OFF condition indicated by  on the display.
- (2) The OPERATION MODE LOCK setting will remain in the remote controller memory eventhough the remote controller is ran out of battery.



# DISPLAY OPERATION MODE SETTING

For operating indoor unit independently (without outdoor unit connection), remote controller has to be set according to below procedures before send the signal to the indoor unit. New communication format between indoor and outdoor is required to communicate with outdoor unit.

## PROCEDURE

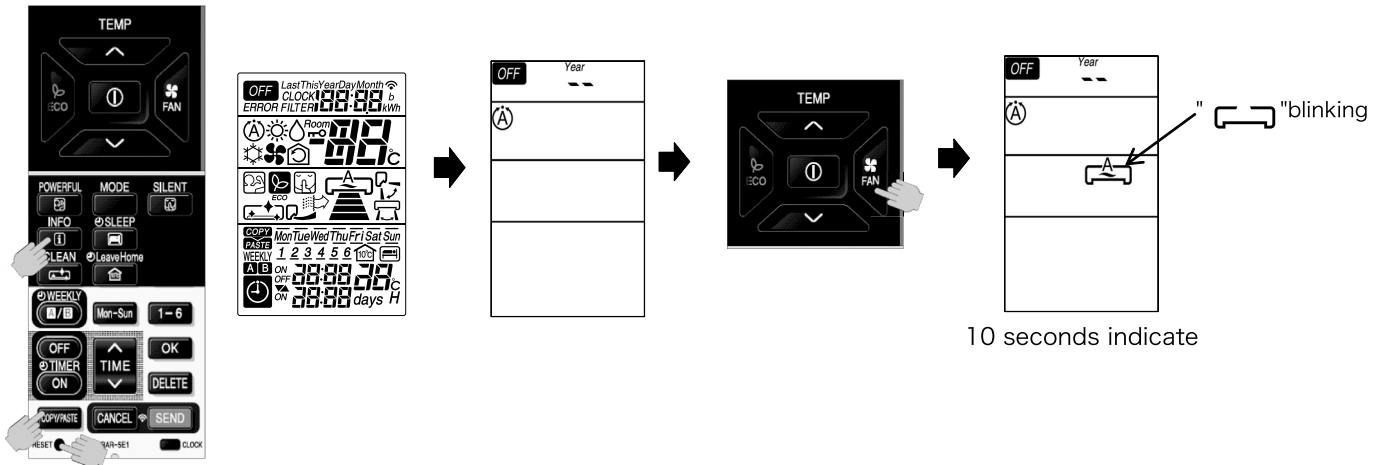
1. While pressing and holding  (INFO) button and  (COPY/PASTE) button, press  (RESET) button on the same time. Release  (RESET) button only and make sure that all marks on the LCD display are indicated, then release the  (INFO) button and  (COPY/PASTE) button. Remote controller now enters "DISPLAY OPERATION MODE" for the indoor unit to run independently. Please ensure that when pressing  (FAN) button, " will blinking.



2. Press the  (MODE) selector button to choose the desired operation mode.
3. Press  (START/STOP) button. Then, the indoor unit will starts to operate independently accoring the selected operation mode.

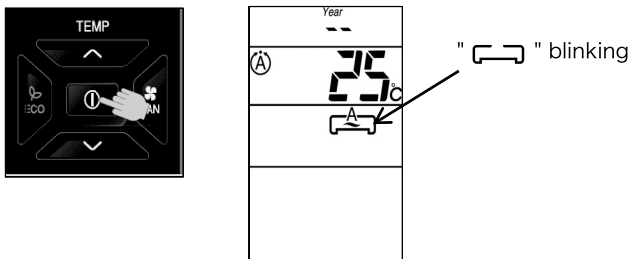

## NOTE :

- (1) During "DISPLAY OPERATION MODE", " blinks on LCD of remote controller.
- (2) When operation stops, "DISPLAY OPERATION MODE" is canceled.

# DISMANTLE AND RE-ASSEMBLE PROCEDURE

■ RAD-18QPB, RAD-25QPB, RAD-35QPB, RAD-50QPB

## 1. Electrical parts

- (1) Remove front grill.
- (2) Remove screws that fixed the electrical cover.
- (3) Remove screws that fixed the electrical assembly.
- (4) Slide up direction to take out the electrical assembly from the plastic guide.

\* If the ondoor unit is a full duct or semi duct type, remove the screws that fixed the plastic guide (4 places) and pull up electrical assembly together with the plastic guide.

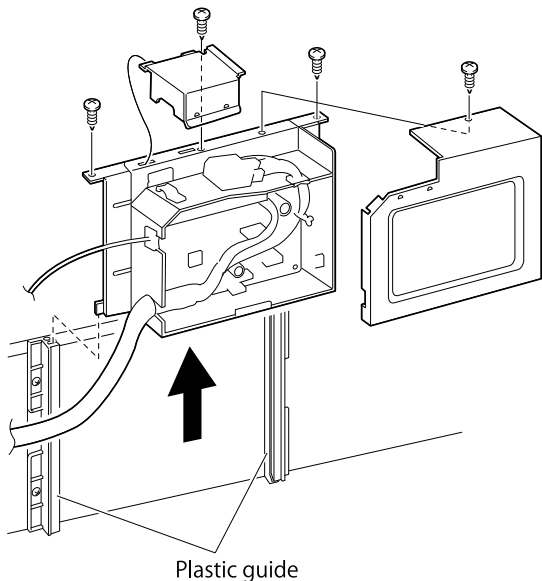

## 2. Si-fan, Fan motor

- (1) Remove screws that fixed the filter (7 places).
- (2) Remove back cover fixing screws (5 places)
- (3) Remove band that fixed the lead wire.
- (4) Remove screw that fixed the lower pipe cover.  
The back cover pulls out backward and removes the pipe lower cover up.

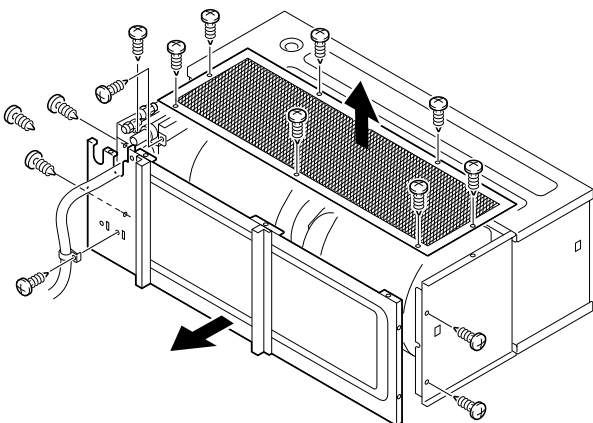

- (5) Disconnect the inter connection connector of fan motor and room thermistor.
- (6) Take out fix plate after remove the screws for fan motor fix plate (6 places).

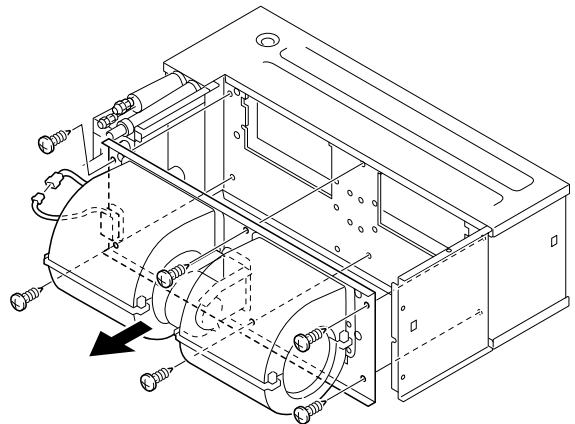

- (7) Remove fan motor casing (4 places).
- (8) Use minus screw driver to release the hooks to separate between upper and lower casing.

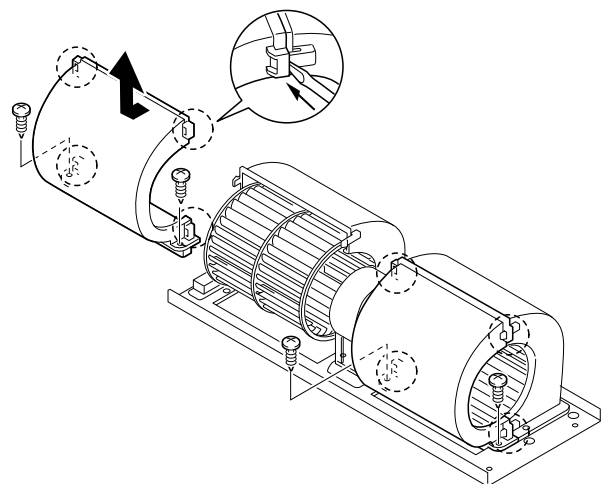

- (9) Take out Si-fan and fan motor after remove the screw that fixed the fan motor support.

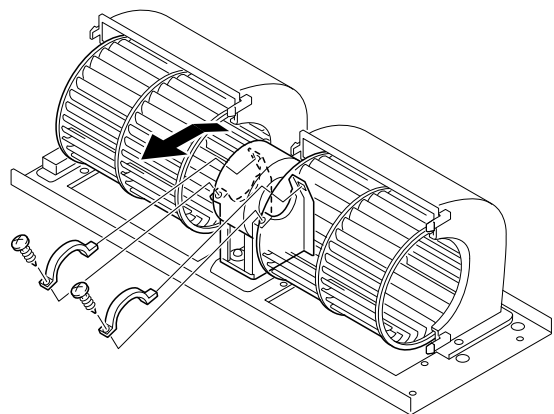

(10) Take out the Si-fan horizontally after loosening the fan fixing screw. (left side also same)

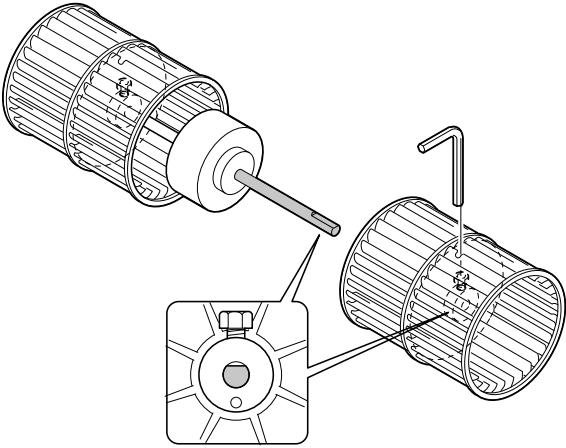

**Caution during assembly**

- Insert the fan to the motor shaft and fix temporary upper casing. Make sure the gap between casing and fan is equal for both side.
- Tighten the fan fixing screw after it touch to the motor shaft d-cut portion.
- Make the fan rotate by hand to confirm that there is no touching with the casing and then fix the casing.

**3. Drain pump**

- (1) Remove top plate fixing screws (6 pieces)
- (2) Take out side plate and styrofoam after remove the right side plate fixing screws (4 pieces).

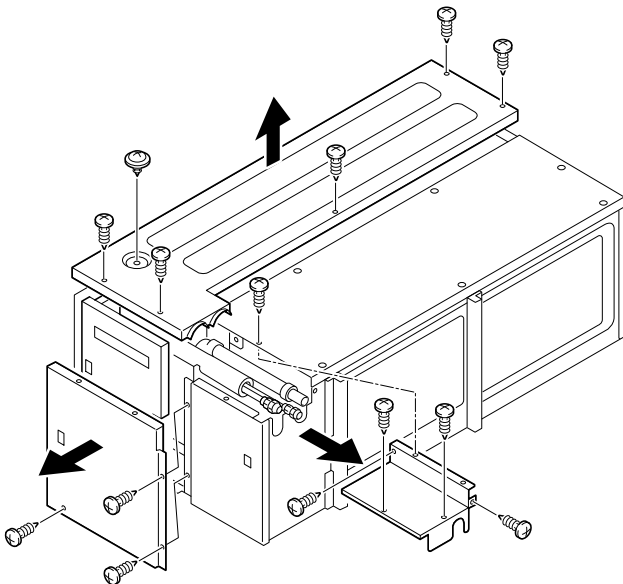

(3) Disconnect lead wire connector for drain pump.

(4) Take out drain pipe after remove the band that fixed the upper portion of drain hose.

(5) Take out the installation plate after remove the screw that fixed the pump installation plate (2 pieces).

(6) Take out the pump after remove the screws that fixed the pump from the installation plate (2 pieces).

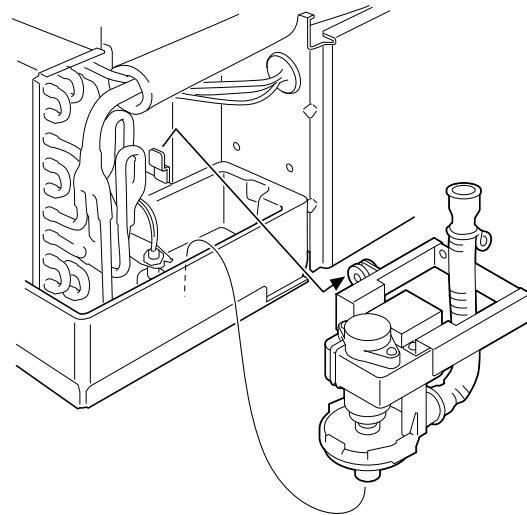
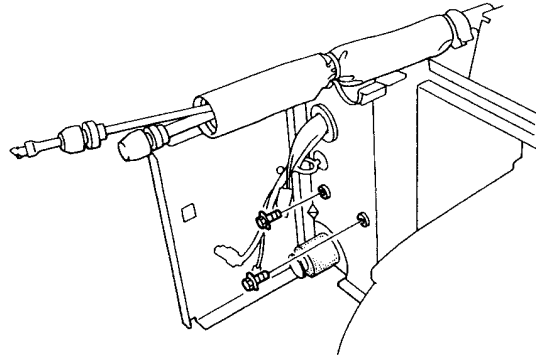

**4. Float switch**

(1) Disconnect lead wire connector for float switch.

(2) Take out switch after loosening the nut of float installation plate.

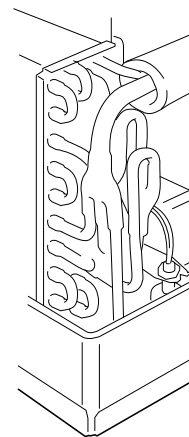



# PARTS LIST AND DIAGRAM

## INDOOR UNIT

MODEL : RAD-18QPB, RAD-25QPB, RAD-35QPB, RAD-50QPB

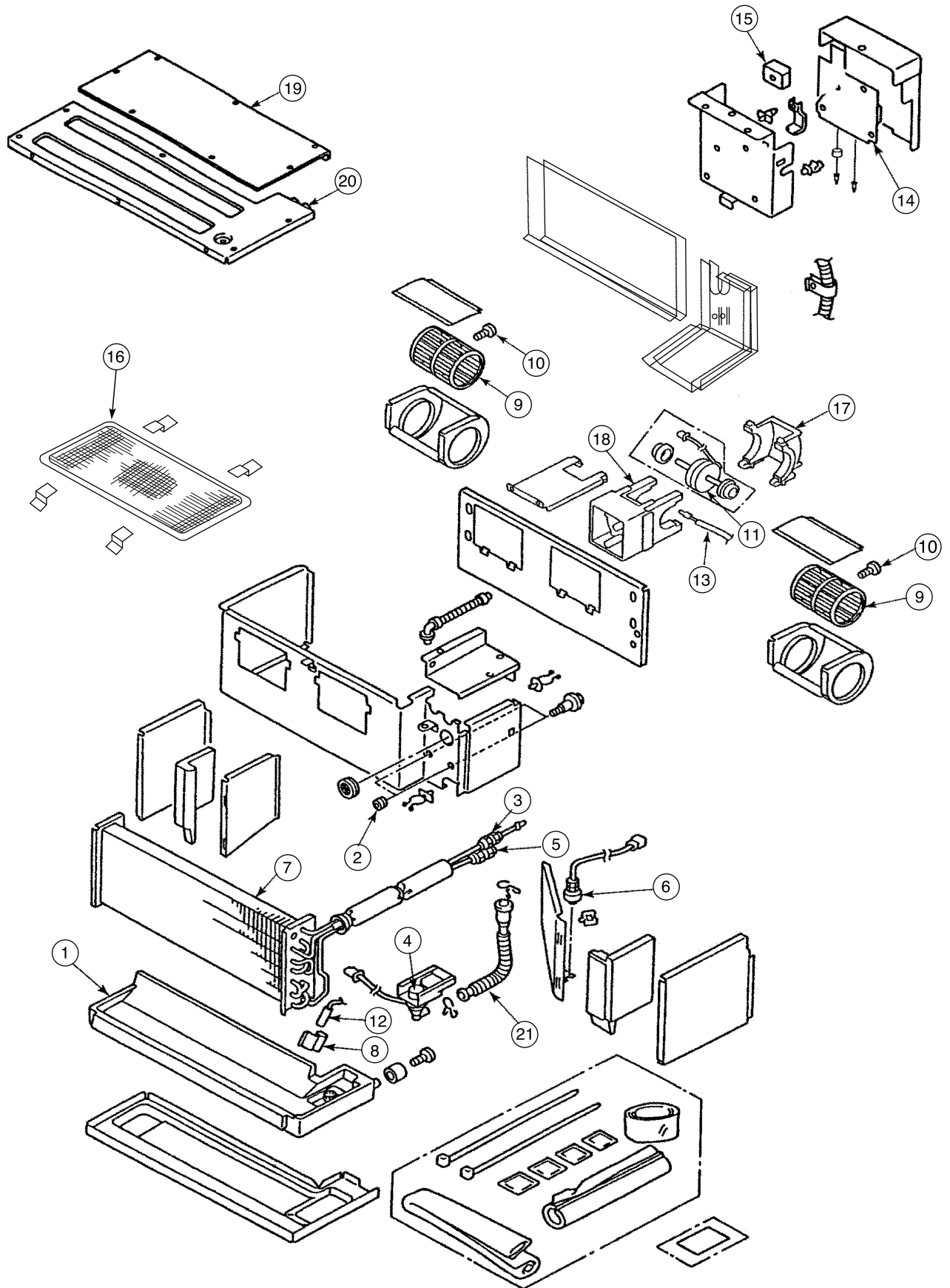





**MODEL RAD-35QPB**

<b>NO.</b>	<b>PART NO. RAD-35QPB</b>	<b>Q'TY / UNIT</b>	<b>PARTS NAME</b>
1	PMRAD-18QPB R13	1	DRAIN PAN
2	PMRAMD-350BW R03	2	FAN MOTOR SUPPORT RUBBER
3	PMRAD-18RPA R04	1	UNION (2)
4	PMRAD-18QPB R09	1	DRAIN PUMP
5	PMRAD-18RPA R05	1	UNION (3)
6	PMRAMD-350BW R11	1	FLOAT SWITCH
7	PMRAD-18QPB R02	1	CYCLE ASSY
8	PMRAD-18QPB R11	1	THERMISTOR SUPPORT
9	PMRAD-18QPB R07	2	SIROCCO FAN
10	PMRA-353B R04	2	FAN BOLT
11	PMRAD-18QPB R06	1	FAN MOTOR
12	PMRAMD-40GX R02	1	THERMISTOR (HEAT)
13	PMRAD-18QPB R08	1	THERMISTOR (TEMPERATURE)
14	PMRAD-35QPB R01	1	P.W.B. (MAIN)
15	PMRAM-18QPB R12	1	TERMINAL BOARD (3P)
16	PMRAD-18NH7 002	1	FILTER
17	PMRAD-18QPB R04	1	FAN MOTOR SUPPORT
18	PMRAD-18QPB R03	1	BASE (FAN MOTOR)
19	PMRAD-18NH7 S03	1	UPPER PLATE (2)
20	PMRAD-18QPB R10	1	UPPER PLATE (1)
21	PMRAD-18QPB R05	1	DRAIN PIPE

**MODEL RAD-50QPB**

<b>NO.</b>	<b>PART NO. RAD-50QPB</b>	<b>Q'TY / UNIT</b>	<b>PARTS NAME</b>
1	PMRAD-18QPB R13	1	DRAIN PAN
2	PMRAMD-350BW R03	2	FAN MOTOR SUPPORT RUBBER
3	PMRAD-18RPA R04	1	UNION (2)
4	PMRAD-18QPB R09	1	DRAIN PUMP
5	PMRAD-50QPB R03	1	UNION (4)
6	PMRAMD-350BW R11	1	FLOAT SWITCH
7	PMRAD-50QPB R02	1	CYCLE ASSY
8	PMRAD-18QPB R11	1	THERMISTOR SUPPORT
9	PMRAD-18QPB R07	2	SIROCCO FAN
10	PMRA-353B R04	2	FAN BOLT
11	PMRAD-18QPB R06	1	FAN MOTOR
12	PMRAMD-40GX R02	1	THERMISTOR (HEAT)
13	PMRAD-18QPB R08	1	THERMISTOR (TEMPERATURE)
14	PMRAD-50QPB R01	1	P.W.B. (MAIN)
15	PMRAM-18QPB R12	1	TERMINAL BOARD (2P)
16	PMRAD-18NH7 002	1	FILTER
17	PMRAD-18QPB R04	1	FAN MOTOR SUPPORT
18	PMRAD-18QPB R03	1	BASE (FAN MOTOR)
19	PMRAD-18NH7 S03	1	UPPER PLATE (2)
20	PMRAD-18QPB R10	1	UPPER PLATE (1)
21	PMRAD-18QPB R05	1	DRAIN PIPE

# HITACHI

---

**RAD-18QPB**  
**RAD-25QPB**  
**RAD-35QPB**  
**RAD-50QPB**

**PM NO. 0600E**

Printed in Malaysia