

DAIKIN

SiBE341001

R-410A

DRAFT

**Service
Manual**

VRV[®] III-Q

**RQYQ140 · 180PY1, RQCYQ280~540PY1
R-410A Heat Pump 50Hz**

**RQCEQ280~848PY1
R-410A Heat Recovery 50Hz**



VRV[®] III-Q R-410A Heat Pump / Heat Recovery 50Hz

| | |
|---------------------------|------|
| 1. Introduction | iv |
| 1.1 Safety Cautions | iv |
| 1.2 PREFACE | viii |

Part 1 General Information 1

| | |
|--|---|
| 1. Model Names of Indoor / Outdoor Units | 2 |
| 2. External Appearance | 3 |
| 2.1 Outdoor Units | 3 |
| 3. Combination of Outdoor Units | 4 |
| 4. Model Selection | 5 |

Part 2 Specifications 6

| | |
|-------------------------|----|
| 1. Specifications | 7 |
| 1.1 Outdoor Units | 7 |
| 1.2 BS Units | 16 |

Part 3 Refrigerant Circuit 18

| | |
|---|----|
| 1. Refrigerant Circuit | 19 |
| 1.1 RQYQ140 · 180PY1, RQEQ140 ~ 212PY1 | 19 |
| 1.2 BS Unit | 21 |
| 2. Functional Parts Layout | 23 |
| 2.1 RQYQ140 · 180PY1, RQEQ140 ~ 212PY1 | 23 |
| 3. Refrigerant Flow for Each Operation Mode | 24 |
| 3.1 RQYQ140 · 180PY1 | 24 |
| 3.2 RQCEQ280 ~ 848PY1 | 27 |

Part 4 Function 34

| | |
|-------------------------------------|----|
| 1. Function General | 35 |
| 1.1 Operation Mode | 35 |
| 1.2 Symbol | 36 |
| 2. Detailed Control Functions | 37 |
| 2.1 Stop Operation | 37 |
| 2.2 Standby | 37 |
| 2.3 Rotation Control | 37 |
| 2.4 Startup Control | 38 |
| 2.5 Normal Operation | 39 |
| 2.6 Protection Control | 47 |
| 2.7 Special Control | 52 |

Part 5 Test Operation 61

| | |
|---------------------------------|----|
| 1. Test Operation | 62 |
| 1.1 Procedure and Outline | 62 |

| | | |
|-----|--------------------------------------|----|
| 1.2 | Check Operation | 65 |
| 1.3 | Checking in Normal Operation | 68 |
| 2. | Field Setting from Outdoor Unit..... | 69 |
| 2.1 | Field Setting from Outdoor Unit..... | 69 |

Part 6 Troubleshooting 92

| | | |
|------|---|-----|
| 1. | Symptom-based Troubleshooting | 94 |
| 2. | Troubleshooting by Remote Controller | 97 |
| 2.1 | The INSPECTION / TEST Button..... | 97 |
| 2.2 | Self-diagnosis by Wired Remote Controller | 98 |
| 2.3 | Remote Controller Service Mode | 99 |
| 2.4 | Test Run Mode..... | 102 |
| 2.5 | Remote Controller Self-Diagnosis Function | 102 |
| 2.6 | “E1” Outdoor Unit: PCB Defect | 110 |
| 2.7 | “E2” Outdoor Unit: Actuation of High Pressure Switch..... | 111 |
| 2.8 | “E3” Outdoor Unit: Actuation of High Pressure Switch..... | 112 |
| 2.9 | “E4” Outdoor Unit: Actuation of Low Pressure Sensor..... | 114 |
| 2.10 | “E5” Outdoor Unit: Inverter Compressor Motor Lock..... | 116 |
| 2.11 | “E7” Outdoor Unit: Malfunction of Outdoor Unit Fan Motor | 118 |
| 2.12 | “E9” Outdoor Unit: Malfunction of Electronic Expansion Valve Coil (Y1E~Y3E) | 121 |
| 2.13 | “F3” Outdoor Unit: Abnormal Discharge Pipe Temperature..... | 123 |
| 2.14 | “F4” Outdoor Unit: Humidity alarm | 125 |
| 2.15 | “F9” Outdoor Unit : Malfunction of BS Unit Electronic Expansion Valve..... | 127 |
| 2.16 | “H7” Outdoor Unit: Abnormal Outdoor Fan Motor Signal | 129 |
| 2.17 | “H9” Outdoor Unit: Malfunction of Thermistor (R1T) for Outdoor Air..... | 131 |
| 2.18 | “J3, J4, J5, J6, J7, J8, J9” Outdoor Unit: Malfunction of Outdoor unit Thermistor | 132 |
| 2.19 | “L9” Outdoor Unit: Malfunction of High Pressure Sensor..... | 134 |
| 2.20 | “L” Outdoor Unit: Malfunction of Low Pressure Sensor | 136 |
| 2.21 | “L1” Outdoor Unit: Malfunction of Inverter PCB | 138 |
| 2.22 | “L4” Outdoor Unit: Malfunction of Inverter Radiating Fin Temperature Rise..... | 140 |
| 2.23 | “L5” Outdoor Unit: Momentary Overcurrent of Inverter Compressor | 142 |
| 2.24 | “L8” Outdoor Unit: Momentary Overcurrent of Inverter Compressor | 144 |
| 2.25 | “L9” Outdoor Unit: Inverter Compressor Starting Failure | 146 |
| 2.26 | “L” Outdoor Unit: Malfunction of Transmission between Inverter and Main PCB | 149 |
| 2.27 | “P1” Outdoor Unit: Inverter Over-Ripple Protection..... | 151 |
| 2.28 | “P4” Outdoor Unit: Malfunction of Inverter Radiating Fin Temperature Rise Sensor | 153 |
| 2.29 | “P” Outdoor Unit: Faulty Field Setting after Replacing Main PCB or Faulty Combination of PCB | 154 |
| 2.30 | “U1” Reverse Phase, Open Phase..... | 156 |
| 2.31 | “U2” Outdoor Unit: Power Supply Insufficient or Instantaneous Failure..... | 157 |
| 2.32 | “U3” Outdoor Unit: Check Operation is not Executed..... | 160 |
| 2.33 | “U4” Malfunction of Transmission between Indoor Units and Outdoor Units | 162 |
| 2.34 | “U7” Outdoor Unit: Transmission Failure (Across Outdoor Units) | 165 |

| | |
|--|-----|
| 2.35 “U3” Indoor Unit: Malfunction of Transmission between Main and Sub Remote Controllers | 172 |
| 2.36 “U3” Indoor Unit: Malfunction of Transmission between Indoor and Outdoor Units in the Same System | 173 |
| 2.37 “U3” Improper Combination of Indoor, BS and Outdoor Units, Indoor Units and Remote Controller | 174 |
| 2.38 “U4” Address Duplication of Centralized Controller | 182 |
| 2.39 “U5” Malfunction of Transmission between Centralized Controller and Indoor Unit | 183 |
| 2.40 “U6” System is not Set yet | 186 |
| 2.41 “U7” Malfunction of System, Refrigerant System Address Undefined ... | 187 |





Part 7 Appendix..... 205

| | |
|--|-----|
| 1. Piping Diagrams | 206 |
| 1.1 Outdoor Unit | 206 |
| 1.2 BS Unit | 207 |
| 2. Wiring Diagrams for Reference | 210 |
| 2.1 Outdoor Unit | 210 |
| 2.2 BS Unit | 211 |
| 3. Option List | 214 |
| 3.1 Option Lists (Outdoor Unit) | 214 |
| 4. Example of connection (R-410A Type) | 216 |







1. Introduction









1.1 Safety Cautions

Cautions and Warnings

- Be sure to read the following safety cautions before conducting repair work.
- The caution items are classified into “ **Warning**” and “ **Caution**”. The “ **Warning**” items are especially important since they can lead to death or serious injury if they are not followed closely. The “ **Caution**” items can also lead to serious accidents under some conditions if they are not followed. Therefore, be sure to observe all the safety caution items described below.
- About the pictograms
 - △ This symbol indicates an item for which caution must be exercised.
The pictogram shows the item to which attention must be paid.
 - This symbol indicates a prohibited action.
The prohibited item or action is shown inside or near the symbol.
 - This symbol indicates an action that must be taken, or an instruction.
The instruction is shown inside or near the symbol.
- After the repair work is complete, be sure to conduct a test operation to ensure that the equipment operates normally, and explain the cautions for operating the product to the customer

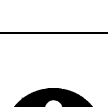

1.1.1 Caution in Repair



|  Warning | |
|--|---|
| <p>Be sure to disconnect the power cable plug from the plug socket before disassembling the equipment for a repair. Working on the equipment that is connected to a power supply can cause an electrical shock. If it is necessary to supply power to the equipment to conduct the repair or inspecting the circuits, do not touch any electrically charged sections of the equipment.</p> |  |
| <p>If the refrigerant gas discharges during the repair work, do not touch the discharging refrigerant gas. The refrigerant gas can cause frostbite.</p> |  |
| <p>When disconnecting the suction or discharge pipe of the compressor at the welded section, release the refrigerant gas completely at a well-ventilated place first. If there is a gas remaining inside the compressor, the refrigerant gas or refrigerating machine oil discharges when the pipe is disconnected, and it can cause injury.</p> | |
| <p>If the refrigerant gas leaks during the repair work, ventilate the area. The refrigerant gas can generate toxic gases when it contacts flames.</p> |  |
| <p>The step-up capacitor supplies high-voltage electricity to the electrical components of the outdoor unit. Be sure to discharge the capacitor completely before conducting repair work. A charged capacitor can cause an electrical shock.</p> |  |
| <p>Do not start or stop the air conditioner operation by plugging or unplugging the power cable plug. Plugging or unplugging the power cable plug to operate the equipment can cause an electrical shock or fire.</p> |  |

|  Caution | |
|---|---|
| Do not repair the electrical components with wet hands. Working on the equipment with wet hands can cause an electrical shock. |  |
| Do not clean the air conditioner by splashing water. Washing the unit with water can cause an electrical shock. |  |
| Be sure to provide the grounding when repairing the equipment in a humid or wet place, to avoid electrical shocks. |  |
| Be sure to turn off the power switch and unplug the power cable when cleaning the equipment. The internal fan rotates at a high speed, and cause injury. |  |
| Do not tilt the unit when removing it. The water inside the unit can spill and wet the furniture and floor. |  |
| Be sure to check that the refrigerating cycle section has cooled down sufficiently before conducting repair work. Working on the unit when the refrigerating cycle section is hot can cause burns. |  |
| Use the welder in a well-ventilated place. Using the welder in an enclosed room can cause oxygen deficiency. |  |





1.1.2 Cautions Regarding Products after Repair



|  Warning | |
|--|-------------------------|
| Be sure to use parts listed in the service parts list of the applicable model and appropriate tools to conduct repair work. Never attempt to modify the equipment. The use of inappropriate parts or tools can cause an electrical shock, excessive heat generation or fire. | |
| When relocating the equipment, make sure that the new installation site has sufficient strength to withstand the weight of the equipment. If the installation site does not have sufficient strength and if the installation work is not conducted securely, the equipment can fall and cause injury. | |
| Be sure to install the product correctly by using the provided standard installation frame. Incorrect use of the installation frame and improper installation can cause the equipment to fall, resulting in injury. | For integral units only |
| Be sure to install the product securely in the installation frame mounted on a window frame. If the unit is not securely mounted, it can fall and cause injury. | For integral units only |
| Be sure to use an exclusive power circuit for the equipment, and follow the technical standards related to the electrical equipment, the internal wiring regulations and the instruction manual for installation when conducting electrical work. Insufficient power circuit capacity and improper electrical work can cause an electrical shock or fire. | |

|  Warning | |
|--|---|
| Be sure to use the specified cable to connect between the indoor and outdoor units. Make the connections securely and route the cable properly so that there is no force pulling the cable at the connection terminals. Improper connections can cause excessive heat generation or fire. | |
| When connecting the cable between the indoor and outdoor units, make sure that the terminal cover does not lift off or dismount because of the cable. If the cover is not mounted properly, the terminal connection section can cause an electrical shock, excessive heat generation or fire. | |
| Do not damage or modify the power cable. Damaged or modified power cable can cause an electrical shock or fire. Placing heavy items on the power cable, and heating or pulling the power cable can damage the cable. |  |
| Do not mix air or gas other than the specified refrigerant (R-410A) in the refrigerant system. If air enters the refrigerating system, an excessively high pressure results, causing equipment damage and injury. | |
| If the refrigerant gas leaks, be sure to locate the leak and repair it before charging the refrigerant. After charging refrigerant, make sure that there is no refrigerant leak. If the leak cannot be located and the repair work must be stopped, be sure to perform pump down and close the service valve, to prevent the refrigerant gas from leaking into the room. The refrigerant gas itself is harmless, but it can generate toxic gases when it contacts flames, such as fan and other heaters, stoves and ranges. |  |
| When replacing the coin battery in the remote controller, be sure to disposed of the old battery to prevent children from swallowing it. If a child swallows the coin battery, see a doctor immediately. | |

|  Caution | |
|--|---|
| Installation of a leakage breaker is necessary in some cases depending on the conditions of the installation site, to prevent electrical shocks. | |
| Do not install the equipment in a place where there is a possibility of combustible gas leaks. If a combustible gas leaks and remains around the unit, it can cause a fire. |  |
| Be sure to install the packing and seal on the installation frame properly. If the packing and seal are not installed properly, water can enter the room and wet the furniture and floor. | For integral units only |

1.1.3 Inspection after Repair





|  Warning | |
|--|---|
| Check to make sure that the power cable plug is not dirty or loose, then insert the plug into a power outlet all the way. If the plug has dust or loose connection, it can cause an electrical shock or fire. |  |
| If the power cable and lead wires have scratches or deteriorated, be sure to replace them. Damaged cable and wires can cause an electrical shock, excessive heat generation or fire. |  |
| Do not use a joined power cable or extension cable, or share the same power outlet with other electrical appliances, since it can cause an electrical shock, excessive heat generation or fire. |  |

|  Caution | |
|---|---|
| Check to see if the parts and wires are mounted and connected properly, and if the connections at the soldered or crimped terminals are secure. Improper installation and connections can cause excessive heat generation, fire or an electrical shock. | |
| If the installation platform or frame has corroded, replace it. Corroded installation platform or frame can cause the unit to fall, resulting in injury. | |
| Check the grounding, and repair it if the equipment is not properly grounded. Improper grounding can cause an electrical shock. |  |
| Be sure to measure the insulation resistance after the repair, and make sure that the resistance is 1 Mohm or higher. Faulty insulation can cause an electrical shock. | |
| Be sure to check the drainage of the indoor unit after the repair. Faulty drainage can cause the water to enter the room and wet the furniture and floor. | |

1.1.4 Using Icons

Icons are used to attract the attention of the reader to specific information. The meaning of each icon is described in the table below:

1.1.5 Using Icons List

| Icon | Type of Information | Description |
|---|---------------------|--|
|  Note: | Note | A “note” provides information that is not indispensable, but may nevertheless be valuable to the reader, such as tips and tricks. |
|  Caution | Caution | A “caution” is used when there is danger that the reader, through incorrect manipulation, may damage equipment, lose data, get an unexpected result or has to restart (part of) a procedure. |
|  Warning | Warning | A “warning” is used when there is danger of personal injury. |
|  | Reference | A “reference” guides the reader to other places in this binder or in this manual, where he/she will find additional information on a specific topic. |

1.2 PREFACE

Thank you for your continued patronage of Daikin products.

This is the new service manual for Daikin's Year 2010 VRVIII-Q series Heat Pump System. Daikin offers a wide range of models to respond to building and office air conditioning needs. We are confident that customers will be able to find the models that best suit their needs.

This service manual contains information regarding the servicing of VRVIII-Q series R-410A Heat Pump, Heat Recovery System.

March, 2010

After Sales Service Division

Part 1

General Information

| | |
|---|---|
| 1. Model Names of Indoor / Outdoor Units..... | 2 |
| 2. External Appearance..... | 3 |
| 2.1 Outdoor Units | 3 |
| 3. Combination of Outdoor Units..... | 4 |
| 4. Model Selection..... | 5 |

1. Model Names of Indoor / Outdoor Units

Outdoor Unit

| Series | Model Name | | | | Power Supply |
|---------------|------------|------|------|------|--------------|
| Heat Pump | RQYQ | 140P | 180P | | Y1 |
| Heat Recovery | RQEQ | 140P | 180P | 212P | |



BS Unit

| Type | Model Name | | | | Power Supply |
|----------------------|------------|--------|--------|------|--------------|
| Heat Recovery Series | BSVQ | 100P | 160P | 250P | V18 |
| | BSV | 4Q100P | 6Q100P | | V1 |

Power Supply: Y1 : 3 ϕ , 380~415V, 50Hz
 V1 : 1 ϕ , 220~240V, 50Hz

2. External Appearance

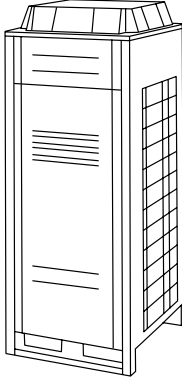
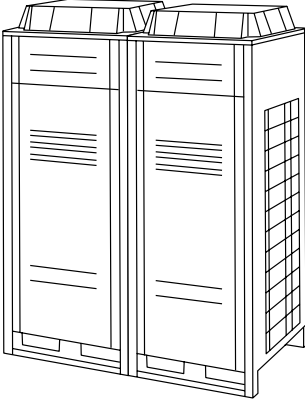
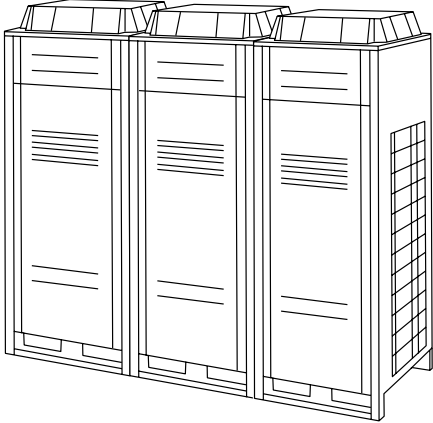
2.1 Outdoor Units

| <p>RQYQ140, 180PY1 RREQ140, 180, 212PY1</p> | <p>RQCYQ280, 360PY1 RQCEQ280, 360PY1</p> |
|--|---|
|  <p data-bbox="397 864 531 891">5, 6.5, 7.5 HP</p> |  <p data-bbox="1078 864 1181 891">10, 13 HP</p> |
| <p>RQCYQ460, 500, 540PY1 RQCEQ460, 500, 540, 636PY1</p> | <p>RQCEQ712, 744, 816, 848PY1</p> |
|  <p data-bbox="381 1547 547 1574">16, 18, 20, 22 HP</p> |  <p data-bbox="1042 1547 1208 1574">24, 26, 28, 30 HP</p> |

3. Combination of Outdoor Units

Heat Pump Series

| System Capacity | Number of Units | RQYQ140PY1 | RQYQ180PY1 | Outdoor Unit Multi Connection Piping Kit (Option) |
|-----------------|-----------------|------------|------------|---|
| 5HP | 1 | ● | | — |
| 6.5HP | 1 | | ● | |
| 10HP | 2 | ●● | | BHFP22P36C |
| 13HP | 2 | | ●● | |
| 16HP | 3 | ●● | ● | BHFP22P54C |
| 18HP | 3 | ● | ●● | |
| 20HP | 3 | | ●●● | |

Heat Recovery Series

| System Capacity | Number of Units | RREQ140PY1 | RREQ180PY1 | RREQ212PY1 | Outdoor Unit Multi Connection Piping Kit (Option) |
|-----------------|-----------------|------------|------------|------------|---|
| 10HP | 2 | ●● | | | BHFP26P36C |
| 13HP | 2 | | ●● | | |
| 16HP | 3 | ●● | ● | | BHFP26P63C |
| 18HP | 3 | ● | ●● | | |
| 20HP | 3 | | ●●● | | |
| 22HP | 3 | | | ●●● | BHFP26P84C |
| 24HP | 4 | ● | ●● | ● | |
| 26HP | 4 | ● | ● | ●● | |
| 28HP | 4 | | ● | ●●● | |
| 30HP | 4 | | | ●●●● | |

4. Model Selection

VRV III Heat Recovery Series

Connectable indoor units number and capacity Heat Pump Series

| HP | 5HP | 6.5HP | 10HP | 13HP | 16HP | 18HP | 20HP |
|---|------------|------------|-------------|-------------|-------------|-------------|-------------|
| System name | RQYQ140PY1 | RQYQ180PY1 | RQCYQ280PY1 | RQCYQ360PY1 | RQCYQ460PY1 | RQCYQ500PY1 | RQCYQ540PY1 |
| Outdoor unit 1 | RQYQ140PY1 | RQYQ180PY1 | RQYQ140PY1 | RQYQ180PY1 | RQYQ140PY1 | RQYQ140PY1 | RQYQ180PY1 |
| Outdoor unit 2 | – | – | RQYQ140PY1 | RQYQ180PY1 | RQYQ140PY1 | RQYQ180PY1 | RQYQ180PY1 |
| Outdoor unit 3 | – | – | – | – | RQYQ180PY1 | RQYQ180PY1 | RQYQ180PY1 |
| Total number of connectable indoor units | 8 | 10 | 16 | 20 | 26 | 29 | 33 |
| Total capacity of connectable indoor units (kW) | 7.0 ~ 18.2 | 9.0 ~ 23.4 | 14.0 ~ 36.4 | 17.8 ~ 46.2 | 22.5 ~ 58.5 | 25.0 ~ 65.0 | 28.0 ~ 72.8 |

Heat Recovery Series

| HP | 10HP | 13HP | 16HP | 18HP | 20HP | 22HP | 24HP | 26HP | 28HP | 30HP |
|---|--------------|--------------|--------------|--------------|--------------|--------------|--------------|--------------|--------------|--------------|
| System name | RQCEQ 280PY1 | RQCEQ 360PY1 | RQCEQ 460PY1 | RQCEQ 500PY1 | RQCEQ 540PY1 | RQCEQ 636PY1 | RQCEQ 712PY1 | RQCEQ 744PY1 | RQCEQ 816PY1 | RQCEQ 848PY1 |
| Outdoor unit 1 | RREQ 140PY1 | RREQ 180PY1 | RREQ 180PY1 | RREQ 180PY1 | RREQ 180PY1 | RREQ 212PY1 | RREQ 212PY1 | RREQ 212PY1 | RREQ 212PY1 | RREQ 212PY1 |
| Outdoor unit 2 | RREQ 140PY1 | RREQ 180PY1 | RREQ 140PY1 | RREQ 180PY1 | RREQ 180PY1 | RREQ 212PY1 | RREQ 180PY1 | RREQ 212PY1 | RREQ 212PY1 | RREQ 212PY1 |
| Outdoor unit 3 | – | – | RREQ 140PY1 | RREQ 140PY1 | RREQ 180PY1 | RREQ 212PY1 | RREQ 180PY1 | RREQ 180PY1 | RREQ 212PY1 | RREQ 212PY1 |
| Outdoor unit 4 | – | – | – | – | – | – | RREQ 140PY1 | RREQ 140PY1 | RREQ 180PY1 | RREQ 212PY1 |
| Total number of connectable indoor units | 16 | 20 | 26 | 29 | 33 | 36 | 40 | 43 | 47 | 50 |
| Total capacity of connectable indoor units (kW) | 14.0 ~ 36.4 | 18.0 ~ 46.2 | 23.0 ~ 59.8 | 25.0 ~ 65.0 | 27.0 ~ 70.2 | 31.8 ~ 82.7 | 35.6 ~ 92.6 | 37.2 ~ 96.7 | 40.8 ~ 106 | 42.4 ~ 110 |

Part 2 Specifications

| | |
|-------------------------|----|
| 1. Specifications | 7 |
| 1.1 Outdoor Units | 7 |
| 1.2 BS Units | 16 |

1. Specifications

1.1 Outdoor Units

Heat Pump Series <RQ(C)YQ-P>

| Model Name | | RQYQ140PY1 | RQYQ180PY1 |
|----------------------|------------------------------|---|---|
| ★1 Cooling Capacity | kcal / h | 12,000 | 15,500 |
| | Btu / h | 47,800 | 61,400 |
| | kW | 14.0 | 18.0 |
| ★2 Heating Capacity | kcal / h | 13,800 | 17,200 |
| | Btu / h | 54,600 | 68,200 |
| | kW | 16.0 | 20.0 |
| Casing Color | | Ivory White 5Y7.5/1 | Ivory White 5Y7.5/1 |
| Dimensions: (HxWxD) | | mm 1680x635x765 | 1680x635x765 |
| Heat Exchanger | | Cross Fin Coil | Cross Fin Coil |
| Comp. | Type | | Hermetically Sealed Scroll Type |
| | Piston Displacement | m ³ /h | 13.34 |
| | Number of Revolutions | r.p.m | 6,300 |
| | Motor Output×Number of Units | kW | 2.8×1 |
| | Starting Method | | Soft Start |
| Fan | Type | | Propellor Fan |
| | Motor Output | kW | 0.35×1 |
| | Airflow Rate | m ³ /min | 95 |
| | Drive | | Direct Drive |
| Connecting Pipes | Liquid Pipe | | φ9.5 C1220T (Brazing Connection) |
| | Gas Pipe | | φ15.9 C1220T (Brazing Connection) |
| Mass (Weight) | | kg 175 | 175 |
| Safety Devices | | High Pressure Switch, Fan Driver Overload Protector, Overcurrent Relay, Inverter Overload Protector | High Pressure Switch, Fan Driver Overload Protector, Overcurrent Relay, Inverter Overload Protector |
| Defrost Method | | Deicer | Deicer |
| Capacity Control | | % 25~100 | 21~100 |
| Refrigerant | Refrigerant Name | | R-410A |
| | Charge | kg | 11.1 |
| | Control | | Electronic Expansion Valve |
| Refrigerator Oil | | Refer to the nameplate of compressor | Refer to the nameplate of compressor |
| Standard Accessories | | Installation Manual, Operation Manual, Clamps | Installation Manual, Operation Manual, Connection Pipes, Clamps |
| Drawing No. | | 4D066320A | 4D066321A |

Notes:

- ★1 Indoor temp. : 27°CDB, 19.0°CWB / outdoor temp. : 35°CDB / Equivalent piping length : 7.5m, level difference : 0m.
 ★2 Indoor temp. : 20°CDB / outdoor temp. : 7°CDB, 6°CWB / Equivalent piping length : 7.5m, level difference : 0m.

| Conversion Formulae |
|------------------------------|
| kcal/h=kW×860 |
| Btu/h=kW×3412 |
| cfm=m ³ /min×35.3 |

| Model Name (Combination Unit) | | RQCYQ280PY1 | | RQCYQ360PY1 | | |
|-------------------------------|------------------------------|---|------------------------------------|---|------------------------------------|--|
| Model Name (Independent Unit) | | RQYQ140PY1+RQYQ140PY1 | | RQYQ180PY1+RQYQ180PY1 | | |
| ★1 Cooling Capacity | kcal / h | 24,000 | | 31,000 | | |
| | Btu / h | 95,600 | | 122,800 | | |
| | kW | 28.0 | | 36.0 | | |
| ★2 Heating Capacity | kcal / h | 27,600 | | 34,400 | | |
| | Btu / h | 109,200 | | 136,400 | | |
| | kW | 32.0 | | 40.0 | | |
| Casing Color | | Ivory White 5Y7.5/1 | | Ivory White 5Y7.5/1 | | |
| Dimensions: (H×W×D) | | mm | 1680×635×765+1680×635×765 | | 1680×635×765+1680×635×765 | |
| Heat Exchanger | | Cross fin coil | | Cross fin coil | | |
| Comp. | Type | | Hermetically sealed scroll type | | Hermetically sealed scroll type | |
| | Piston Displacement | m ³ /h | 13.34+13.34 | | 15.75+15.75 | |
| | Number of Revolutions | r.p.m | 6300, 6300 | | 7440, 7440 | |
| | Motor Output×Number of Units | kW | (2.8×1)+(2.8×1) | | (3.3×1)+(3.3×1) | |
| | Starting Method | | Soft start | | Soft start | |
| Fan | Type | | Propellor fan | | Propellor fan | |
| | Motor Output | kW | (0.35×1)+(0.35×1) | | (0.35×1)+(0.35×1) | |
| | Airflow Rate | m ³ /min | 95+95 | | 110+110 | |
| | Drive | | Direct drive | | Direct drive | |
| Connecting Pipes | Liquid Pipe | | φ9.5 C1220T (Brazeing connection) | | φ12.7 C1220T (Brazeing connection) | |
| | Gas Pipe | | φ22.2 C1220T (Brazeing connection) | | φ25.4 C1220T (Brazeing connection) | |
| Mass (Weight) | | kg | 175+175 | | 175+175 | |
| Safety Devices | | High pressure switch, fan driver overload protector, overcurrent relay, inverter overload protector | | High pressure switch, fan driver overload protector, overcurrent relay, inverter overload protector | | |
| Defrost Method | | Deicer | | Deicer | | |
| Capacity Control | | % | 12-100 | | 10-100 | |
| Refrigerant | Refrigerant Name | | R-410A | | R-410A | |
| | Charge | kg | 11.1+11.1 | | 11.1+11.1 | |
| | Control | | Electronic expansion valve | | Electronic expansion valve | |
| Refrigerator Oil | | Refer to the nameplate of compressor | | Refer to the nameplate of compressor | | |
| Standard Accessories | | Installation manual, Operation manual, Connection pipes, Cramps | | Installation manual, Operation manual, Connection pipes, Cramps | | |
| Drawing No. | | | | | | |

Notes:

- ★1 Indoor temp. : 27°CDB, 19.0°CWB / outdoor temp. : 35°CDB / Equivalent piping length : 7.5m, level difference : 0m.
★2 Indoor temp. : 20°CDB / outdoor temp. : 7°CDB, 6°CWB / Equivalent piping length : 7.5m, level difference : 0m.

| Conversion Formulae |
|------------------------------|
| kcal/h=kW×860 |
| Btu/h=kW×3412 |
| cfm=m ³ /min×35.3 |

| Model Name (Combination Unit) | | RQCQY460PY1 | | RQCQY500PY1 | | | |
|-------------------------------|------------------------------|---|--|---|--|-------------------------|--|
| Model Name (Independent Unit) | | RQYQ180PY1+RQYQ140PY1+RQYQ140PY1 | | RQYQ180PY1+RQYQ180PY1+RQYQ140PY1 | | | |
| ★1 Cooling Capacity | kcal / h | 39,600 | | 43,000 | | | |
| | Btu / h | 157,000 | | 170,600 | | | |
| | kW | 46.0 | | 50.0 | | | |
| ★2 Heating Capacity | kcal / h | 44,700 | | 48,200 | | | |
| | Btu / h | 177,400 | | 191,100 | | | |
| | kW | 52.0 | | 56.0 | | | |
| Casing Color | | Ivory White 5Y7.5/1 | | Ivory White 5Y7.5/1 | | | |
| Dimensions: (H×W×D) | | mm | 1680×635×765+1680×635×765+1680×635×765 | | 1680×635×765+1680×635×765+1680×635×765 | | |
| Heat Exchanger | | Cross fin coil | | Cross fin coil | | | |
| Comp. | Type | | Hermetically sealed scroll type | | Hermetically sealed scroll type | | |
| | Piston Displacement | m³/h | (15.75×1)+(13.34×1)+(13.34×1) | | (15.75×1)+(15.75×1)+(13.34×1) | | |
| | Number of Revolutions | | r.p.m | 7440,6300,6300 | | 7440,7440,6300 | |
| | Motor Output×Number of Units | | kW | (3.3×1)+(2.8×1)+(2.8×1) | | (3.3×1)+(3.3×1)+(2.8×1) | |
| | Starting Method | | Soft start | | Soft start | | |
| Fan | Type | | Propellor fan | | Propellor fan | | |
| | Motor Output | kW | (0.35×1)+(0.35×1)+(0.35×1) | | (0.35×1)+(0.35×1)+(0.35×1) | | |
| | Airflow Rate | | m³/min | 110+95+95 | | 110+110+95 | |
| | Drive | | Direct drive | | Direct drive | | |
| Connecting Pipes | Liquid Pipe | | φ12.7 C1220T (Brazing connection) | | φ15.9 C1220T (Brazing connection) | | |
| | Gas Pipe | | φ28.6 C1220T (Brazing connection) | | φ28.6 C1220T (Brazing connection) | | |
| Mass (Weight) | | kg | 175+175+175 | | 175+175+175 | | |
| Safety Devices | | High pressure switch, fan driver overload protector, overcurrent relay, inverter overload protector | | High pressure switch, fan driver overload protector, overcurrent relay, inverter overload protector | | | |
| Defrost Method | | Deicer | | Deicer | | | |
| Capacity Control | | % | 8-100 | | 7-100 | | |
| Refrigerant | Refrigerant Name | | R-410A | | R-410A | | |
| | Charge | kg | 11.1+11.1+11.1 | | 11.1+11.1+11.1 | | |
| | Control | | Electronic expansion valve | | Electronic expansion valve | | |
| Refrigerator Oil | | Refer to the nameplate of compressor | | Refer to the nameplate of compressor | | | |
| Standard Accessories | | Installation manual, Operation manual, Connection pipes, Cramps | | Installation manual, Operation manual, Connection pipes, Cramps | | | |
| Drawing No. | | | | | | | |

Notes:

- ★1 Indoor temp. : 27°CDB, 19.0°CWB / outdoor temp. : 35°CDB / Equivalent piping length : 7.5m, level difference : 0m.
- ★2 Indoor temp. : 20°CDB / outdoor temp. : 7°CDB, 6°CWB / Equivalent piping length : 7.5m, level difference : 0m.

| Conversion Formulae |
|---------------------|
| kcal/h=kW×860 |
| Btu/h=kW×3412 |
| cfm=m³/min×35.3 |

| Model Name (Combination Unit) | | RQCQ540PY1 | |
|-------------------------------|------------------------------|---|--|
| Model Name (Independent Unit) | | RQYQ180PY1+RQYQ180PY1+RQYQ180PY1 | |
| ★1 Cooling Capacity | kcal / h | 46,400 | |
| | Btu / h | 184,200 | |
| | kW | 54.0 | |
| ★2 Heating Capacity | kcal / h | 51,600 | |
| | Btu / h | 204,700 | |
| | kW | 60.0 | |
| Casing Color | | Ivory White 5Y7.5/1 | |
| Dimensions: (H×W×D) | | mm | 1680×635×765+1680×635×765+1680×635×765 |
| Heat Exchanger | | Cross fin coil | |
| Comp. | Type | Hermetically sealed scroll type | |
| | Piston Displacement | m ³ /h | (15.75×1)+(15.75×1)+(15.75×1) |
| | Number of Revolutions | r.p.m | 7440, 7440, 7440 |
| | Motor Output×Number of Units | kW | (3.3×1)+(3.3×1)+(3.3×1) |
| | Starting Method | Soft start | |
| Fan | Type | Propellor fan | |
| | Motor Output | kW | (0.35×1)+(0.35×1)+(0.35×1) |
| | Airflow Rate | m ³ /min | 110+110+110 |
| | Drive | Direct drive | |
| Connecting Pipes | Liquid Pipe | φ15.9 C1220T (Brazing connection) | |
| | Gas Pipe | φ28.6 C1220T (Brazing connection) | |
| Mass (Weight) | kg | 175+175+175 | |
| Safety Devices | | High pressure switch, fan driver overload protector, overcurrent relay, inverter overload protector | |
| Defrost Method | | Deicer | |
| Capacity Control | % | 7-100 | |
| Refrigerant | Refrigerant Name | | R-410A |
| | Charge | kg | 11.1+11.1+11.1 |
| | Control | | Electronic expansion valve |
| Refrigerator Oil | | Refer to the nameplate of compressor | |
| Standard Accessories | | Installation manual, Operation manual, Connection pipes, Cramps | |
| Drawing No. | | | |

Notes:

- ★1 Indoor temp. : 27°CDB, 19.0°CWB / outdoor temp. : 35°CDB / Equivalent piping length : 7.5m, level difference : 0m.
★2 Indoor temp. : 20°CDB / outdoor temp. : 7°CDB, 6°CWB / Equivalent piping length : 7.5m, level difference : 0m.

| Conversion Formulae |
|------------------------------|
| kcal/h=kW×860 |
| Btu/h=kW×3412 |
| cfm=m ³ /min×35.3 |

Heat Recovery Series <RQCEQ-P>

| Model Name (Combination Unit) | | RQCEQ280PY1 | | RQCEQ360PY1 | | |
|-------------------------------|------------------------------|---|-----------------------------------|---|-----------------------------------|--|
| Model Name (Independent Unit) | | RQEQ140PY1+RQEQ140PY1 | | RQEQ180PY1+RQEQ180PY1 | | |
| ★1 Cooling Capacity | kcal / h | 24,000 | | 31,000 | | |
| | Btu / h | 95,600 | | 122,800 | | |
| | kW | 28.0 | | 36.0 | | |
| ★2 Heating Capacity | kcal / h | 27,600 | | 34,400 | | |
| | Btu / h | 109,200 | | 136,400 | | |
| | kW | 32.0 | | 40.0 | | |
| Casing Color | | Ivory White 5Y7.5/1 | | Ivory White 5Y7.5/1 | | |
| Dimensions: (HxWxD) | | mm | 1680x635x765+1680x635x765 | | 1680x635x765+1680x635x765 | |
| Heat Exchanger | | Cross fin coil | | Cross fin coil | | |
| Comp. | Type | | Hermetically sealed scroll type | | Hermetically sealed scroll type | |
| | Piston Displacement | m³/h | (13.34x1)+(13.34x1) | | (15.75x1)+(15.75x1) | |
| | Number of Revolutions | r.p.m | 6300, 6300 | | 7440,7440 | |
| | Motor OutputxNumber of Units | kW | (2.8x1)+(2.8x1) | | (3.3x1)+(3.3x1) | |
| | Starting Method | | Soft start | | Soft start | |
| Fan | Type | | Propellor fan | | Propellor fan | |
| | Motor Output | kW | (0.35x1)+(0.35x1) | | (0.35x1)+(0.35x1) | |
| | Airflow Rate | m³/min | 95+95 | | 110+110 | |
| | Drive | | Direct drive | | Direct drive | |
| Connecting Pipes | Liquid Pipe | | φ9.5 C1220T (Brazing connection) | | φ12.7 C1220T (Brazing connection) | |
| | Gas Pipe | | φ22.2 C1220T (Brazing connection) | | φ25.4 C1220T (Brazing connection) | |
| Mass (Weight) | | kg | 175+175 | | 175+175 | |
| Safety Devices | | High pressure switch, fan driver overload protector, overcurrent relay, inverter overload protector | | High pressure switch, fan driver overload protector, overcurrent relay, inverter overload protector | | |
| Defrost Method | | Deicer | | Deicer | | |
| Capacity Control | | % | 12-100 | | 10-100 | |
| Refrigerant | Refrigerant Name | | R-410A | | R-410A | |
| | Charge | kg | 10.3+10.3 | | 10.6+10.6 | |
| | Control | | Electronic expansion valve | | Electronic expansion valve | |
| Refrigerator Oil | | Refer to the nameplate of compressor | | Refer to the nameplate of compressor | | |
| Standard Accessories | | Installation manual, Operation manual, Connection pipes, Cramps | | Installation manual, Operation manual, Connection pipes, Cramps | | |
| Drawing No. | | | | | | |

Notes:

- ★1 Indoor temp. : 27°CDB, 19.0°CWB / outdoor temp. : 35°CDB / Equivalent piping length : 7.5m, level difference : 0m.
- ★2 Indoor temp. : 20°CDB / outdoor temp. : 7°CDB, 6°CWB / Equivalent piping length : 7.5m, level difference : 0m.

| Conversion Formulae |
|---------------------|
| kcal/h=kWx860 |
| Btu/h=kWx3412 |
| cfm=m³/minx35.3 |

| Model Name (Combination Unit) | | RQCEQ460PY1 | | RQCEQ500PY1 | | | |
|-------------------------------|------------------------------|---|--|---|--|-------------------------|--|
| Model Name (Independent Unit) | | RREQ180PY1+RREQ140PY1+RREQ140PY1 | | RREQ180PY1+RREQ180PY1+RREQ140PY1 | | | |
| ★1 Cooling Capacity | kcal / h | 38,700 | | 43,000 | | | |
| | Btu / h | 153,500 | | 170,600 | | | |
| | kW | 45.0 | | 50.0 | | | |
| ★2 Heating Capacity | kcal / h | 44,700 | | 48,200 | | | |
| | Btu / h | 177,400 | | 191,100 | | | |
| | kW | 52.0 | | 56.0 | | | |
| Casing Color | | Ivory White 5Y7.5/1 | | Ivory White 5Y7.5/1 | | | |
| Dimensions: (H×W×D) | | mm | 1680×635×765+1680×635×765+1680×635×765 | | 1680×635×765+1680×635×765+1680×635×765 | | |
| Heat Exchanger | | Cross fin coil | | Cross fin coil | | | |
| Comp. | Type | | Hermetically sealed scroll type | | Hermetically sealed scroll type | | |
| | Piston Displacement | m ³ /h | (15.75×1)+(13.34×1)+(13.34×1) | | (15.75×1)+(15.75×1)+(13.34×1) | | |
| | Number of Revolutions | | r.p.m | 7440, 6300, 6300 | | 7440, 7440, 6300 | |
| | Motor Output×Number of Units | | kW | (3.3×1)+(2.8×1)+(2.8×1) | | (3.3×1)+(3.3×1)+(2.8×1) | |
| | Starting Method | | Soft start | | Soft start | | |
| Fan | Type | | Propellor fan | | Propellor fan | | |
| | Motor Output | kW | (0.35×1)+(0.35×1)+(0.35×1) | | (0.35×1)+(0.35×1)+(0.35×1) | | |
| | Airflow Rate | m ³ /min | 110+95+95 | | 110+110+95 | | |
| | Drive | | Direct drive | | Direct drive | | |
| Connecting Pipes | Liquid Pipe | | φ12.7 C1220T (Brazing connection) | | φ15.9 C1220T (Brazing connection) | | |
| | Gas Pipe | | φ28.6 C1220T (Brazing connection) | | φ28.6 C1220T (Brazing connection) | | |
| Mass (Weight) | | kg | 175+175+175 | | 175+175+175 | | |
| Safety Devices | | High pressure switch, fan driver overload protector, overcurrent relay, inverter overload protector | | High pressure switch, fan driver overload protector, overcurrent relay, inverter overload protector | | | |
| Defrost Method | | Deicer | | Deicer | | | |
| Capacity Control | | % | 8-100 | | 7-100 | | |
| Refrigerant | Refrigerant Name | | R-410A | | R-410A | | |
| | Charge | kg | 10.6+10.3+10.3 | | 10.6+10.6+10.3 | | |
| | Control | | Electronic expansion valve | | Electronic expansion valve | | |
| Refrigerator Oil | | Refer to the nameplate of compressor | | Refer to the nameplate of compressor | | | |
| Standard Accessories | | Installation manual, Operation manual, Connection pipes, Cramps | | Installation manual, Operation manual, Connection pipes, Cramps | | | |
| Drawing No. | | | | | | | |

Notes:

- ★1 Indoor temp. : 27°CDB, 19.0°CWB / outdoor temp. : 35°CDB / Equivalent piping length : 7.5m, level difference : 0m.
★2 Indoor temp. : 20°CDB / outdoor temp. : 7°CDB, 6°CWB / Equivalent piping length : 7.5m, level difference : 0m.

| Conversion Formulae |
|------------------------------|
| kcal/h=kW×860 |
| Btu/h=kW×3412 |
| cfm=m ³ /min×35.3 |

| Model Name (Combination Unit) | | RQCEQ540PY1 | | RQCEQ636PY1 | | | |
|-------------------------------|------------------------------|---|--|---|--|-------------------------|--|
| Model Name (Independent Unit) | | RREQ180PY1+RREQ180PY1+RREQ180PY1 | | RREQ212PY1+RREQ212PY1+RREQ212PY1 | | | |
| ★1 Cooling Capacity | kcal / h | 46,400 | | 54,700 | | | |
| | Btu / h | 184,200 | | 217,000 | | | |
| | kW | 54.0 | | 63.6 | | | |
| ★2 Heating Capacity | kcal / h | 51,600 | | 57,800 | | | |
| | Btu / h | 204,700 | | 229,300 | | | |
| | kW | 60.0 | | 67.2 | | | |
| Casing Color | | Ivory White 5Y7.5/1 | | Ivory White 5Y7.5/1 | | | |
| Dimensions: (H×W×D) | | mm | 1680×635×765+1680×635×765+1680×635×765 | | 1680×635×765+1680×635×765+1680×635×765 | | |
| Heat Exchanger | | Cross fin coil | | Cross fin coil | | | |
| Comp. | Type | | Hermetically sealed scroll type | | Hermetically sealed scroll type | | |
| | Piston Displacement | m³/h | (15.75×1)+(15.75×1)+(15.75×1) | | (16.89×1)+(16.89×1)+(16.89×1) | | |
| | Number of Revolutions | | r.p.m | 7440, 7440, 7440 | | 7980, 7980, 7980 | |
| | Motor Output×Number of Units | | kW | (3.3×1)+(3.3×1)+(3.3×1) | | (3.6×1)+(3.6×1)+(3.6×1) | |
| | Starting Method | | Soft start | | Soft start | | |
| Fan | Type | | Propellor fan | | Propellor fan | | |
| | Motor Output | kW | (0.35×1)+(0.35×1)+(0.35×1) | | (0.35×1)+(0.35×1)+(0.35×1) | | |
| | Airflow Rate | | m³/min | 110+110+110 | | 110+110+110 | |
| | Drive | | Direct drive | | Direct drive | | |
| Connecting Pipes | Liquid Pipe | | φ15.9 C1220T (Brazing connection) | | φ15.9 C1220T (Brazing connection) | | |
| | Gas Pipe | | φ28.6 C1220T (Brazing connection) | | φ28.6 C1220T (Brazing connection) | | |
| Mass (Weight) | | kg | 175+175+175 | | 179+179+179 | | |
| Safety Devices | | High pressure switch, fan driver overload protector, overcurrent relay, inverter overload protector | | High pressure switch, fan driver overload protector, overcurrent relay, inverter overload protector | | | |
| Defrost Method | | Deicer | | Deicer | | | |
| Capacity Control | | % | 7-100 | | 7-100 | | |
| Refrigerant | Refrigerant Name | | R-410A | | R-410A | | |
| | Charge | kg | 10.6+10.6+10.6 | | 11.2+11.2+11.2 | | |
| | Control | | Electronic expansion valve | | Electronic expansion valve | | |
| Refrigerator Oil | | Refer to the nameplate of compressor | | Refer to the nameplate of compressor | | | |
| Standard Accessories | | Installation manual, Operation manual, Connection pipes, Cramps | | Installation manual, Operation manual, Connection pipes, Cramps | | | |
| Drawing No. | | | | | | | |

Notes:

- ★1 Indoor temp. : 27°CDB, 19.0°CWB / outdoor temp. : 35°CDB / Equivalent piping length : 7.5m, level difference : 0m.
- ★2 Indoor temp. : 20°CDB / outdoor temp. : 7°CDB, 6°CWB / Equivalent piping length : 7.5m, level difference : 0m.

| Conversion Formulae |
|---------------------|
| kcal/h=kW×860 |
| Btu/h=kW×3412 |
| cfm=m³/min×35.3 |

| Model Name (Combination Unit) | | RQCEQ712PY1 | | RQCEQ744PY1 | | | |
|-------------------------------|------------------------------|---|---|---|---|---------------------------------|--|
| Model Name (Independent Unit) | | RREQ212PY1+RREQ180PY1+RREQ180PY1+RREQ140PY1 | | RREQ212PY1+RREQ212PY1+RREQ180PY1+RREQ140PY1 | | | |
| ★1 Cooling Capacity | kcal / h | 61,200 | | 64,000 | | | |
| | Btu / h | 242,900 | | 253,900 | | | |
| | kW | 71.2 | | 74.4 | | | |
| ★2 Heating Capacity | kcal / h | 67,400 | | 69,500 | | | |
| | Btu / h | 267,500 | | 275,700 | | | |
| | kW | 78.4 | | 80.8 | | | |
| Casing Color | | Ivory White 5Y7.5/1 | | Ivory White 5Y7.5/1 | | | |
| Dimensions: (H×W×D) | | mm | 1680×635×765+1680×635×765+1680×635×765+1680×635×765 | | 1680×635×765+1680×635×765+1680×635×765+1680×635×765 | | |
| Heat Exchanger | | Cross fin coil | | Cross fin coil | | | |
| Comp. | Type | | Hermetically sealed scroll type | | Hermetically sealed scroll type | | |
| | Piston Displacement | m ³ /h | (16.89×1)+(15.75×1)+(15.75×1)+(13.34×1) | | (16.89×1)+(16.89×1)+(15.75×1)+(13.34×1) | | |
| | Number of Revolutions | | r.p.m | 7980, 7440, 7440, 6300 | | 7980, 7980, 7440, 6300 | |
| | Motor Output×Number of Units | | kW | (3.6×1)+(3.3×1)+(3.3×1)+(2.8×1) | | (3.6×1)+(3.6×1)+(3.3×1)+(2.8×1) | |
| | Starting Method | | Soft start | | Soft start | | |
| Fan | Type | | Propellor fan | | Propellor fan | | |
| | Motor Output | kW | (0.35×1)+(0.35×1)+(0.35×1)+(0.35×1) | | (0.35×1)+(0.35×1)+(0.35×1)+(0.35×1) | | |
| | Airflow Rate | | m ³ /min | 110+110+110+95 | | 110+110+110+95 | |
| | Drive | | Direct drive | | Direct drive | | |
| Connecting Pipes | Liquid Pipe | | φ15.9 C1220T (Brazing connection) | | φ19.1 C1220T (Brazing connection) | | |
| | Gas Pipe | | φ28.6 C1220T (Brazing connection) | | φ31.8 C1220T (Brazing connection) | | |
| Mass (Weight) | | kg | 179+175+175+175 | | 179+179+175+175 | | |
| Safety Devices | | High pressure switch, fan driver overload protector, overcurrent relay, inverter overload protector | | High pressure switch, fan driver overload protector, overcurrent relay, inverter overload protector | | | |
| Defrost Method | | Deicer | | Deicer | | | |
| Capacity Control | | % | 5-100 | | 5-100 | | |
| Refrigerant | Refrigerant Name | | R-410A | | R-410A | | |
| | Charge | kg | 11.2+10.6+10.6+10.3 | | 11.2+11.2+10.6+10.3 | | |
| | Control | | Electronic expansion valve | | Electronic expansion valve | | |
| Refrigerator Oil | | Refer to the nameplate of compressor | | Refer to the nameplate of compressor | | | |
| Standard Accessories | | Installation manual, Operation manual, Connection pipes, Cramps | | Installation manual, Operation manual, Connection pipes, Cramps | | | |
| Drawing No. | | | | | | | |

Notes:

- ★1 Indoor temp. : 27°CDB, 19.0°CWB / outdoor temp. : 35°CDB / Equivalent piping length : 7.5m, level difference : 0m.
★2 Indoor temp. : 20°CDB / outdoor temp. : 7°CDB, 6°CWB / Equivalent piping length : 7.5m, level difference : 0m.

| Conversion Formulae |
|------------------------------|
| kcal/h=kW×860 |
| Btu/h=kW×3412 |
| cfm=m ³ /min×35.3 |

| Model Name (Combination Unit) | | RQCEQ816PY1 | | RQCEQ848PY1 | | | |
|-------------------------------|------------------------------|---|---|---|---|---------------------------------|--|
| Model Name (Independent Unit) | | RREQ212PY1+RREQ212PY1+RREQ212PY1+RREQ180PY1 | | RREQ212PY1+RREQ212PY1+RREQ212PY1+RREQ212PY1 | | | |
| ★1 Cooling Capacity | kcal / h | 70,200 | | 72,900 | | | |
| | Btu / h | 278,400 | | 289,300 | | | |
| | kW | 81.6 | | 84.8 | | | |
| ★2 Heating Capacity | kcal / h | 75,000 | | 77,100 | | | |
| | Btu / h | 297,600 | | 305,700 | | | |
| | kW | 87.2 | | 89.6 | | | |
| Casing Color | | Ivory White 5Y7.5/1 | | Ivory White 5Y7.5/1 | | | |
| Dimensions: (H×W×D) | | mm | 1680×635×765+1680×635×765+1680×635×765+1680×635×765 | | 1680×635×765+1680×635×765+1680×635×765+1680×635×765 | | |
| Heat Exchanger | | Cross fin coil | | Cross fin coil | | | |
| Comp. | Type | | Hermetically sealed scroll type | | Hermetically sealed scroll type | | |
| | Piston Displacement | m³/h | (16.89×1)+(16.89×1)+(16.89×1)+(15.75×1) | | (16.89×1)+(16.89×1)+(16.89×1)+(16.89×1) | | |
| | Number of Revolutions | | r.p.m | 7980, 7980, 7980, 7440 | | 7980, 7980, 7980, 7980 | |
| | Motor Output×Number of Units | | kW | (3.6×1)+(3.6×1)+(3.6×1)+(3.3×1) | | (3.6×1)+(3.6×1)+(3.6×1)+(3.6×1) | |
| | Starting Method | | Soft start | | Soft start | | |
| Fan | Type | | Propellor fan | | Propellor fan | | |
| | Motor Output | kW | (0.35×1)+(0.35×1)+(0.35×1)+(0.35×1) | | (0.35×1)+(0.35×1)+(0.35×1)+(0.35×1) | | |
| | Airflow Rate | | m³/min | 110+110+110+110 | | 110+110+110+110 | |
| | Drive | | Direct drive | | Direct drive | | |
| Connecting Pipes | Liquid Pipe | | φ19.1 C1220T (Brazing connection) | | φ19.1 C1220T (Brazing connection) | | |
| | Gas Pipe | | φ31.8 C1220T (Brazing connection) | | φ31.8 C1220T (Brazing connection) | | |
| Mass (Weight) | | kg | 179+179+179+175 | | 179+179+179+179 | | |
| Safety Devices | | High pressure switch, fan driver overload protector, overcurrent relay, inverter overload protector | | High pressure switch, fan driver overload protector, overcurrent relay, inverter overload protector | | | |
| Defrost Method | | Deicer | | Deicer | | | |
| Capacity Control | | % | 5-100 | | 5-100 | | |
| Refrigerant | Refrigerant Name | | R-410A | | R-410A | | |
| | Charge | kg | 11.2+11.2+11.2+10.6 | | 11.2+11.2+11.2+11.2 | | |
| | Control | | Electronic expansion valve | | Electronic expansion valve | | |
| Refrigerator Oil | | Refer to the nameplate of compressor | | Refer to the nameplate of compressor | | | |
| Standard Accessories | | Installation manual, Operation manual, Connection pipes, Cramps | | Installation manual, Operation manual, Connection pipes, Cramps | | | |
| Drawing No. | | | | | | | |

Notes:

- ★1 Indoor temp. : 27°CDB, 19.0°CWB / outdoor temp. : 35°CDB / Equivalent piping length : 7.5m, level difference : 0m.
- ★2 Indoor temp. : 20°CDB / outdoor temp. : 7°CDB, 6°CWB / Equivalent piping length : 7.5m, level difference : 0m.

| |
|---------------------|
| Conversion Formulae |
| kcal/h=kW×860 |
| Btu/h=kW×3412 |
| cfm=m³/min×35.3 |

1.2 BS Units

| Model | | BSVQ100PV1 | BSVQ160PV1 | BSVQ250PV1 | |
|---|--------------|---|---|---|---------------------------------------|
| Power Supply | | 1 Phase 50Hz 220 ~ 240V | 1 Phase 50Hz 220 ~ 240V | 1 Phase 50Hz 220 ~ 240V | |
| Casing | | Galvanized steel plate | Galvanized steel plate | Galvanized steel plate | |
| Dimensions: (HxWxD) | | mm | 207x388x326 | 207x388x326 | |
| Sound absorbing thermal insulation material | | Foamed polyurethane, Frame resisting needle felt | Foamed polyurethane, Frame resisting needle felt | Foamed polyurethane, Frame resisting needle felt | |
| Piping Connection | Indoor Unit | Liquid Pipes | 9.5mm C1220T (brazing connection) ★1 | 9.5mm C1220T (brazing connection) | 9.5mm C1220T (brazing connection) |
| | | Gas Pipes | 15.9mm C1220T (brazing connection) ★1 | 15.9mm C1220T (brazing connection) ★2 | 22.2mm C1220T (brazing connection) ★3 |
| | Outdoor Unit | Liquid Pipes | 9.5mm C1220T (brazing connection) | 9.5mm C1220T (brazing connection) | 9.5mm C1220T (brazing connection) |
| | | Suction Gas Pipes | 15.9mm C1220T (brazing connection) | 15.9mm C1220T (brazing connection) ★2 | 22.2mm C1220T (brazing connection) ★3 |
| | | HP/LP Gas Pipes | 12.7mm C1220T (brazing connection) | 12.7mm C1220T (brazing connection) ★2 | 19.1mm C1220T (brazing connection) ★3 |
| Weight | | kg | 14 | 14 | 15 |
| Standard Accessories | | Installation manual, Attached pipe, Insulation pipe cover, Clamps | Installation manual, Attached pipe, Insulation pipe cover, Clamps | Installation manual, Attached pipe, Insulation pipe cover, Clamps | |
| Drawing No. | | 4D057926 | 4D057927 | 4D057928 | |

- Note:**
- ★1 In case of connecting with a 20 ~ 50 type indoor unit, match to the size of field pipe using the attached pipe.
 - ★2 In case of connecting with indoor unit capacity index 150 or more and 160 or less, match to the size of field pipe using the attached pipe.
 - ★3 In case of connecting with a 200 type indoor unit or indoor capacity index more than 160 and less than 200, match to the size of field pipe using the attached pipe.
(Connection between the attached pipe and the field pipe must be brazed.)

| Model | | BSV4Q100PV1 | BSV6Q100PV1 | |
|---|--------------|--|--|---------------------------------------|
| Power Supply | | 1 Phase 50Hz 200-240V | 1 Phase 50Hz 200-240V | |
| Total capacity index of connectable indoor units | | 400 or less | 600 or less | |
| Capacity index of connectable indoor units per branch | | 100 or less | | |
| No. of Connectable Indoor Units | | Max. 20 | Max. 30 | |
| Casing | | Galvanized steel plate | Galvanized steel plate | |
| Dimensions: (HxWxD) | | mm | 209x1053x635 | 209x1577x635 |
| Sound Absorbing Thermal Insulation Material | | Foamed polyurethane, Flame resistant needle felt | Foamed polyurethane, Flame resistant needle felt | |
| Piping Connection | Indoor Unit | Liquid Pipes | 9.5mm C1220T (brazing connection) ★1 | 9.5mm C1220T (brazing connection) |
| | | Gas Pipes | 15.9mm C1220T (brazing connection) ★1 | 15.9mm C1220T (brazing connection) ★2 |
| | Outdoor Unit | Liquid Pipes | 12.7mm C1220T (brazing connection) | 15.9mm C1220T (brazing connection) |
| | | Suction Gas Pipes | 28.6mm C1220T (brazing connection) | 28.6mm C1220T (brazing connection) ★2 |
| | | HP/LP Gas Pipes | 19.1mm C1220T (brazing connection) | 28.6mm C1220T (brazing connection) ★2 |
| Weight | | kg | 60 | 89 |
| Standard Accessories | | Installation manual, Attached pipe Insulation pipe cover, Clamps | Installation manual, Attached pipe Insulation pipe cover, Clamps | |
| Drawing No. | | 4D064131A | 4D064132A | |

- Note:**
- ★1 When connecting with a 20 to 50 class indoor unit, connect to the attached pipe to the field pipe.
(Braze the connection between the attached and field pipe.)
 - ★2 When connecting with an indoor unit of 150 or more and 160 or less, connect to the attached pipe to the field pipe.
(Braze the connection between the attached and field pipe.)

Connection Range for BS Unit

| Components | Outdoor unit model name | Total capacity of connectable indoor units | Number of connectable indoor units |
|----------------------------|-------------------------|--|------------------------------------|
| Indoor unit total capacity | RQCEQ280PY1 | 14.0 to 36.4 (56.0) | 16 |
| | RQCEQ360PY1 | 18.0 to 46.2 (72.0) | 20 |
| | RQCEQ460PY1 | 23.0 to 59.8 (92.0) | 26 |
| | RQCEQ500PY1 | 25.0 to 65.0 (100.0) | 29 |
| | RQCEQ540PY1 | 27.0 to 70.2 (108.0) | 33 |
| | RQCEQ636PY1 | 31.8 to 82.7 (127.2) | 36 |
| | RQCEQ712PY1 | 35.6 to 92.6 (142.4) | 40 |
| | RQCEQ744PY1 | 37.2 to 96.7 (148.8) | 43 |
| | RQCEQ816PY1 | 40.8 to 106 (163.2) | 47 |
| | RQCEQ848PY1 | 42.4 to 110 (169.6) | 50 |

Note: ★ Values inside brackets are based on connection of indoor units rated at maximum capacity, 200% from single outdoor units, 160% from double outdoor units, 130% from triple outdoor units.

Part 3

Refrigerant Circuit

| | |
|--|----|
| 1. Refrigerant Circuit | 19 |
| 1.1 RQYQ140 · 180PY1, RQEQ140 ~ 212PY1 | 19 |
| 1.2 BS Unit | 21 |
| 2. Functional Parts Layout | 23 |
| 2.1 RQYQ140 · 180PY1, RQEQ140 ~ 212PY1..... | 23 |
| 3. Refrigerant Flow for Each Operation Mode..... | 24 |
| 3.1 RQYQ140 · 180PY1 | 24 |
| 3.2 RQCEQ280 ~ 848PY1 | 27 |

1. Refrigerant Circuit

1.1 RQYQ140 · 180PY1, RREQ140 ~ 212PY1

| No. in refrigerant system diagram | Symbol | Name | Major Function |
|-----------------------------------|--------|--|--|
| (1) | M1C | Inverter compressor (INV.) | Inverter compressor is operated on frequencies 52Hz to 210Hz (180 class: 248Hz, 212 class: 266Hz) by using the inverter. The number of operating steps is 20. (180 class: 23 steps, 212 class: 27 steps) |
| (2) | M1F | Inverter fan | Because the system is an air heat exchange type, the fan is operated 8-step rotation speed by using the inverter. |
| (3) | Y1E | Electronic expansion valve (Main) | While in heating operation, PI control is applied to keep the outlet superheated degree of air heat exchanger constant. |
| (4) | Y2E | Electronic expansion valve (Refrigerant charge) | This is used to charge refrigerant and discharge refrigerant from the refrigerant regulator. |
| (5) | Y3E | Electronic expansion valve (Subcooling) | PI control is applied to keep the outlet superheated degree of subcooling heat exchanger constant. |
| (6) | Y1S | Solenoid valve (Refrigerant regulator hot gas) | Used to charge refrigerant and discharge refrigerant from the refrigerant regulator. |
| (7) | Y2S | Solenoid valve (Refrigerant regulator liquid pipe) | Used to collect refrigerant to the refrigerant regulator. |
| (8) | Y3S | Solenoid valve (Refrigerant regulator gas vent pipe) | Used to collect refrigerant to the refrigerant regulator. |
| (9) | Y4S | Solenoid valve (Hot gas) | Used to prevent the low pressure from transient falling. |
| (10) | Y5S | Solenoid valve (Circuit of oil return) | Used to adjust the amount of oil in the mixing unit. |
| (11) | Y6S | Four way valve (Heat exchanger) | Used to switch the operation mode between cooling and heating. |
| (12) | Y7S | Four way valve (Dual pressure gas pipe) | Used to switch dual pressure gas pipe to high pressure or low pressure. |
| (13) | Y8S | Four way valve (Mixing unit) | Use to adjust the amount of refrigeration oil and clean pipes during check operation. |
| (14) | Y9S | Solenoid valve (Mixing unit inlet) | Use to adjust the amount of refrigeration oil and clean pipes during check operation. Use to prevent refrigerant from flowing into the mixing unit during normal operation. |
| (15) | R1T | Thermistor (Outdoor air: Ta) | Used to detect outdoor temperature, correct discharge pipe temperature and others. |
| (16) | R2T | Thermistor (Discharge pipe) | Used to detect discharge pipe temperature. Used for compressor temperature protection control. |
| (17) | R3T | Thermistor (Heat exchanger liquid pipe) | This detects temperature of liquid pipe between the air heat exchanger and main electronic expansion valve. Used to make judgements on the recover or discharge refrigerants to the refrigerant regulator. |
| (18) | R4T | Thermistor (Heat exchanger gas pipe) | This detects temperature of gas pipe for air heat exchanger. Used to exercise the constant control of superheated degree when an evaporator is used for outdoor unit heat exchanging. |
| (19) | R5T | Thermistor (Suction pipe) | Used to detect suction pipe temperature. |
| (20) | R6T | Thermistor (Heat exchanger deicer) | Used to detect liquid pipe temperature of air heat exchanger. Used to make judgements on defrosting operation. |
| (21) | R7T | Thermistor (Subcooling heat exchanger gas pipe) | This detects temperature of gas pipe on the evaporation side of subcooling heat exchanger. Used to exercise the constant control of superheated degree at the outlet of subcooled heat exchanger. |
| (22) | R8T | Thermistor (Subcooling heat exchanger liquid pipe) | This detects temperature of liquid pipe between the main electronic expansion valve and subcooling heat exchanger. |
| (23) | R9T | Thermistor (Liquid pipe) | This detects temperature of liquid pipe. |
| (25) | S1NPH | High pressure sensor | Used to detect high pressure. |
| (26) | S1NPL | Low pressure sensor | Used to detect low pressure. |
| (27) | S1PH | High pressure switch (For INV.) | In order to prevent the increase of high pressure when a malfunction occurs, this switch is activated at high pressure of 4.0 MPa or more to stop the compressor operation. |
| (28) | — | Pressure regulating valve (Liquid pipe) | Open at 3.3 MPa or more to avoid pressure increase to prevent damage to functional parts by the pressure increase and to protect the field piping during transportation, storage and operation of the equipment. |
| (29) | — | Subcooling heat exchanger | Apply subcooling to liquid refrigerant. |
| (30) | — | Capillary tube | Used to return the refrigerating oil separated through the oil separator to the INV. compressor. |

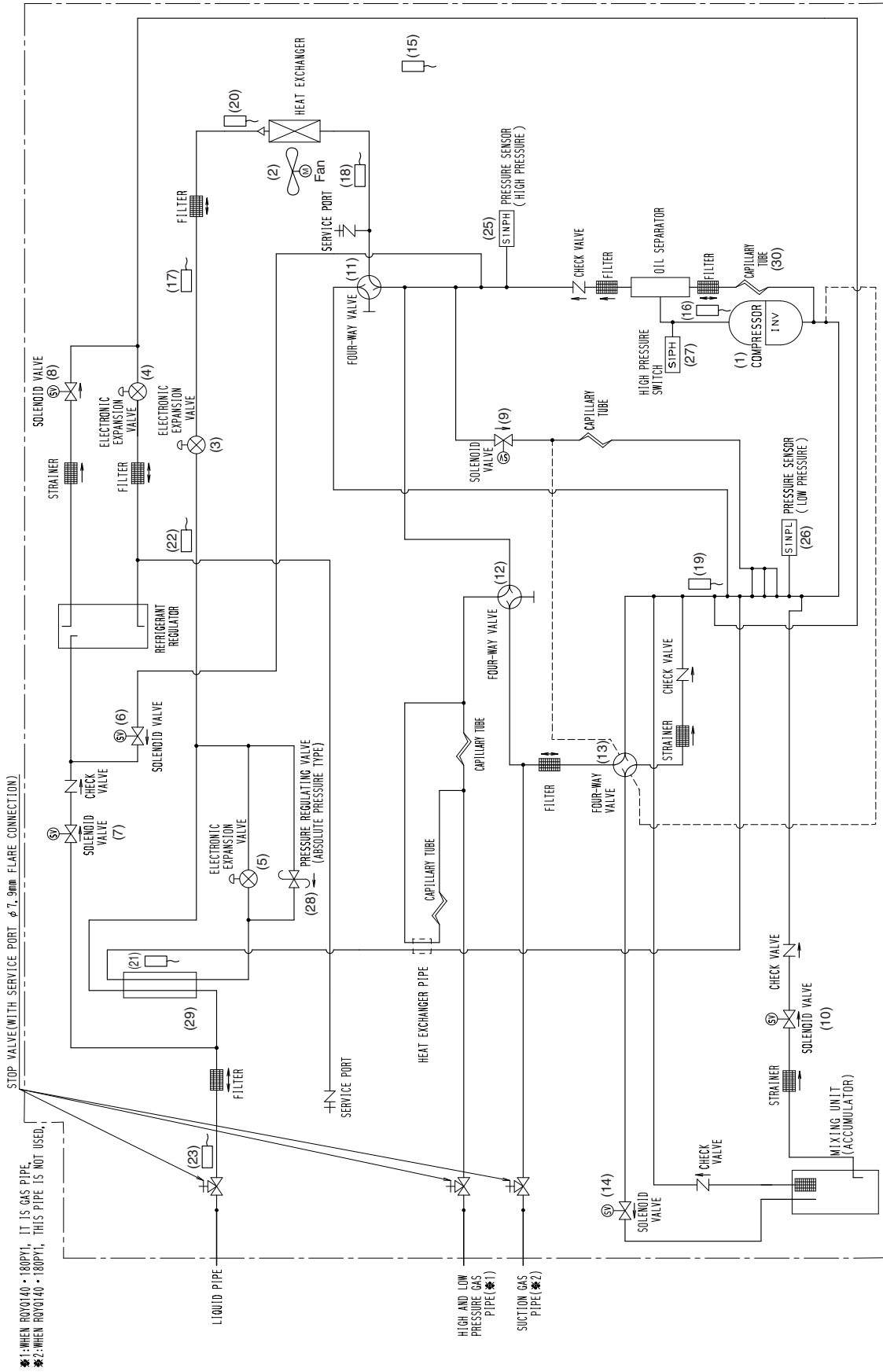

1.2 BS Unit

| No. | Name | Symbol | Function |
|-----|-----------------------------------|--------|---|
| 1 | Electronic expansion valve (EVSC) | Y1E | In simultaneous cooling and heating operation, it is used to subcooling liquid refrigerants when an indoor unit downstream of this BS unit is in heating operation. |
| 2 | Electronic expansion valve (EVHS) | Y2E | Opens while in heating operation or all indoor units are in cooling operation. |
| 3 | Electronic expansion valve (EVLS) | Y3E | Opens while in cooling operation. |
| 4 | Electronic expansion valve (EVH) | Y4E | Opens while in heating operation or all indoor units are in cooling operation. |
| 5 | Electronic expansion valve (EVL) | Y5E | Opens while in cooling operation. |
| 6 | Capillary tube | — | Used to bypass high pressure gas to low pressure side to protect “Refrigerant accumulation” in high and low pressure gas pipes. |
| 7 | Double pipe heat exchanger | — | In simultaneous cooling and heating operation, it is used to subcooling liquid refrigerants when an indoor unit downstream of this BS unit is in heating operation. |

• BSVQ100 ~ 250PV1

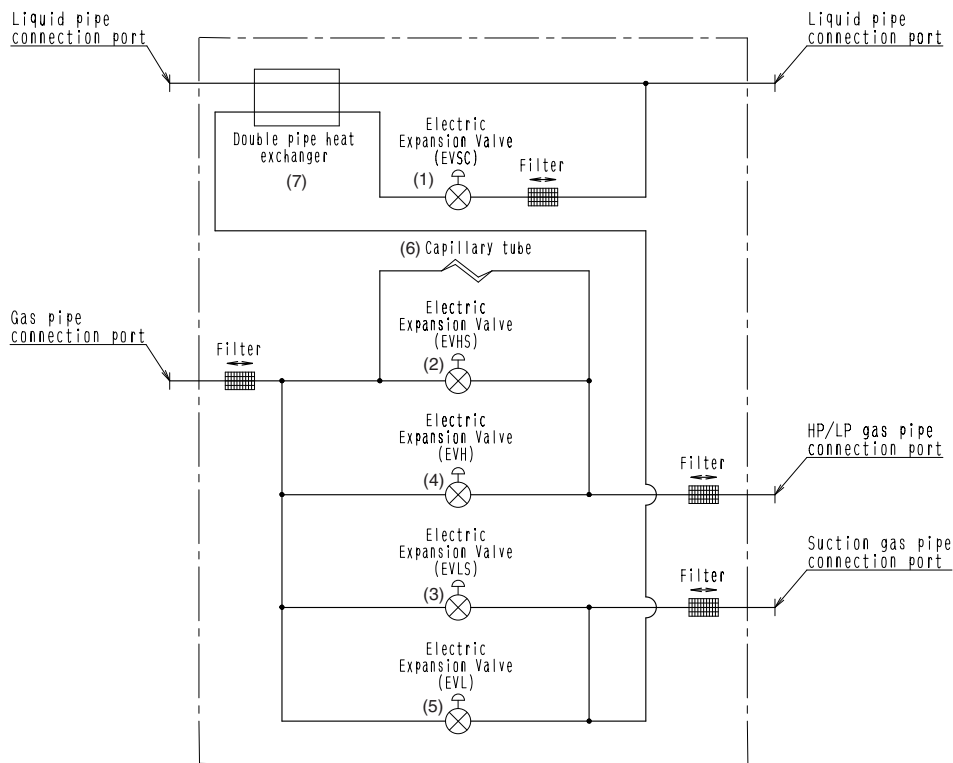

4D057985B

• BSV4Q100PV1

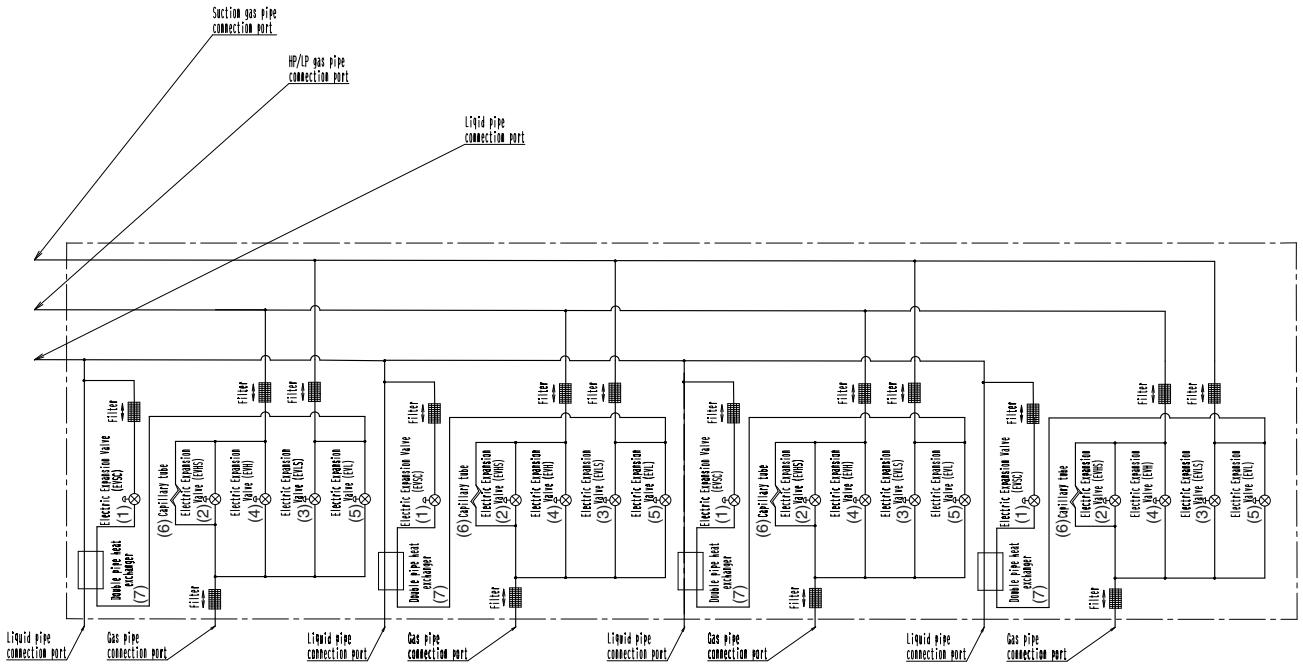

3D064148

• BSV6Q100PV1

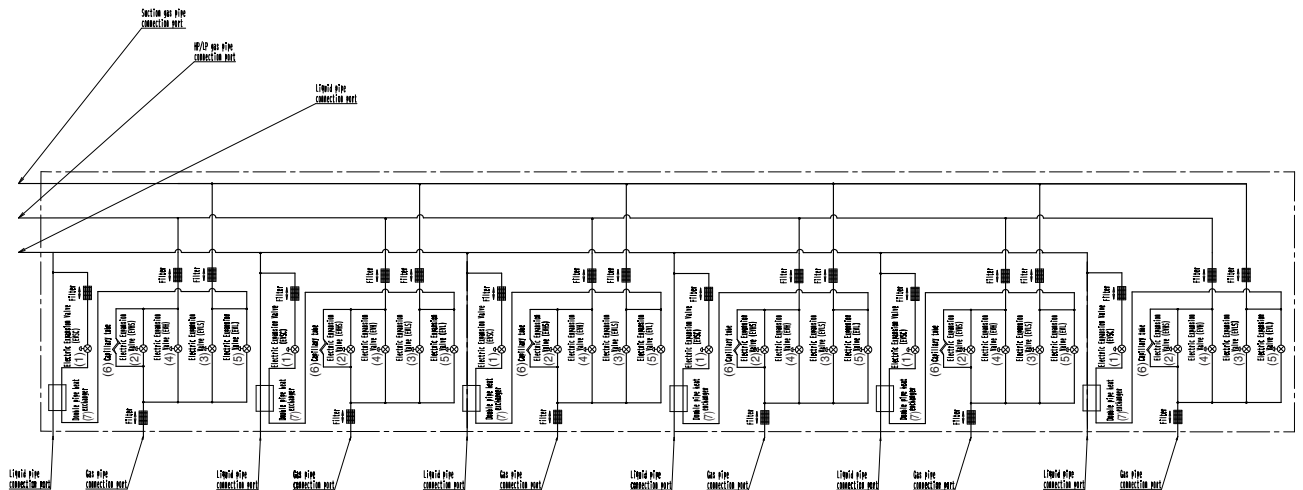

3D064149

2. Functional Parts Layout

2.1 RQYQ140 · 180PY1, RQE140 ~ 212PY1

Plan

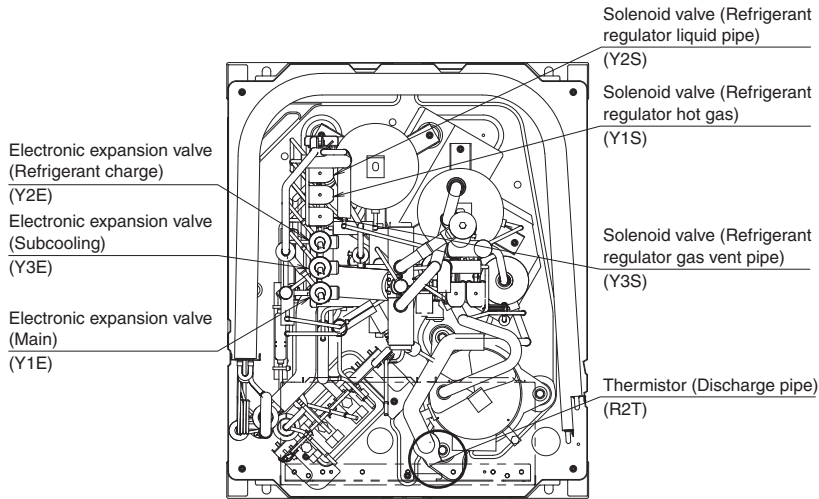

Front View

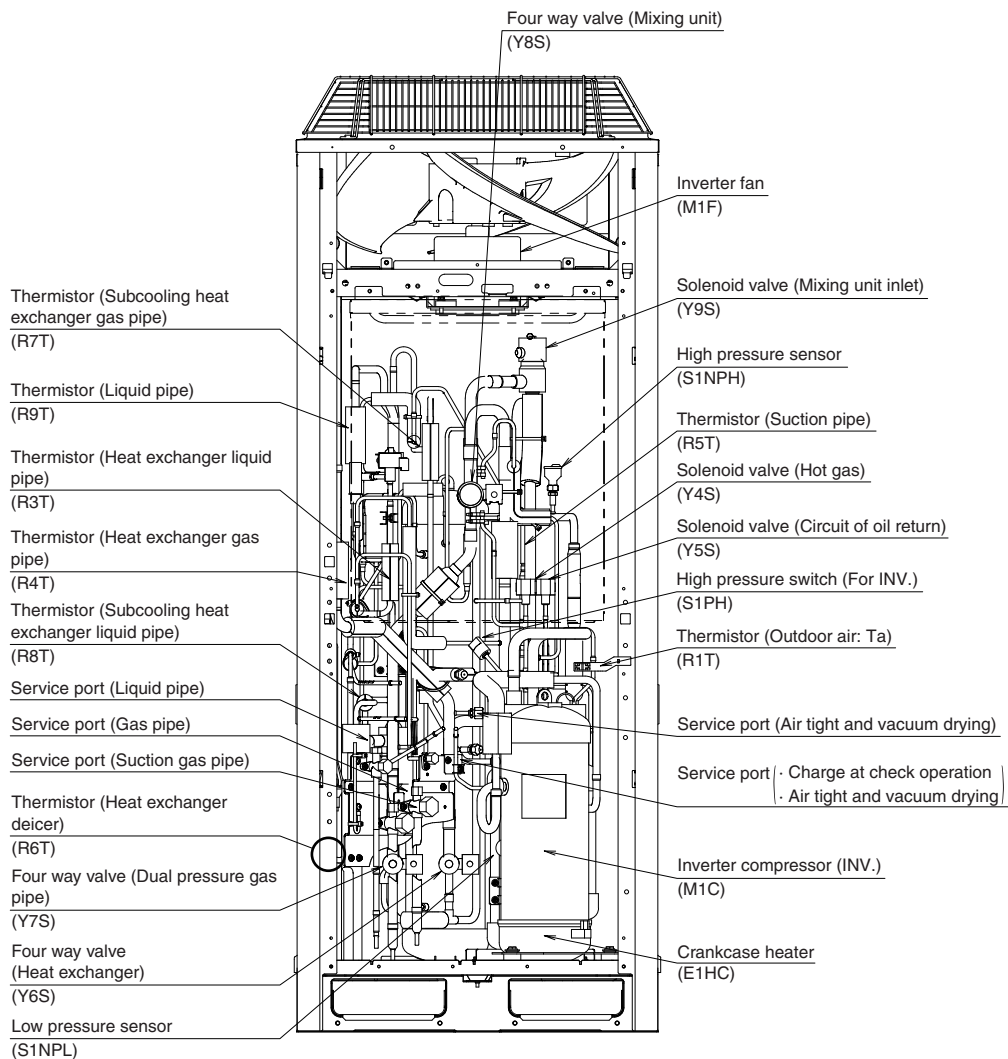

3. Refrigerant Flow for Each Operation Mode

3.1 RQYQ140 · 180PY1

Cooling operation

- "High temperature, high pressure gas"
- "High temperature, high pressure liquid"
- "Low temperature, low pressure"

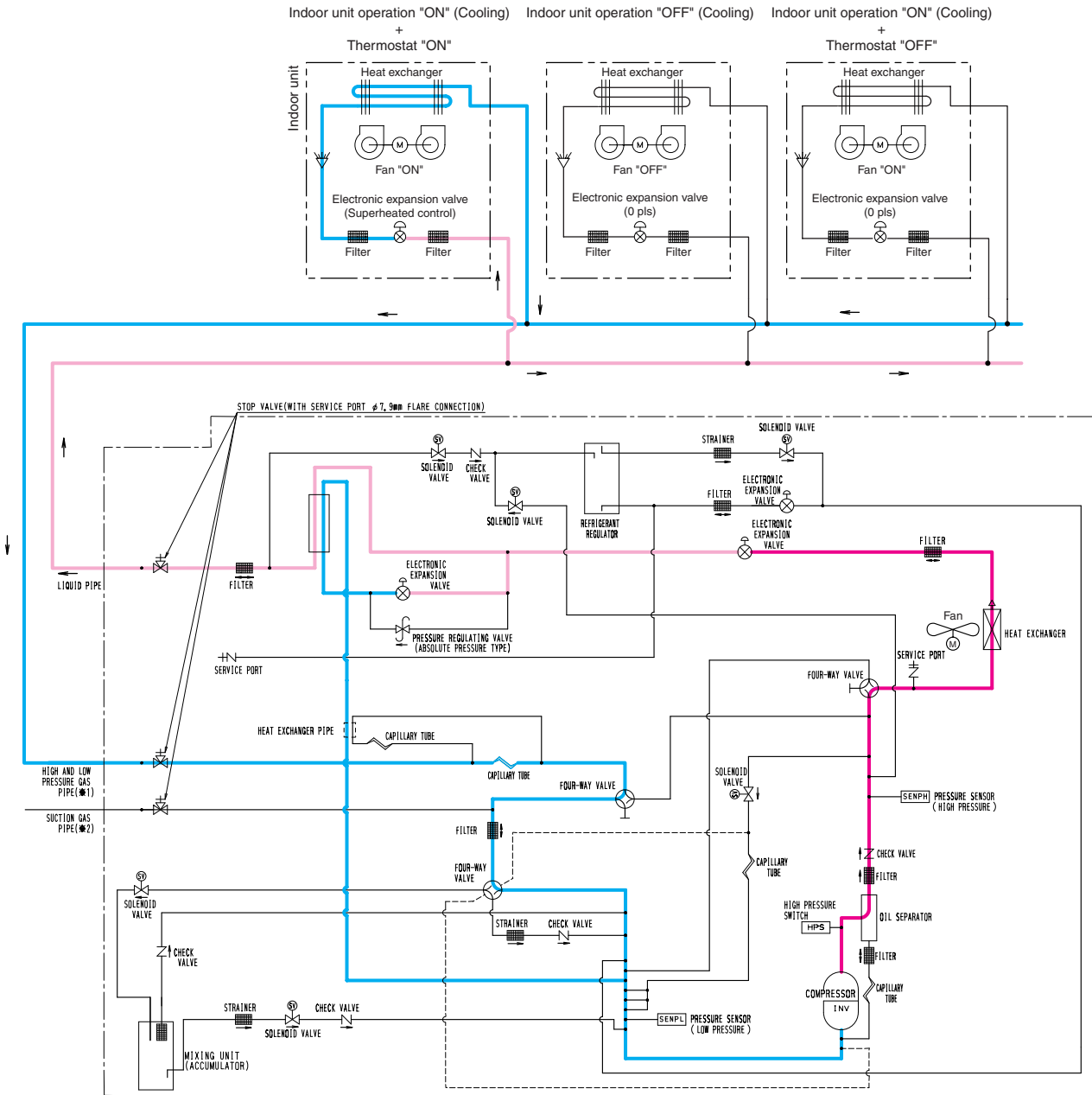

*1: WHEN RQYQ140 · 180PY1, IT IS GAS PIPE.
 *2: WHEN RQYQ140 · 180PY1, THIS PIPE IS NOT USED.

Cooling oil return / Heating oil return / Defrost operation

- "High temperature, high pressure gas"
- "High temperature, high pressure liquid"
- "Low temperature, low pressure"

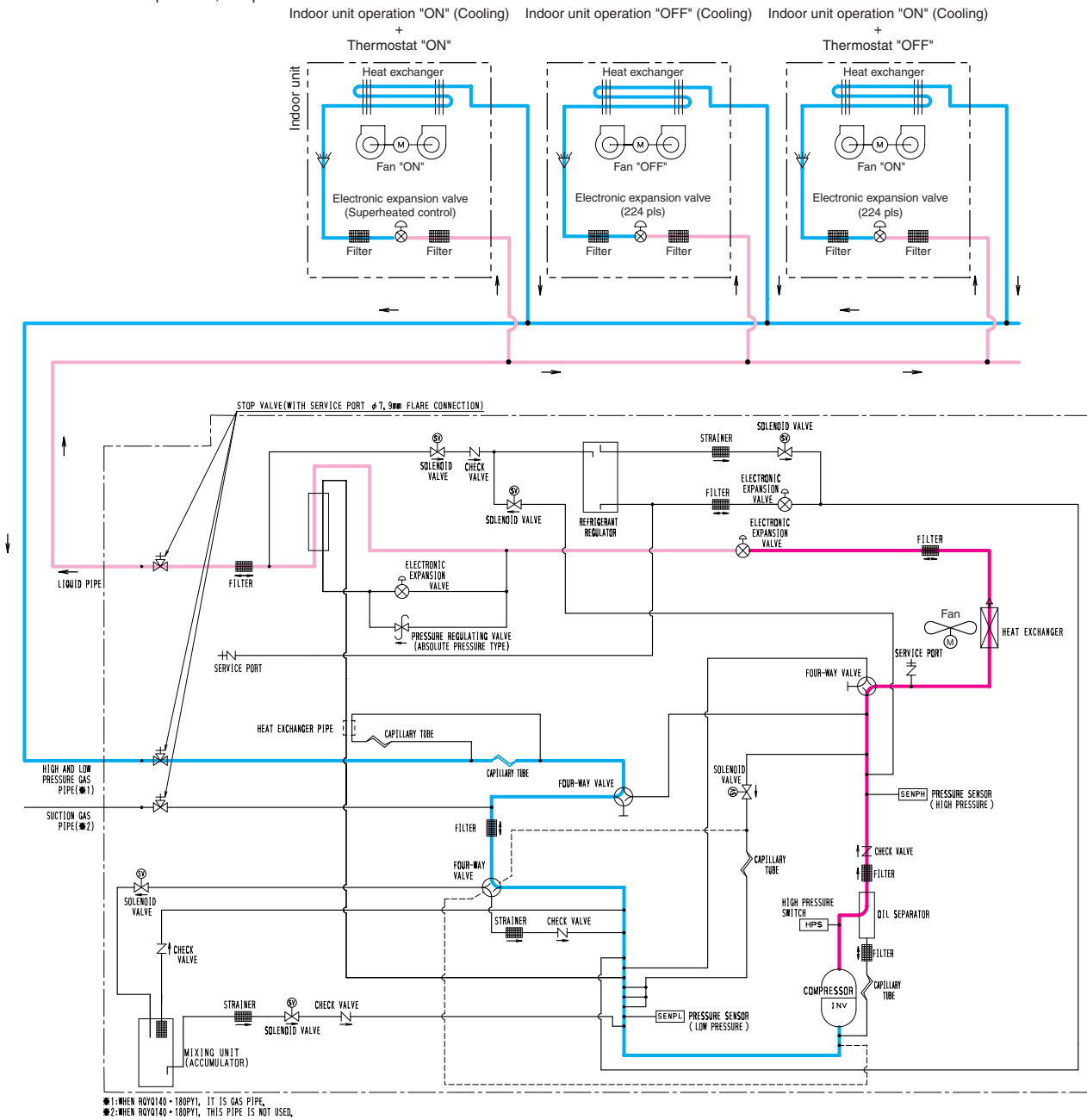

3.2 RQCEQ280 ~ 848PY1

Cooling operation

- "High temperature, high pressure gas"
- "High temperature, high pressure liquid"
- "Low temperature, low pressure"

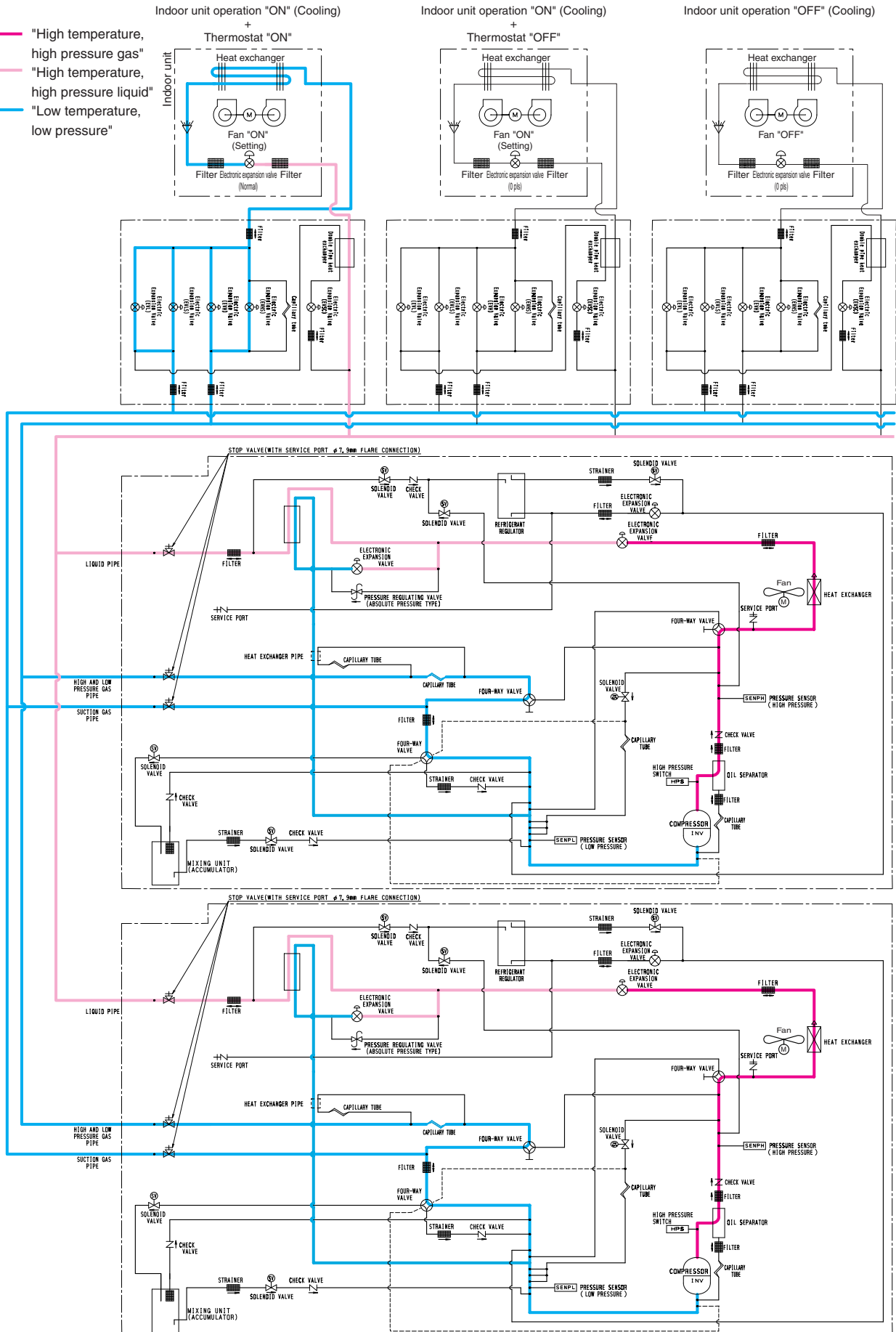

Cooling oil return operation

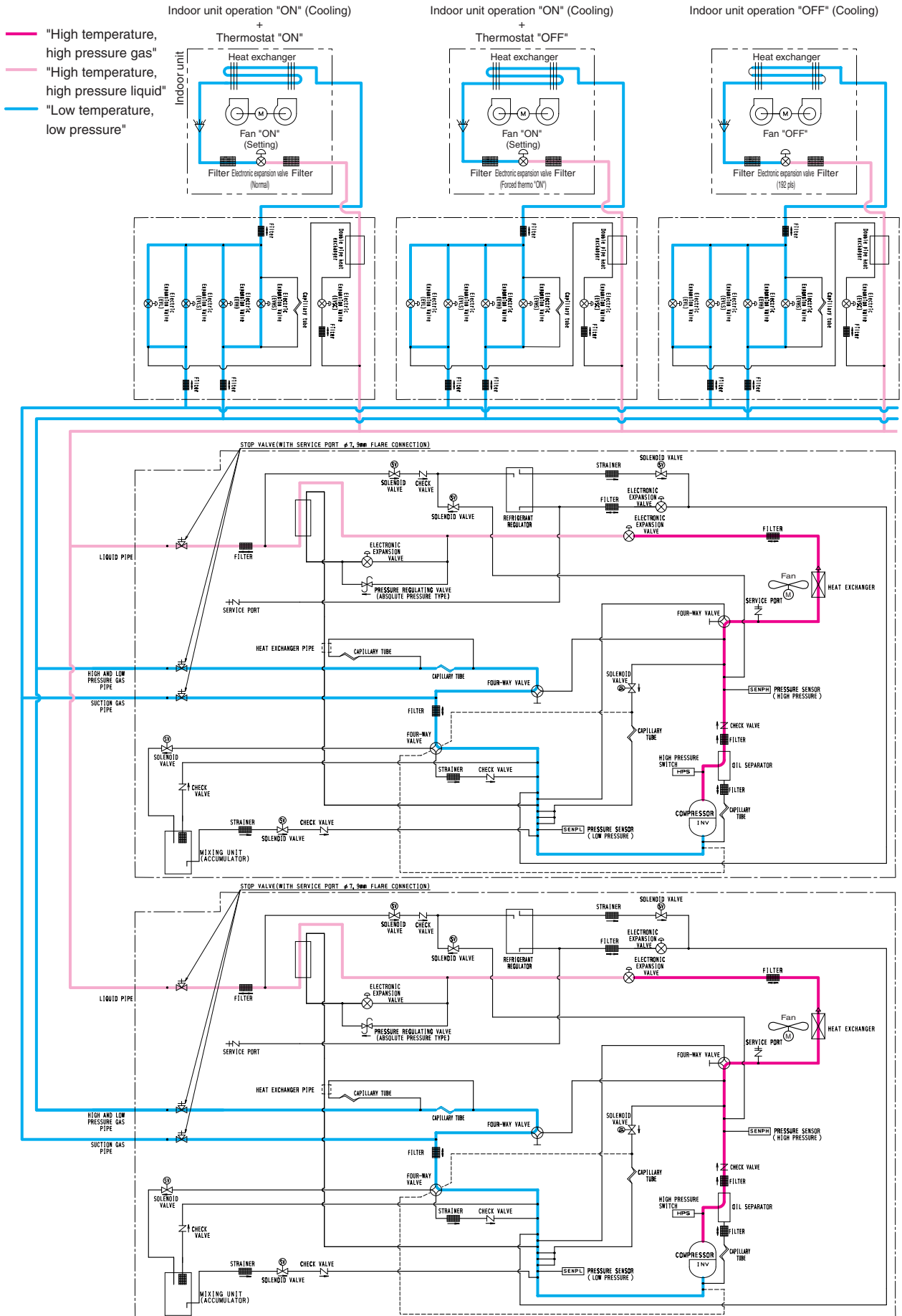

Heating operation

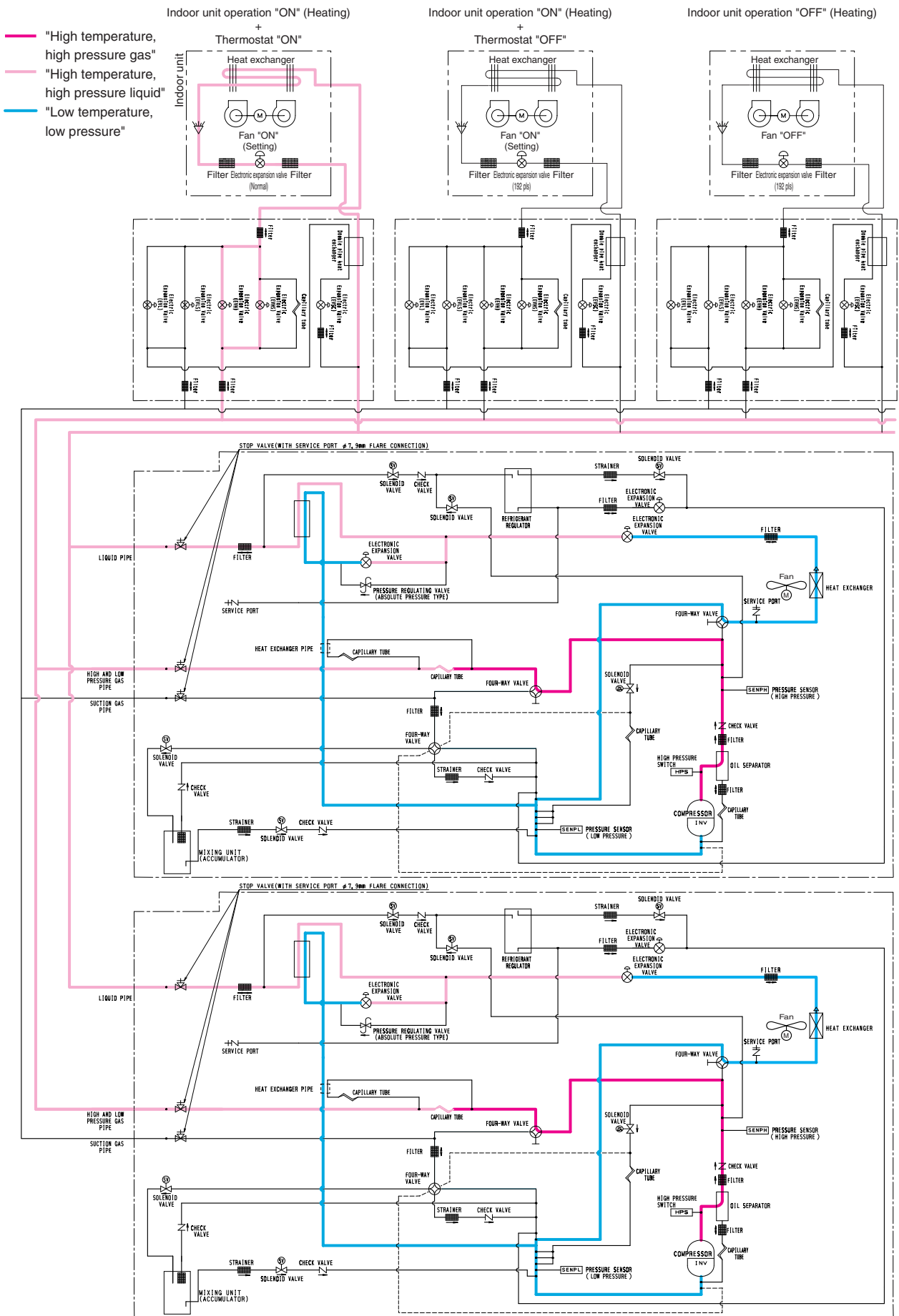

Heating oil return operation

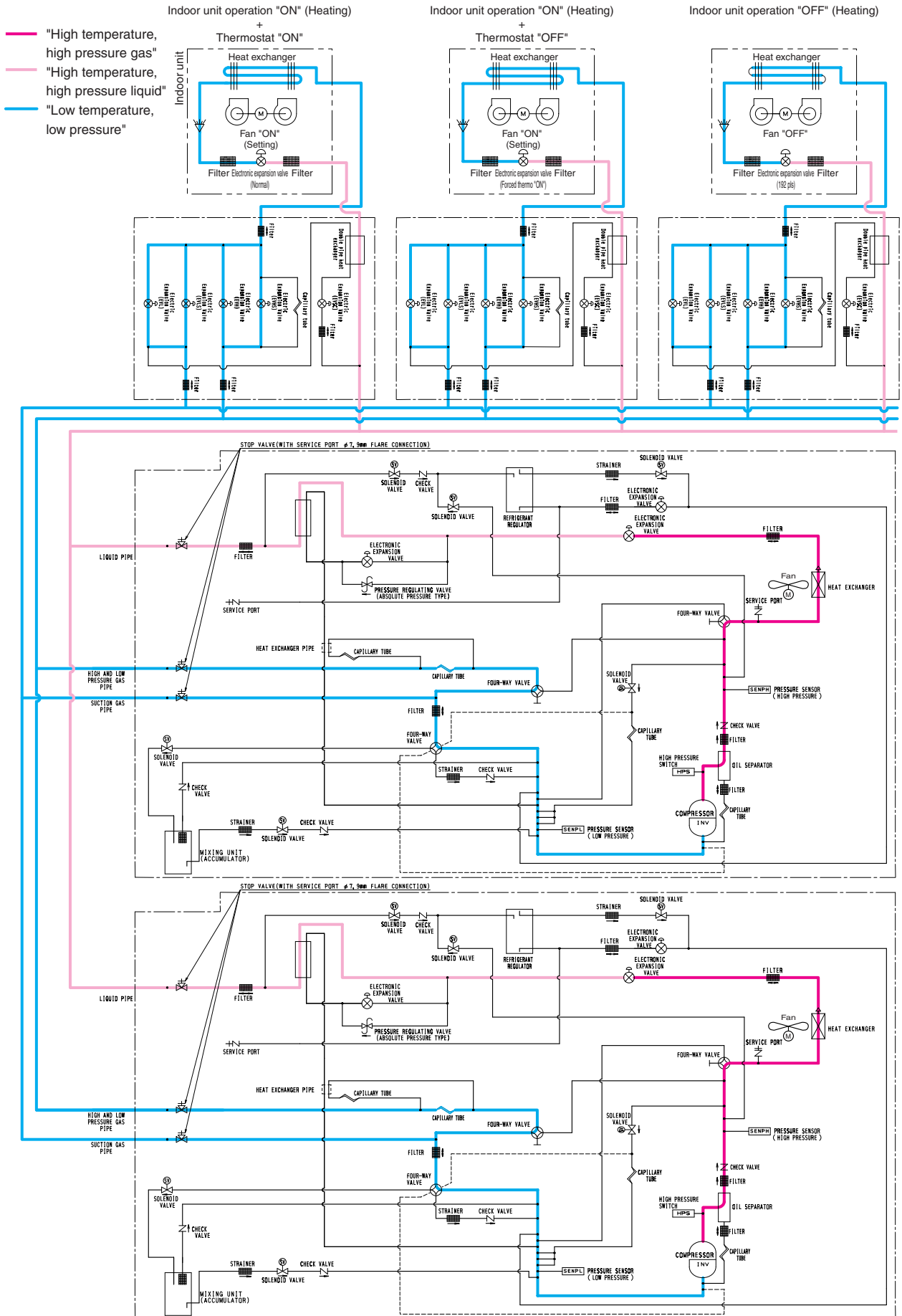

Part 4

Function

| | |
|------------------------------------|----|
| 1. Function General..... | 35 |
| 1.1 Operation Mode..... | 35 |
| 1.2 Symbol | 36 |
| 2. Detailed Control Functions..... | 37 |
| 2.1 Stop Operation | 37 |
| 2.2 Standby | 37 |
| 2.3 Rotation Control | 37 |
| 2.4 Startup Control | 38 |
| 2.5 Normal Operation | 39 |
| 2.6 Protection Control..... | 47 |
| 2.7 Special Control..... | 52 |

1.2 Symbol

| Symbol | Electric symbol | Description of function |
|--------|-----------------|--|
| 20SA | Y6S | Four way valve (Heat exchanger switch) |
| 20SB | Y7S | Four way valve (Dual pressure gas pipe switch) |
| | Y8S | Four way valve (Mixing unit) |
| DSH | — | Discharge pipe superheated degree |
| DSHi | — | Discharge pipe superheated degree of INV. compressor |
| DSHs | — | Discharge pipe superheated degree of STD compressor |
| EV | — | Opening of electronic expansion valve |
| EVJ | Y2E | Electronic expansion valve (Refrigerant charge) |
| EVM | Y1E | Electronic expansion valve (Main) |
| EVT | Y3E | Electronic expansion valve (Subcooling) |
| HTdi | — | Value of INV. compressor discharge pipe temperature compensated with outdoor air temperature |
| HTds | — | Value of STD compressor discharge pipe temperature compensated with outdoor air temperature |
| Pc | S1NPH | Value detected by high pressure sensor |
| Pe | S2NPL | Value detected by low pressure sensor |
| SH | — | Evaporator outlet superheated degree |
| SHS | — | Target evaporator outlet superheated degree |
| SVB | Y5S | Solenoid valve (Circuit of oil return) |
| SVG1 | Y1S | Solenoid valve (Refrigerant regulator hot gas) |
| SVG2 | Y3S | Solenoid valve (Refrigerant regulator gas vent pipe) |
| SVL | Y2S | Solenoid valve (Refrigerant regulator liquid pipe) |
| SVP | Y4S | Solenoid valve (Hot gas) |
| Ta | R1T | Outdoor air temperature |
| Tb | R4T | Heat exchanger outlet temperature at cooling |
| Tc | — | High pressure equivalent saturation temperature |
| TcS | — | Target temperature of Tc |
| Tdi | R31T | Discharge pipe temperature of INV. compressor |
| Tds | R32T, R33T | Discharge pipe temperature of STD compressor |
| Te | — | Low pressure equivalent saturation temperature |
| TeS | — | Target temperature of Te |
| Tf | R7T | Temperature of liquid pipe between outdoor unit heat exchanger and main electronic expansion valve |
| Tfin | R1T (A3P) | Inverter fin temperature |
| Tg | R4T | Heat exchanger gas pipe temperature |
| Tl | R6T | Temperature of liquid pipe between main electronic expansion valve and subcooling heat exchanger |
| TsA | R5T | Suction pipe temperature |
| Tsc | R9T | Temperature of liquid pipe |
| Tsh | R5T | Temperature of gas pipe detected with the subcooling heat exchanger outlet thermistor |

2. Detailed Control Functions

2.1 Stop Operation

2.1.1 Stop due to Malfunction

In order to protect compressors, if any of the abnormal state occurs, the system will make "stop with thermostat OFF" and the malfunction will be determined according to the number of retry times.

(Refer to "Malfunction code list" (P.107~) of the troubleshooting for the items to determine the malfunction.)

* Operation to determine the malfunction: "Stop the system" and "malfunction code" is displayed on the remote controller.

2.1.2 When System is in Stop Mode

Stop both the master and slave units.

The four way valves both for heat exchanger switch and piping switch retain the condition before they were stopped.

2.2 Standby

2.2.1 Restart Standby

Used to forcedly stop the compressor for a period of 3 minutes, in order to prevent the frequent ON/OFF of the compressor and equalize the pressure within the refrigerant system.

In addition, the outdoor fan carry out the residual operation for a while to suppress the acceleration of the pressure equalizing and melting of the refrigerant to the evaporator.

2.2.2 Crankcase Heater Control

In order to prevent the refrigerant from melting in the compressor oil in the stopped mode, this mode is used to control the crankcase heater.

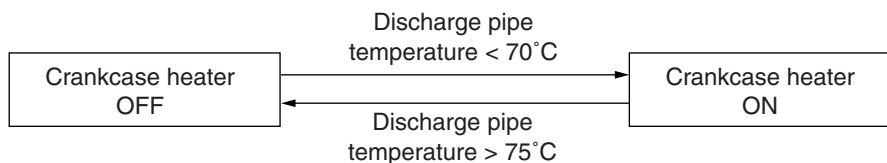

2.3 Rotation Control

2.3.1 Outdoor Unit Rotation

In the case of multi-outdoor-unit system, this outdoor unit rotation is used to prevent the compressor from burning out due to unbalanced oil level between outdoor units.

[Timing of outdoor unit rotation]

· At the beginning of startup control

<System with two outdoor units>

| | Outdoor Unit 1 | Outdoor Unit 2 |
|---------------|----------------|----------------|
| Previous time | Priority 1 | Priority 2 |
| This time | Priority 2 | Priority 1 |
| Next time | Priority 1 | Priority 2 |

<System with three outdoor units>

| | Outdoor Unit 1 | Outdoor Unit 2 | Outdoor Unit 3 |
|-------------------------|----------------|----------------|----------------|
| Previous time | Priority 1 | Priority 2 | Priority 3 |
| This time | Priority 3 | Priority 1 | Priority 2 |
| Next time | Priority 2 | Priority 3 | Priority 1 |
| One time after the next | Priority 1 | Priority 2 | Priority 3 |

<System with four outdoor units>

| | Outdoor Unit 1 | Outdoor Unit 2 | Outdoor Unit 3 | Outdoor Unit 3 |
|----------------------------------|----------------|----------------|----------------|----------------|
| Previous time | Priority 1 | Priority 2 | Priority 3 | Priority 4 |
| This time | Priority 4 | Priority 1 | Priority 2 | Priority 3 |
| Next time | Priority 3 | Priority 4 | Priority 1 | Priority 2 |
| One time after the next | Priority 2 | Priority 3 | Priority 4 | Priority 1 |
| One time after the next plus one | Priority 1 | Priority 2 | Priority 3 | Priority 4 |

2.4 Startup Control

This control is used to equalize the pressure in the front and back of the compressor prior to the startup of the compressor, thus reducing startup loads. Furthermore, the inverter is turned ON to charge the capacitor.

To avoid stresses to the compressor due to oil return or else after the startup, the following control is made and the position of the four way valve is also determined. Start both the master and the slave units simultaneously to position the four way valve.

(1) Startup Control in Cooling Operation

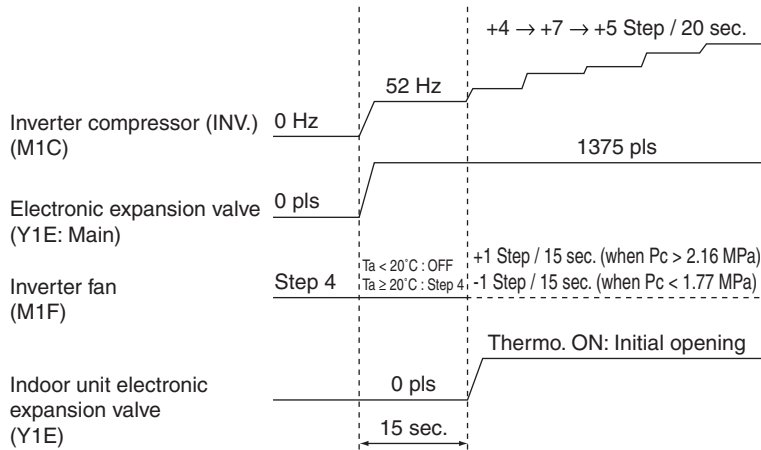

[Ending conditions]

- OR
- A lapse of 90 sec.
 - Tc (high pressure equivalent saturation temperature) > 48°C
 - Pc-Pe > 0.39MPa.

(2) Startup Control in Heating Operation (Outdoor unit heat exchanger = Evaporator)

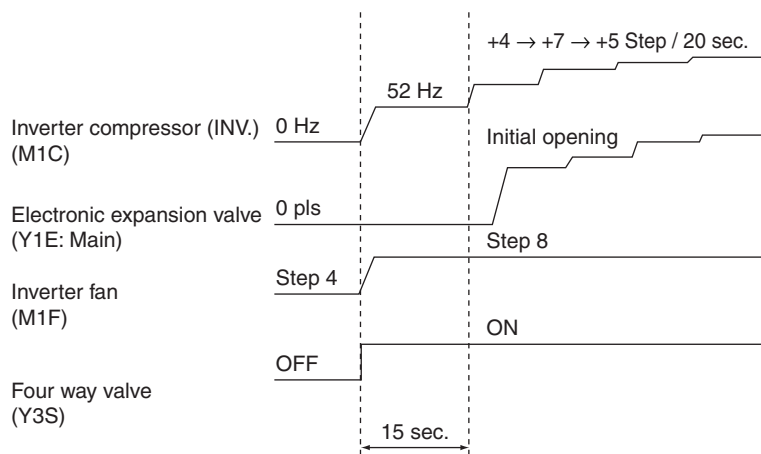

[Ending conditions]

- OR
- A lapse of 90 sec.
 - Pc-Pe > 0.39MPa.

(3) Startup Control in Heating Operation (Outdoor unit heat exchanger = Condenser)

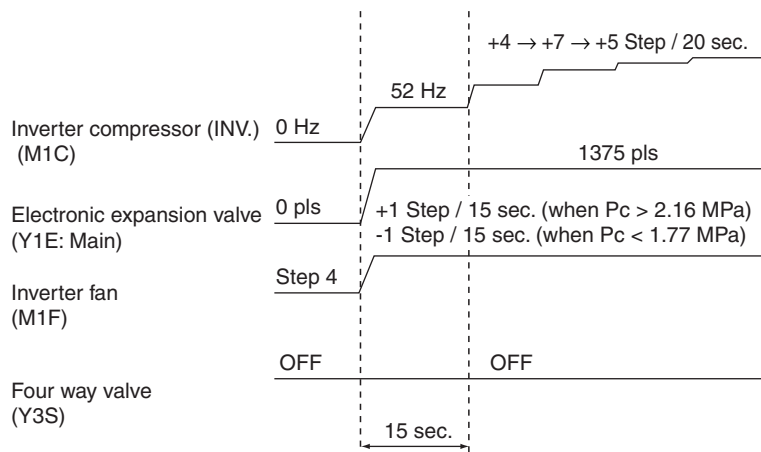

[Ending conditions]

- OR
- A lapse of 90 sec.
 - Pc-Pe > 0.39MPa.

2.5 Normal Operation

2.5.1 List of Functions in Normal Operation

<Outdoor Unit>

| Part Name | Electric Symbol | Normal Cooling | Normal Heating | Normal Simultaneous Cooling / Heating |
|--|-----------------|--|---|---|
| Compressor | M1C | PI control, High pressure protection, Low pressure protection, Td protection, INV protection | PI control, High pressure protection, Low pressure protection, Td protection, INV protection | PI control, High pressure protection, Low pressure protection, Td protection, INV protection |
| Outdoor unit fan | M1F | Cooling fan control | <ul style="list-style-type: none"> Outdoor unit heat exchanger: Condenser / Cooling fan control Outdoor unit heat exchanger: Evaporator / Fan step 7 or 8 | <ul style="list-style-type: none"> Outdoor unit heat exchanger: Condenser / Cooling fan control Outdoor unit heat exchanger: Evaporator / Fan step 7 or 8 |
| Electronic expansion valve (Main) | Y1E | 480 pls | <ul style="list-style-type: none"> Outdoor unit heat exchanger: Condenser / Liquid pressure control Outdoor unit heat exchanger: Evaporator / PI control | <ul style="list-style-type: none"> Outdoor unit heat exchanger: Condenser / Liquid pressure control Outdoor unit heat exchanger: Evaporator / PI control |
| Electronic expansion valve (Subcooling) | Y3E | PI control | PI control | PI control |
| Electronic expansion valve (Refrigerant charge) | Y2E | 41 pls for refrigerant discharge | 41 pls for refrigerant discharge | 41 pls for refrigerant discharge |
| Solenoid valve (Refrigerant regulator hot gas) | Y1S | ON for refrigerant discharge | ON for refrigerant discharge | ON for refrigerant discharge |
| Solenoid valve (Refrigerant regulator liquid pipe) | Y2S | ON for refrigerant recovery | ON for refrigerant recovery | ON for refrigerant recovery |
| Solenoid valve (Refrigerant regulator gas vent pipe) | Y3S | ON for refrigerant recovery | ON for refrigerant recovery | ON for refrigerant recovery |
| Solenoid valve (Hot gas) | Y4S | OFF | OFF | OFF |
| Solenoid valve (Circuit of oil return) | Y5S | ON | ON | ON |
| Four way valve (Heat exchanger switch) | Y6S | OFF | <ul style="list-style-type: none"> Outdoor unit heat exchanger: Condenser / OFF Outdoor unit heat exchanger: Evaporator / ON | <ul style="list-style-type: none"> Outdoor unit heat exchanger: Condenser / OFF Outdoor unit heat exchanger: Evaporator / ON |
| Four way valve (Dual pressure gas pipe) | Y7S | ON | OFF | OFF |
| Four way valve (Mixing unit) | Y8S | OFF | OFF | OFF |
| Solenoid valve (Mixing unit inlet) | Y9S | OFF | OFF | OFF |

<Indoor Unit>

| Part Name | Electric Symbol | Normal cooling | | | Normal heating | | |
|-----------------------------------|-----------------|---------------------------|---------------------------|---------------|---------------------------|---------------------|---------------|
| | | Thermostat ON unit | Thermostat OFF unit | Stopping unit | Thermostat ON unit | Thermostat OFF unit | Stopping unit |
| Indoor unit fan | M1F | Remote controller setting | Remote controller setting | OFF | Remote controller setting | LL | OFF |
| Electronic expansion valve (Main) | Y1E | Normal opening | 0 pls | 0 pls | Normal opening | 192 pls | 192 pls |

<BS Unit>

| Part Name | Electric Symbol | Normal cooling | Normal heating |
|-----------------------------------|-----------------|--------------------------|--------------------------|
| Electronic expansion valve (EVSC) | Y1E | 0 pls | 0 pls |
| Electronic expansion valve (EVHS) | Y2E | 480 pls (fully opened) | 480 pls (fully opened) |
| Electronic expansion valve (EVLS) | Y3E | 480 pls (fully opened) | 0 pls |
| Electronic expansion valve (EVH) | Y4E | 760 pls (fully opened) | 760 pls (fully opened) |
| Electronic expansion valve (EVL) | Y5E | 760 pls (fully opened) | 0 pls |

2.5.2 Compressor PI Control

Carries out the compressor capacity PI control to maintain T_e at constant during cooling operation and T_c at constant during heating operation to ensure stable unit performance.

[Cooling operation]

Controls compressor capacity to adjust T_e to achieve target value (T_eS).

T_e set value (Make this setting while in Setting mode 2.)

T_e setting

| L | M (Normal) (factory setting) | H | | | | |
|-----|---------------------------------|-----|-----|-----|------|------|
| 3°C | 6°C | 7°C | 8°C | 9°C | 10°C | 11°C |

T_e : Low pressure equivalent saturation temperature (°C)

T_eS : Target temperature of T_e (Varies depending on T_e setting, operating frequency, etc.)

* On multi-outdoor-unit systems, this control is made according to values of the first-priority unit, which is detected with the pressure sensor.

[Heating operation]

Controls compressor capacity to adjust T_c to achieve target value (T_cS).

T_c set value (Make this setting while in Setting mode 2.)

T_c setting

| L | M (Normal) (factory setting) | H |
|------|---------------------------------|------|
| 43°C | 46°C | 47°C |

T_c : High pressure equivalent saturation temperature (°C)

T_cS : Target temperature of T_c (Varies depending on T_c setting, operating frequency, etc.)

* On multi-outdoor-unit systems, this control is made according to values of the first-priority unit, which is detected with the pressure sensor.

2.5.3 Compressor Step Control

Compressor operations vary with the following steps according to information in “2.5.2 Compressor PI Control”.

RQYQ140 · 180PY1

| STEP No. | INV. |
|----------|----------|
| 1 | 52Hz |
| 2 | 56Hz |
| 3 | 62Hz |
| 4 | 68Hz |
| 5 | 74Hz |
| 6 | 80Hz |
| 7 | 88Hz |
| 8 | 96Hz |
| 9 | 104Hz |
| 10 | 110Hz |
| 11 | 116Hz |
| 12 | 124Hz |
| 13 | 132Hz |
| 14 | 144Hz |
| 15 | 158Hz |
| 16 | 166Hz |
| 17 | 176Hz |
| 18 | 188Hz |
| 19 | 202Hz |
| 20 | 210Hz *1 |
| 21 | 218Hz |
| 22 | 232Hz |
| 23 | 248Hz *2 |

← Initial step

*1: Upper limit of Q140 type is 20.
*2: Upper limit of Q180 type is 23.

RQCYQ280 · 360PY1

RQCEQ280 · 360PY1

| STEP No. | Master INV. | Slave INV. |
|----------|-------------|------------|
| 1 | 52Hz | OFF |
| 2 | 56Hz | OFF |
| 3 | 62Hz | OFF |
| 4 | 68Hz | OFF |
| 5 | 74Hz | OFF |
| 6 | 80Hz | OFF |
| 7 | 88Hz | OFF |
| 8 | 96Hz | OFF |
| 9 | 104Hz | OFF |
| 10 | 110Hz | OFF |
| 11 | 116Hz | OFF |
| 12 | 124Hz | OFF |
| 13 | 132Hz | OFF |
| 14 | 144Hz | OFF |

| | | |
|----|-------|----------|
| 1 | 52Hz | 52Hz |
| 2 | 56Hz | 56Hz |
| 3 | 62Hz | 62Hz |
| 4 | 66Hz | 66Hz |
| 5 | 70Hz | 70Hz |
| 6 | 74Hz | 74Hz |
| 7 | 80Hz | 80Hz |
| 8 | 88Hz | 88Hz |
| 9 | 92Hz | 92Hz |
| 10 | 96Hz | 96Hz |
| 11 | 104Hz | 104Hz |
| 12 | 110Hz | 110Hz |
| 13 | 116Hz | 116Hz |
| 14 | 124Hz | 124Hz |
| 15 | 132Hz | 132Hz |
| 16 | 144Hz | 144Hz |
| 17 | 158Hz | 158Hz |
| 18 | 166Hz | 166Hz |
| 19 | 176Hz | 176Hz |
| 20 | 188Hz | 188Hz |
| 21 | 202Hz | 202Hz |
| 22 | 210Hz | 210Hz *1 |
| 23 | 218Hz | 218Hz |
| 24 | 232Hz | 232Hz |
| 25 | 248Hz | 248Hz *2 |

← Initial step

*1: Upper limit of Q140 type is 22.
*2: Upper limit of Q180 type is 25.

RQCYQ460 ~ 540PY1

RQCEQ460 ~ 636PY1

| STEP No. | Master INV. | Slave 1 INV. | Slave 2 INV. |
|----------|-------------|--------------|--------------|
| 1 | 52Hz | OFF | OFF |
| 2 | 56Hz | OFF | OFF |
| 3 | 62Hz | OFF | OFF |
| 4 | 68Hz | OFF | OFF |
| 5 | 74Hz | OFF | OFF |
| 6 | 80Hz | OFF | OFF |
| 7 | 88Hz | OFF | OFF |
| 8 | 96Hz | OFF | OFF |
| 9 | 104Hz | OFF | OFF |
| 10 | 110Hz | OFF | OFF |
| 11 | 116Hz | OFF | OFF |
| 12 | 124Hz | OFF | OFF |
| 13 | 132Hz | OFF | OFF |
| 14 | 144Hz | OFF | OFF |

| | | | |
|----|-------|-------|-----|
| 1 | 52Hz | 52Hz | OFF |
| 2 | 56Hz | 56Hz | OFF |
| 3 | 62Hz | 62Hz | OFF |
| 4 | 66Hz | 66Hz | OFF |
| 5 | 70Hz | 70Hz | OFF |
| 6 | 74Hz | 74Hz | OFF |
| 7 | 80Hz | 80Hz | OFF |
| 8 | 88Hz | 88Hz | OFF |
| 9 | 92Hz | 92Hz | OFF |
| 10 | 96Hz | 96Hz | OFF |
| 11 | 104Hz | 104Hz | OFF |
| 12 | 110Hz | 110Hz | OFF |
| 13 | 116Hz | 116Hz | OFF |

| | | | |
|----|-------|-------|-------|
| 1 | 52Hz | 52Hz | 52Hz |
| 2 | 56Hz | 56Hz | 56Hz |
| 3 | 62Hz | 62Hz | 62Hz |
| 4 | 66Hz | 66Hz | 66Hz |
| 5 | 68Hz | 68Hz | 68Hz |
| 6 | 70Hz | 70Hz | 70Hz |
| 7 | 74Hz | 74Hz | 74Hz |
| 8 | 80Hz | 80Hz | 80Hz |
| 9 | 88Hz | 88Hz | 88Hz |
| 10 | 96Hz | 96Hz | 96Hz |
| 11 | 104Hz | 104Hz | 104Hz |
| 12 | 110Hz | 110Hz | 110Hz |
| 13 | 116Hz | 116Hz | 116Hz |
| 14 | 124Hz | 124Hz | 124Hz |
| 15 | 132Hz | 132Hz | 132Hz |
| 16 | 138Hz | 138Hz | 138Hz |
| 17 | 144Hz | 144Hz | 144Hz |
| 18 | 158Hz | 158Hz | 158Hz |
| 19 | 166Hz | 166Hz | 166Hz |
| 20 | 176Hz | 176Hz | 176Hz |
| 21 | 188Hz | 188Hz | 188Hz |
| 22 | 202Hz | 202Hz | 202Hz |
| 23 | 210Hz | 210Hz | 210Hz |
| 24 | 218Hz | 218Hz | 218Hz |
| 25 | 232Hz | 232Hz | 232Hz |
| 26 | 248Hz | 248Hz | 248Hz |
| 27 | 266Hz | 266Hz | 266Hz |

*1: Upper limit of Q140 type is 23.
 *2: Upper limit of Q180 type is 26.
 *3: Upper limit of Q212 type is 27.

← Initial step

RQCEQ712 ~ 848PY1

| STEP No. | Master INV. | Slave 1 INV. | Slave 2 INV. | Slave 3 INV. |
|----------|-------------|--------------|--------------|--------------|
| 1 | 52Hz | OFF | OFF | OFF |
| 2 | 56Hz | OFF | OFF | OFF |
| 3 | 62Hz | OFF | OFF | OFF |
| 4 | 68Hz | OFF | OFF | OFF |
| 5 | 74Hz | OFF | OFF | OFF |
| 6 | 80Hz | OFF | OFF | OFF |
| 7 | 88Hz | OFF | OFF | OFF |
| 8 | 96Hz | OFF | OFF | OFF |
| 9 | 104Hz | OFF | OFF | OFF |
| 10 | 110Hz | OFF | OFF | OFF |
| 11 | 116Hz | OFF | OFF | OFF |
| 12 | 124Hz | OFF | OFF | OFF |
| 13 | 132Hz | OFF | OFF | OFF |
| 14 | 144Hz | OFF | OFF | OFF |

| | | | | |
|----|-------|-------|-----|-----|
| 1 | 52Hz | 52Hz | OFF | OFF |
| 2 | 56Hz | 56Hz | OFF | OFF |
| 3 | 62Hz | 62Hz | OFF | OFF |
| 4 | 66Hz | 66Hz | OFF | OFF |
| 5 | 70Hz | 70Hz | OFF | OFF |
| 6 | 74Hz | 74Hz | OFF | OFF |
| 7 | 80Hz | 80Hz | OFF | OFF |
| 8 | 88Hz | 88Hz | OFF | OFF |
| 9 | 92Hz | 92Hz | OFF | OFF |
| 10 | 96Hz | 96Hz | OFF | OFF |
| 11 | 104Hz | 104Hz | OFF | OFF |
| 12 | 110Hz | 110Hz | OFF | OFF |
| 13 | 116Hz | 116Hz | OFF | OFF |

| | | | | |
|----|-------|-------|-------|-----|
| 1 | 52Hz | 52Hz | 52Hz | OFF |
| 2 | 56Hz | 56Hz | 56Hz | OFF |
| 3 | 62Hz | 62Hz | 62Hz | OFF |
| 4 | 66Hz | 66Hz | 66Hz | OFF |
| 5 | 68Hz | 68Hz | 68Hz | OFF |
| 6 | 70Hz | 70Hz | 70Hz | OFF |
| 7 | 74Hz | 74Hz | 74Hz | OFF |
| 8 | 80Hz | 80Hz | 80Hz | OFF |
| 9 | 88Hz | 88Hz | 88Hz | OFF |
| 10 | 96Hz | 96Hz | 96Hz | OFF |
| 11 | 104Hz | 104Hz | 104Hz | OFF |
| 12 | 110Hz | 110Hz | 110Hz | OFF |
| 13 | 116Hz | 116Hz | 116Hz | OFF |
| 14 | 124Hz | 124Hz | 124Hz | OFF |

| | | | | |
|----|-------|-------|-------|-------|
| 1 | 52Hz | 52Hz | 52Hz | 52Hz |
| 2 | 56Hz | 56Hz | 56Hz | 56Hz |
| 3 | 62Hz | 62Hz | 62Hz | 62Hz |
| 4 | 66Hz | 66Hz | 66Hz | 66Hz |
| 5 | 68Hz | 68Hz | 68Hz | 68Hz |
| 6 | 70Hz | 70Hz | 70Hz | 70Hz |
| 7 | 74Hz | 74Hz | 74Hz | 74Hz |
| 8 | 80Hz | 80Hz | 80Hz | 80Hz |
| 9 | 88Hz | 88Hz | 88Hz | 88Hz |
| 10 | 96Hz | 96Hz | 96Hz | 96Hz |
| 11 | 104Hz | 104Hz | 104Hz | 104Hz |
| 12 | 110Hz | 110Hz | 110Hz | 110Hz |
| 13 | 116Hz | 116Hz | 116Hz | 116Hz |
| 14 | 124Hz | 124Hz | 124Hz | 124Hz |
| 15 | 132Hz | 132Hz | 132Hz | 132Hz |
| 16 | 138Hz | 138Hz | 138Hz | 138Hz |
| 17 | 144Hz | 144Hz | 144Hz | 144Hz |
| 18 | 158Hz | 158Hz | 158Hz | 158Hz |
| 19 | 166Hz | 166Hz | 166Hz | 166Hz |
| 20 | 176Hz | 176Hz | 176Hz | 176Hz |
| 21 | 188Hz | 188Hz | 188Hz | 188Hz |
| 22 | 202Hz | 202Hz | 202Hz | 202Hz |
| 23 | 210Hz | 210Hz | 210Hz | 210Hz |
| 24 | 218Hz | 218Hz | 218Hz | 218Hz |
| 25 | 232Hz | 232Hz | 232Hz | 232Hz |
| 26 | 248Hz | 248Hz | 248Hz | 248Hz |
| 27 | 266Hz | 266Hz | 266Hz | 266Hz |

← Initial step

*1: Upper limit of Q140 type is 23.
 *2: Upper limit of Q180 type is 26.
 *3: Upper limit of Q212 type is 27.

2.5.4 Electronic Expansion Valve PI Control

Main electronic expansion valve EVM control

When the outdoor unit heat exchanging is performed via the evaporator (20SA is set to ON), this function is used to exert PI control on the electronic expansion valve (Y1E) so that the evaporator outlet superheated degree (SH) will become constant.

$$SH = T_g - T_e$$

SH: Evaporator outlet superheated degree (°C)

T_g : Suction pipe temperature (°C) detected by the heat exchanger gas pipe thermistor R4T.

T_e : Low pressure equivalent saturation temperature (°C)

Subcooling electronic expansion valve EVT control

In order to make the maximum use of the subcooling heat exchanger, this function is used to exert PI control on the electronic expansion valve (Y3E) so that the evaporator-side gas pipe superheated degree (SH) will become constant.

$$SH = T_{sh} - T_e$$

SH: Outlet superheated degree of evaporator (°C)

T_{sh}: Suction pipe temperature (°C) detected by the subcooling heat exchanger outlet thermistor R7T

T_e: Low pressure equivalent saturation temperature (°C)

Refrigerant charge electronic expansion valve EVJ control

While in automatic refrigerant charge mode or additional refrigerant charge mode, this function is used to exert PI control on the opening degree of the electronic expansion valve (Y2E) in response to outdoor temperature and close the valve after the completion of refrigerant charge. For normal operation, this electronic expansion valve is set to "41 pls".

2.5.5 Step Control of Outdoor Unit Fans

[Step control of fans]

Used to control the revolutions of outdoor unit fans in the steps listed in table below, according to condition changes.

| STEP No. | Fan revolutions (rpm) | | |
|----------|------------------------------|--------------------------|------------|
| | RQYQ140PY1 RREQ140PY1 | RQYQ180PY1 RREQ180PY1 | RREQ212PY1 |
| 1 | 285 | 285 | 285 |
| 2 | 315 | 315 | 315 |
| 3 | 360 | 360 | 360 |
| 4 | 450 | 450 | 450 |
| 5 | 570 | 570 | 570 |
| 6 | 710 | 710 | 710 |
| 7 | 830 | 855 | 855 |
| 8 | Cooling: 951 Heating: 941 | 1100 | 1100 |

* Figures listed above are all those controlled while in standard mode, which vary when the system is set to high static pressure or capacity precedence mode.

[Control at a low outdoor temperature during cooling]

Secure the liquid pressure and circulating rate in the indoor unit through high pressure control with the outdoor fan when the outdoor temperature is low during cooling. Control the fan with the target T_c (high pressure equivalent saturation temperature) = 34°C

2.5.6 Heat Exchanger Control

While in heating or cool/heat simultaneous operation, ensure target condensing and evaporating temperature by changing over the air heat exchanger of outdoor unit to the evaporator or the condenser in response to loads.

[Single system]

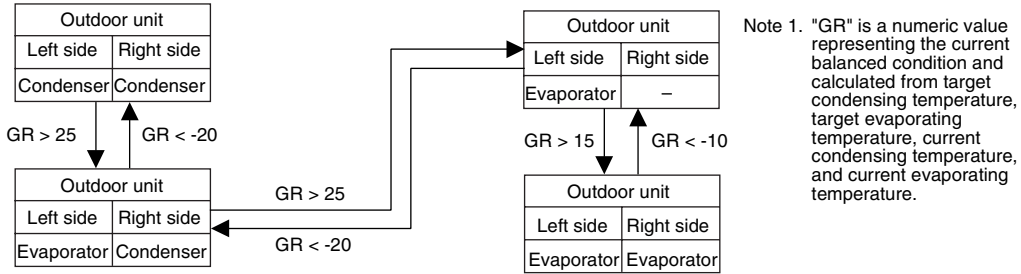

[Multi outdoor unit system]

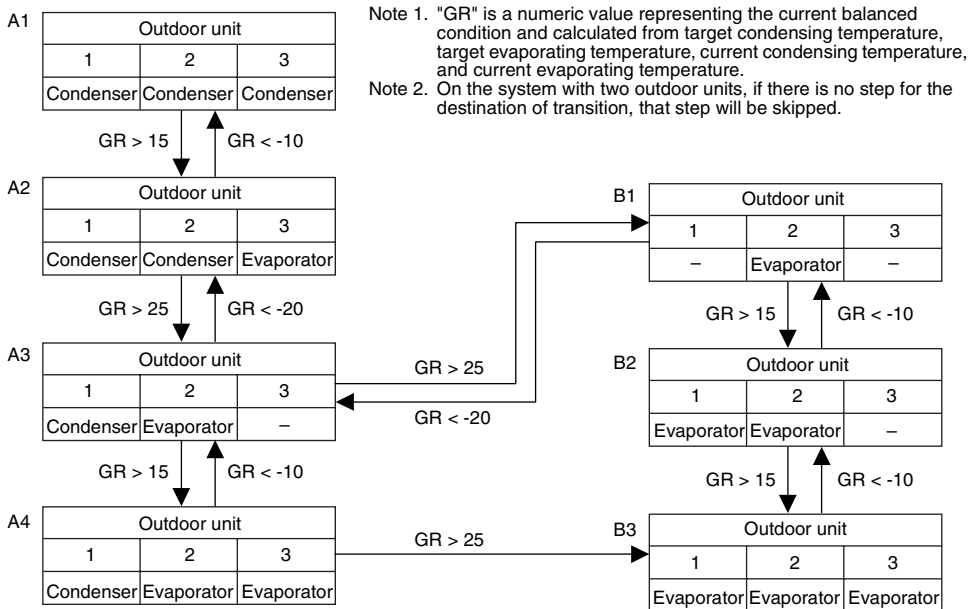

2.5.7 Control of Refrigerant Amount

<Recovery of refrigerant>

Open the solenoid valve (Y2S, Y3S) when the load of the indoor unit is low and return the surplus refrigerant to the refrigerant regulator.

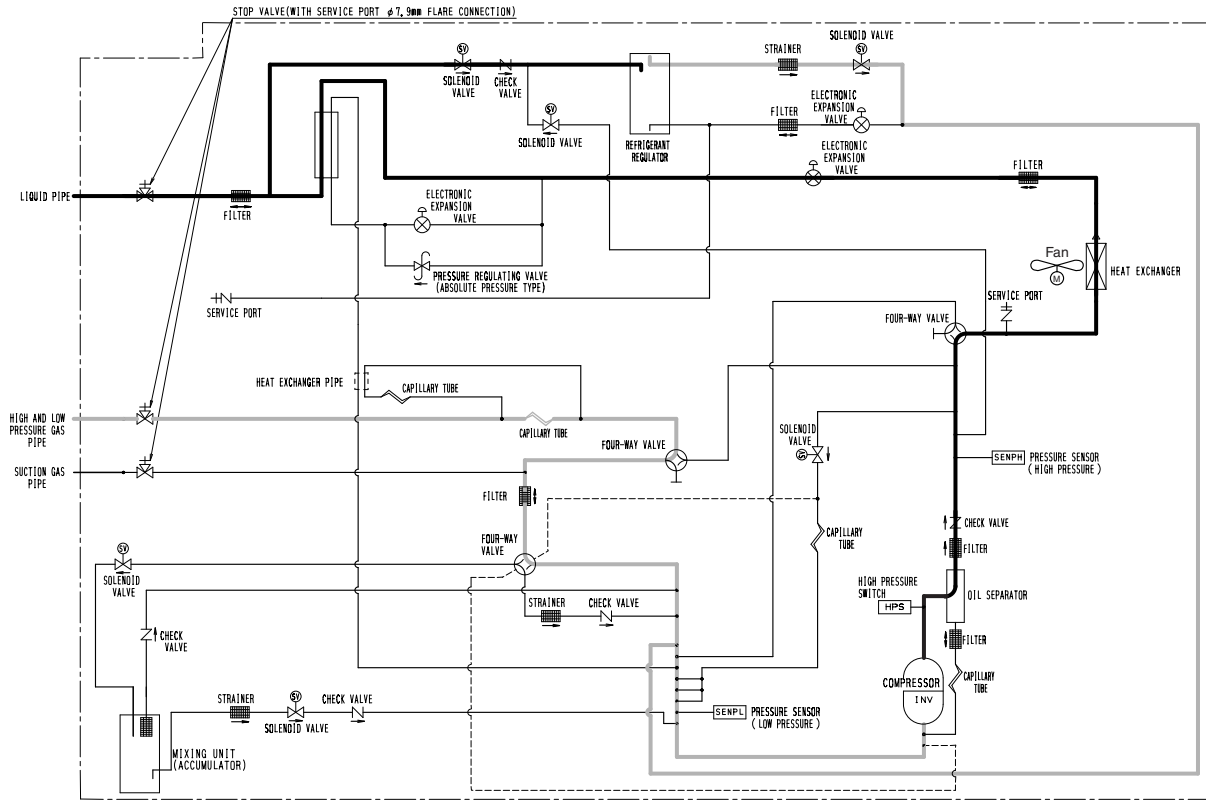

<Discharge of refrigerant>

Open the solenoid valve (Y1S) and the electronic expansion valve (Y2E) when the load of the indoor unit is high and discharge the refrigerant with the refrigerant regulator.

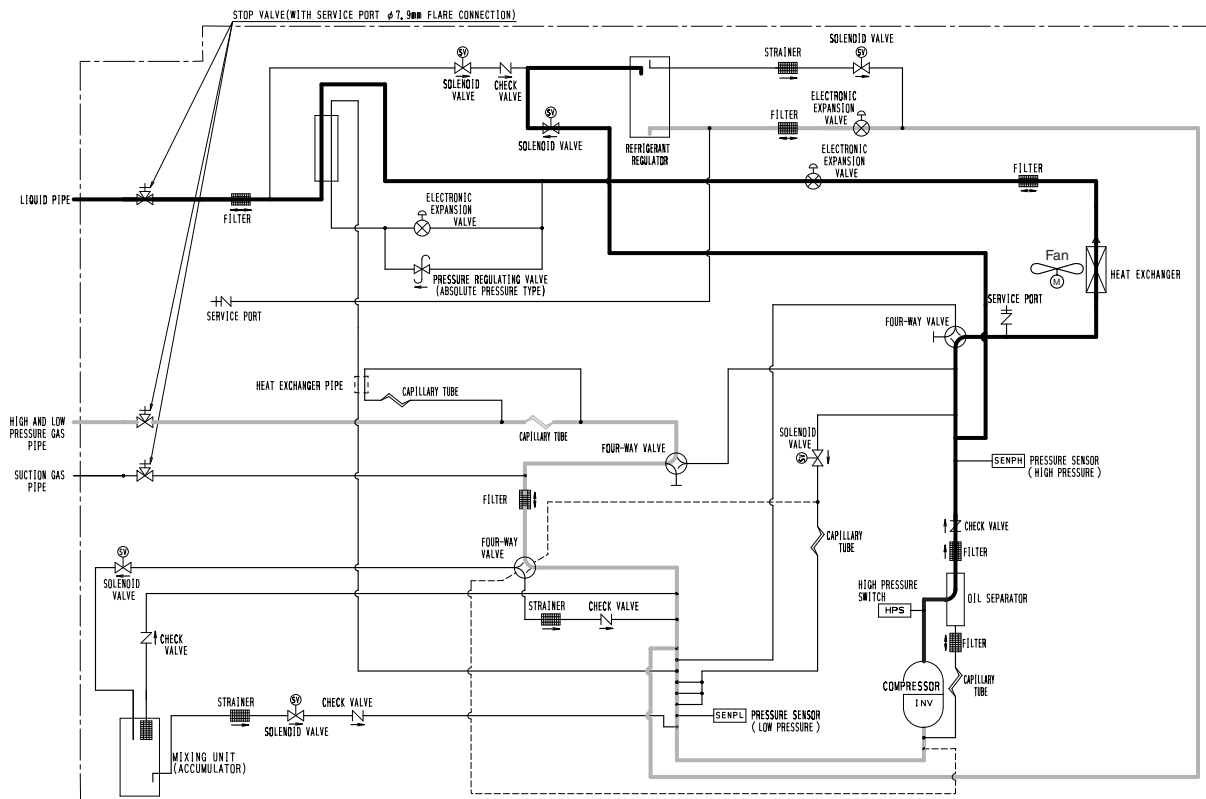

2.6 Protection Control

2.6.1 High Pressure Protection Control

This high pressure protection control is used to prevent the activation of protection devices due to abnormal increase of high pressure and to protect compressors against the transient increase of high pressure.

[In cooling operation]

- ★ In case of multi-outdoor-unit system, the following control is performed in the entire system.
Pc_max indicates the maximum value within the system.

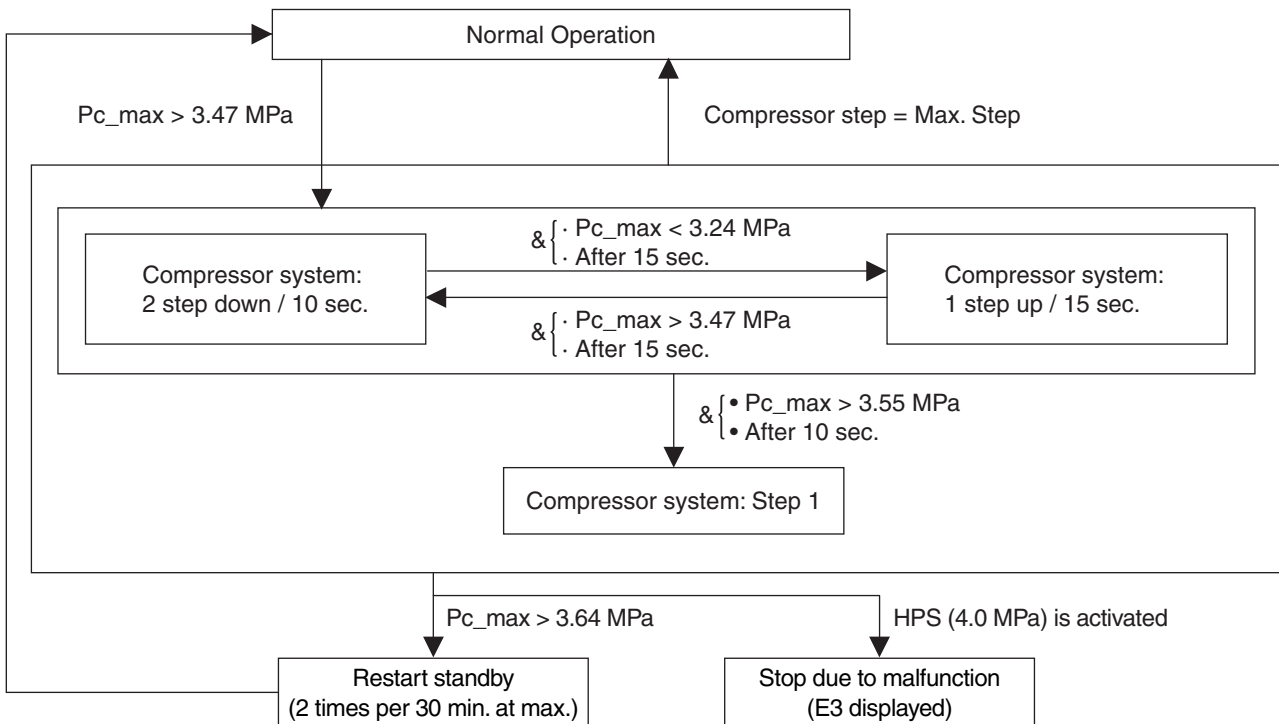

[Heating Operation and Simultaneous Cooling / Heating Operation]

- ★ In case of multi-outdoor-unit system, the following control is performed in the entire system.
Pc_max indicates the maximum value within the system.

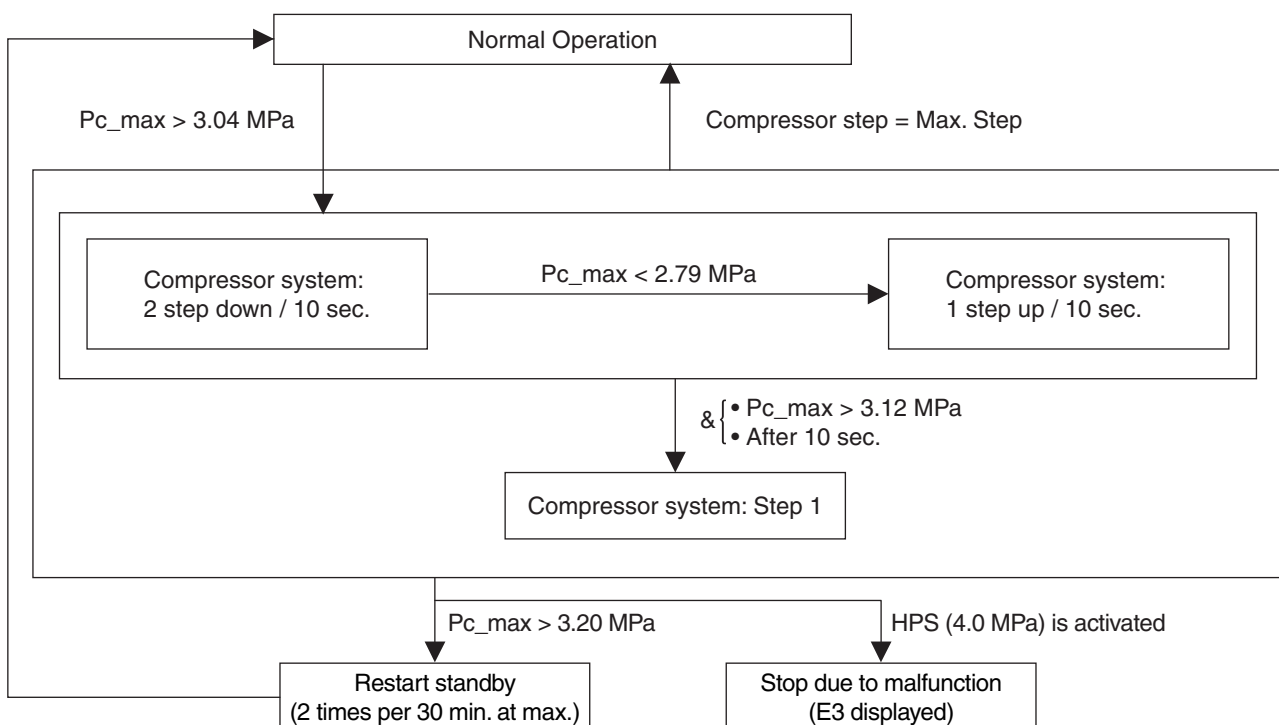

2.6.2 Low Pressure Protection Control

This low pressure protection control is used to protect compressors against the transient decrease of low pressure.

[In cooling operation]

- ★ Because of common low pressure, the following control is performed in the system.
Pe_min indicates the minimum value within the system.

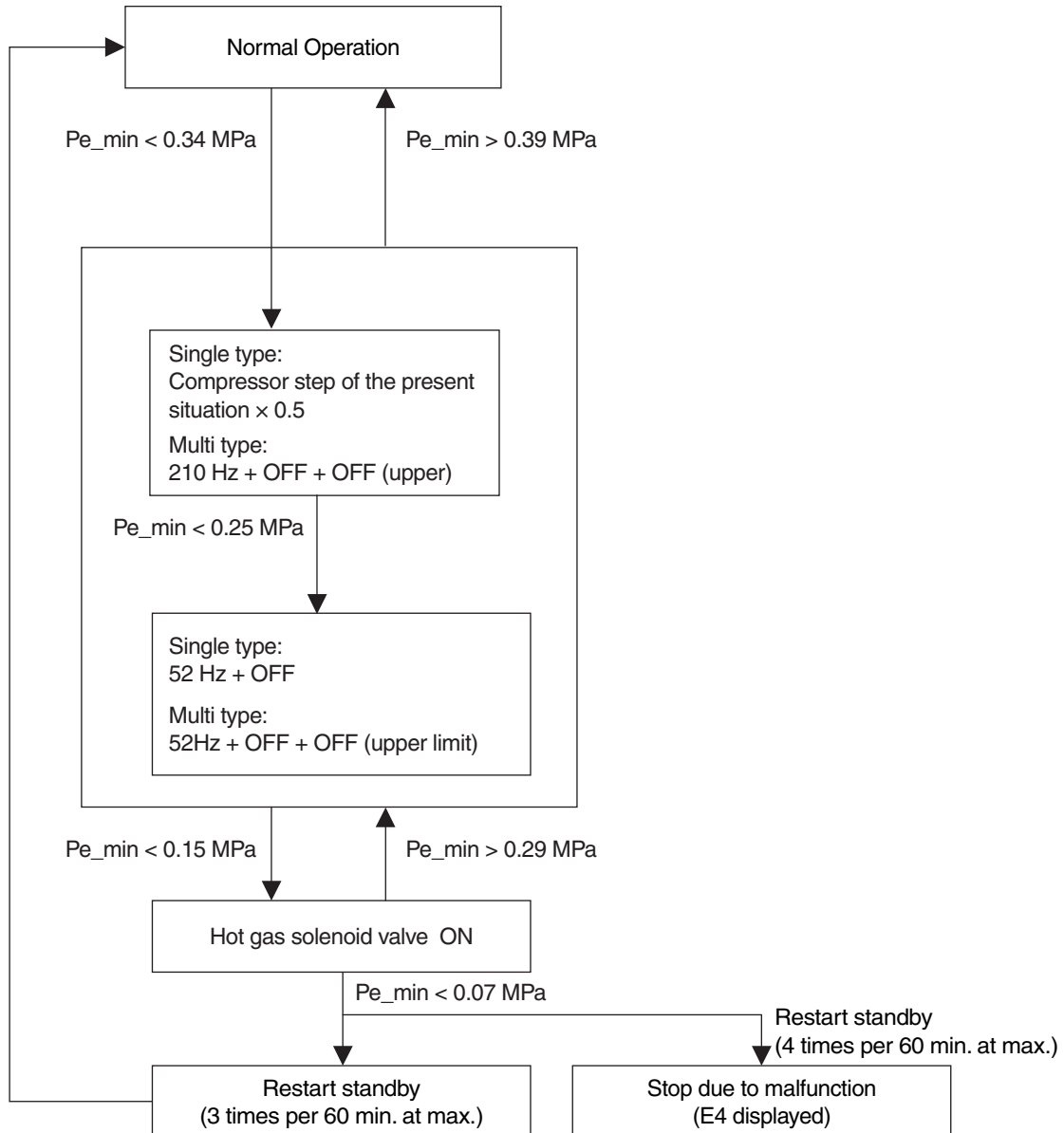

[In heating operation and Simultaneous Cooling / Heating Operation]

- ★ The following control is performed in the system.
Pe_min indicates the minimum value within the system.

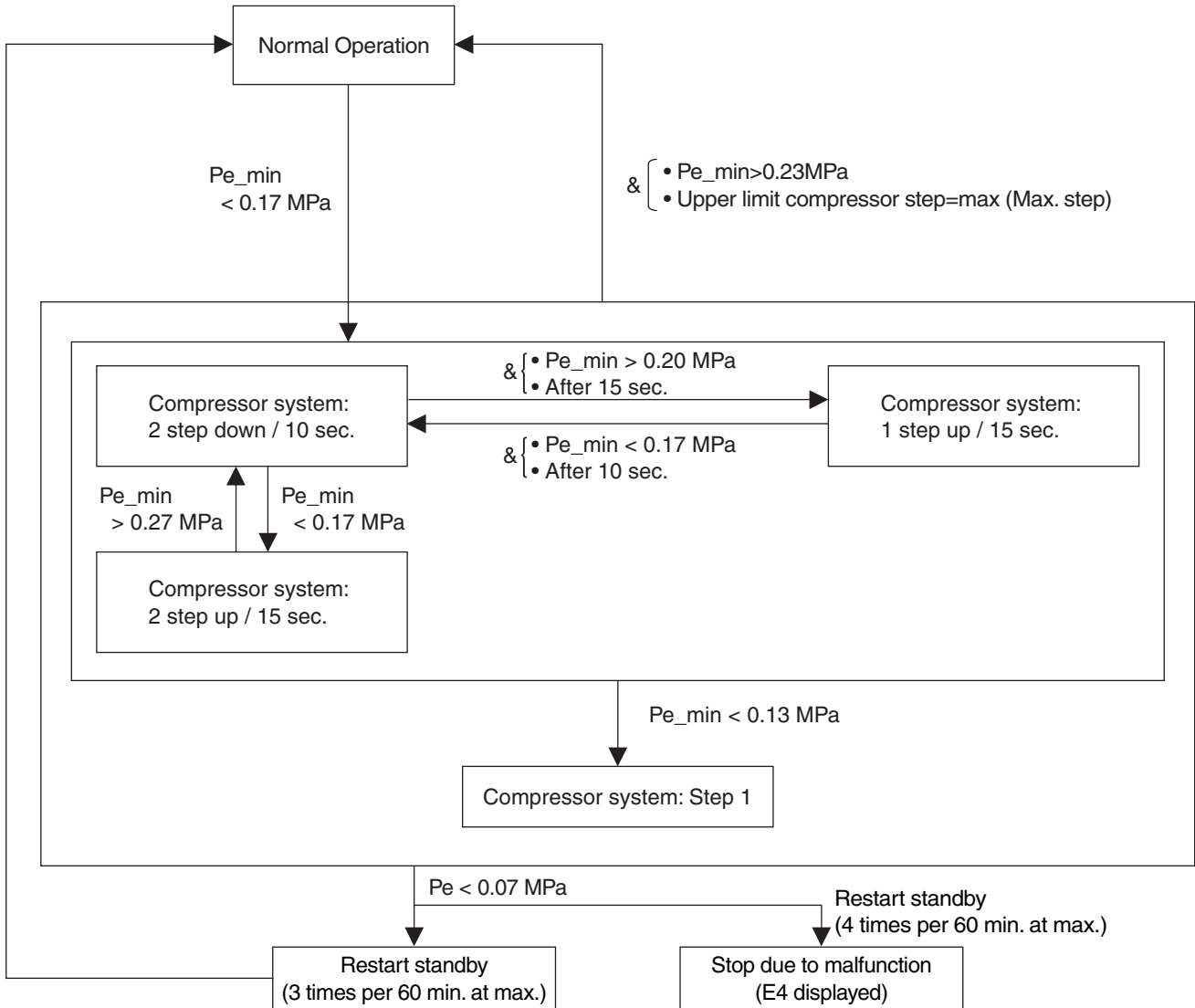

2.6.3 Discharge Pipe Protection Control

This discharge pipe protection control is used to protect the compressor internal temperature against a malfunction or transient increase of discharge pipe temperature.

The following control is performed for each compressor.

[INV compressor]

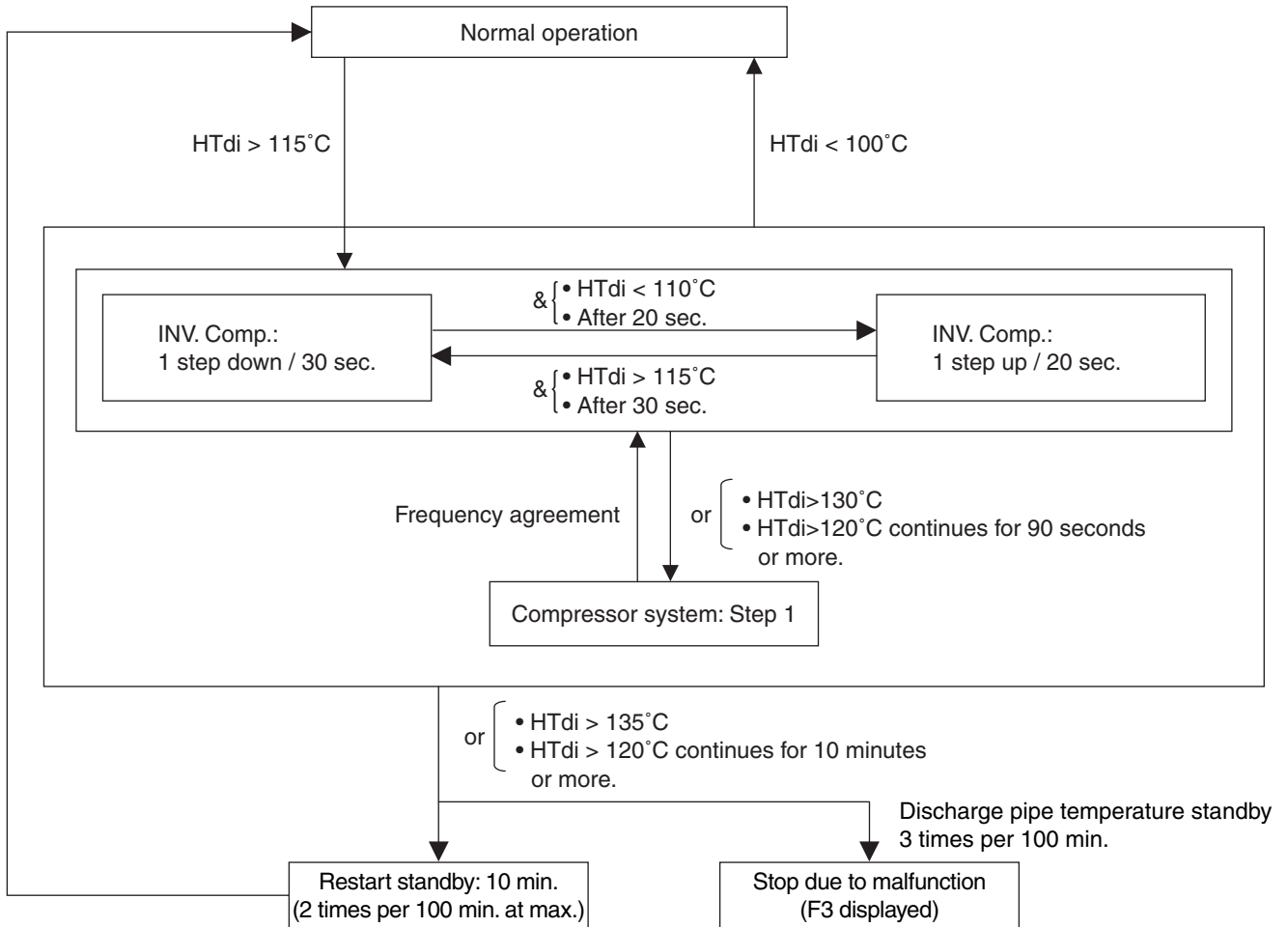

HTdi: Value of INV. compressor discharge pipe temperature compensated with outdoor air temperature.

2.6.4 Inverter Protection Control

Inverter current protection control and inverter fin temperature control are performed to prevent tripping due to a malfunction, or transient inverter overcurrent, and fin temperature increase.

★ In the case of multi-outdoor-unit system, each INV compressor performs these controls in the following sequence.

[Inverter overcurrent protection control]

★ Perform the following control of integrated as well as multi units for each INV compressor.

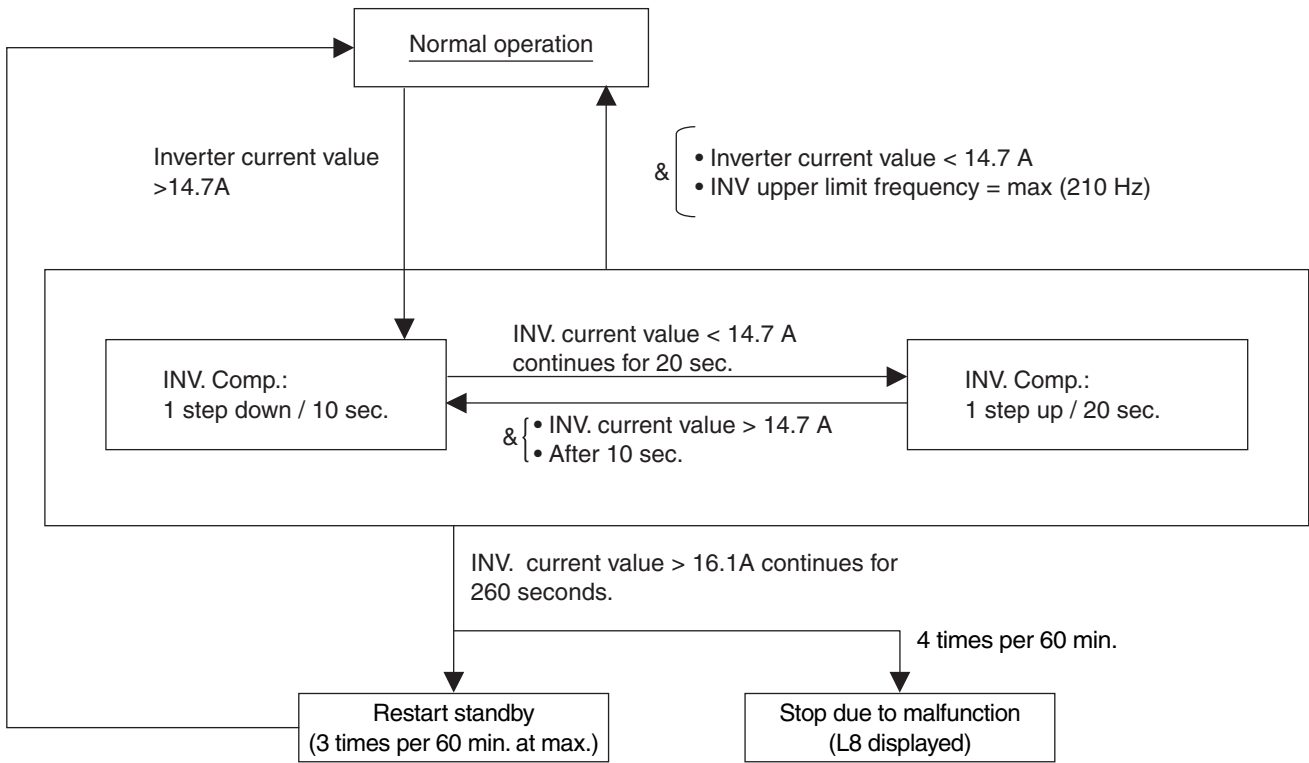

[Inverter fin temperature control]

★ Perform the following control of integrated as well as multi units for each INV compressor.

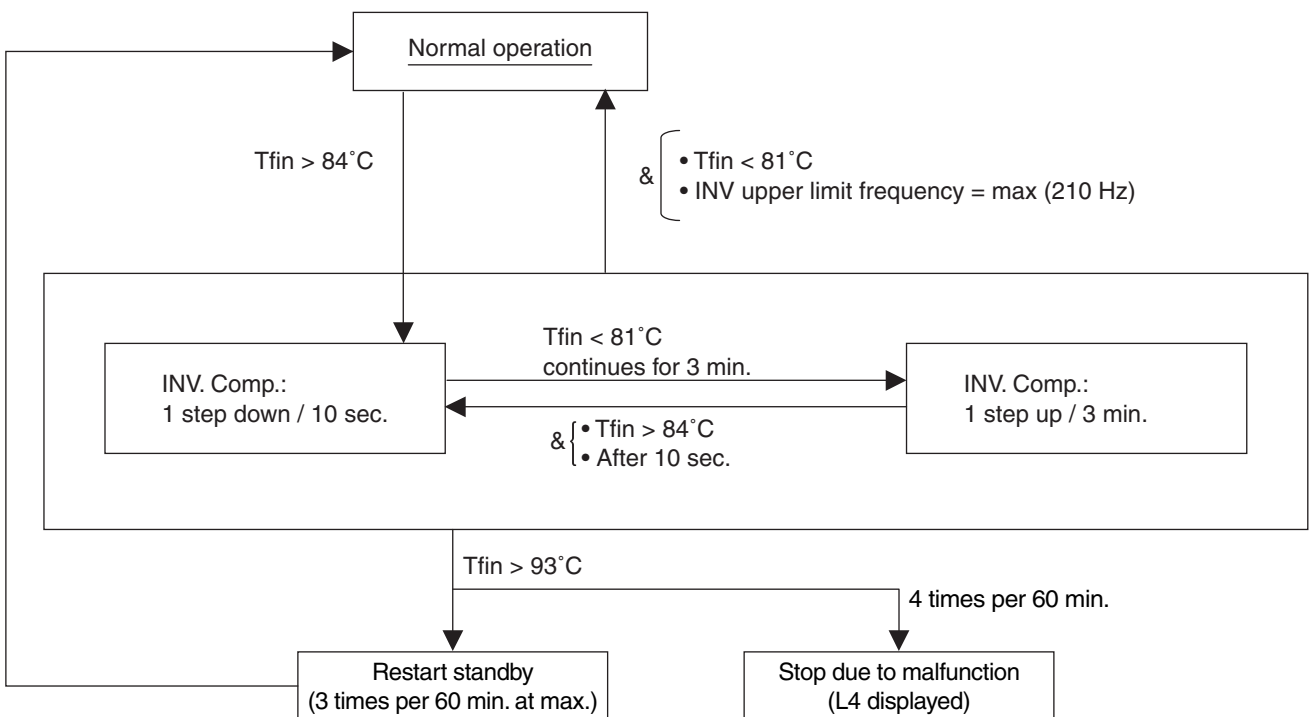

2.7 Special Control

2.7.1 Pump-down Residual Operation

If the liquid refrigerant stays in the evaporator at the startup of a compressor, this liquid refrigerant enters the compressor, thus resulting in diluted oil in the compressor and then degraded lubrication performance.

Consequently, in order to recover the refrigerant in the evaporator while the compressor stops, the pump-down residual operation is conducted.

| Part Name | Electric Symbol | Normal Cooling | | Normal Simultaneous Cooling / Heating | |
|--|-----------------|---|-------------|---|--|
| | | Master Unit | Slave Unit | Master Unit | Slave Unit |
| Compressor | M1C | 124 Hz | OFF | 124 Hz | OFF |
| Outdoor unit fan | M1F | Fan control | Fan control | Fan control | Fan control |
| Electronic expansion valve (Main) | Y1E | 480 pls | 0 pls | Four way valve "ON": 0 pls Four way valve "OFF": 480 pls | Four way valve "ON": 0 pls Four way valve "OFF": 480 pls |
| Electronic expansion valve (Refrigerant charge) | Y2E | 0 pls | 0 pls | 0 pls | 0 pls |
| Electronic expansion valve (Subcooling) | Y3E | 0 pls | 0 pls | 0 pls | 0 pls |
| Solenoid valve (Refrigerant regulator hot gas) | Y1S | OFF | OFF | OFF | OFF |
| Solenoid valve (Refrigerant regulator liquid pipe) | Y2S | OFF | OFF | OFF | OFF |
| Solenoid valve (Refrigerant regulator gas vent pipe) | Y3S | OFF | OFF | OFF | OFF |
| Solenoid valve (Hot gas) | Y4S | OFF | OFF | OFF | OFF |
| Solenoid valve (Circuit of oil return) | Y5S | OFF | OFF | OFF | OFF |
| Four way valve (Heat exchanger switch) | Y6S | OFF | OFF | OFF | OFF |
| Four way valve (Dual pressure gas pipe) | Y7S | OFF | OFF | OFF | OFF |
| Four way valve (Mixing unit) | Y8S | OFF | OFF | OFF | OFF |
| Solenoid valve (Mixing unit inlet) | Y9S | OFF | OFF | OFF | OFF |
| Ending condition | | OR <ul style="list-style-type: none"> • 5 min. passed • Pe_min < 0.49MPa • Pc_max > 2.94MPa • Master unit Tdi > 110°C • Master unit Tp > 125°C | | OR <ul style="list-style-type: none"> • 3 min. passed • Pe_min < 0.25MPa • Pc_max > 3.13MPa • Master unit Tdi > 110°C • Master unit Tp > 140°C | |

2.7.2 Cooling Oil Return Operation

In order to prevent the compressor from running out of oil, the oil return operation is conducted to recover oil flown out from the compressor to the system side.

[Start conditions]

Referring to the set conditions for the following items, start the oil return operation in cooling.

- 2 hours after initial power ON
- A lapse of every 1 ~ 2 hours during low-load operation
- A lapse of every 8 hours during high-load operation

| Part Name | Electric Symbol | Oil return operation |
|--|-----------------|---|
| Compressor | M1C | System frequency in oil return "IN" X 0.8, then constant control under low pressure (* When a unit has been stopped: 52Hz for all units) |
| Outdoor unit fan | M1F | Fan control in normal cooling |
| Electronic expansion valve (Main) | Y1E | 480 pls |
| Electronic expansion valve (Refrigerant charge) | Y2E | 0 pls |
| Electronic expansion valve (Subcooling) | Y3E | 0 pls |
| Solenoid valve (Refrigerant regulator hot gas) | Y1S | OFF |
| Solenoid valve (Refrigerant regulator liquid pipe) | Y2S | OFF |
| Solenoid valve (Refrigerant regulator gas vent pipe) | Y3S | OFF |
| Solenoid valve (Hot gas) | Y4S | OFF |
| Solenoid valve (Circuit of oil return) | Y5S | OFF |
| Four way valve (Heat exchanger switch) | Y6S | OFF |
| Four way valve (Dual pressure gas pipe) | Y7S | OFF |
| Four way valve (Mixing unit) | Y8S | OFF |
| Solenoid valve (Mixing unit inlet) | Y9S | OFF |
| Ending condition | | OR <ul style="list-style-type: none"> • 2 min. passed • TsA-Te < 2°C |

* In the case of multi-outdoor-unit system,

Master unit: Performs the operations listed in the table above.

Slave units: Operating units perform the operations listed in the table above.

Non-operating units perform the operations listed in the table above from the oil return operation.

(Non-operating unit stops during "oil return preparation operation".)

<Indoor Unit>

| Part Name | Electric Symbol | Cooling oil return operation | | |
|-----------------------------------|-----------------|------------------------------|--|---------------|
| | | Thermostat ON unit | Thermostat OFF unit | Stopping unit |
| Indoor unit fan | M1F | Remote controller setting | Remote controller setting | OFF |
| Electronic expansion valve (Main) | Y1E | Normal opening (SHS21) | Normal opening degree for forced thermostat ON | 224 pls |

<BS Unit>

| Part Name | Electric Symbol | Cooling oil return operation |
|-----------------------------------|-----------------|--------------------------------|
| Electronic expansion valve (EVSC) | Y1E | 0 pls |
| Electronic expansion valve (EVHS) | Y2E | 0 ~ 60 pls (Pc_max ~ 2.85 MPa) |
| Electronic expansion valve (EVLS) | Y3E | 480 pls (fully opened) |
| Electronic expansion valve (EVH) | Y4E | 0 pls |
| Electronic expansion valve (EVL) | Y5E | 760 pls (fully opened) |

2.7.3 Heating Oil Return Operation and Defrost Operation

• RQYQ140 · 180PY1, RQCYQ280 ~ 560PY1

[Heating Oil Return Operation]

Referring to the set conditions for the following items, start the oil return operation in heating.

- 2 hours after initial power ON
- A lapse of every 1 ~ 2 hours during low-load operation
- A lapse of every 8 hours during high-load operation

[Defrosting Operation]

To defrost the outdoor unit heat exchanger while in heating operation, the defrost operation is conducted to recover the heating capacity.

[Start conditions]

Referring to the set conditions for the following items, start the defrosting operation.

- A lapse of every 1 hour during high-load operation
- A lapse of every 2 hours during low-load operation

| Part Name | Electric Symbol | Heating oil return and defrost operation |
|--|-----------------|---|
| Compressor | M1C | 188 Hz |
| Outdoor unit fan | M1F | OFF |
| Electronic expansion valve (Main) | Y1E | 480 pls |
| Electronic expansion valve (Refrigerant charge) | Y2E | SH control |
| Electronic expansion valve (Subcooling) | Y3E | By "Adjusting control of the refrigerant amount" |
| Solenoid valve (Refrigerant regulator hot gas) | Y1S | By "Adjusting control of the refrigerant amount" |
| Solenoid valve (Refrigerant regulator liquid pipe) | Y2S | By "Adjusting control of the refrigerant amount" |
| Solenoid valve (Refrigerant regulator gas vent pipe) | Y3S | By "Adjusting control of the refrigerant amount" |
| Solenoid valve (Hot gas) | Y4S | ON |
| Solenoid valve (Circuit of oil return) | Y5S | OFF |
| Four way valve (Heat exchanger switch) | Y6S | OFF |
| Four way valve (Dual pressure gas pipe) | Y7S | ON |
| Four way valve (Mixing unit) | Y8S | OFF |
| Solenoid valve (Mixing unit inlet) | Y9S | OFF |
| Indoor unit fan | M1F | OFF |
| Electronic expansion valve (Main) | Y1E | 1216 pls → Suction SH control |
| Ending condition | | & <ul style="list-style-type: none"> • OR <ul style="list-style-type: none"> • Pc > 2.94 MPa • Tb > 11°C • 12 min. passed • OR <ul style="list-style-type: none"> • 6 min. passed • & <ul style="list-style-type: none"> • TsA-Te > 5°C • 30 sec. passed |

• RQCEQ280 ~ 848PY1

"Reverse cycle defrosting (heating oil return)" and "Partial defrosting" are available depending on the combination of the starting condition for units of this series.

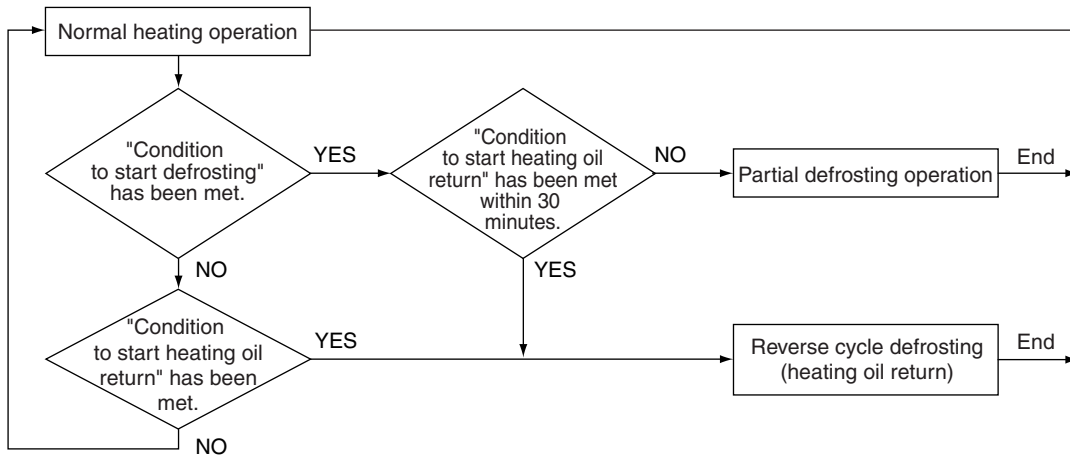

[Defrost operation start conditions]

- A lapse of every 2 hours during low-load operation
- A lapse of every 1 hours during high-load operation

[Heating oil return operation start conditions]

- 2 hours after initial power ON
- A lapse of every 1 ~ 2 hours during low-load operation
- A lapse of every 8 hours during high-load operation

| Part Name | Electric Symbol | Partial defrosting operation | Reverse cycle defrosting (heating oil return) |
|--|-----------------|---|---|
| Compressor | M1C | 124Hz → 232 Hz | 188 Hz |
| Outdoor unit fan | M1F | Defrost unit: OFF Heating unit: Fan control | OFF |
| Electronic expansion valve (Main) | Y1E | Defrost unit: 480 pls Heating unit: 4 pls → Low pressure control | 480 pls |
| Electronic expansion valve (Refrigerant charge) | Y2E | SH control | SH control |
| Electronic expansion valve (Subcooling) | Y3E | By "Adjusting control of the refrigerant amount" | By "Adjusting control of the refrigerant amount" |
| Solenoid valve (Refrigerant regulator hot gas) | Y1S | By "Adjusting control of the refrigerant amount" | By "Adjusting control of the refrigerant amount" |
| Solenoid valve (Refrigerant regulator liquid pipe) | Y2S | By "Adjusting control of the refrigerant amount" | By "Adjusting control of the refrigerant amount" |
| Solenoid valve (Refrigerant regulator gas vent pipe) | Y3S | By "Adjusting control of the refrigerant amount" | By "Adjusting control of the refrigerant amount" |
| Solenoid valve (Hot gas) | Y4S | ON | ON |
| Solenoid valve (Circuit of oil return) | Y5S | OFF | OFF |
| Four way valve (Heat exchanger switch) | Y6S | Defrost unit: OFF Heating unit: ON | OFF |
| Four way valve (Dual pressure gas pipe) | Y7S | Defrost unit: ON Heating unit: OFF | ON |
| Four way valve (Mixing unit) | Y8S | OFF | OFF |
| Solenoid valve (Mixing unit inlet) | Y9S | OFF | OFF |
| Indoor unit fan | M1F | Thermostat ON unit: OFF Others: No instruction | OFF |
| Electronic expansion valve (Main) | Y1E | 0 pls | 1216 pls → Suction SH control |
| Ending condition | | & [<ul style="list-style-type: none"> • OR [<ul style="list-style-type: none"> • Pc > 2.94 MPa • Tb > 11°C • 12 min. passed • OR [<ul style="list-style-type: none"> • 6 min. passed • & [<ul style="list-style-type: none"> • TsA-Te > 5°C • 30 sec. passed | & [<ul style="list-style-type: none"> • OR [<ul style="list-style-type: none"> • Pc > 2.94 MPa • Tb > 11°C • 12 min. passed • OR [<ul style="list-style-type: none"> • 6 min. passed • & [<ul style="list-style-type: none"> • TsA-Te > 5°C • 30 sec. passed |

2.7.4 Outdoor Unit Rotation

In the case of multi-outdoor-unit system, this outdoor unit rotation is used to prevent the compressor from burning out due to unbalanced oil level between outdoor units.

[Details of outdoor unit rotation]

In the case of multi-outdoor-unit system, each outdoor unit is given an operating priority for the control.

Outdoor unit rotation makes it possible to change the operating priority of outdoor units.

Thus, the system becomes free of compressors that stop over an extended period of time at the time of partial loading, preventing unbalanced oil level.

[Timing of outdoor unit rotation]

- or
- At the beginning of the starting control
 - When any of outdoor unit stops for a period of 20 minutes or more (in heating)

Example) The following diagram shows outdoor unit rotation in combination of 3 outdoor units. (in heating)

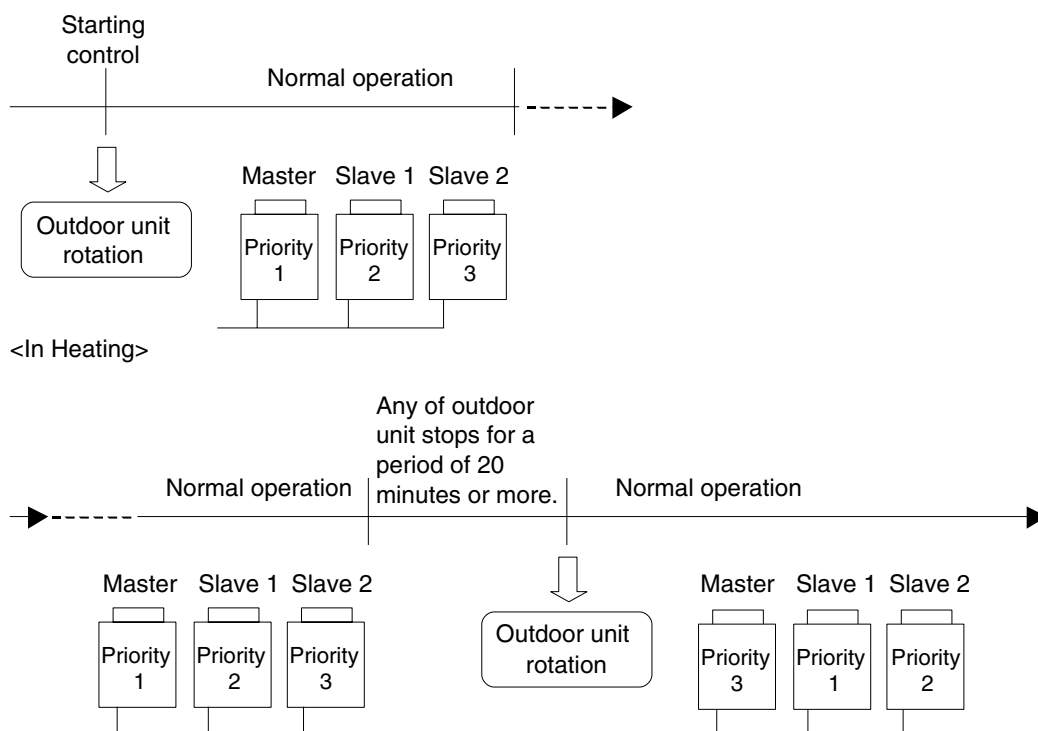

* "Master unit", "slave unit 1" and "slave unit 2" in this section are the names for installation.

They are determined in installation work, and not changed thereafter. (These names are different from "master unit" and "slave unit" for control.)

The outdoor unit connected the control wires (F1 and F2) for the indoor unit should be designated as main unit.

Consequently, The LED display on the main PCB for "master unit", "slave unit 1" and "slave unit 2" do not change.

2.7.5 Cooling/heating mode changeover

[Single room cooling under mixed cooling and heating conditions → heating]

First, close all of the indoor unit electronic expansion valve and BS unit electronic expansion valves Y2E, Y3E, Y4E and Y5E under the cooling operation condition.

Next, open the electronic expansion valve Y2E and perform an equalizing operation. Subsequently, both the electronic expansion valve Y4E and the indoor unit electronic expansion valve open to become a heating circuit. The changeover time is about 6 minutes. (However, this can be shortened from 6 minutes to 4 minutes depending on the onsite setting.)

(1) Cooling operation

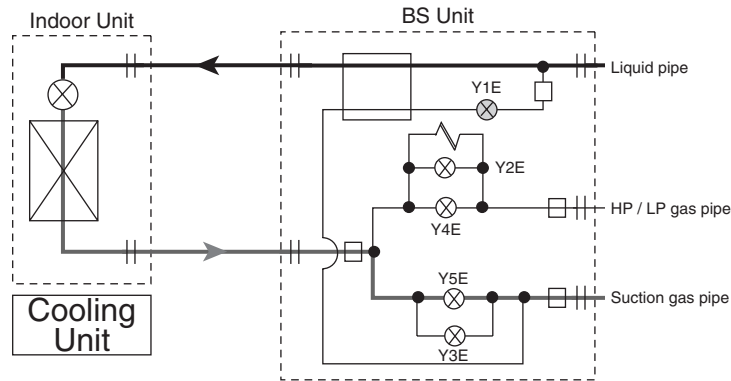

(2) Pressure equalizing

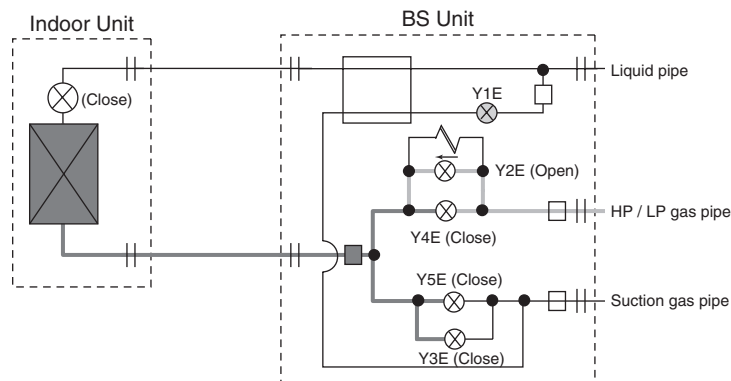

(3) Heating operation

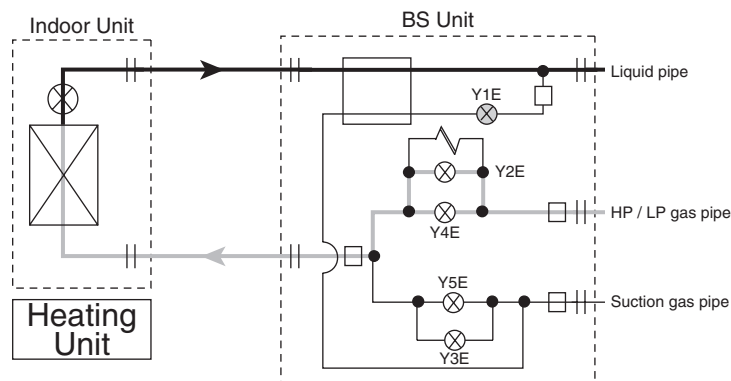

[Single room heating under mixed cooling and heating conditions → cooling]

First, close all of the indoor unit electronic expansion and BS unit electronic expansion valves Y2E, Y3E, Y4E and Y5E under the heating operation condition.

Next, open the electronic expansion valve Y3E and perform an equalizing operation. Subsequently, the electronic expansion valve Y5E opens and the indoor unit electronic expansion valve adjusts the opening extent to become a cooling circuit. The changeover time is about 6 minutes. (However, this can be shortened from 6 minutes to 4 minutes depending on the onsite setting.)

(1) Heating operation

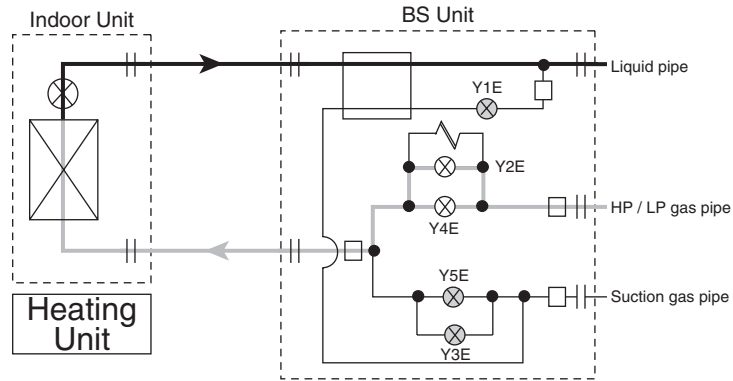

(2) Pressure equalizing

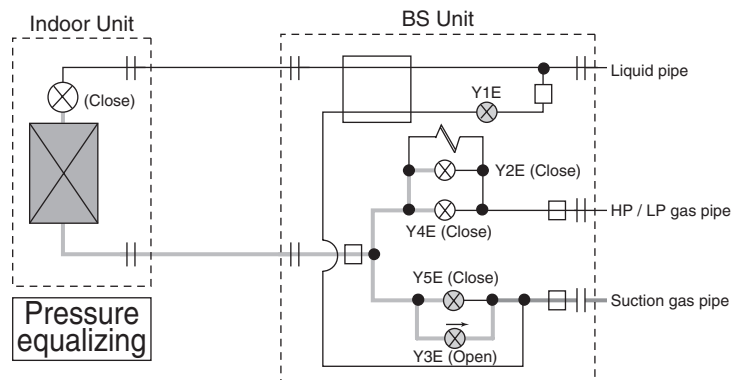

(3) Cooling operation

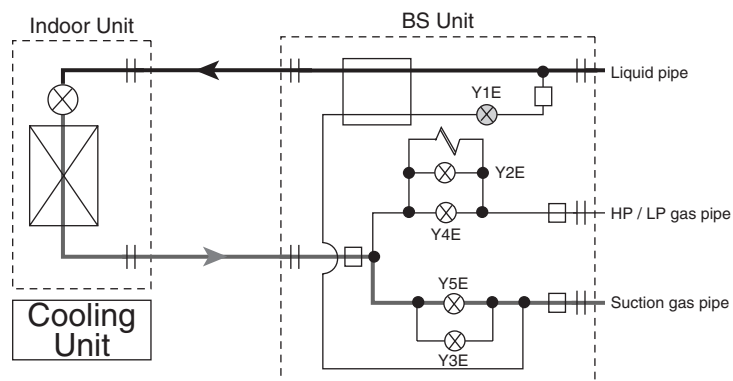

[All-room cooling → all-room heating or simultaneous cooling and heating]

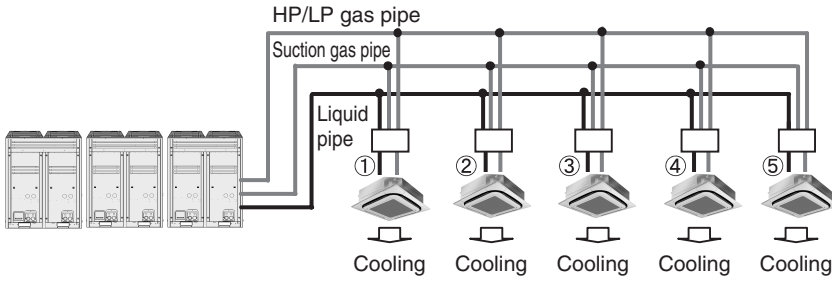

- (1) While all indoor units are in cooling operation
- HP/LP gas pipe is used as a suction gas pipe.

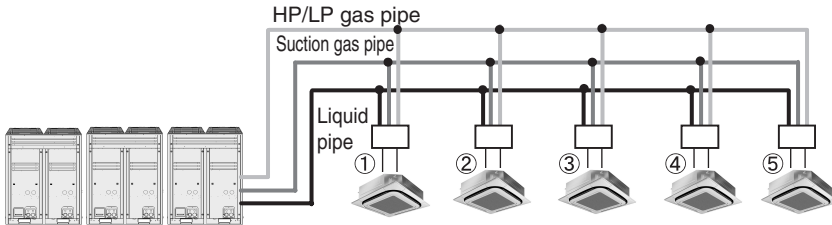

- (2) Mode changeover
- Switch HP/LP gas pipe from low to high pressure
- All indoor units
- Fan stop
 - Changeover time is 3.5 minutes (changeover time for control). (During the changeover: stop the compressor for 30 seconds.)

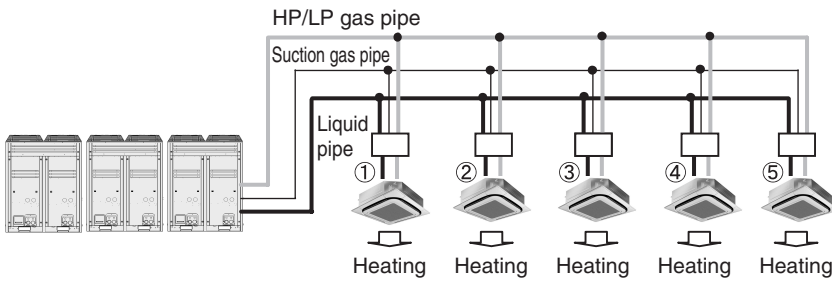

- (3) Heating or simultaneous cooling and heating
- Each indoor unit
- Starts the hot air supply operation by cold air prevention control (3-5 minutes)

[All-room heating or simultaneous cooling and heating → all-room cooling]

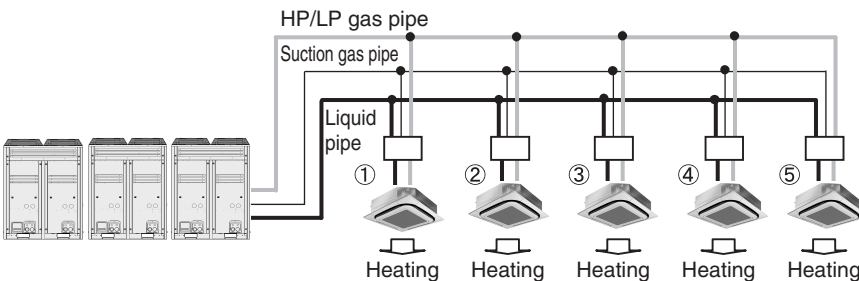

- (1) While the unit is in heating operation or simultaneous cooling and heating operation
- HP/LP gas pipe is used as a discharge gas pipe.

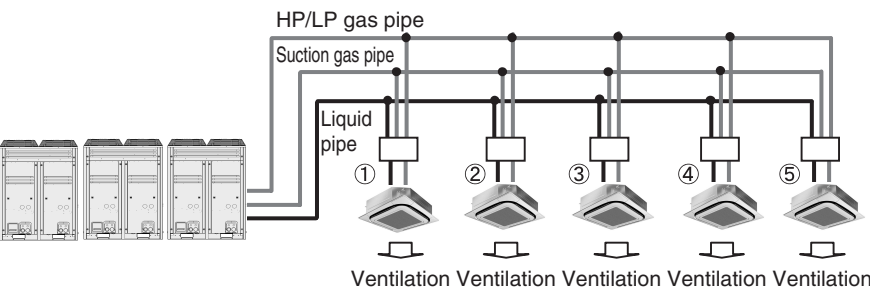

- (2) Mode changeover
- Switch HP/LP gas pipe from high to low pressure
- All indoor units
- Ventilation
 - Changeover time is 3.5 minutes (changeover time for control). (During the changeover: Stop the compressor for 30 seconds.)

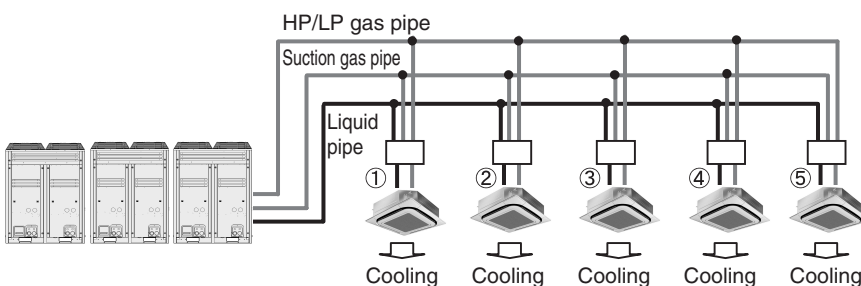

- (3) Change all units to cooling operation.
- Cool air supply operation

2.7.6 Emergency Operation

Stop the compressor or the outdoor unit and bring only the operable compressor and outdoor unit into emergency operation. "Emergency operation by a remote controller" and "Emergency operation by outdoor unit PCB" are available for the operation.

| | Setting method | (1) Emergency operation by remote controller (Automatic backup operation) | (2) Emergency operation by outdoor unit PCB (Manual backup operation) |
|----------------------|----------------|--|--|
| Model | | | |
| RQCYP ~ B, RQCEP ~ B | | Backup operation per outdoor unit | Backup operation per outdoor unit |

• Emergency operation by remote controller

[Operating method]

By setting a remote controller (Press and hold the ON/OFF button for at least 4 seconds.)

[Details of Operation]

Stop the faulty outdoor unit and operate only other outdoor units (This emergency operation is not available for one outdoor unit system).

• Emergency operation by outdoor unit PCB

[Setting method]

Set the compressor to be stopped by the onsite setting (setting mode 2).

(Refer to P. 90 for details of the setting.)

[Operating method]

Stop operating the "Disabled" compressor and outdoor units and operate another compressor and outdoor units. (The emergency operation is not available for a single unit system.)

Part 5

Test Operation

| | |
|--|----|
| 1. Test Operation | 62 |
| 1.1 Procedure and Outline | 62 |
| 1.2 Check Operation | 65 |
| 1.3 Checking in Normal Operation | 68 |
| 2. Field Setting from Outdoor Unit..... | 69 |
| 2.1 Field Setting from Outdoor Unit..... | 69 |

1. Test Operation

1.1 Procedure and Outline

Follow the following procedure to conduct the initial test operation after installation.

1.1.1 Check work prior to turn power supply on

Check that the installation work for the indoor and outdoor units has been performed in accordance with the instructions in the Installation Manual.

Check the below items.

- Power wiring
- Control transmission wiring between units
- Earth wire
- Branch switch
- Earth leakage circuit breaker



- Is the wiring performed as specified?
- Are the branch switches and earth leakage circuit breakers wired correctly?
- Is the designated wire used?
- Is the wiring screw of wiring not loose?
- Is the grounding work completed?
- Is the insulation of the main power supply circuit deteriorated?
Use a 500V megger tester to measure the insulation. (*1)
- Do not use a megger tester for other circuits than 400V or 200V circuit.

*1: Measure to be taken against decreased insulation resistance in the compressor

If the compressor is left to stand for an extended period of time after the refrigerant charge with the stop valve open and the power supply OFF, the refrigerant may be mixed in the compressor, thus decreasing the insulation resistance.

Heat the compressor as shown on the right and then recheck the insulation.

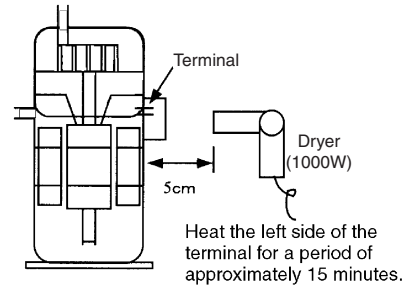

Check on refrigerant piping / insulation materials



- Is the pipe size proper? Are the design pressures for the gas pipe and liquid pipe more than 3.3MPa?
- Is the pipe insulation material installed securely?
Liquid and gas pipes need to be insulated. (Otherwise causes water leak.)

Check air tight test and vacuum drying.



- Have the air tight test and the vacuum drying been conducted according to the procedure in the Installation Manual?

Check on amount of additional refrigerant charge



- Is a proper quantity of refrigerant charged?
* Refer to the following page for the calculation of the amount of additionally refrigerant charge.
- When the refrigerant level is insufficient, leave the liquid and gas stop valves closed and charge with liquid refrigerant via the liquid stop valve service port. (* Do not charge via the gas stop valve service port. Doing so will result in malfunction.)
- Is the amount of additional refrigerant charge recorded in the [Service Precaution] label?

Check the stop valves for conditions.

- Check to be sure the stop valves are under the following conditions.

| Model | Liquid-side stop valve | Gas-side stop valve |
|------------------|------------------------|---------------------|
| RQYQ140 · 180PY1 | Open | Open |

| Model | Liquid-side stop valve | Gas-side stop valve | Dual pressure gas-side stop valve |
|------------------|------------------------|---------------------|-----------------------------------|
| RREQ140 ~ 212PY1 | Open | Open | Open |

* How to calculate additional refrigerant charging amount (Unit: 0.1 kg)

$$R = \left[\left(\frac{\text{Total length of } \phi 22.2\text{-mm liquid pipe}}{\text{Total length of } \phi 22.2\text{-mm liquid pipe}} \right) \times 0.37 + \left(\frac{\text{Total length of } \phi 19.1\text{-mm liquid pipe}}{\text{Total length of } \phi 19.1\text{-mm liquid pipe}} \right) \times 0.26 + \left(\frac{\text{Total length of } \phi 15.9\text{-mm liquid pipe}}{\text{Total length of } \phi 15.9\text{-mm liquid pipe}} \right) \times 0.18 + \left(\frac{\text{Total length of } \phi 12.7\text{-mm liquid pipe}}{\text{Total length of } \phi 12.7\text{-mm liquid pipe}} \right) \times 0.12 + \left(\frac{\text{Total length of } \phi 9.5\text{-mm liquid pipe}}{\text{Total length of } \phi 9.5\text{-mm liquid pipe}} \right) \times 0.059 + \left(\frac{\text{Total length of } \phi 6.4\text{-mm liquid pipe}}{\text{Total length of } \phi 6.4\text{-mm liquid pipe}} \right) \times 0.022 \right] \times A$$

+ B (Correction with outdoor unit capacity) + C (Correction with indoor unit capacity)

| Model | | A | B kg | C kg | |
|-------|--------------|------|---------|-------|-------|
| | | | | ≤100% | >100% |
| RQYQ | 140 · 180PY1 | 1.00 | -2.4kg | 0.0kg | 0.5kg |
| RQCYQ | 280PY1 | 1.02 | -6.8kg | 0.0kg | 0.5kg |
| | 360PY1 | | -6.8kg | | |
| | 460PY1 | | -11.2kg | | |
| | 500PY1 | | -11.2kg | | |
| | 540PY1 | | -11.2kg | | |
| RQCEQ | 280Py1 | 1.02 | -5.2kg | 0.0kg | 0.5kg |
| | 360PY1 | | -5.8kg | | |
| | 460PY1 | | -9.1kg | | |
| | 500PY1 | | -9.4kg | | |
| | 540PY1 | | -9.7kg | | |
| | 636PY1 | | -11.2kg | | |
| | 712PY1 | | -13.8kg | | |
| | 744PY1 | | -14.3kg | | |
| | 816PY1 | | -15.1kg | | |
| | 848PY1 | | -15.6kg | | |

1.1.2 Turn power on

Turn outdoor unit and indoor unit power on.



Check the LED display of the outdoor unit PCB.



Make field settings with outdoor unit PCB.

○ Be sure to turn the power on 6 hours before starting operation to protect compressors.

○ Check to be sure the transmission is normal.
The transmission is normal if the LEDs display conditions as shown in table below.

LED display ○ ON ● OFF ● Blinking

| LED display (Default status before delivery) | Micro-computer operation monitor | MODE | | | TEST | | | COOL / HEAT select | | | Low noise | Demand | Multi |
|---|----------------------------------|------|-----|-----|------|-----|-----|--------------------|-----|-----|-----------|--------|-------|
| | | HAP | H1P | H2P | H3P | H4P | H5P | H6P | H7P | H8P | | | |
| | | | | | | | | | | | | | |
| One outdoor unit installed | ● | ● | ● | ○ | ● | ● | ● | ● | ● | ● | ● | ● | |
| When multiple outdoor unit installed (*) | Master | ● | ● | ● | ○ | ● | ● | ● | ● | ● | ● | ○ | |
| | Slave 1 | ● | ● | ● | ● | ● | ● | ● | ● | ● | ● | ● | |
| | Slave 2 | ● | ● | ● | ● | ● | ● | ● | ● | ● | ● | ● | |
| | Slave 3 | ● | ● | ● | ● | ● | ● | ● | ● | ● | ● | ● | |

(*) The master unit is the outdoor unit to which the transmission wiring for the indoor units is connected.
The other outdoor units are slave units.

○ Make field settings if needed.
(For the setting procedure, refer to information in "Field Setting from Outdoor Unit" on page 69 onward.)
For the outdoor-multi system, make field settings with the master unit.
(Field settings made with the slave unit will be all invalid.)

[Outdoor unit]

[Main PCB]

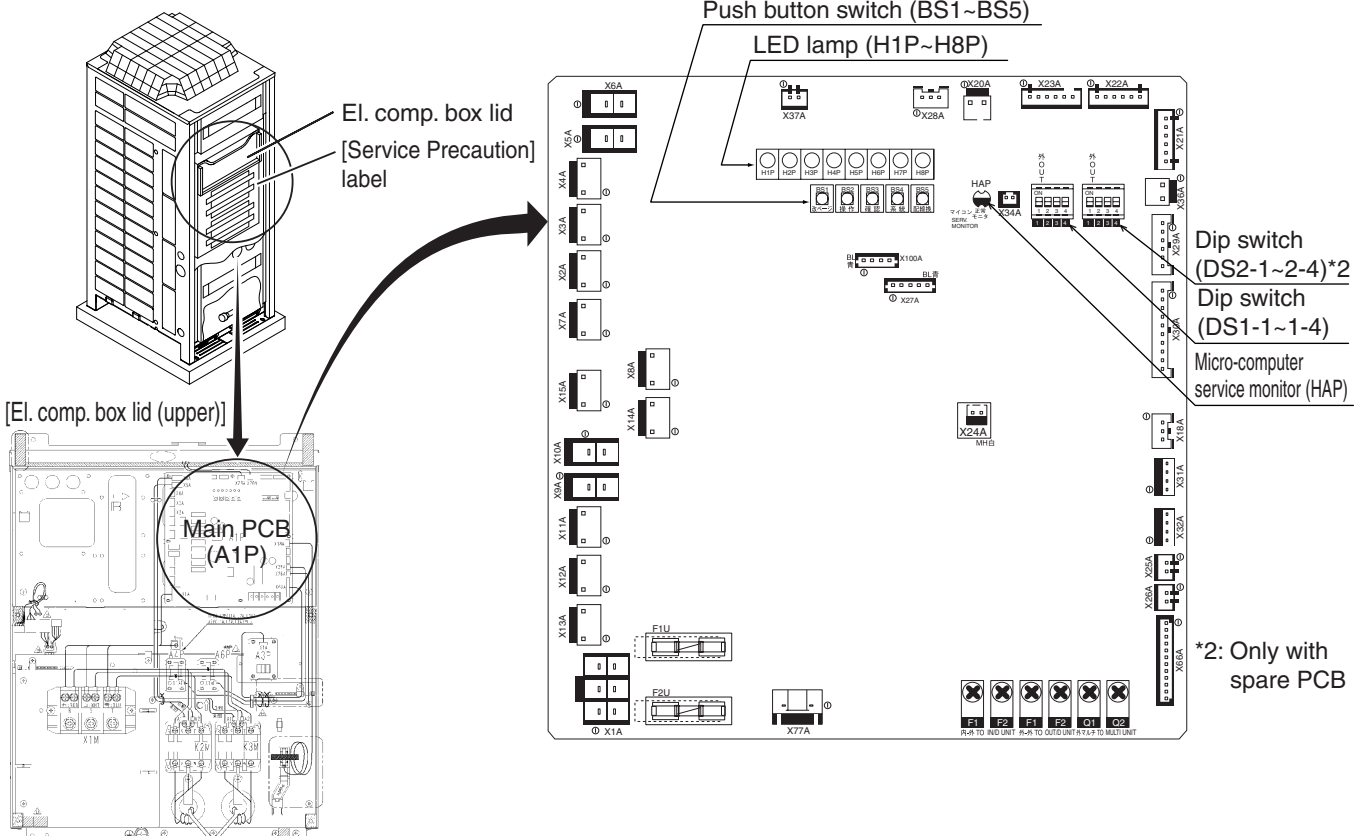

1.2 Check Operation

1.2.1 RQYQ / RQEQ-PY1

| | |
|--|---|
| Procedures | Operational Conditions (Each of mentioned below is a standard operation time. This may vary based on the installation circumstances, etc.) |
| (1) Turn to [Set-up Mode 1] (H1P : OFF). H1P light is usually out. If H1P is (BLINK) or (ON), press "MODE" button (BS1) once to go into [Set-up Mode 1]. (If H2P is lighted-on, check the defect codes with a remote controller to find out the cause. Repair the defect part according to the list on the installation manual.) | Normal (H2P : OFF) Defect (H2P : ON) |
| (2) <u>After confirmed that it's back in a normal condition, press "TEST" button (BS4) for longer than 5 seconds.</u> It starts warming-up for the operation, and LED indication turns as right descriptions. <u>Close all the outside panels after putting back the service cover. (*2)</u> | Startup and waiting operation for stable conditions (approx.10 to 25 min.) The outdoor and indoor unit fan is operated in order to stabilize the refrigerant conditions. And then the compressor starts operation. |
| | Operation to check stop valve and mis-wiring (approx. 5 min.) (Contamination prevention is operated at the same time.) |
| | Operation to check refrigerant amount (approx. 10 to 20 min.) Check the refrigerant amount, and make adjustments. (Contamination prevention is operated at the same time.) |
| <p>1. • When the system stop operation, open the outside panel of the EL.compo. box, then check the LED indications through the inspection door. If the LED indicate as right, connect the <u>refrigerant tank to the refrigerant re-charging port.</u></p> <p>• <u>Press the test operation button (BS4) for longer than 5 seconds</u> after connection of the refrigerant tank. LED change indications, then re-start. (Use a refrigerant cylinder with sufficient amount of refrigerant.)</p> | The system stop operation for warming-ups before re-charging of refrigerant, then LED indicate to connect the refrigerant tank (as on the right). |
| | Stand-by for a stable condition after the re-start. (approx. 1 to 3 min.) |
| <p>2. • <u>Open the valve of the refrigerant tank after LED indications turns as right. (*3)</u></p> <p>• <u>Press the "TEST" button (BS4) once within 3 min.</u> after opening the valve. LED change indications.</p> <p>• <u>Immediately close the inspection door and all the outside panels. (*2)</u></p> | LED indicate to open the valve of the refrigerant tank (as on the right), and wait to press the "TEST" button (BS4). |
| <p>(3) When re-charging is required (*4)</p> <p>If the malfunction code PA is displayed on the remote controller, open the outside panel of the EL. compo.box, check the LED indications through the inspection door.</p> | Operation for re-charging of refrigerant (1~60 min.) (Contamination prevention is operated at the same time.) |
| | The system stop operation due to insufficient re-charging of refrigerant, then LED indicate to replace the refrigerant tank (as on the right). |
| <p>(4) • After the system stop operation, open the outside panel of the EL.compo. box, then check the LED indications through the inspection door.</p> <p>• When completed properly.</p> <ul style="list-style-type: none"> • Disconnect the refrigerant tank. • Close all the outside panels after putting back the inspection door. <p>• When abnormal stop</p> <ul style="list-style-type: none"> • Malfunction code is displayed on the remote controller, check the malfunction code No. | Automatic measuring of piping length (approx.1 min.) This is to check the length of field pipings. |
| | Properly completed (H2P : OFF) |
| | Abnormal stop due to the low pressure drops (H2P: Blinking) |
| | Defect determined (H2P : ON) |

LED indications :OFF :ON :BLINK

| MODE | HWL: | C/H SELECTOR | | | L.N.O.P | DEMAND |
|---|------|--------------|--------|-------|---------|--------|
| | | IND | MASTER | SLAVE | | |
| H1P | H2P | H3P | H4P | H5P | H6P | H7P |
| ● | ● | ○ | ● | ● | ● | ● |
| ● | ○ | ○ | ● | ● | ● | ● |
| ● | ● | ● | ● | ● | ● | ○ |
| ● | ● | ● | ● | ● | ○ | ○ |
| LED indications to connect the refrigerant tank | | | | | | |
| ● | ● | ● | ● | ○ | ● | ● |
| ● | ● | ● | ● | ○ | ● | ● |
| LED indications to [open] the valve of refrigerant | | | | | | |
| ● | ● | ● | ● | ○ | ● | ○ |
| ● | ● | ● | ● | ○ | ● | ○ |
| LED indications as re-charging amount of refrigerant is not sufficient. | | | | | | |
| ● | ● | ● | ● | ○ | ● | ● |
| ● | ● | ● | ● | ○ | ○ | ● |
| ● | ● | ○ | ● | ● | ● | ● |
| ● | ● | ○ | ● | ● | ● | ○ |
| ● | ○ | ○ | ● | ● | ● | ● |

indications on remote controller (*1)

- A
- B
- C
- C
- D (P8)
- C
- C (*3)
- C
- D (PA)
- C
- A
- B (P2)
- B

■ Functions of push-button

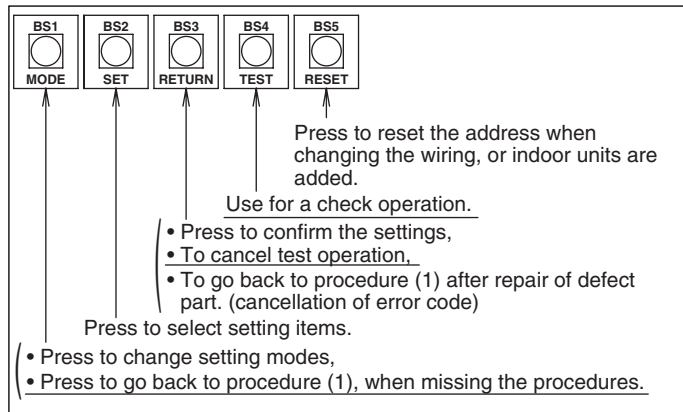

• If the system stops and a indoor remote controller indicates any defect, repair the defect part according to [Remote controller displays malfunction code.] Test operate again after the repair.
 • To test operate again, press the "RETURN" button (BS3) to turn the LED back to "normal" indications as procedure (1).

If the "TEST" button (BS4) is not pressed within 3 min. after the indication to open the valve, it goes back to procedure (3) 1 and stops the system again.

In this case, either refrigerant tank became empty, or the valve of the refrigerant tank is not open.
 • If the refrigerant tank is empty, replace the tank, then press the "TEST" button (BS4) for longer than 5 sec. to re-start the system.
 • If the valve of the refrigerant tank is not open, press the "TEST" button (BS4) for longer than 5 sec. to re-start the system.
 Then open the valve of the refrigerant tank by following the procedure (3) 2.

• If the system stops and a indoor remote controller indicates any defect, repair the defect part according to [Remote controller displays malfunction code.] Test operate again after the repair.
 • To check operate again, press the "RETURN" button (BS3) to turn the LED back to "normal" indications as procedure (1).

(*1) : Please refer to [Remote controller indications at check operation] to confirm the details of each indication.
 (*2) : If outside panels are not closed, it may not be able to operate normally when outdoor temperature is high, etc.
 (*3) : Remote controller does not indicate the procedures. Make sure to check the LED indications upon operation.
 (*4) : Record the amount of refrigerant re-charge on the [Safety precaution] label.

— ⚠ WARNING ⚡ ELECTRIC SHOCK WARNING —

- Do not move away from the outdoor unit if outside panel is not closed during a test operation.
- In case you need to move away from the outdoor unit, follow either one of the below directions
 1. Replace with other installation worker.
 2. Push the "RETURN" button (BS3) to cancel the test operation. (In this case, close all the outside panel, and close also the valve if any cylinder is connected.)

[Remote controller displays malfunction code]

| Malfunction code | Installation error | Remedial action |
|--------------------|---|--|
| A* C* (Note) | Indoor unit of connecting remote controller is malfunction. | Correct the malfunction by reference to installation manual of indoor unit or operation manual of outdoor unit. |
| E3, F4 F3, UF | The shutoff valve of the outdoor unit is left closed. | Open the shutoff valve. |
| U1 | The phases of the power to the outdoor unit are reversed. | Exchange two of the three phases (L1, L2, L3) and connect with the correct phase. |
| U3 | Check operation has been completed normally. | Perform the check operation again. |
| U1 U4 LC | Power is not being supplied (including cases of open phase) to the outdoor or BS or indoor unit. | Supply power correctly to the outdoor, BS or indoor unit. |
| U7 UA | A model which cannot be connected in a multi-outdoor-unit system has been connected in a multi-outdoor-unit system. | Change to individual piping, and disconnect the wiring from the multi-outdoor-unit terminals (Q1, Q2) |
| U9 | There is a problem with another BS and indoor unit within the same system. | A malfunction code is displayed on the remote controller, or else trouble has occurred at BS and indoor unit where a malfunction code is not displayed on the remote controller. Correct the trouble at the corresponding BS and indoor unit. If no malfunction code is displayed on the remote controller, press the Inspection/Test button on the remote controller to display the malfunction code. |
| UF | Wrong wiring between units. | Agree refrigerant system and connection wire between the units. |
| UF | If an outdoor - outdoor transmission wire was connected or disconnected during check operation. | Complete the transmission wiring work, then perform check operation again. |
| U4, U7 UH, UF | Wrong wiring between units. | Connect the interunit wiring (indoor - outdoor, outdoor - outdoor, multi-outdoor-unit). If voltage of 100V or higher was applied to the outdoor unit PCB (A1P), the outdoor unit PCB or BS unit PCB may be damaged. If the malfunction display "UH" appears even after the connection was corrected, the PCB must be replaced. Refer to Service Manual for details. |
| PJ | DIP switch (DS1) setting is incorrect after the outdoor unit PCB (A1P) was replaced. | Follow the information on spare parts with a spare PCB of outdoor unit and make the correct setting. |
| P2 | Check operation cannot be continued by the low pressure drops. | Check the following. <ul style="list-style-type: none"> • All shutoff valves are open. • Refrigerant tank is connected. • Valve of refrigerant tank is open. • Inlet or outlet of indoor unit are not closed due to a foreign object. |
| P8 PA | Instruction to perform additional refrigerant charging during check operation (not a malfunction). | Make the check operation by " 1.2 Check Operation ". |

If any malfunction codes other than the above are displayed, check the service manual for how to respond.

1.3 Checking in Normal Operation

- **After check operation ends, start normal operation.**
(Heating is not possible if the outdoor temperature is 24°C or higher.)
- Check that the indoor and outdoor units are operating correctly.
(If any abnormal noise occurs due to liquid compression in the compressor or another cause, stop operation immediately. Then energize the crankcase heater for a sufficient period of time before restarting operation.)
- Start the indoor units one by one. Verify that the corresponding outdoor unit is operating.
- Verify that cool air (or warm air) is being discharged by the indoor unit.
- Press the airflow direction button and airflow rate button of the indoor unit and verify their operation.

<Important information when checking normal operation>

- If any abnormal noise occurs due to liquid compression in the compressor or another cause, stop operation immediately. Then energize the crankcase heater for a sufficient period of time before restarting operation.
- For approximately 5 minutes after the compressor is stopped, the compressor will not start even when the START/STOP buttons at indoor units in that system are pressed.
- Pump-down residual operation may occur for up to 5 minutes at the outdoor unit after operation was stopped from the remote controller.
- Outdoor unit fan low speed operation may also occur if the Night-time low noise setting or the External low-noise setting is used.
- If check operation after installation was not performed by pressing the TEST button, or if the check operation was not completed normally, error code "U3" appears and normal operation is not possible. Be sure to follow the instructions in "1-2. Check Operation" and complete the check operation procedure.

2. Field Setting from Outdoor Unit

2.1 Field Setting from Outdoor Unit

2.1.1 List of Field Setting Items

This following section indicates the list of field setting items. For the lists of dip switch contents, Setting mode 1, and Setting mode 2, refer to information in tables shown on the following page onward.

For setting items of (*1), refer to detailed information provided on page 80 onward.

(1) Function setting items

| Setting item | | Content and objective of setting | Overview of setting procedure |
|--------------|-------------------------------------|--|---|
| 1 | Setting of COOL/HEAT selection (*1) | <ul style="list-style-type: none"> ■ COOL/HEAT selection methods are possible to select from the following (1) Control by each outdoor unit using the indoor unit remote controller (2) Control by each outdoor unit using the COOL/HEAT selection remote controller (3) Batch control by outdoor unit group using the indoor unit remote controller (4) Batch control by outdoor unit group using the COOL/HEAT selector remote controller | <ul style="list-style-type: none"> ■ In order to use the COOL/HEAT selection remote controller, set the DS1-1 on the outdoor unit PCB to OUT. ■ For outdoor unit group control, set the system to "BATCH MASTER" or "SLAVE" while in "Setting mode 1". Then, make setting of COOL/HEAT batch address. |
| 2 | Setting of low noise operation (*1) | A. Use external input to step down the upper limit of the fan (factory set to Step 8), providing low noise level. (1) Mode 1: Step 6 or lower (2) Mode 2: Step 5 or lower (3) Mode 3: Step 4 or lower | <ul style="list-style-type: none"> ■ Use the "External control adaptor for outdoor unit". Set to "External control adaptor for outdoor unit" with No. 12 of "Setting mode 2" and select the mode with No. 25. If necessary, set the "Capacity precedence setting" to ON with No. 29. |
| | | B. The low noise operation aforementioned is enabled in night-time automatic low noise operation mode. Start time: Possible to select in the range of 20:00 to 24:00 hours. End time: Possible to select in the range of 06:00 to 08:00 hours. (Use the said time as a guide since the start time and the end time are estimated according to outdoor temperatures.) | <ul style="list-style-type: none"> ■ Make this setting while in "Setting mode 2". Select a mode with No. 22 of "Setting mode 2". Select the start time with No. 26 and the end time with No. 27. If necessary, set the "Capacity precedence setting" to ON with No. 29. |
| 3 | Setting of demand operation (*1) | <ul style="list-style-type: none"> ■ Used to place limits on the compressor operating frequency to control the upper limit of power consumption. (1) Mode 1 of Demand 1: 60% or less of rating (2) Mode 2 of Demand 1: 70% or less of rating (3) Mode 3 of Demand 1: 80% or less of rating (4) Demand 2: 40% or less of rating (5) Demand 3: Forced thermostat OFF | <ul style="list-style-type: none"> ■ Method using the external control adaptor for outdoor unit. Select Demand 1 – 3 by short-circuit the terminal strip (TeS1). |
| | | | <ul style="list-style-type: none"> ■ Setting by "Setting mode 2" only. Select Demand 1 or Demand 2 using set No. 32 of "Setting mode 2". If Demand 1 is selected, then also select Level 1 – 3 using set No. 30. |
| 4 | Setting of AIRNET address | <ul style="list-style-type: none"> ■ Used to make address setting with AIRNET connected. | <ul style="list-style-type: none"> ■ Set the AIRNET to an intended address using binary numbers with No. 13 of "Setting mode 2". |
| 5 | Setting of high static pressure | <ul style="list-style-type: none"> ■ Make this setting to operate a system with discharge duct while in high static pressure mode. (Use this setting mode when concealed outdoor unit installation is required on upper floors or balconies.) * In order to mount the discharge duct, remove the cover from the outdoor unit fan. | <ul style="list-style-type: none"> ■ Set No. 18 of "Setting mode 2" to ON. |

(2) Service setting items

| Setting item | | Content and objective of setting | Overview of setting procedure |
|--------------|---|---|--|
| 1 | Indoor unit fan forced H operation | ■ Used to operate the indoor unit in the stopped state in forced H operation mode. | ■ Set No. 5 of "Setting mode 2" to indoor unit forced fan H. |
| 2 | Indoor unit forced operation | ■ Used to operate the indoor unit in forced operation mode. | ■ Set No. 6 of "Setting mode 2" to indoor unit forced operation mode. |
| 3 | Change of targeted evaporation temperature (in cooling) | ■ In cooling operation, used to change the targeted evaporation temperature for compressor capacity control. | ■ Select high side or low side with No. 8 of "Setting mode 2". |
| 4 | Change of targeted condensing temperature (in heating) | ■ In heating operation, used to change the targeted condensing temperature for compressor capacity control. | ■ Select high side or low side with No. 9 of "Setting mode 2". |
| 5 | Setting of defrost selection | ■ Used to change a temperature at which the defrost operation is initiated, thus making the initiation easy or hard. | ■ Select fast side or slow side with No. 10 of "Setting mode 2". |
| 6 | Setting of sequential startup | ■ Used to start units not in sequence but simultaneously. | ■ Set No. 11 of "Setting mode 2" to NONE. |
| 7 | Emergency operation | ■ If the compressor has a failure, used to prohibit the operation of compressor(s) concerned or outdoor unit(s) concerned and to conduct emergency operation of the system only with operable compressor(s) or outdoor unit(s). | ■ Make this setting while in "Setting mode 2". For system with a single outdoor unit: Set with No. 19 or 42. For system with multiple outdoor units: Set with No. 38, 39, or 40. |
| 8 | Air tight test | ■ Fully open the outdoor unit and indoor unit expansion valves, and turn on some of the solenoid valves. | ■ Set No. 21 of "Setting mode 2" to ON. |
| 9 | Refrigerant recovery mode | ■ Used to recover refrigerant on site. With operations of indoor and outdoor units prohibited, fully open the expansion valve of the indoor and outdoor units. | ■ Set No. 21 of "Setting mode 2" to ON. |
| 10 | Vacuumping mode | ■ Used to conduct vacuuming on site. Fully open the expansion valves of the indoor and outdoor units, and energize some of solenoid valves. Use a vacuum pump to conduct vacuuming. | ■ Set No. 21 of "Setting mode 2" to ON. |
| 11 | Power transistor check mode | ■ Used for the troubleshooting of DC compressors. Inverter waveform output makes it possible to judge whether a malfunction results from the compressor or the PCB. | ■ Set No. 28 of "Setting mode 2" to ON. |
| 12 | Setting of model with spare PCB | ■ In order to replace the PCB by a spare one, be sure to make model setting. | ■ For this setting, set the DS2-2, -3, and-4 switches on the PCB to the model concerned. |

■ **Setting by dip switches**

Using dip switches on the PCB enables field setting shown below. However, make no changes of factory settings except for DS1-1.

| Dipswitch | | Setting item | Description |
|-----------------|-------------------|--------------------|--|
| No. | Setting | | |
| DS1-1 | ON | Cool / Heat select | Used to set cool / heat select by Cool/Heat selector equipped with outdoor unit. |
| | OFF (Factory set) | | |
| DS1-2 ~DS1-4 | ON | Not used | Do not change the factory settings. |
| | OFF (Factory set) | | |

Setting at replacement by spare PCB



Caution

DIP switch Setting after changing the main PCB(A1P) to spare parts PCB

After the replacement by the spare PCB, be sure to make settings shown below. When you change the main PCB(A1P) to spare parts PCB, please carry out the following setting.

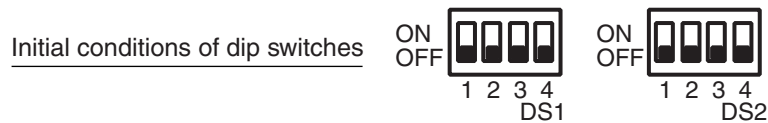

DIP Switch Detail

| DS No. | Item | Contents | | | | | | | | | | | |
|--------|---|--|---|--------------------------|--------------------------|------------|-------|-----|-----|----|-------|-----|----|
| DS1-1 | Cool/Heat changeover setting | ON | COOL/HEAT setting is made with the use of a Cool/Heat selector mounted to the outdoor unit. | | | | | | | | | | |
| | | OFF (Factory setting of spare PCB) | COOL/HEAT setting is not made with the use of a Cool/Heat selector mounted to the outdoor unit. | | | | | | | | | | |
| DS1-2 | Power supply specification | ON | 200V class (220V) | | | | | | | | | | |
| | | OFF (Factory setting of spare PCB) | 400V class (380V) | | | | | | | | | | |
| DS1-3 | Cooling only/Heat-pump setting | ON | Cooling only setting | | | | | | | | | | |
| | | OFF (Factory setting of spare PCB) | Heat pump setting | | | | | | | | | | |
| DS1-4 | Check operation | ON | (1) If check operation was not performed during installation → Do not change the setting. (Leave it OFF.) | | | | | | | | | | |
| | | OFF (Factory setting of spare PCB) | (2) If check operation was completed or normal operation is in progress → Change the setting (OFF → ON). | | | | | | | | | | |
| DS2-1 | Unit allocation setting (Domestic / Overseas) | ON | Do not change factory setting of the spare part (OFF). | | | | | | | | | | |
| DS2-2 | | OFF (Factory setting of spare PCB) | | | | | | | | | | | |
| DS2-3 | Model setting | Make the following settings according to models of outdoor units. | | | | | | | | | | | |
| DS2-4 | | <table border="1"> <thead> <tr> <th></th> <th>RQYQ140PY1 RREQ140PY1</th> <th>RQYQ180PY1 RREQ180PY1</th> <th>RREQ212PY1</th> </tr> </thead> <tbody> <tr> <td>DS2-3</td> <td>OFF</td> <td>OFF</td> <td>ON</td> </tr> <tr> <td>DS2-4</td> <td>OFF</td> <td>ON</td> <td>OFF</td> </tr> </tbody> </table> | | RQYQ140PY1 RREQ140PY1 | RQYQ180PY1 RREQ180PY1 | RREQ212PY1 | DS2-3 | OFF | OFF | ON | DS2-4 | OFF | ON |
| | RQYQ140PY1 RREQ140PY1 | RQYQ180PY1 RREQ180PY1 | RREQ212PY1 | | | | | | | | | | |
| DS2-3 | OFF | OFF | ON | | | | | | | | | | |
| DS2-4 | OFF | ON | OFF | | | | | | | | | | |

■ Setting by push button switches

The following settings are made by push button switches on PCB.

In case of multi-outdoor unit system, various items should be set with the master unit.

(Setting with the slave unit is disabled.)

LED display

| | | MODE H1P | TEST H2P | COOL/HEAT select | | | Low noise H6P | Demand H7P | Multi; H8P |
|-------------------------------|-------------|-------------|-------------|------------------|---------------|--------------|---------------------|---------------|---------------|
| | | | | IND H3P | MASTER H4P | SLAVE H5P | | | |
| Single-outdoor-unit system | | ● | ● | ○ | ● | ● | ● | ● | ● |
| Outdoor- multi system | Master | ● | ● | ○ | ● | ● | ● | ● | ○ |
| | Slave 1 ~ 4 | ● | ● | ● | ● | ● | ● | ● | ● |

(Factory setting)

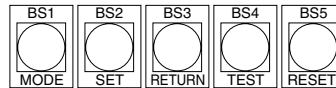

There are the following three setting modes.

① Setting mode 1 (H1P off)

Initial status (when normal) : Used to select the cool/heat setting. Also indicates during “abnormal”, “low noise control” and “demand control”.

② Setting mode 2 (H1P on)

Used to modify the operating status and to set program addresses, etc. Usually used in servicing the system.

③ Monitor mode (H1P blinks)

Used to check the program made in Setting mode 2.

■ Mode changing procedure 1

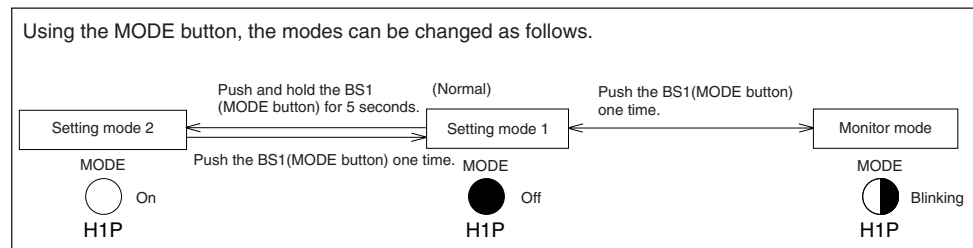

a. "Setting mode 1"

This mode is used to set and check the following items.

1. Set items In order to make COOL/HEAT selection in a batch of outdoor unit group, change the setting.
 - COOL/HEAT selection (IND) Used to select COOL or HEAT by individual outdoor unit (factory set).
 - COOL/HEAT selection (MASTER) Used to select COOL or HEAT by outdoor unit group with the master unit.
 - COOL/HEAT selection (SLAVE) Used to select COOL or HEAT by outdoor unit group with the slave unit.
2. Check items The following items can be checked.
 - (1) Current operating conditions (Normal / Abnormal / In check operation)
 - (2) Setting conditions of COOL/HEAT selection (Individual / Batch master / Batch slave)
 - (3) Low noise operating conditions (In normal operation / In low noise operation)
 - (4) Demand operating conditions (In normal operation / In demand operation)

Procedure for changing COOL/HEAT selection setting

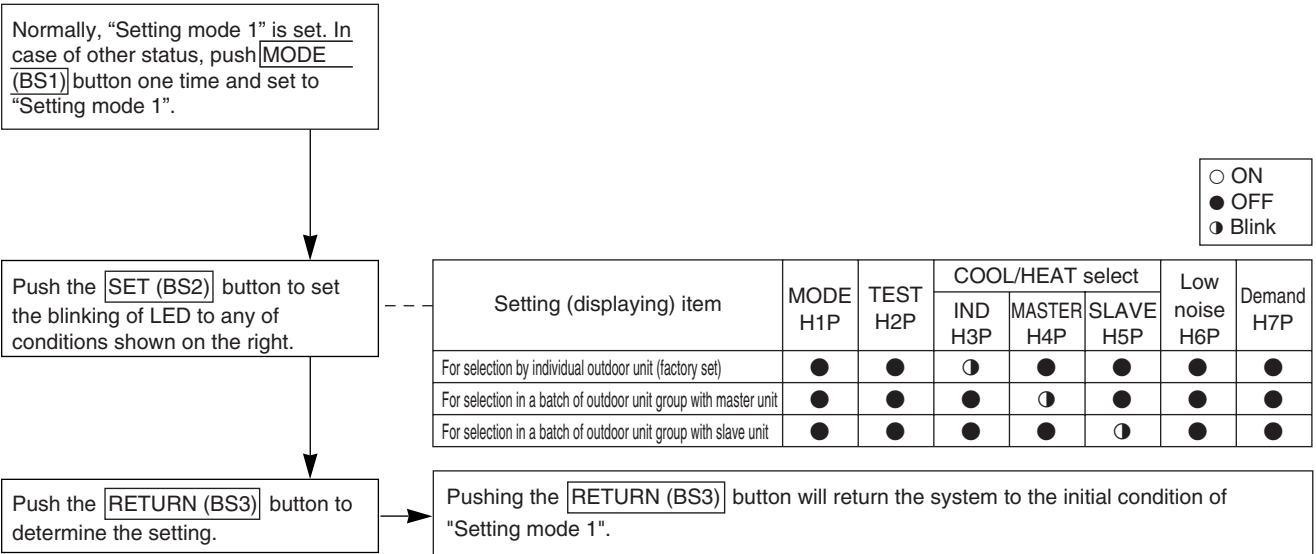

Procedure for checking check items

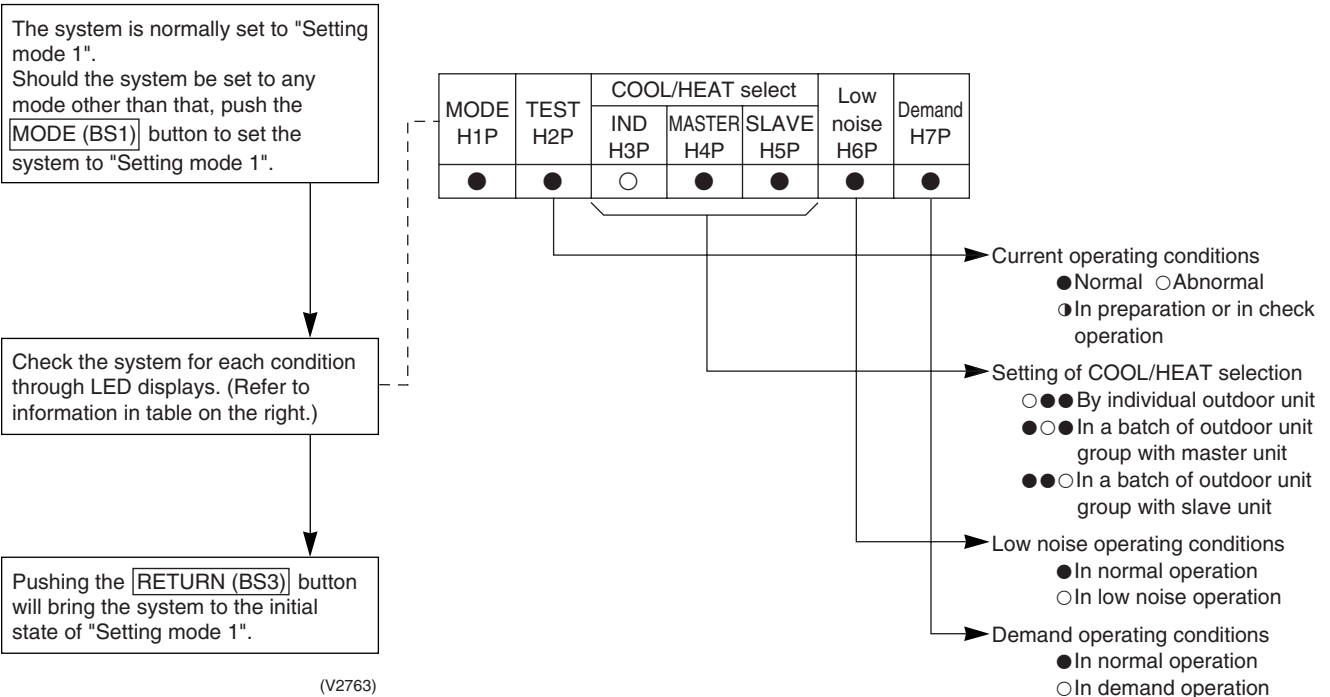

b. "Setting mode 2"

Push and hold the **MODE (BS1)** button for 5 seconds and set to "Setting mode 2".

<Selection of setting items>

Push the **SET (BS2)** button and set the LED display to a setting item shown in the table on the right.
↓
Push the **RETURN (BS3)** button and decide the item. (The present setting condition is blinked.)

<Selection of setting conditions>

Push the **SET (BS2)** button and set to the setting condition you want.
↓
Push the **RETURN (BS3)** button and decide the condition.

Push the **RETURN (BS3)** button and set to the initial status of "Setting mode 2".

* If you become unsure of how to proceed, push the **MODE (BS1)** button and return to setting mode 1.

| No. | Setting item | Description |
|-----|---|---|
| 0 | Digital pressure gauge kit display | Used to make setting of contents to display on the digital pressure gauges (e.g. pressure sensors and temperature sensors) |
| 1 | Cool/heat unified address | Sets address for cool/heat unified operation. |
| 2 | Low noise/demand address | Address for low noise/demand operation |
| 3 | Test operation settings | Used to conduct test operation without making changes to the PCB and replacing the refrigerant, after the completion of maintenance. |
| 5 | Indoor unit forced fan H | Allows forced operation of indoor unit fan while unit is stopped. (H tap) |
| 6 | Indoor unit forced operation | Allows forced operation of indoor unit. |
| 8 | Te setting | Target evaporation temperature for cooling |
| 9 | Tc setting | Target condensation temperature for heating |
| 10 | Defrost changeover setting | Changes the temperature condition for defrost and sets to quick defrost or slow defrost. |
| 11 | Sequential operation setting | Sets sequential operation (Factory set to ON) |
| 12 | External low noise setting / Demand setting | Reception of external low noise or demand signal |
| 16 | Setting of hot water | Make this setting to conduct heating operation with hot water heater. |
| 18 | High static pressure setting | Make this setting in the case of operating in high static pressure mode with diffuser duct mounted. (In order to mount the diffuser duct, remove the cover from the outdoor unit fan.) |
| 20 | Additional refrigerant charge operation setting | Carries out additional refrigerant charge operation. |
| 21 | Refrigerant recovery/vacuuming mode setting | Sets to refrigerant recovery or vacuuming mode. |
| 22 | Night-time low noise setting | Sets automatic nighttime low noise operation in a simple way. The operating time is based on "Starting set" and "Ending set". |
| 25 | Setting of external low noise level | Sets low noise level when the low noise signal is input from outside. |
| 26 | Night-time low noise operation start setting | Sets starting time of nighttime low noise operation. (Night-time low noise setting is also required.) |
| 27 | Night-time low noise operation end setting | Sets ending time of nighttime low noise operation. (Night-time low noise setting is also required.) |
| 28 | Power transistor check mode *Check after disconnection of compressor wires | Used for trouble diagnosis of DC compressor. Since the waveform of inverter is output without wiring to the compressor, it is convenient to probe whether the trouble comes from the compressor or PCB. |
| 29 | Capacity precedence setting | If the capacity control is required, the low noise control is automatically released by this setting during carrying out low noise operation and nighttime low noise operation. |
| 30 | Demand setting 1 | Changes target value of power consumption when demand control 1 is input. |
| 32 | Normal demand setting | Normally enables demand control 1 without external input. (Effective to prevent a problem that circuit breaker of small capacity is shut down due to large load.) |

| No. | Setting item | Description |
|-----|---|--|
| 35 | Setting of difference in elevation for the outdoor unit | Make the setting when the outdoor unit is installed 40 m or more below the indoor unit. |
| 38 | Emergency operation (Setting for the master unit operation prohibition in multi-outdoor-unit system) | Used to temporarily prohibit the applicable outdoor unit from operating should there be any faulty part in multi-outdoor-unit system. Since the comfortable environment is extremely impaired, prompt replacement of the part is required. |
| 39 | Emergency operation (Setting for the slave unit 1 operation prohibition in multi-outdoor-unit system) | |
| 40 | Emergency operation (Setting for the slave unit 2 operation prohibition in multi-outdoor-unit system) | |
| 51 | Master-slave set-up for multi outdoor units | Set up master and slave units for multi-connection outdoor units. After setting up, press the BS5 (RESET) button for 5 seconds or more. |

↑ The numbers in the "No." column represent the number of times to press the SET (BS2) button.

| No. | Setting item display | | | | | | | | Setting condition display * Factory set |
|-----|--|-----------------------|----------------------------------|----------------------------------|----------------------------------|----------------------------------|----------------------------------|----------------------------------|---|
| | Setting item | MODE H1P | TEST H2P | C/H selection | | | Low noise H6P | Demand H7P | |
| | | | | IND H3P | Master H4P | Slave H5P | | | |
| 26 | Night-time low noise operation start setting | <input type="radio"/> | <input checked="" type="radio"/> | <input type="radio"/> | <input type="radio"/> | <input checked="" type="radio"/> | <input type="radio"/> | <input checked="" type="radio"/> | About 20:00 <input type="radio"/> <input checked="" type="radio"/> <input checked="" type="radio"/> <input checked="" type="radio"/> <input checked="" type="radio"/> <input checked="" type="radio"/> <input checked="" type="radio"/> <input type="radio"/> About 22:00 (factory setting) <input type="radio"/> <input checked="" type="radio"/> <input checked="" type="radio"/> <input checked="" type="radio"/> <input checked="" type="radio"/> <input checked="" type="radio"/> <input type="radio"/> <input checked="" type="radio"/> * About 24:00 <input type="radio"/> <input checked="" type="radio"/> <input checked="" type="radio"/> <input checked="" type="radio"/> <input type="radio"/> <input checked="" type="radio"/> <input checked="" type="radio"/> |
| 27 | Night-time low noise operation end setting | <input type="radio"/> | <input checked="" type="radio"/> | <input type="radio"/> | <input type="radio"/> | <input checked="" type="radio"/> | <input type="radio"/> | <input type="radio"/> | About 6:00 <input type="radio"/> <input checked="" type="radio"/> <input checked="" type="radio"/> <input checked="" type="radio"/> <input checked="" type="radio"/> <input checked="" type="radio"/> <input checked="" type="radio"/> <input type="radio"/> About 7:00 <input type="radio"/> <input checked="" type="radio"/> <input checked="" type="radio"/> <input checked="" type="radio"/> <input checked="" type="radio"/> <input type="radio"/> <input checked="" type="radio"/> <input checked="" type="radio"/> About 8:00 (factory setting) <input type="radio"/> <input checked="" type="radio"/> <input checked="" type="radio"/> <input type="radio"/> <input checked="" type="radio"/> <input checked="" type="radio"/> <input checked="" type="radio"/> <input checked="" type="radio"/> * |
| 28 | Power transistor check mode | <input type="radio"/> | <input checked="" type="radio"/> | <input type="radio"/> | <input type="radio"/> | <input type="radio"/> | <input checked="" type="radio"/> | <input checked="" type="radio"/> | OFF <input type="radio"/> <input checked="" type="radio"/> <input checked="" type="radio"/> <input checked="" type="radio"/> <input checked="" type="radio"/> <input checked="" type="radio"/> <input checked="" type="radio"/> <input type="radio"/> * ON <input type="radio"/> <input checked="" type="radio"/> <input checked="" type="radio"/> <input checked="" type="radio"/> <input type="radio"/> <input checked="" type="radio"/> <input checked="" type="radio"/> |
| 29 | Capacity precedence setting | <input type="radio"/> | <input checked="" type="radio"/> | <input type="radio"/> | <input type="radio"/> | <input type="radio"/> | <input checked="" type="radio"/> | <input type="radio"/> | OFF <input type="radio"/> <input checked="" type="radio"/> <input checked="" type="radio"/> <input checked="" type="radio"/> <input checked="" type="radio"/> <input checked="" type="radio"/> <input type="radio"/> <input checked="" type="radio"/> * ON <input type="radio"/> <input checked="" type="radio"/> <input checked="" type="radio"/> <input checked="" type="radio"/> <input type="radio"/> <input checked="" type="radio"/> <input checked="" type="radio"/> |
| 30 | Demand setting 1 | <input type="radio"/> | <input checked="" type="radio"/> | <input type="radio"/> | <input type="radio"/> | <input type="radio"/> | <input type="radio"/> | <input checked="" type="radio"/> | 60 % demand <input type="radio"/> <input checked="" type="radio"/> <input checked="" type="radio"/> <input checked="" type="radio"/> <input checked="" type="radio"/> <input checked="" type="radio"/> <input checked="" type="radio"/> <input type="radio"/> 70 % demand <input type="radio"/> <input checked="" type="radio"/> <input checked="" type="radio"/> <input checked="" type="radio"/> <input checked="" type="radio"/> <input type="radio"/> <input checked="" type="radio"/> <input checked="" type="radio"/> * 80 % demand <input type="radio"/> <input checked="" type="radio"/> <input checked="" type="radio"/> <input type="radio"/> <input checked="" type="radio"/> <input checked="" type="radio"/> <input checked="" type="radio"/> |
| 32 | Normal demand setting | <input type="radio"/> | <input type="radio"/> | <input checked="" type="radio"/> | <input checked="" type="radio"/> | <input checked="" type="radio"/> | <input checked="" type="radio"/> | <input checked="" type="radio"/> | OFF <input type="radio"/> <input checked="" type="radio"/> <input checked="" type="radio"/> <input checked="" type="radio"/> <input checked="" type="radio"/> <input checked="" type="radio"/> <input type="radio"/> <input checked="" type="radio"/> * ON <input type="radio"/> <input checked="" type="radio"/> <input checked="" type="radio"/> <input checked="" type="radio"/> <input type="radio"/> <input checked="" type="radio"/> <input checked="" type="radio"/> |
| 35 | Setting of difference in elevation for the outdoor unit | <input type="radio"/> | <input type="radio"/> | <input checked="" type="radio"/> | <input checked="" type="radio"/> | <input checked="" type="radio"/> | <input type="radio"/> | <input type="radio"/> | Normal <input type="radio"/> <input checked="" type="radio"/> <input checked="" type="radio"/> <input checked="" type="radio"/> <input checked="" type="radio"/> <input checked="" type="radio"/> <input checked="" type="radio"/> <input checked="" type="radio"/> 65 m or less <input type="radio"/> <input checked="" type="radio"/> <input checked="" type="radio"/> <input checked="" type="radio"/> <input type="radio"/> <input checked="" type="radio"/> <input checked="" type="radio"/> <input type="radio"/> |
| 38 | Emergency operation (Master unit with multi-outdoor-unit system is inhibited to operate.) | <input type="radio"/> | <input type="radio"/> | <input checked="" type="radio"/> | <input checked="" type="radio"/> | <input type="radio"/> | <input type="radio"/> | <input checked="" type="radio"/> | OFF <input type="radio"/> <input checked="" type="radio"/> <input checked="" type="radio"/> <input checked="" type="radio"/> <input checked="" type="radio"/> <input checked="" type="radio"/> <input type="radio"/> <input checked="" type="radio"/> * Master unit operation: Inhibited <input type="radio"/> <input checked="" type="radio"/> <input checked="" type="radio"/> <input checked="" type="radio"/> <input type="radio"/> <input checked="" type="radio"/> <input checked="" type="radio"/> |
| 39 | Emergency operation (Slave unit 1 with multi-outdoor-unit system is inhibited to operate.) | <input type="radio"/> | <input type="radio"/> | <input checked="" type="radio"/> | <input checked="" type="radio"/> | <input type="radio"/> | <input type="radio"/> | <input type="radio"/> | OFF <input type="radio"/> <input checked="" type="radio"/> <input checked="" type="radio"/> <input checked="" type="radio"/> <input checked="" type="radio"/> <input checked="" type="radio"/> <input type="radio"/> <input checked="" type="radio"/> * Slave unit 1 operation: Inhibited <input type="radio"/> <input checked="" type="radio"/> <input checked="" type="radio"/> <input checked="" type="radio"/> <input type="radio"/> <input checked="" type="radio"/> <input checked="" type="radio"/> |
| 40 | Emergency operation (Slave unit 2 with multi-outdoor-unit system is inhibited to operate.) | <input type="radio"/> | <input type="radio"/> | <input checked="" type="radio"/> | <input type="radio"/> | <input checked="" type="radio"/> | <input checked="" type="radio"/> | <input checked="" type="radio"/> | OFF <input type="radio"/> <input checked="" type="radio"/> <input checked="" type="radio"/> <input checked="" type="radio"/> <input checked="" type="radio"/> <input checked="" type="radio"/> <input type="radio"/> <input checked="" type="radio"/> * Slave unit 2 operation: Inhibited <input type="radio"/> <input checked="" type="radio"/> <input checked="" type="radio"/> <input checked="" type="radio"/> <input type="radio"/> <input checked="" type="radio"/> <input checked="" type="radio"/> |
| 51 | Master-slave set-up for multi outdoor units | <input type="radio"/> | <input type="radio"/> | <input type="radio"/> | <input checked="" type="radio"/> | <input checked="" type="radio"/> | <input type="radio"/> | <input type="radio"/> | Automatic judgement <input type="radio"/> <input checked="" type="radio"/> <input checked="" type="radio"/> <input checked="" type="radio"/> <input checked="" type="radio"/> <input checked="" type="radio"/> <input checked="" type="radio"/> <input checked="" type="radio"/> * Master <input type="radio"/> <input checked="" type="radio"/> <input checked="" type="radio"/> <input checked="" type="radio"/> <input checked="" type="radio"/> <input checked="" type="radio"/> <input type="radio"/> <input checked="" type="radio"/> Slave 1 <input type="radio"/> <input checked="" type="radio"/> <input checked="" type="radio"/> <input checked="" type="radio"/> <input type="radio"/> <input checked="" type="radio"/> <input checked="" type="radio"/> <input checked="" type="radio"/> Slave 2 <input type="radio"/> <input checked="" type="radio"/> <input checked="" type="radio"/> <input checked="" type="radio"/> <input type="radio"/> <input checked="" type="radio"/> <input checked="" type="radio"/> <input type="radio"/> |

c. Monitor mode

To enter the monitor mode, push the **MODE (BS1)** button when in "Setting mode 1".

<Selection of setting item>

Push the **SET (BS2)** button and set the LED display to a setting item.

<Confirmation on setting contents>

Push the **RETURN (BS3)** button to display different data of set items.

Push the **RETURN (BS3)** button and switches to the initial status of "Monitor mode".

* Push the **MODE (BS1)** button and returns to "Setting mode 1".

| No. | Setting item | LED display | | | | | | | Data display |
|-----|---|-------------|-----|-----|-----|-----|-----|-----|---|
| | | H1P | H2P | H3P | H4P | H5P | H6P | H7P | |
| 0 | Various settings | ● | ● | ● | ● | ● | ● | ● | Lower 4 digits |
| 1 | C/H unified address | ● | ● | ● | ● | ● | ● | ○ | Lower 6 digits |
| 2 | Low noise/demand address | ● | ● | ● | ● | ● | ○ | ● | |
| 4 | AIRNET address | ● | ● | ● | ● | ○ | ● | ● | |
| 5 | Number of connected indoor units *1 | ● | ● | ● | ● | ○ | ● | ○ | |
| 6 | Number of connected BS units *2 | ● | ● | ● | ● | ○ | ○ | ● | |
| 7 | Number of connected zone units (Fixed to "0") | ● | ● | ● | ● | ○ | ○ | ○ | |
| 8 | Number of outdoor units *3 | ● | ● | ● | ○ | ● | ● | ● | Lower 4 digits: upper |
| 9 | Number of BS units *4 | ● | ● | ● | ○ | ● | ● | ○ | |
| 10 | Number of BS units *4 | ● | ● | ● | ○ | ● | ○ | ● | Lower 4 digits: lower |
| 11 | Number of zone units | ● | ● | ● | ○ | ● | ○ | ○ | Lower 6 digits |
| 12 | Number of terminal units *5 | ● | ● | ● | ○ | ○ | ● | ● | Lower 4 digits: upper |
| 13 | Number of terminal units *5 | ● | ● | ● | ○ | ○ | ● | ○ | Lower 4 digits: lower |
| 14 | Contents of malfunction (the latest) | ● | ● | ● | ○ | ○ | ○ | ● | Malfunction code table Refer to P. 106 ~ 109 |
| 15 | Contents of malfunction (1 cycle before) | ● | ● | ● | ○ | ○ | ○ | ○ | |
| 16 | Contents of malfunction (2 cycle before) | ● | ● | ○ | ● | ● | ● | ● | |
| 20 | Contents of retry (the latest) | ● | ● | ○ | ● | ○ | ● | ● | |
| 21 | Contents of retry (1 cycle before) | ● | ● | ○ | ● | ○ | ● | ○ | |
| 22 | Contents of retry (2 cycle before) | ● | ● | ○ | ● | ○ | ○ | ● | |
| 25 | Number of multi connection outdoor units | ● | ● | ○ | ○ | ● | ● | ○ | Lower 6 digits |

The numbers in the "No." column represent the number of times to press the SET (BS2) button.

- *1: Number of connected indoor units
Used to make setting of the number of indoor units connected to an outdoor unit.
- *2: Number of connected BS units
Used to make setting of the number of BS units connected to an outdoor unit.
- *3: Number of outdoor units
Used to make setting of the number of outdoor units connected to DIII-NET that is one of the communication lines.
- *4: Number of BS units
Used to make setting of the number of BS units connected to DIII-NET that is one of the communication lines.
- *5: Number of terminal units
Used to make setting of the number of indoor units connected to DIII-NET that is one of the communication lines.
(Only available for VRV indoor units)

Setting item 0 Display contents of “Number of units for various settings”

| | | | | | | | | |
|--|--------|---|---|---|---|---|---|---|
| EMG operation / backup operation setting | ON | ● | ● | ● | ○ | ● | ● | ● |
| | OFF | ○ | ● | ● | ● | ● | ● | ● |
| Defrost select setting | Short | ○ | ● | ● | ● | ○ | ● | ● |
| | Medium | ○ | ● | ● | ● | ○ | ● | ● |
| | Long | ○ | ● | ● | ● | ● | ● | ● |
| Te setting | L | ○ | ● | ● | ● | ● | ● | ● |
| | M | ○ | ● | ● | ● | ● | ○ | ● |
| | H ①~⑤ | ○ | ● | ● | ● | ● | ○ | ● |
| Tc setting | L | ○ | ● | ● | ● | ● | ● | ● |
| | M | ○ | ● | ● | ● | ● | ● | ○ |
| | H | ○ | ● | ● | ● | ● | ● | ○ |

★ Data such as addresses and number of units is expressed as binary numbers; the two ways of expressing are as follows:

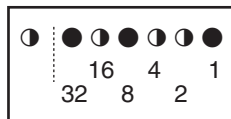

The No. 1 cool/heat unified address is expressed as a binary number consisting of the lower 6 digits. (0 - 63)

In ① the address is 010110 (binary number), which translates to $16 + 4 + 2 = 22$ (base 10 number). In other words, the address is 22.

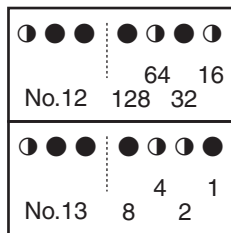

The number of terminal blocks for No. 12 and 13 is expressed as an 8-digit binary number, which is the combination of four upper, and four lower digits for No. 12 and 13 respectively. (0 - 128)

In ② the address for No. 12 is 0101, the address for No. 13 is 0110, and the combination of the two is 01010110 (binary number), which translates to $64 + 16 + 4 + 2 = 86$ (base 10 number). In other words, the number of terminal block is 86.

★ See the preceding page for a list of data, etc. for No. 0 - 25.

2.1.2 Cool / Heat Mode Switching

There are the following 4 cool/heat switching modes.

- ① Set cool/heat separately for each outdoor unit system by indoor unit remote controller.
- ② Set cool/heat separately for each outdoor unit system by cool/heat selector.
- ③ Set cool/heat for more than one outdoor unit system simultaneously in accordance with unified master outdoor unit by indoor unit remote controller.
- ④ Set cool/heat for more than one outdoor unit system simultaneously in accordance with unified master outdoor unit by cool/heat switching remote controller.
- ⑤ Set cool/heat at all outdoor unit systems simultaneously for each outdoor unit external control adaptor by using the central remote controller.

① Set Cool / Heat Separately for Each Outdoor Unit System by Indoor Unit Remote Controller

- ◆ It does not matter whether or not there is outdoor - outdoor unit wiring.
- ◆ Set outdoor unit PCB DS1-1 to IN (factory set).
- ◆ Set cool/heat switching to IND (individual) for "Setting mode 1" (factory set).

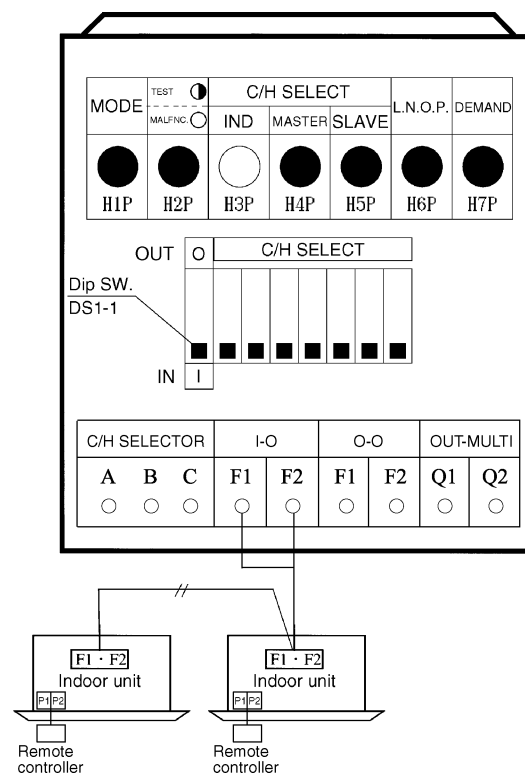

② Set Cool / Heat Separately for Each Outdoor Unit System by Cool / Heat Selector

- ◆ It does not matter whether or not there is outdoor - outdoor unit wiring.
- ◆ Set outdoor unit PCB DS1-1 to OUT (factory set).
- ◆ Set cool/heat switching to IND (individual) for “Setting mode 1” (factory set).

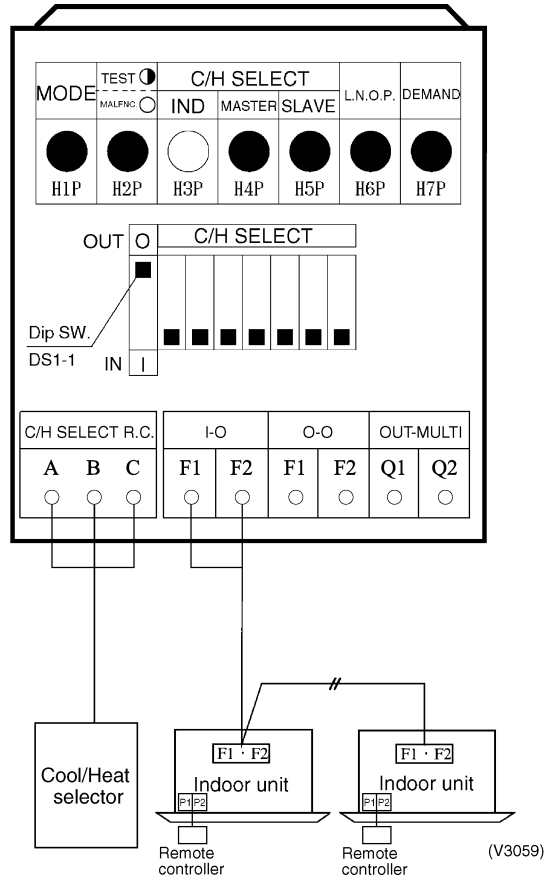

③ Set Cool / Heat for More Than One Outdoor Unit System Simultaneously in Accordance with Unified Master Outdoor Unit by Indoor Unit Remote Controller

- ◆ Install the external control adaptor for outdoor unit on either the outdoor-outdoor, indoor-outdoor transmission line.
- ◆ Set outdoor unit PCB DS1-1 to IN (factory set).
- ◆ In setting mode 1, set the outdoor unit you want to give cool/heat selection permission to as the group master, and set the other outdoor units as group slave units.
- ◆ Set the outdoor unit external control adaptor SS1 to BOTH (factory set) or C/H, and SS2 to OFF (factory set).

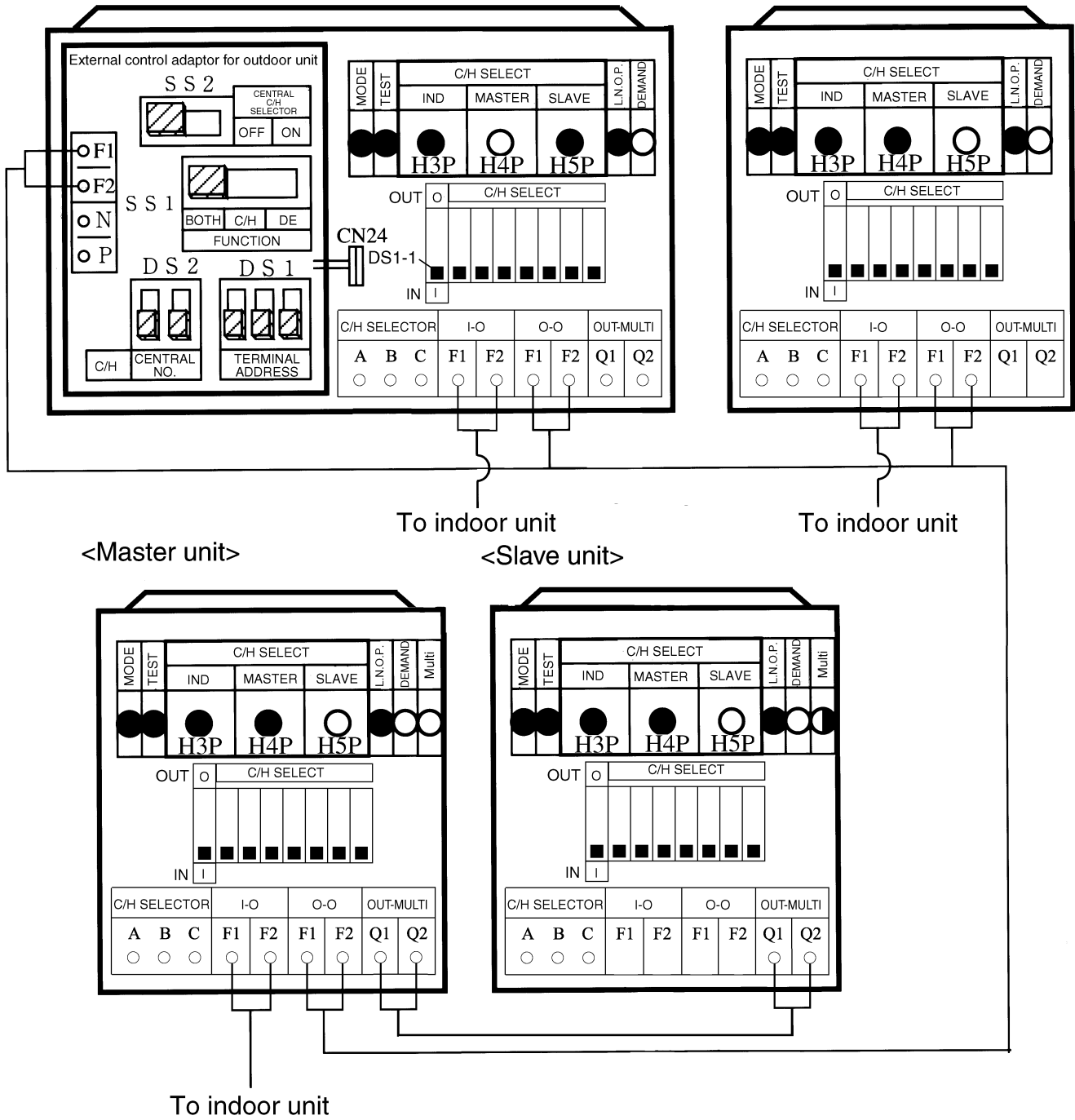

Multi outdoor units connection

- ◆ When multiple external control adaptors are used and cool / heat is selected for each external control adaptor, use “setting mode 2” and set DS1 and DS2 on the external control adaptors and the unified cool / heat address on the outdoor unit main PCB to the same address No. (For details, refer to the following page.)

④ Set Cool / Heat for More Than One Outdoor Unit System Simultaneously in Accordance with Unified Master Outdoor Unit by Cool / Heat Selector

- ◆ Install the external control adaptor for outdoor unit on either the outdoor-outdoor, indoor-outdoor transmission line.
- ◆ Mount the COOL/HEAT selector to the master outdoor unit for the unified control.
- ◆ Set the DS1-1 on the PCB of master outdoor unit to OUT.
- ◆ In setting mode 1, set the outdoor unit you want to give cool/heat selection permission to as the group master, and set the other outdoor units as group slave units.
- ◆ When multiple external control adaptors are used and cool / heat is selected for each external control adaptor, use “setting mode 2” and set DS1 and DS2 on the external control adaptors and the unified cool / heat address on the outdoor unit main PCB to the same address No. (For details, refer to the following page.)

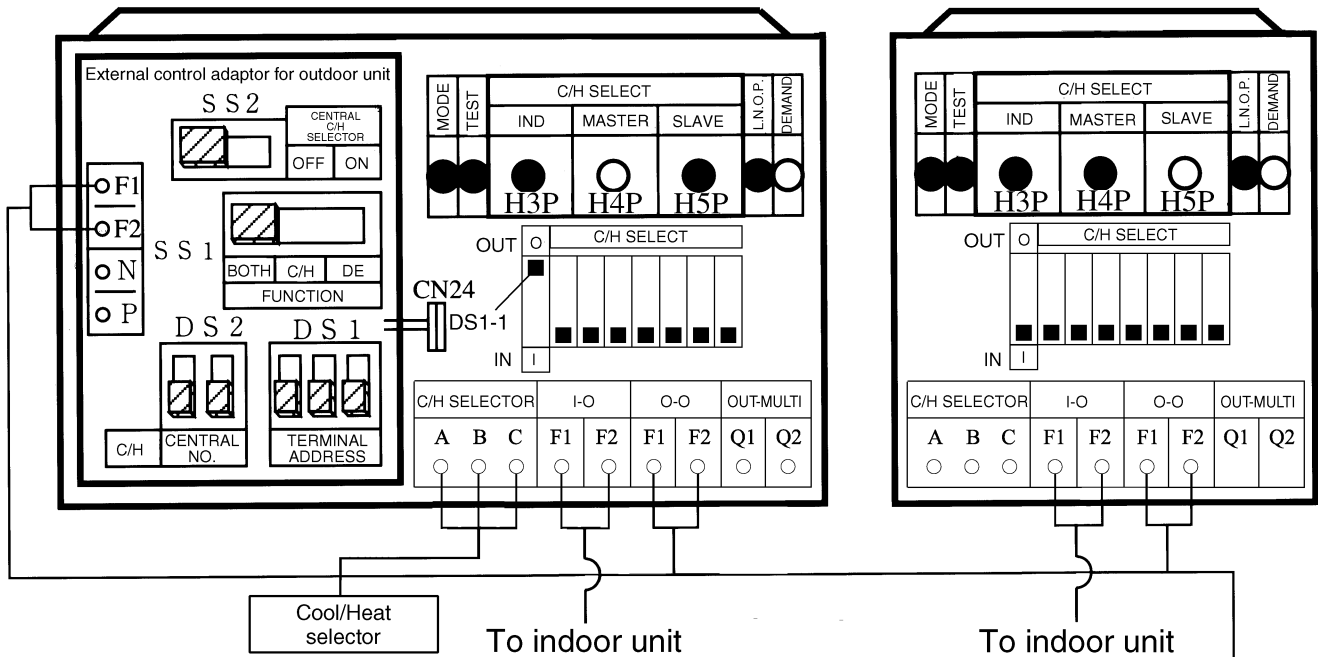

<Master unit>

<Slave unit>

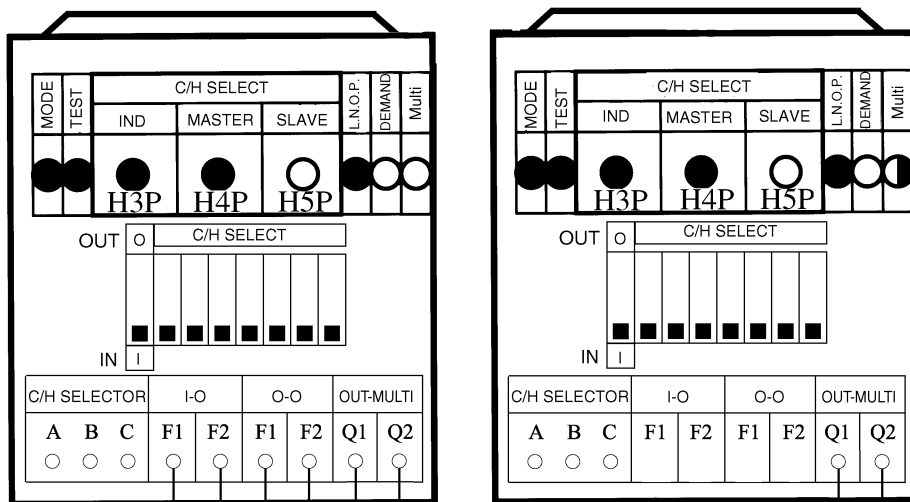

To indoor unit

Multi outdoor units connection

Supplementation on ③ and ④.

When switching cool/heat for each adaptor PCB with the use of more than one adaptor PCB, set the address of the external control adaptor for outdoor unit PCB DS1 and DS2 so that it matches the unified cool/heat address of outdoor unit main PCB.

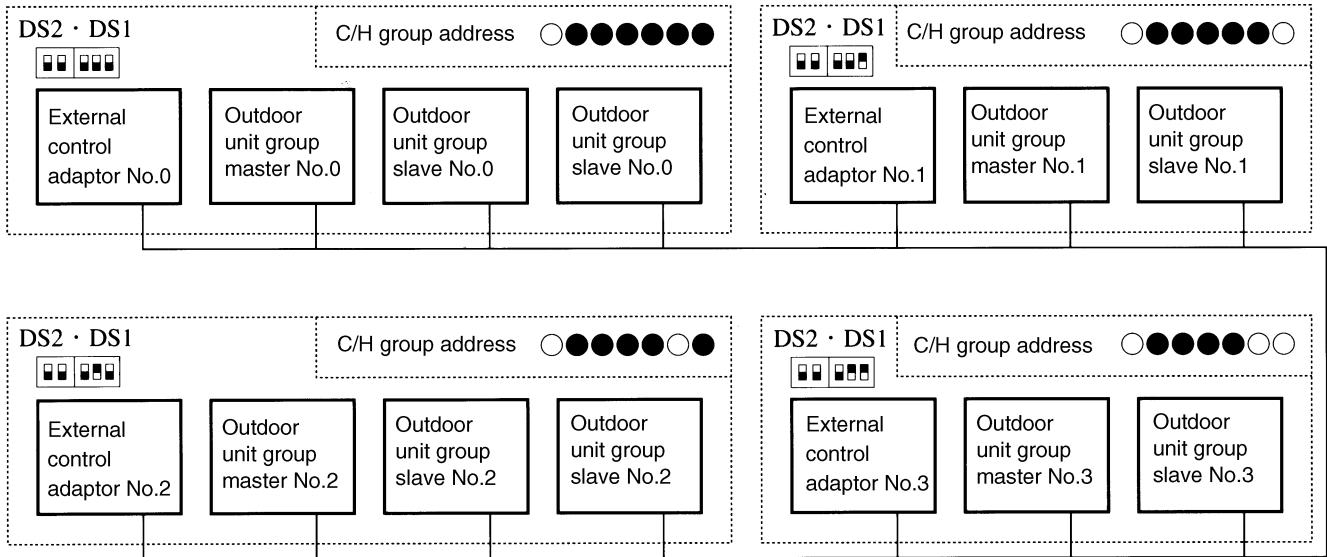

Address setting for ③ and ④ (Set lower 5 digits with binary number.) [No.0 to No.31]

| Address No. | Outdoor unit PCB LED Set with setting mode 2 | | External control adaptor for outdoor unit | |
|-------------|--|-----------------|---|-----|
| | DS2 | DS1 | DS2 | DS1 |
| No 0 | ○ ● | ● ● ● ● ● 0 | | |
| No 1 | ○ ● | ● ● ● ● ○ 1 | | |
| No 2 | ○ ● | ● ● ● ○ ● 2 | | |
| No 3 | ○ ● | ● ● ● ○ ○ 3 | | |
| No 4 | ○ ● | ● ● ○ ● ● 4 | | |
| } | } | } | } | } |
| No 30 | ○ ● | ● ● ● ● ○ 30 | | |
| No 31 | ○ ● | ○ ○ ○ ○ ○ 31 | | |

○ ON ● OFF Upper position (ON) lower position (OFF)
(The shaded part shows knob)

⑤ Set cool/heat at all outdoor unit systems simultaneously for each outdoor unit external control adaptor by using the central remote controller.

- ◆ Install the outdoor unit external control adaptor (optional accessory) onto the outdoor-outdoor, indoor-outdoor, or indoor-indoor transmission line.
- ◆ Use "setting mode 1" and set all outdoor units to SLAVE.
- ◆ Set the outdoor unit external control adaptor SS1 to BOTH (factory set) or C/H and set SS2 to ON.
- ◆ Use "setting mode 2" and set DS1 and DS2 on the outdoor unit external control adaptors and the unified heat/cool address on the outdoor unit main PCB to the same address. (The factory set addresses are all "0".)

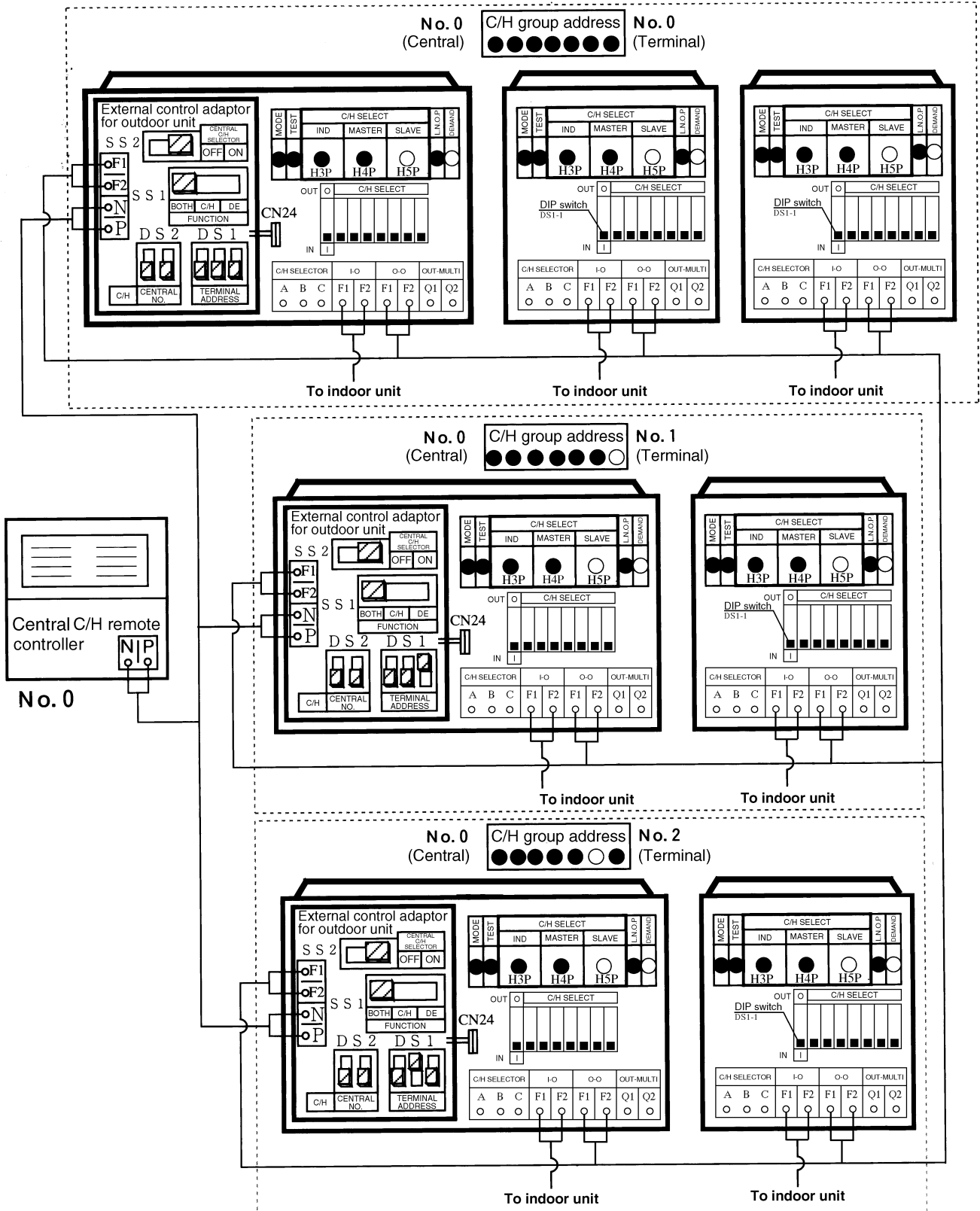

2.1.3 Cool/Heat Changeover Setting [For RQCEP Type]

● To use a cool/heat changeover remote controller

- ① Set the dip switch on the BS unit PCB (DS 1-1) according to the following before turning on the BS unit.
- ② Connect the cool/heat changeover remote controller to (A), (B) and (C) of the terminal strip X2M.

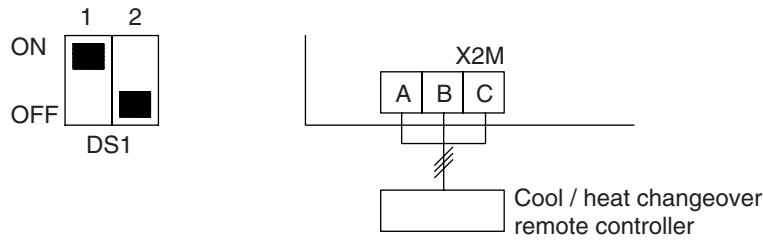

- Note:
- This setting is read by a micro-computer when the power is turned on.
 - Be sure to set the switch before turning on the power.
 - Be sure to close the EL. COMPO. BOX lid after setting.

● To use a cool/heat centralized remote controller

"External control adaptor for the outdoor unit" is required to use a cool/heat centralized remote controller.

- ① Set the dip switch on the BS unit PCB (DS 1-2) according to the following before turning on the BS unit.

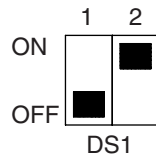

- ② Connect the connector of the "External control adaptor for the outdoor unit" to the connector (X2A) on the BS unit PCB (Refer to the installation manual and the installation guide for details of the installation).
- ③ Connect the terminals (F1, F2) of the external control adaptor for the outdoor unit to the terminals (F1, F2: indoor side) on the BS unit PCB (Refer to the figure below).

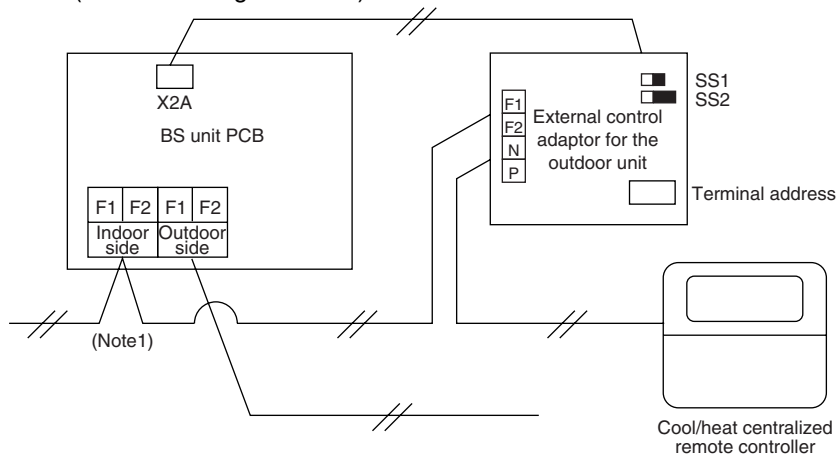

- ④ Set the external control adaptor for the outdoor unit according to the following:

- Set SS1 of the external control adaptor for the outdoor unit to "BOTH" or "C/H".
- Set SS2 of the external control adaptor for the outdoor unit to "ON".
- A unit No. of the cool/heat centralized remote controller can be set by setting the terminal address of the external control adaptor for the outdoor unit to 0-7.

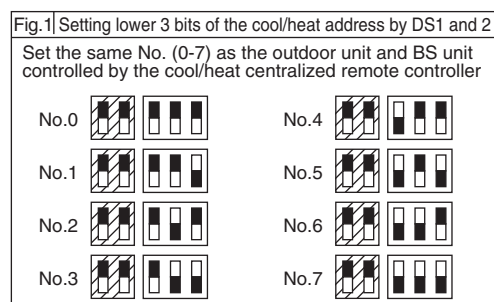
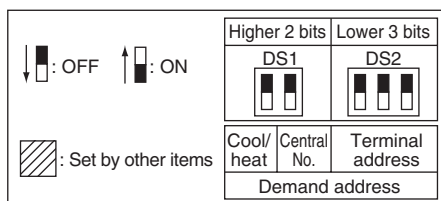

2.1.4 Setting of Low Noise Operation and Demand Operation

Setting of Low Noise Operation

By connecting the external contact input to the low noise input of the outdoor unit external control adaptor (optional), you can lower operating noise by 2-3 dB.

| Setting | Content |
|---------|--|
| Mode 1 | Set the outdoor unit fan to Step 6 or lower. |
| Mode 2 | Set the outdoor unit fan to Step 5 or lower. |
| Mode 3 | Set the outdoor unit fan to Step 4 or lower. |

A. When the low noise operation is carried out by external contact (with the use of the external control adaptor for outdoor unit)

1. Connect the external control adaptor, and short circuit the low noise terminals of the terminal strip (TeS1).
2. While in "Setting mode 2", set the setting condition for set item No. 12 (Setting of external low noise/demand operation) to "YES".
3. If necessary, while in "Setting mode 2", select the setting condition (i.e., "Mode 1", "Mode 2", or "Mode 3") for set item No. 25 (Setting of external low noise level).
4. If necessary, while in "Setting mode 2", set the setting condition for the set item No. 29 (Setting of capacity precedence) to "ON".
(If the condition is set to "ON", when the air-conditioning load reaches a high level, the low noise operation command will be ignored to put the system into normal operation mode.)

B. When the low noise operation is carried out automatically at night (The external control adaptor for outdoor unit is not required)

1. While in "Setting mode 2", select the setting condition (i.e., "Mode 1", "Mode 2", or "Mode 3") for set item No. 22 (Setting of nighttime low noise level).
2. If necessary, while in "Setting mode 2", select the setting condition (i.e., "20:00", "22:00", or "24:00") for set item No. 26 (Setting of start time of nighttime low noise operation).
(Use the start time as a guide since it is estimated according to outdoor temperatures.)
3. If necessary, while in "Setting mode 2", select the setting condition (i.e., "06:00", "07:00", or "08:00") for set item No. 27 (Setting of end time of nighttime low noise operation).
(Use the end time as a guide since it is estimated according to outdoor temperatures.)
4. If necessary, while in "Setting mode 2", set the setting condition for set item No. 29 (Setting of capacity precedence) to "ON".
(If the condition is set to "ON", when the air-conditioning load reaches a high level, the system will be put into normal operation mode even during nighttime.)

2.1.5 Setting of Demand Operation

By connecting the external contact input to the demand input of the outdoor unit external control adaptor (optional), the power consumption of unit operation can be saved suppressing the compressor operating condition.

| Setting content | | | Setting method | |
|-----------------|-----------|---|---|--|
| Set item | Condition | Content | External control adaptor | Outdoor unit PCB |
| Demand 1 | Mode 1 | The compressor operates at approx. 60% or less of rating. | Short circuit "1" and "C" on the terminal strip (TeS1). | Set item No. 32 to "Demand 1", and item No. 30 to "Level 1". |
| | Mode 2 | The compressor operates at approx. 70% or less of rating. | | Set item No. 32 to "Demand 1", and item No. 30 to "Level 2". |
| | Mode 3 | The compressor operates at approx. 80% or less of rating. | | Set item No. 32 to "Demand 1", and item No. 30 to "Level 3". |
| Demand 2 | — | The compressor operates at approx. 40% or less of rating. | Short circuit "2" and "C". | Set item No. 32 to "Demand 2". |
| Demand 3 | — | Forced thermostat OFF. | Short circuit "3" and "C". | — |

*: However the demand operation does not occur in the following operation modes.

- ① Startup control ② Oil return operation
- ③ Defrosting operation ④ Pump-down residual operation

A. When the demand operation is carried out by external contact (with the use of the external control adaptor for outdoor unit).

1. Connect the external control adaptor, and short circuit the low noise terminals of the terminal strip (TeS1).
2. While in "Setting mode 2", set the setting condition for set item No. 12 (Setting of external low noise/demand operation) to "YES".
3. If necessary, while in "Setting mode 2", select the set item No. 30 (Setting of Demand 1 level) and then set the setting condition to targeted mode.

B. When the normal demand operation is carried out. (Use of the external control adaptor for outdoor unit is not required.)

1. While in "Setting mode 2", make setting of the set item No. 32 (Setting of alternate demand) to "ON".
2. While in "Setting mode 2", select the set item No. 30 (Setting of Demand 1 level) and then set the setting condition to targeted mode.

2.1.6 Air Tight Test Procedure

After internal servicing is performed in the field, perform the air tight test. Fully open the electronic expansion valves of the outdoor unit and indoor unit, and turn on some of the solenoid valves.

[Operation procedure]

- ① With the system stopped, use "Setting mode 2" and set (A) Refrigerant recovery / vacuuming mode (setting item No. 21) to "ON".
All of the indoor unit and outdoor unit electronic expansion valves fully open and some of the solenoid valves turn on. (H2P blinks to indicate the test operation, and the remote controller displays "Test Operation" and "Under centralized control", thus prohibiting operation.)
- ② Close the stop valves on the gas side and liquid side, and perform an air tight test at 4.0 MPa.
- ③ Press the MODE button (BS1) to cancel "Setting mode 2".

<Caution>

Do not turn off the outdoor unit power during the air tight test.

(The solenoid valves will close and the outdoor unit air tight test will not be possible.)

2.1.7 Setting of Refrigerant Recovery Mode

When carrying out the refrigerant collection on site, fully open the respective expansion valve of indoor and outdoor units.

All indoor and outdoor unit's operation are prohibited.

[Operation procedure]

- ① In **setting mode 2** with units in stop mode, set "Refrigerant Recovery / Vacuuming mode" to ON. The respective expansion valve of indoor and outdoor units are fully opened and some of solenoid valves open. (H2P turns to display "TEST OPERATION" (blinks), "TEST OPERATION" and "UNDER CENTRALIZED CONTROL" are displayed on the remote controller, and the all indoor / outdoor unit operation is prohibited.
After setting, do not cancel "Setting Mode 2" until completion of refrigerant recovery operation.
- ② Collect the refrigerant using a refrigerant recovery unit. (See the instruction attached to the refrigerant recovery unit for more detail.)
- ③ Press Mode button "BS1" once and reset "Setting Mode 2".

2.1.8 Setting of Vacuuming Mode

In order to perform vacuuming operation on site, fully open the expansion valves of indoor and outdoor units and turn on some solenoid valves.

[Operating procedure]

- ① With **Setting Mode 2** while the unit stops, set "Refrigerant recovery / Vacuuming mode" to ON. The expansion valves of indoor and outdoor units fully open and some of solenoid valves open.
(H2P blinks to indicate the test operation, and the remote controller displays "Test Operation" and "Under centralized control", thus prohibiting operation.)
After setting, do not cancel "Setting Mode 2" until completion of Vacuuming operation.
- ② Use the vacuum pump to perform vacuuming operation.
- ③ Press Mode button "BS1" once and reset "Setting Mode 2".

2.1.9 Emergency Operation

If the compressor cannot operate, this control inhibits any applicable compressor or outdoor unit from operating to perform emergency operation only with the operative compressor or outdoor unit.

[Automatic backup operation]

With multi-outdoor-unit system, if a certain outdoor unit system malfunctions (i.e., the system stops and indoor unit remote controller displays the malfunction), by resetting the indoor unit remote controller, the applicable outdoor unit is inhibited from operating for 8 hours, thus making it possible to perform emergency operation automatically.

However, in the event any of the following malfunctions occurs, automatic backup operation can be performed.

Malfunctions under which automatic backup operation can be performed:

- E3, E4, E5, E7
- F3
- H7, H9
- J2, J3, J5, J6, J7, J9, JA, JC
- L1, L4, L5, L8, L9, LC
- U2, UJ

[Emergency operation with settings in service mode]

* "Inhibition of operation" is set with each outdoor unit.

Make the following settings with the master unit. (Setting with the slave unit becomes disabled.)

* Discriminate the operating status of the master unit / slave units through the following LED display.

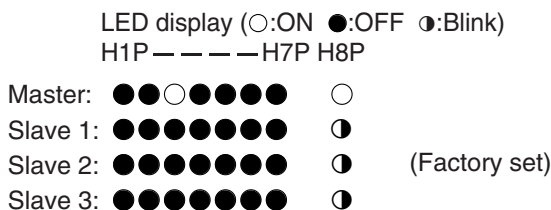

- In order to set the master unit to operation prohibition mode, set No. 38 of Setting mode 2 to "MASTER OPERATION PROHIBITION".

(Procedure)

- (1) Press and hold the MODE button (BS1) for a period of 5 seconds or more.
- (2) Press the SET button (BS2) 38 times.
- (3) Press the RETURN button (BS3) once.
- (4) Press the SET button (BS2) once.
- (5) Press the RETURN button (BS3) twice.
- (6) Press the MODE button (BS1) once.

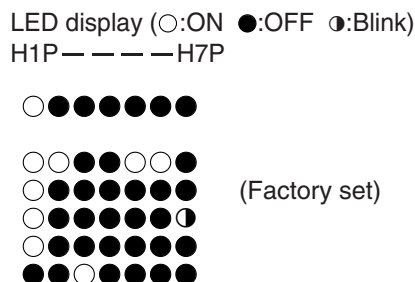

- In order to set the slave unit 1 to operation prohibition mode, set No. 39 of Setting mode 2 to "SLAVE 1 OPERATION PROHIBITION".

(Procedure)

- (1) Press and hold the MODE button (BS1) for a period of 5 seconds or more.
- (2) Press the SET button (BS2) 39 times.
- (3) Press the RETURN button (BS3) once.
- (4) Press the SET button (BS2) once.
- (5) Press the RETURN button (BS3) twice.
- (6) Press the MODE button (BS1) once.

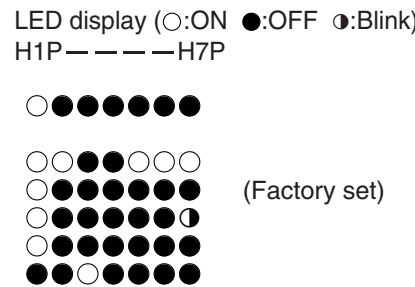

- In order to set the slave unit 2 to operation prohibition mode, set No. 39 of Setting mode 2 to "SLAVE 2 OPERATION PROHIBITION".

(Procedure)

- (1) Press and hold the MODE button (BS1) for a period of 5 seconds or more.
- (2) Press the SET button (BS2) 39 times.
- (3) Press the RETURN button (BS3) once.
- (4) Press the SET button (BS2) twice.
- (5) Press the RETURN button (BS3) twice.
- (6) Press the MODE button (BS1) once.

LED display (○:ON ●:OFF ◐:Blink)
H1P— — — —H7P



(Factory set)

- In order to set the slave unit 3 to operation prohibition mode, set No. 39 of Setting mode 2 to "SLAVE 3 OPERATION PROHIBITION".

(Procedure)

- (1) Press and hold the MODE button (BS1) for a period of 5 seconds or more.
- (2) Press the SET button (BS2) 40 times.
- (3) Press the RETURN button (BS3) once.
- (4) Press the SET button (BS2) once.
- (5) Press the RETURN button (BS3) twice.
- (6) Press the MODE button (BS1) once.

LED display (○:ON ●:OFF ◐:Blink)
H1P— — — —H7P



(Factory set)

*

- In the case of multi-outdoor-unit system, when the above "Inhibition of operation" is set, outdoor unit rotation is not functional.

Part 6

Troubleshooting

| | |
|--|-----|
| 1. Symptom-based Troubleshooting | 94 |
| 2. Troubleshooting by Remote Controller | 97 |
| 2.1 The INSPECTION / TEST Button..... | 97 |
| 2.2 Self-diagnosis by Wired Remote Controller | 98 |
| 2.3 Remote Controller Service Mode | 99 |
| 2.4 Test Run Mode..... | 102 |
| 2.5 Remote Controller Self-Diagnosis Function | 102 |
| 2.6 “E1” Outdoor Unit: PCB Defect | 110 |
| 2.7 “E2” Outdoor Unit: Actuation of High Pressure Switch..... | 111 |
| 2.8 “E3” Outdoor Unit: Actuation of High Pressure Switch..... | 112 |
| 2.9 “E4” Outdoor Unit: Actuation of Low Pressure Sensor..... | 114 |
| 2.10 “E5” Outdoor Unit: Inverter Compressor Motor Lock..... | 116 |
| 2.11 “E7” Outdoor Unit: Malfunction of Outdoor Unit Fan Motor | 118 |
| 2.12 “E9” Outdoor Unit: Malfunction of Electronic Expansion Valve Coil (Y1E~Y3E) | 121 |
| 2.13 “F3” Outdoor Unit: Abnormal Discharge Pipe Temperature..... | 123 |
| 2.14 “F4” Outdoor Unit: Humidity alarm | 125 |
| 2.15 “F9” Outdoor Unit : Malfunction of BS Unit Electronic Expansion Valve..... | 127 |
| 2.16 “H7” Outdoor Unit: Abnormal Outdoor Fan Motor Signal | 129 |
| 2.17 “H9” Outdoor Unit: Malfunction of Thermistor (R1T) for Outdoor Air..... | 131 |
| 2.18 “U3, U4, U5, U6, U7, U8, U9” Outdoor Unit: Malfunction of Outdoor unit Thermistor | 132 |
| 2.19 “U9” Outdoor Unit: Malfunction of High Pressure Sensor..... | 134 |
| 2.20 “U7” Outdoor Unit: Malfunction of Low Pressure Sensor | 136 |
| 2.21 “L1” Outdoor Unit: Malfunction of Inverter PCB | 138 |
| 2.22 “L4” Outdoor Unit: Malfunction of Inverter Radiating Fin Temperature Rise..... | 140 |
| 2.23 “L5” Outdoor Unit: Momentary Overcurrent of Inverter Compressor | 142 |
| 2.24 “L8” Outdoor Unit: Momentary Overcurrent of Inverter Compressor | 144 |
| 2.25 “L9” Outdoor Unit: Inverter Compressor Starting Failure | 146 |
| 2.26 “L7” Outdoor Unit: Malfunction of Transmission between Inverter and Main PCB | 149 |
| 2.27 “P1” Outdoor Unit: Inverter Over-Ripple Protection..... | 151 |
| 2.28 “P4” Outdoor Unit: Malfunction of Inverter Radiating Fin Temperature Rise Sensor | 153 |
| 2.29 “P6” Outdoor Unit: Faulty Field Setting after Replacing Main PCB or Faulty Combination of PCB..... | 154 |
| 2.30 “U1” Reverse Phase, Open Phase | 156 |
| 2.31 “U2” Outdoor Unit: Power Supply Insufficient or Instantaneous Failure..... | 157 |
| 2.32 “U3” Outdoor Unit: Check Operation is not Executed..... | 160 |
| 2.33 “U4” Malfunction of Transmission between Indoor Units and Outdoor Units | 162 |
| 2.34 “U7” Outdoor Unit: Transmission Failure (Across Outdoor Units) | 165 |

| | |
|--|-----|
| 2.35 “U3” Indoor Unit: Malfunction of Transmission between Main and Sub Remote Controllers | 172 |
| 2.36 “U3” Indoor Unit: Malfunction of Transmission between Indoor and Outdoor Units in the Same System | 173 |
| 2.37 “U3” Improper Combination of Indoor, BS and Outdoor Units, Indoor Units and Remote Controller | 174 |
| 2.38 “U4” Address Duplication of Centralized Controller | 182 |
| 2.39 “U5” Malfunction of Transmission between Centralized Controller and Indoor Unit | 183 |
| 2.40 “U6” System is not Set yet | 186 |
| 2.41 “U7” Malfunction of System, Refrigerant System Address Undefined ... | 187 |

1. Symptom-based Troubleshooting

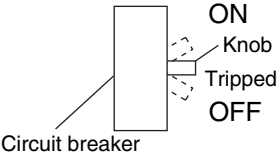
| | Symptom | Supposed Cause | Countermeasure | |
|--|--|--|--|--|
| 1 | The system does not start operation at all. | Blowout of fuse(s) | Turn Off the power supply and then replace the fuse(s). | |
| | | Cutout of breaker(s) | <ul style="list-style-type: none"> If the knob of any breaker is in its OFF position, turn ON the power supply. If the knob of any circuit breaker is in its tripped position, do not turn ON the power supply.  <p>The diagram shows a rectangular circuit breaker with a knob on the right side. The knob has three positions: 'ON' at the top, 'Tripped' in the middle, and 'OFF' at the bottom. A dashed line indicates the knob's movement between these positions. The label 'Circuit breaker' points to the main body of the device.</p> | |
| | | Power failure | After the power failure is reset, restart the system. | |
| 2 | The system starts operation but makes an immediate stop. | Blocked air inlet or outlet of indoor or outdoor unit | Remove obstacle(s). | |
| | | Clogged air filter(s) | Clean the air filter(s). | |
| 3 | The system does not cool or heat air well. | Blocked air inlet or outlet of indoor or outdoor unit | Remove obstacle(s). | |
| | | Clogged air filter(s) | Clean the air filter(s). | |
| | | Enclosed outdoor unit(s) | Remove the enclosure. | |
| | | Improper set temperature | Set the temperature to a proper degree. | |
| | | Airflow rate set to "LOW" | Set it to a proper airflow rate. | |
| | | Improper direction of air diffusion | Set it to a proper direction. | |
| | | Open window(s) or door(s) | Shut it tightly. | |
| | | [In cooling] Direct sunlight received | Hang curtains or shades on windows. | |
| | | [In cooling] Too many persons staying in a room | The model must be selected to match the air conditioning load. | |
| [In cooling] Too many heat sources (e.g. OA equipment) located in a room | | | | |
| 4 | The system does not operate. | The system stops and immediately restarts operation. | Normal operation. The system will automatically start operation after a lapse of five minutes. | |
| | | Pressing the TEMP ADJUST button immediately resets the system. | | |
| | | The remote controller displays "UNDER CENTRALIZED CONTROL", which blinks for a period of several seconds when the OPERATION button is depressed. | The system is controlled with centralized controller. Blinking display indicates that the system cannot be operated using the remote controller. | Operate the system using the COOL/HEAT centralized remote controller. |
| | | The system stops immediately after turning ON the power supply. | The system is in preparation mode of micro-computer operation. | Wait for a period of approximately one minute. |
| 5 | The system makes intermittent stops. | The remote controller displays malfunction codes "U4" and "U5", and the system stops but restarts after a lapse of several minutes. | The system stops due to an interruption in communication between units caused by electrical noises coming from equipment other than air conditioners. | Remove causes of electrical noises. If these causes are removed, the system will automatically restart operation. |
| 6 | COOL-HEAT selection is disabled. | The remote controller displays "UNDER CENTRALIZED CONTROL". | This remote controller has no option to select cooling operation. | Use a remote controller with option to select cooling operation. |
| | | The remote controller displays "UNDER CENTRALIZED CONTROL", and the COOL-HEAT selection remote controller is provided. | COOL-HEAT selection is made using the COOL-HEAT selection remote controller. | Use the COOL-HEAT selection remote controller to select cool or heat. |

| | Symptom | Supposed Cause | Countermeasure |
|----|---|--|---|
| 7 | The system conducts fan operation but not cooling or heating operation. | This symptom occurs immediately after turning ON the power supply. | The system is in preparation mode of operation. Wait for a period of approximately 10 minutes. |
| | | "UNDER CENTRALIZED CONTROL" is displayed on the remote controller and the cooling/heating operation stops. The operation switches to the air supply operation. | Even though, the cooling or heating operation is set, the air supply operation continues during thermal storage operation. "UNDER CENTRALIZED CONTROL" is displayed on the remote controller. Normal operation. |
| 8 | The airflow rate is not reproduced according to the setting. | Even pressing the AIRFLOW RATE SET button makes no changes in the airflow rate. | In heating operation, when the room temperature reaches the set degree, the outdoor unit will stop while the indoor unit is brought to fan LL operation so that no one gets cold air. Furthermore, if fan operation mode is selected when other indoor unit is in heating operation, the system will be brought to fan LL operation. Normal operation. |
| 9 | The airflow direction is not reproduced according to the setting. | The airflow direction is not corresponding to that displayed on the remote controller. The flap does not swing. | Automatic control Normal operation. |
| 10 | A white mist comes out from the system. | <Indoor unit> In cooling operation, the ambient humidity is high. (This indoor unit is installed in a place with much oil or dust.) | Uneven temperature distribution due to heavy stain of the inside of the indoor unit Clean the inside of the indoor unit. |
| | | <Indoor unit> Immediately after cooling operation stopping, the ambient temperature and humidity are low. | Hot gas (refrigerant) flown in the indoor unit results to be vapor from the unit. Normal operation. |
| | | <Indoor and outdoor units> After the completion of defrosting operation, the system is switched to heating operation. | Defrosted moisture turns to be vapor and comes out from the units. Normal operation. |

| | Symptom | Supposed Cause | Countermeasure | |
|----|--|--|--|--|
| 11 | The system produces sounds. | <Indoor unit> Immediately after turning ON the power supply, indoor unit produces "ringing" sounds. | These are operating sounds of the electronic expansion valve of the indoor unit. | Normal operation. This sound becomes low after a lapse of approximately one minute. |
| | | <Indoor and outdoor units> "Hissing" sounds are continuously produced while in cooling or defrosting operation. | These sounds are produced from gas (refrigerant) flowing respectively through the indoor and outdoor units. | Normal operation. |
| | | <Indoor and outdoor units> "Hissing" sounds are produced immediately after the startup or stop of the system, or the startup or stop of defrosting operation. | These sounds are produced when the gas (refrigerant) stops or changes flowing. | Normal operation. |
| | | <Indoor unit> Faint sounds are continuously produced while in cooling operation or after stopping the operation. | These sounds are produced from the drain discharge device in operation. | Normal operation. |
| | | <Indoor unit> "Creaking" sounds are produced while in heating operation or after stopping the operation. | These sounds are produced from resin parts expanding and contracting with temperature changes. | Normal operation. |
| | | <Indoor unit> Sounds like "trickling" or the like are produced from indoor units in the stopped state. | On VRV systems, these sounds are produced when other indoor units in operation. The reason is that the system runs in order to prevent oil or refrigerant from dwelling. | Normal operation. |
| | | <Outdoor unit> Pitch of operating sounds changes. | The reason is that the compressor changes the operating frequency. | Normal operation. |
| 12 | Dust comes out from the system. | Dust comes out from the system when it restarts after the stop for an extended period of time. | Dust, which has deposited on the inside of indoor unit, is blown out from the system. | Normal operation. |
| 13 | Odors come out from the system. | In operation | Odors of room, cigarettes or else adsorbed to the inside of indoor unit are blown out. | The inside of the indoor unit should be cleaned. |
| 14 | Outdoor unit fan does not rotate. | In operation | The reason is that fan revolutions are controlled to put the operation to the optimum state. | Normal operation. |
| 15 | LCD display "88" appears on the remote controller. | Immediately after turning ON the power supply | The reason is that the system is checking to be sure the remote controller is normal. | Normal operation. This code is displayed for a period of approximately one minute at maximum. |
| 16 | The outdoor unit compressor or the outdoor unit fan does not stop. | After stopping operation | It stops in order to prevent oil or refrigerant from dwelling. | Normal operation. It stops after a lapse of approximately 5 to 10 minutes. |
| 17 | The outdoor gets hot. | While stopping operation | The reason is that the compressor is warmed up to provide smooth startup of the system. | Normal operation. |
| 18 | Hot air comes out from the system even though it stops. | Hot air is felt while the system stops. | On VRV systems, small quantity of refrigerant is fed to indoor units in the stopped state when other indoor units are in operation. | Normal operation. |
| 19 | The system does not cool air well. | The system is in dry operation. | The reason is that the dry operation serves not to reduce the room temperature where possible. | Change the system to cooling operation. |

2. Troubleshooting by Remote Controller

2.1 The INSPECTION / TEST Button

The following modes can be selected by using the [Inspection/Test Operation] button on the remote control.

On power-up, the message "Connection under check. Please wait for a moment" will be displayed on the remote controller screen. Then that message will disappear and the basic screen will be displayed. To access a mode from the basic screen, refer to the figure below. When any of the operation buttons is pressed, the backlight will come on and remains lit for about 30 seconds. Be sure to press a button while the backlight is on (this does not apply to the On/Off button.)

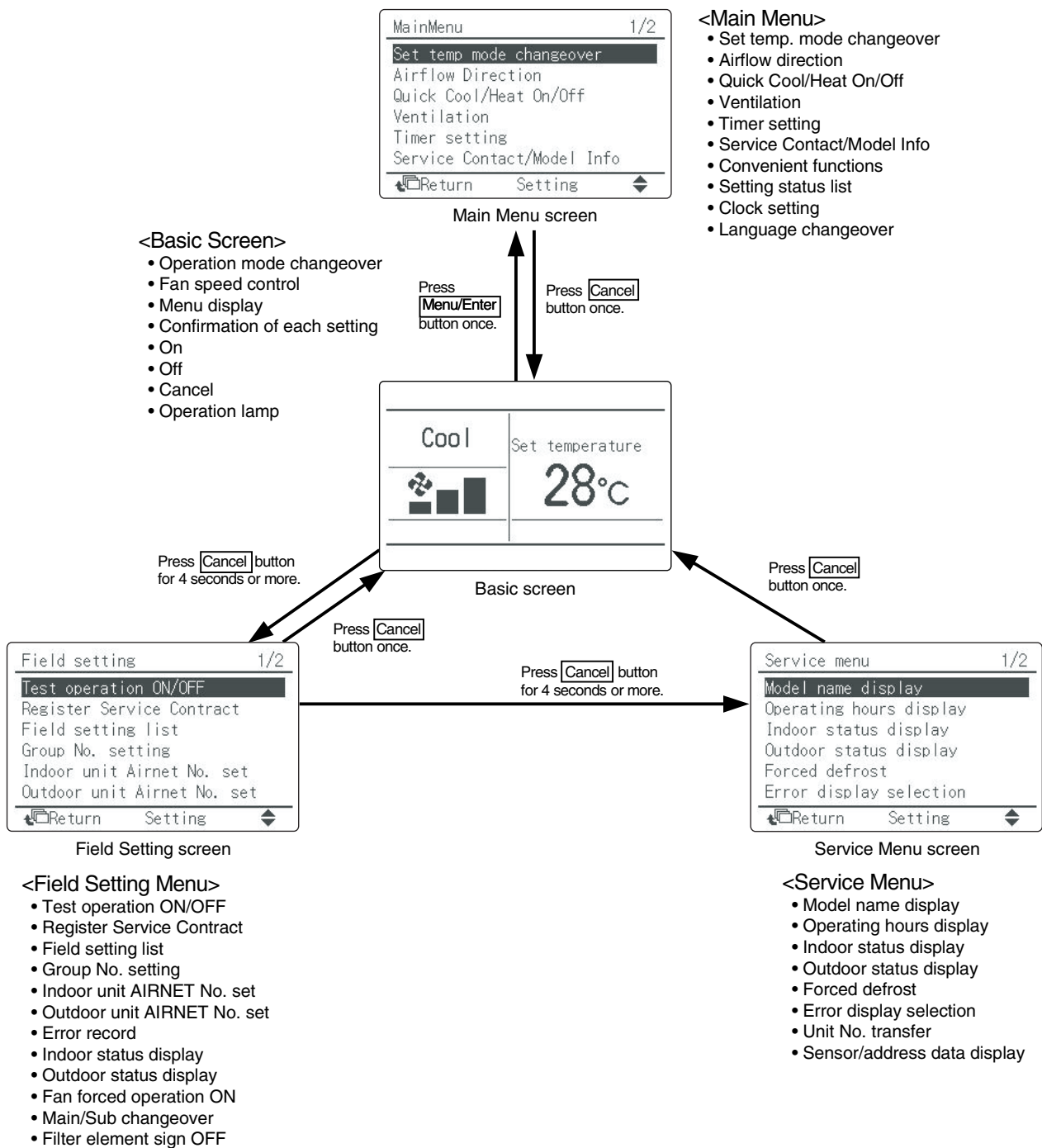

2.2 Self-diagnosis by Wired Remote Controller

Explanation

The following will be displayed on the screen when a malfunction (or a warning) occurs during operation.

Check the malfunction code and take the corrective action specified for the particular model.

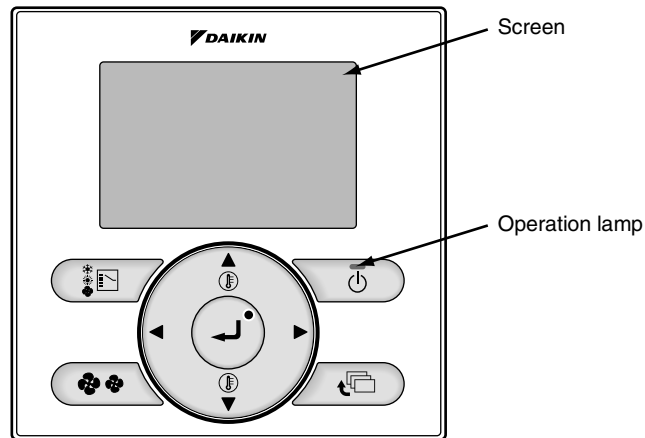

(1) Checking a malfunction or warning

| | Operation Status | Display |
|-------------------|-------------------------------------|--|
| Abnormal shutdown | The system stops operating. | <p>The operation lamp (green) starts to blink. The message "Malfunction: Press Menu button" will appear and blink at the bottom of the screen.</p> |
| Warning | The system continues its operation. | <p>The operation lamp (green) remains on. The message "Warning: Press Menu button" will appear and blink at the bottom of the screen.</p> |

2.3 Remote Controller Service Mode

Operating the **CHECK/TEST** button on the remote controller will make it possible to obtain "service data" and change "service setting" while in service mode.

How to Enter the Service Mode

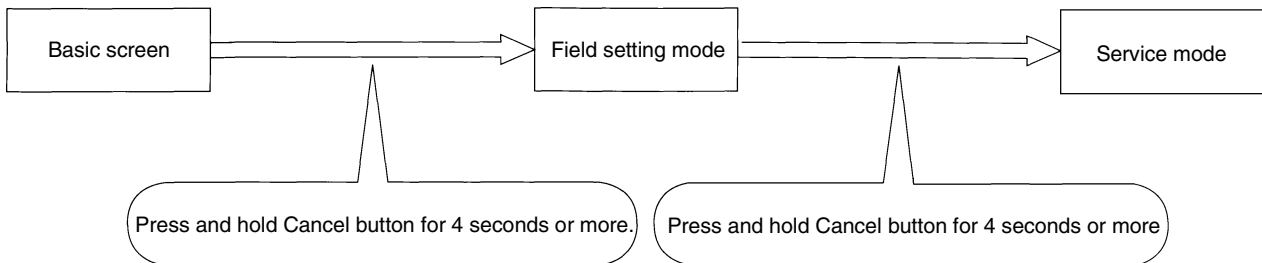

Service Mode Operation Method

1. Select the mode No.

Select the desired item from the Service menu, and then press Menu/Enter button.

2. Select the Item 2.

Select the desired Unit No. using the ▲/▼ (Up/Down) buttons. The corresponding data will be displayed.

For details, refer to the table in next page.

| Service Menu | Item 2 | Remarks | |
|---------------------------------|-------------------------------|--|--|
| 1. Model Name Display | 1. Unit No. | Select the Unit No. you want to check. | |
| | 2. Indoor unit | | |
| | 3. Outdoor unit | | |
| 2. Operating Hours Display | 1. Unit No. | Select the Unit No. you want to check. | |
| | 2. Indoor unit operating time | All of these are displayed in hours. | |
| | 3. Indoor fan operation | | |
| | 4. Indoor unit energized time | | |
| | 5. Outdoor operating time | | |
| | 6. Outdoor fan 1 operation | | |
| | 7. Outdoor fan 2 operation | | |
| | 8. Outdoor comp. 1 operation | | |
| | 9. Outdoor comp. 2 operation | | |
| 3. Indoor Status Display 1/2 | 1. Unit No. | | Select the Unit No. you want to check. |
| | 2. FAN | Tap, speed (rpm) | |
| | 3. FLAP | Swing, fixed | |
| | 4. Speed | Fan speed (rpm) | |
| | 5. EV | Degree that electronic expansion valve is open (pls) | |
| | 6. MP | Drain pump ON/OFF | |
| | 7. 52H | Electric heater ON/OFF | |
| | 8. Hu | Humidifier ON/OFF | |
| | 9. Anti-freezing | Anti-freezing control ON/OFF | |
| 3. Indoor Status Display 2/2 | 1. Unit No. | Select the Unit No. you want to check. | |
| | | SkyAir | VRV |
| | 2. Th1 | Suction air thermistor | Suction air thermistor |
| | 3. Th2 | Heat exchanger thermistor | Heat exchanger liquid pipe thermistor |
| | 4. Th3 | — | Heat exchanger gas pipe thermistor |
| | 5. Th4 | Discharge air thermistor | Discharge air thermistor |
| | 6. Th5 | — | — |
| | 7. Th6 | — | — |
| 4. Outdoor Status Display | 1. Unit No. | Select the Unit No. you want to check. | |
| | 2. FAN Tap 1 | Fan tap | |
| | 3. COMP | Compressor power supply frequency (Hz) | |
| | 4. EV1 | Degree that electronic expansion valve is open (pls) | |
| | 5. SV1 | Solenoid valve ON/OFF | |
| | | SkyAir | VRV |
| | 6. Th1 | Outdoor air thermistor | — |
| | 7. Th2 | Heat exchanger thermistor | — |
| | 8. Th3 | Discharge pipe thermistor | — |
| 5. Forced Defrost (SkyAir only) | 1. Forced defrost ON | Enables the forced defrost operation. | |
| | 2. Forced defrost OFF | Disables the forced defrost operation. | |

| Service Menu | Item 2 | Remarks |
|----------------------------|--|---|
| 6. Error Display Selection | 1. Warning display ON | Displays a warning on the screen if an error occurs. |
| | 2. Warning display OFF | No warning is displayed. |
| | 3. Error display ON | Displays the error on the screen. |
| | 4. Error display OFF | Displays neither errors nor warnings. |
| 7. Unit No. Transfer | 1. Current Unit No. | A unit No. can be transferred to another. |
| | 2. Transfer Unit No. | |
| 8. Sensor Address Display | ○ Unit No.: 0 - 15 | Select the Unit No. you want to check. |
| | ○ Code 0: 1: 2: 3: 4: 5: 6: 7: 8: 9: | Remote controller thermistor (°C) Suction air thermistor (°C) Heat exchanger liquid pipe thermistor (°C) Heat exchanger gas thermistor (°C) Indoor unit address No. Outdoor unit address No. BS unit address No. Zone control address No. Cooling/Heating batch address No. Demand/low-noise address No. |
| | ○ Data | The corresponding data will be displayed, based on the Unit No. and Code selected. |

2.4 Test Run Mode

Operating the **INSPECTION/TEST** button on the remote controller will make it possible to put the system into test run mode.

(1) Test run mode setting

The test run mode setting can be made by conducting the following operation.

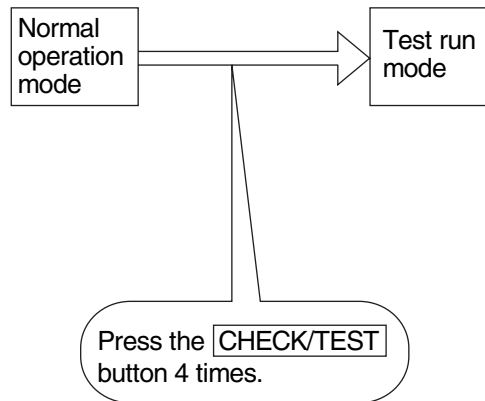

Press the **RUN/STOP** button after the completion of test run mode setting, and a test run starts.

(The remote controller will display "TEST RUN" on it.)

2.5 Remote Controller Self-Diagnosis Function

The following will be displayed on the screen when a malfunction (or a warning) occurs during operation.

Check the malfunction code and take the corrective action specified for the particular model.

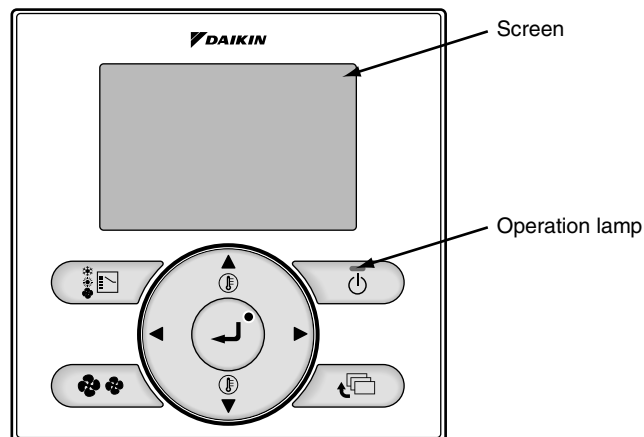

(1) Checking a malfunction or warning

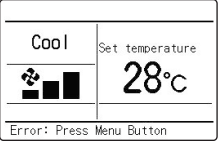
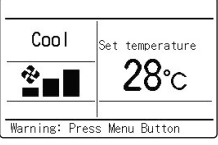
| | Operation Status | Display | |
|-------------------|-------------------------------------|---|---|
| Abnormal shutdown | The system stops operating. | The operation lamp (green) starts to blink. The message "Malfunction: Press Menu button" will appear and blink at the bottom of the screen. |  |
| Warning | The system continues its operation. | The operation lamp (green) remains on. The message "Warning: Press Menu button" will appear and blink at the bottom of the screen. |  |

(2) Taking corrective action

- Press the Menu/Enter button to check the malfunction code.



- Take the corrective action specific to the model.

| | |
|--|--------------------------|
| Error code:A1 | — Malfunction code |
| Contact address 0123-456-789 | |
| Indoor Unit FXMQ40PVE Outdoor Unit RWEYQ10PY1 | — Applicable model names |
| Return | |

○: ON ●: OFF ◐: Blink

| | Malfunction code | Operation lamp | Malfunction contents | Page Referred |
|--|------------------|---|--|---------------|
| Outdoor Unit | E1 | ◐ | PCB defect | 110 |
| | E2 | ◐ | Actuation of high pressure switch | 111 |
| | E3 | ◐ | Actuation of high pressure switch | 112 |
| | E4 | ◐ | Actuation of low pressure sensor | 114 |
| | E5 | ◐ | Inverter compressor motor lock | 116 |
| | E7 | ◐ | Malfunction of outdoor unit fan motor | 118 |
| | E9 | ◐ | Malfunction of moving part of electronic expansion valve (Y1E ~ Y5E) | 121 |
| | F3 | ◐ | Abnormal discharge pipe temperature | 123 |
| | F4 | ◐ | Humidity alarm | 125 |
| | F9 | ◐ | Malfunction of BS unit electronic expansion valve | 127 |
| | H7 | ◐ | Abnormal outdoor fan motor signal | 129 |
| | H9 | ◐ | Malfunction of thermistor (R1T) for outdoor air | 131 |
| | J3 | ◐ | Malfunction of discharge pipe thermistor (R31T, R32T, R33T) | 132 |
| | J4 | ◐ | Malfunction of temperature sensor for heat exchanger gas (R2T or R11T) | 132 |
| | J5 | ◐ | Malfunction of thermistor (R8T or R10T) for suction pipe | 132 |
| | J6 | ◐ | Malfunction of thermistor (R4T or R12T) for outdoor unit heat exchanger | 132 |
| | J7 | ◐ | Malfunction of liquid pipe thermistor 1 (R6T, R9T or R14T) | 132 |
| | J8 | ◐ | Malfunction of liquid pipe thermistor 2 (R7T or R15T) | 132 |
| | J9 | ◐ | Malfunction of subcooling heat exchanger gas pipe thermistor (R5T or R13T) | 132 |
| | JA | ◐ | Malfunction of high pressure sensor | 134 |
| | JC | ◐ | Malfunction of low pressure sensor | 136 |
| | L1 | ◐ | Malfunction of inverter PCB | 138 |
| | L4 | ◐ | Malfunction of inverter radiating fin temperature rise | 140 |
| | L5 | ◐ | Momentary overcurrent of inverter compressor | 142 |
| L8 | ◐ | Momentary overcurrent of inverter compressor | 144 | |
| L9 | ◐ | Inverter compressor starting failure | 146 | |
| Outdoor Unit | LA | ◐ | Malfunction of power unit | — |
| | LC | ◐ | Malfunction of transmission between inverter and control PCB | 149 |
| | P1 | ◐ | Inverter over-ripple protection | 151 |
| | P4 | ◐ | Malfunction of inverter radiating fin temperature rise sensor | 153 |
| | PJ | ◐ | Faulty field setting after replacing main PCB or faulty combination of PCB | 154 |
| System | U1 | ◐ | Reverse phase, open phase | 156 |
| | U2 | ◐ | Power supply insufficient or instantaneous failure | 157 |
| | U3 | ◐ | Check operation not executed | 160 |
| | U3 | ○ | Check operation is not completed. | 160 |
| | U4 | ◐ | Malfunction of transmission between indoor units and outdoor units | 162 |
| | U7 | ◐ | Transmission failure (Across outdoor units) | 165 |
| | U8 | ◐ | Malfunction of transmission between main and sub remote controllers | 172 |
| | U9 | ◐ | Malfunction of transmission between indoor and outdoor units in the same system | 173 |
| | UA | ◐ | Improper combination of indoor and outdoor units, indoor units and remote controller | 174 |
| | UC | ○ | Address duplication of centralized controller | 182 |
| | UE | ◐ | Malfunction of transmission between centralized controller and indoor unit | 183 |
| UF | ◐ | System is not set yet | 186 | |
| UH | ◐ | Malfunction of system, refrigerant system address undefined | 187 | |
| Centralized Remote Controller and Schedule Timer | M1 | ○ or ● | PCB defect | — |
| | M8 | ○ or ● | Malfunction of transmission between optional controllers for centralized control | — |
| | MA | ○ or ● | Improper combination of optional controllers for centralized control | — |
| | MC | ○ or ● | Address duplication, improper setting | — |

○: ON ●: OFF ◐: Blink

| | Malfunction code | Operation lamp | Malfunction contents | Page Referred |
|--------------------------|------------------|----------------|---|---------------|
| Heat Reclaim Ventilation | 64 | ○ | Indoor unit's air thermistor error | — |
| | 65 | ○ | Outside air thermistor error | — |
| | 6A | ○ | Damper system alarm | — |
| | 6A | ● | Damper system + thermistor error | — |
| | 6F | ○ | Malfunction of simple remote controller | — |
| | 6H | ○ | Malfunction of door switch or connector | — |
| | 94 | ◐ | Internal transmission error | — |

 The system operates for malfunction codes indicated in black squares, however, be sure to check and repair.

Malfunction code indication by outdoor unit PCB

<Monitor mode>

To enter the monitor mode, push the **MODE (BS1)** button when in "Setting mode 1".

* Refer to Page 78 for Monitor mode.

<Selection of setting item>

Push the **SET (BS2)** button and set the LED display to a setting item.

* Refer to Page 78 for Monitor mode.

<Confirmation of malfunction 1>

Push the **RETURN (BS3)** button once to display "First digit" of malfunction code.

<Confirmation of malfunction 2>

Push the **SET (BS2)** button once to display "Second digit" of malfunction code.

<Confirmation of malfunction 3>

Push the **SET (BS2)** button once to display "malfunction location".

<Confirmation of malfunction 4>

Push the **SET (BS2)** button once to display "master or slave 1 or slave 2" and "malfunction location".

Push the **RETURN (BS3)** button and switches to the initial status of "Monitor mode".

* Push the **MODE (BS1)** button and returns to "Setting mode 1".

Detail description on next page.

| Malfunctions | | Malfunction code | | |
|---|--|-------------------|--|----|
| Description of malfunction | Description of malfunction (PGF) | Remote controller | | |
| PCB malfunction | PCB malfunction | E1 | | |
| | Faulty PCB | | | |
| Abnormal discharge pressure | HPS activated | E2 | | |
| Abnormal discharge pressure | HPS activated | E3 | | |
| Abnormal suction pressure | Pe malfunction | E4 | | |
| Compressor lock | INV compressor lock detected | E5 | | |
| Overload, overcurrent and abnormal lock of outdoor unit fan motor | Instantaneous overcurrent of 1DC fan motor | E7 | | |
| | 1DC fan motor lock detected | | | |
| | Fan 1 IPM faulty protection detected | | | |
| | Instantaneous overcurrent of 2DC fan motor | | | |
| | 2DC fan motor lock detected | | | |
| Electronic expansion valve malfunction | EVT (subcool heat exchanger) | E9 | | |
| | EVM (main) | | | |
| | EVJ (refrigerant charging) | | | |
| Positioning signal malfunction of outdoor unit fan motor | 1DC fan motor positioning signal malfunction | H7 | | |
| | 2DC fan motor positioning signal malfunction | | | |
| Abnormal outdoor temperature | Ta sensor malfunction (short-circuited or open) | H9 | | |
| Abnormal discharge pipe temperature | Td malfunction | F3 | | |
| Abnormal humidity | Humidity alarm | F4 | | |
| | BS unit electronic expansion valve malfunction | | | |
| | BS EVH disconnected (Y4E) | | | |
| | BS EVL disconnected (Y5E) | | | |
| | BS EVHS disconnected (Y2E) | | | |
| BS unit electronic expansion valve malfunction | BS EVLS disconnected (Y3E) | F9 | | |
| | BS EVSC disconnected (Y1E) | | | |
| | Discharge pipe temperature sensor malfunction | | Tdi sensor malfunction (R31T) | J3 |
| | | | Tds1 sensor malfunction (short-circuited) (R32T) | |
| | | | Tds2 sensor malfunction (short-circuited) (R33T) | |
| Heat exchanger gas temperature sensor malfunction | Tg sensor malfunction (R2T, R11T) | J4 | | |
| Suction pipe temperature sensor malfunction | TsA sensor malfunction (short-circuited) (R8T, R10T) | J5 | | |
| Heat exchanger temperature sensor malfunction | Tb sensor malfunction (R4T, R12T) | J6 | | |
| Liquid pipe temperature sensor malfunction | Tsc sensor malfunction (R6T, R14T) | J7 | | |
| | TL sensor malfunction (R9T) | | | |
| Heat exchanger liquid pipe temperature sensor malfunction | Tf sensor malfunction (R7T, R15T) | J8 | | |
| Subcool heat exchanger temperature sensor malfunction | Tsh sensor malfunction (R5T, R13T) | J9 | | |
| Discharge pressure sensor malfunction | Pc sensor malfunction (S1NPH) | JA | | |
| Suction pressure sensor malfunction | Pe sensor malfunction (S1NPL) | JC | | |
| INV PCB malfunction | Faulty IPM | L1 | | |
| | Current sensor failure confirmation 1 | | | |
| | Current sensor failure confirmation 2 | | | |
| | IGBT malfunction | | | |
| Rise in INV radiation fin temperature | Overheat of INV radiation fin temperature | L4 | | |
| DC output overcurrent | Instantaneous overcurrent of INV | L5 | | |
| | IGBT malfunction | | | |
| Electronic thermal | Electronic thermal 1 | L8 | | |
| | Electronic thermal 2 | | | |
| | Loss of synchronization | | | |
| | Speed degradation after startup | | | |
| | Thunder detected | | | |
| Stall prevention (time limit) | Stall prevention (increased current) | L9 | | |
| | Stall prevention (startup failure) | | | |
| | Abnormal starting waveform | | | |
| | Loss of synchronization | | | |
| INV transmission malfunction | INV transmission data malfunction | LC | | |
| | INV transmission malfunction | | | |

○ : ON
 ◐ : Blink
 ● : OFF

○: ON ●: OFF ◐: Blink

| Malfunction code | Confirmation of malfunction 1 (Check 1) | | | | | | | Confirmation of malfunction 2 (Check 2) | | | | | | | Confirmation of malfunction 3 (Check 3) | | | | | | | Confirmation of malfunction 4 (Check 4) | | | | | | |
|------------------|---|-----|-----|-----|-----|-----|-----|---|-----|-----|-----|-----|-----|-----|---|-----|-----|-----|-----|-----|-----|---|-----|-----|-----|-----|-----|-----|
| | H1P | H2P | H3P | H4P | H5P | H6P | H7P | H1P | H2P | H3P | H4P | H5P | H6P | H7P | H1P | H2P | H3P | H4P | H5P | H6P | H7P | H1P | H2P | H3P | H4P | H5P | H6P | H7P |
| E1 | ○ | | | ● | ● | ◐ | ◐ | ◐ | | | ● | ● | ● | ◐ | ◐ | | | ● | ● | ● | ● | ◐ | | | ● | ● | ◐ | ◐ |
| E2 | | | | | | | | | | | | | | | | | | | | | | | | | | | | |
| E3 | | | | | | | | | | | ● | ● | ◐ | ◐ | ◐ | | | ● | ● | ● | ● | ◐ | | | ● | ● | | |
| E4 | | | | | | | | | | | ● | ◐ | ● | ● | ◐ | | | ● | ● | ● | ● | ◐ | | | ● | ● | | |
| E5 | | | | | | | | | | | ● | ◐ | ● | ◐ | ◐ | | | ● | ● | ● | ● | ◐ | | | ● | ● | | |
| E7 | | | | | | | | | | | ● | ◐ | ◐ | ◐ | ◐ | | | ● | ● | ● | ● | ◐ | | | ● | ● | | |
| E9 | | | | | | | | | | | ● | ● | ● | ◐ | ◐ | | | ● | ● | ● | ● | ◐ | | | ● | ● | | |
| | | | | | | | | | | | ● | ● | ● | ◐ | ◐ | | | ● | ● | ● | ● | ◐ | | | ● | ● | | |
| | | | | | | | | | | | ● | ● | ● | ◐ | ◐ | | | ● | ● | ● | ● | ◐ | | | ● | ● | | |
| | | | | | | | | | | | ● | ● | ● | ◐ | ◐ | | | ● | ● | ● | ● | ◐ | | | ● | ● | | |
| H7 | ◐ | | | ● | ◐ | ● | ● | ◐ | | | ● | ◐ | ◐ | ◐ | ◐ | | | ● | ● | ● | ● | ◐ | | | ● | ● | | |
| H9 | | | | | | | | | | ◐ | ● | ● | ◐ | ◐ | | | ● | ● | ● | ● | ◐ | | | ● | ● | | | |
| F3 | ◐ | | | ● | ◐ | ● | ◐ | ◐ | | | ● | ● | ◐ | ◐ | ◐ | | | ● | ● | ● | ● | ◐ | | | ● | ● | | |
| F4 | | | | | | | | | | | ◐ | ● | ● | ◐ | ◐ | | | ● | ● | ● | ● | ◐ | | | ● | ● | | |
| F9 | | | | | | | | | | | ◐ | ● | ● | ◐ | ◐ | | | ● | ● | ● | ● | ◐ | | | ● | ● | ◐ | ◐ |
| | | | | | | | | | | | ◐ | ● | ● | ◐ | ◐ | | | ● | ● | ● | ● | ◐ | | | ● | ● | ◐ | ◐ |
| | | | | | | | | | | | ◐ | ● | ● | ◐ | ◐ | | | ● | ● | ● | ● | ◐ | | | ● | ● | ◐ | ◐ |
| | | | | | | | | | | | ◐ | ● | ● | ◐ | ◐ | | | ● | ● | ● | ● | ◐ | | | ● | ● | ◐ | ◐ |
| J3 | ◐ | | | ● | ◐ | ◐ | ● | ◐ | | | ● | ● | ◐ | ◐ | ◐ | | | ● | ● | ● | ● | ◐ | | | ● | ● | | |
| J4 | | | | | | | | | | ● | ◐ | ● | ● | ◐ | | | ● | ● | ● | ● | ◐ | | | ● | ● | | | |
| J5 | | | | | | | | | | ● | ◐ | ● | ◐ | ◐ | | | ● | ● | ● | ● | ◐ | | | ● | ● | | | |
| J6 | | | | | | | | | | ● | ◐ | ◐ | ● | ◐ | | | ● | ● | ● | ● | ◐ | | | ● | ● | | | |
| J7 | | | | | | | | | | ● | ◐ | ◐ | ◐ | ◐ | | | ● | ● | ● | ● | ◐ | | | ● | ● | | | |
| J8 | | | | | | | | | | ◐ | ● | ● | ● | ◐ | | | ● | ● | ● | ● | ◐ | | | ● | ● | | | |
| J9 | | | | | | | | | | ◐ | ● | ● | ◐ | ◐ | | | ● | ● | ● | ● | ◐ | | | ● | ● | | | |
| JA | | | | | | | | | | ◐ | ● | ◐ | ● | ◐ | | | ● | ● | ● | ● | ◐ | | | ● | ● | | | |
| JC | | | | | | | | | | ◐ | ◐ | ◐ | ● | ◐ | | | ● | ● | ● | ● | ◐ | | | ● | ● | | | |
| L1 | ◐ | | | ● | ◐ | ◐ | ◐ | ◐ | | | ● | ● | ● | ◐ | ◐ | | | ● | ● | ● | ● | ◐ | | | ● | ● | | |
| L4 | | | | | | | | | | | ● | ◐ | ● | ● | ◐ | | | ● | ● | ● | ● | ◐ | | | ● | ● | | |
| | | | | | | | | | | | ● | ◐ | ● | ◐ | ◐ | | | ● | ● | ● | ● | ◐ | | | ● | ● | | |
| | | | | | | | | | | | ● | ◐ | ● | ◐ | ◐ | | | ● | ● | ● | ● | ◐ | | | ● | ● | | |
| | | | | | | | | | | | ● | ◐ | ● | ◐ | ◐ | | | ● | ● | ● | ● | ◐ | | | ● | ● | | |
| L8 | | | | | | | | | | ◐ | ● | ● | ● | ◐ | | | ● | ● | ● | ● | ◐ | | | ● | ● | | | |
| L9 | | | | | | | | | | ◐ | ● | ● | ◐ | ◐ | | | ● | ● | ● | ● | ◐ | | | ● | ● | | | |
| LC | | | | | | | | | | ◐ | ◐ | ● | ● | ◐ | | | ● | ● | ● | ● | ◐ | | | ● | ● | | | |

Display of contents of malfunction (first digit)

Display of contents of malfunction (second digit)

Display 1 of malfunction in detail

Display 2 of malfunction in detail

*1: Faulty system

| | | | | | | | | | | | | | | |
|---|-------------------|---|---|---|---|---|---|---|---------------------|---|--------|---------|---------|--------|
| <table border="1"> <tr><td>●</td><td>●</td></tr> <tr><td>●</td><td>◐</td></tr> <tr><td>◐</td><td>●</td></tr> <tr><td>◐</td><td>◐</td></tr> </table> | ● | ● | ● | ◐ | ◐ | ● | ◐ | ◐ | → Individual system | <table border="1"> <tr><td>Master</td></tr> <tr><td>Slave 1</td></tr> <tr><td>Slave 2</td></tr> <tr><td>System</td></tr> </table> | Master | Slave 1 | Slave 2 | System |
| ● | ● | | | | | | | | | | | | | |
| ● | ◐ | | | | | | | | | | | | | |
| ◐ | ● | | | | | | | | | | | | | |
| ◐ | ◐ | | | | | | | | | | | | | |
| Master | | | | | | | | | | | | | | |
| Slave 1 | | | | | | | | | | | | | | |
| Slave 2 | | | | | | | | | | | | | | |
| System | | | | | | | | | | | | | | |
| → | Right-hand system | | | | | | | | | | | | | |
| → | Left-hand system | | | | | | | | | | | | | |
| → | — | | | | | | | | | | | | | |
| → | All systems | | | | | | | | | | | | | |

<Monitor mode>

To enter the monitor mode, push the **MODE (BS1)** button when in "Setting mode 1".

* Refer to Page 78 for Monitor mode.

<Selection of setting item>

Push the **SET (BS2)** button and set the LED display to a setting item.

* Refer to Page 78 for Monitor mode.

<Confirmation of malfunction 1>

Push the **RETURN (BS3)** button once to display "First digit" of malfunction code.

<Confirmation of malfunction 2>

Push the **SET (BS2)** button once to display "Second digit" of malfunction code.

<Confirmation of malfunction 3>

Push the **SET (BS2)** button once to display "malfunction location".

<Confirmation of malfunction 4>

Push the **SET (BS2)** button once to display "master or slave 1 or slave 2" and "malfunction location".

Push the **RETURN (BS3)** button and switches to the initial status of "Monitor mode".

* Push the **MODE (BS1)** button and returns to "Setting mode 1".

Detail description on next page.

| Malfunctions | | Malfunction code |
|--|---|-------------------|
| Description of malfunction | Description of malfunction (PGF) | Remote controller |
| Open phase and unbalanced power supply | Unbalanced INV power supply voltage | P1 |
| INV radiation fin temperature sensor malfunction | INV fin thermistor malfunction | P4 |
| Faulty combination of INV and fan driver | Faulty combination of INV | PJ |
| Reversed phase | Reversed phase malfunction | U1 |
| | Reversed phase malfunction (ON) | |
| Abnormal power supply voltage | Insufficient INV voltage | U2 |
| | INV open phase (single phase) | |
| | Abnormal charge of capacitor of INV main circuit | |
| Test run not carried out yet | Test run not carried out yet | U3 |
| Faulty transmission between indoor and outdoor units | IN-OUT transmission malfunction | U4 |
| | System malfunction | |
| Faulty transmission between outdoor units | Malfunction caused when mounting the external control adaptor | U7 |
| | Alarm given when mounting the external control adaptor | |
| | Malfunction caused between the master and the slave 1 | |
| | Malfunction caused between the master and the slave 2 | |
| | Multi REYQ models connected | |
| | Faulty address setting of slaves 1 and 2 | |
| | 4 or more outdoor units connected in the same system | |
| Erroneous address of slaves 1 and 2 | | |
| Faulty transmission with other systems | Other system or other unit in the same system | U9 |
| Faulty field setting | Excess indoor units connected | UA |
| | Erroneous refrigerant used for indoor unit | |
| | Faulty combination of outdoor units | |
| | Faulty independent installation | |
| | Faulty connection of former BS unit | |
| | Faulty connection between outdoor and BS unit | |
| Faulty system line | Wrong wiring (auto address error) | UH |
| | Wrong number of indoor units connected to BS unit | |
| Faulty transmission with accessory equipment | Multi level converter malfunction | UJ |
| | Multi level converter alarm | |
| | Multi level converter data malfunction | |
| | Multi level converter transmission malfunction | |
| Unmatched wiring/piping, no system settings | Unmatched wiring/piping | UF |

○ : ON
 ● : Blink
 ● : OFF

○: ON ●: OFF ◐: Blink

| Malfunction code | Confirmation of malfunction 1 (Check 1) | | | | | | | Confirmation of malfunction 2 (Check 2) | | | | | | | Confirmation of malfunction 3 (Check 3) | | | | | | | Confirmation of malfunction 4 (Check 4) | | | | | | | |
|------------------|---|-----|-----|-----|-----|-----|-----|---|-----|-----|-----|-----|-----|-----|---|-----|-----|-----|-----|-----|-----|---|-----|-----|-----|-----|-----|-----|---|
| | H1P | H2P | H3P | H4P | H5P | H6P | H7P | H1P | H2P | H3P | H4P | H5P | H6P | H7P | H1P | H2P | H3P | H4P | H5P | H6P | H7P | H1P | H2P | H3P | H4P | H5P | H6P | H7P | |
| P1 | ○ | ○ | ● | ○ | ● | ● | ● | ○ | | | ● | ● | ● | ○ | ○ | | | ● | ● | ● | ● | ○ | | | ● | ● | *1 | | |
| P4 | | | | | | | | ○ | | | ● | ○ | ● | ● | ○ | | | ● | ● | ● | ● | ○ | | | ● | ● | | | |
| PJ | | | | | | | | ○ | | | ○ | ○ | ● | ○ | ○ | | | ● | ● | ● | ● | ○ | | | ● | ● | | | |
| U1 | ○ | ○ | ● | ○ | ● | ● | ○ | ○ | | | ● | ● | ● | ○ | ○ | | | ● | ● | ● | ● | ○ | | | ● | ● | *1 | | |
| U2 | | | | | | | | ○ | | | ● | ● | ○ | ● | ○ | | | ● | ● | ● | ● | ○ | | | ● | ○ | | | |
| U3 | | | | | | | | ○ | | | ● | ● | ○ | ○ | ○ | | | ● | ● | ● | ● | ○ | | | ● | ● | | ○ | ○ |
| U4 | | | | | | | | ○ | | | ● | ○ | ● | ● | ○ | | | ● | ● | ● | ● | ○ | | | ● | ● | | ○ | ○ |
| U7 | | | | | | | | ○ | | | ● | ○ | ○ | ○ | ○ | | | ● | ● | ● | ● | ○ | | | ● | ● | | ○ | ○ |
| | | | | | | | | ○ | | | ● | ○ | ○ | ○ | ○ | | | ● | ● | ● | ● | ○ | | | ● | ○ | | ○ | ○ |
| | | | | | | | | ○ | | | ● | ○ | ○ | ○ | ○ | | | ● | ● | ● | ● | ○ | | | ● | ○ | | ○ | ○ |
| | | | | | | | | ○ | | | ● | ○ | ○ | ○ | ○ | | | ● | ● | ● | ● | ○ | | | ● | ○ | | ○ | ○ |
| | | | | | | | | ○ | | | ● | ○ | ○ | ○ | ○ | | | ● | ● | ● | ● | ○ | | | ● | ○ | | ○ | ○ |
| | | | | | | | | ○ | | | ● | ○ | ○ | ○ | ○ | | | ● | ● | ● | ● | ○ | | | ● | ○ | | ○ | ○ |
| U9 | | | | | | | | ○ | | | ○ | ● | ● | ○ | ○ | | | ● | ● | ● | ● | ○ | | | ● | ● | ○ | ○ | |
| UA | | | | | | | | ○ | | | ○ | ● | ○ | ● | ○ | | | ● | ● | ● | ● | ○ | | | ○ | ● | ○ | ○ | |
| | | | | | | | | ○ | | | ○ | ● | ○ | ○ | ○ | | | ● | ● | ● | ○ | ○ | | | ○ | ○ | ○ | ○ | |
| | | | | | | | | ○ | | | ○ | ○ | ○ | ○ | ○ | | | ● | ○ | ○ | ○ | ○ | | | ○ | ○ | ○ | ○ | |
| | | | | | | | | ○ | | | ○ | ○ | ○ | ○ | ○ | | | ● | ○ | ○ | ○ | ○ | | | ○ | ○ | ○ | ○ | |
| | | | | | | | | ○ | | | ○ | ○ | ○ | ○ | ○ | | | ● | ○ | ○ | ○ | ○ | | | ○ | ○ | ○ | ○ | |
| | | | | | | | | ○ | | | ○ | ○ | ○ | ○ | ○ | | | ● | ○ | ○ | ○ | ○ | | | ○ | ○ | ○ | ○ | |
| UH | | | | | | | | ○ | | | ○ | ● | ○ | ○ | ○ | | | ● | ● | ● | ○ | ○ | | | ○ | ○ | ○ | ○ | |
| UJ | | | | | | | | ○ | | | ○ | ○ | ● | ○ | ○ | | | ● | ● | ● | ○ | ○ | | | ○ | ○ | *1 | | |
| | | | | | | | | ○ | | | ○ | ○ | ○ | ○ | ○ | | | ● | ○ | ○ | ○ | ○ | | | ○ | ○ | | | |
| | | | | | | | | ○ | | | ○ | ○ | ○ | ○ | ○ | | | ● | ○ | ○ | ○ | ○ | | | ○ | ○ | | | |
| UF | | ○ | ● | | | | | ○ | | | ○ | ○ | ○ | ○ | ○ | | | ● | ● | ● | ○ | ○ | | | ○ | ○ | ○ | ○ | |

Display of contents of malfunction (first digit)

Display of contents of malfunction (second digit)

Display 1 of malfunction in detail

Display 2 of malfunction in detail

*1: Faulty system

| | | | | | | | | | | | | | |
|--|---------------------|---------------------|-----|--------------------|-----|-----|-----|---------------|---|--------|---------|---------|--------|
| Individual system | Multi system | | | | | | | | | | | | |
| <table border="0"> <tr> <td>● ●</td> <td>→ Right-hand system</td> </tr> <tr> <td>● ○</td> <td>→ Left-hand system</td> </tr> <tr> <td>○ ●</td> <td>→ —</td> </tr> <tr> <td>○ ○</td> <td>→ All systems</td> </tr> </table> | ● ● | → Right-hand system | ● ○ | → Left-hand system | ○ ● | → — | ○ ○ | → All systems | <table border="0"> <tr> <td>Master</td> </tr> <tr> <td>Slave 1</td> </tr> <tr> <td>Slave 2</td> </tr> <tr> <td>System</td> </tr> </table> | Master | Slave 1 | Slave 2 | System |
| ● ● | → Right-hand system | | | | | | | | | | | | |
| ● ○ | → Left-hand system | | | | | | | | | | | | |
| ○ ● | → — | | | | | | | | | | | | |
| ○ ○ | → All systems | | | | | | | | | | | | |
| Master | | | | | | | | | | | | | |
| Slave 1 | | | | | | | | | | | | | |
| Slave 2 | | | | | | | | | | | | | |
| System | | | | | | | | | | | | | |

2.6 “E1” Outdoor Unit: PCB Defect

| | |
|--|---|
| Remote Controller Display | E1 |
| Applicable Models | RQYQ-PY1 RREQ-PY1 |
| Method of Malfunction Detection | Abnormality is detected under the communication conditions in the hardware section between the indoor unit and outdoor unit. |
| Malfunction Decision Conditions | When the communication conditions in the hardware section between the indoor unit and the outdoor unit are not normal. |
| Supposed Causes | <ul style="list-style-type: none"> ■ Defect of outdoor unit PCB (A1P) ■ Defective connection of inside/ outside relay wires |

Troubleshooting

 **Caution** Be sure to turn off power switch before connect or disconnect connector, or parts damage may be occurred.

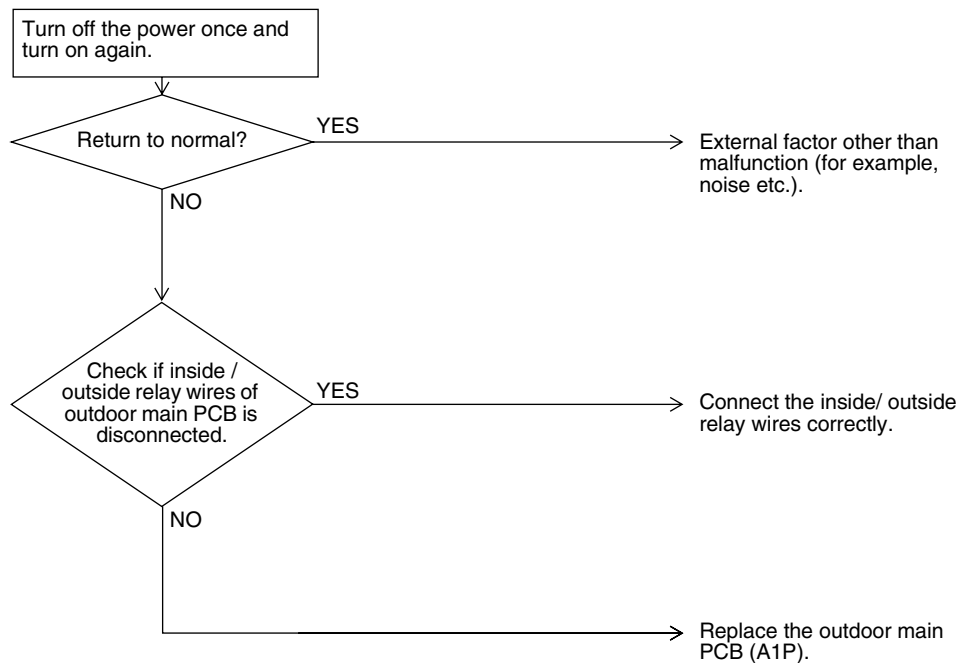

2.7 “E2” Outdoor Unit: Actuation of High Pressure Switch

| | |
|--|--|
| Remote Controller Display | E2 |
| Applicable Models | RQYQ-PY1 RREQ-PY1 |
| Method of Malfunction Detection | Malfunction is detected by the relationship between "pressure detected by the high pressure sensor" and "operation of the high pressure switch". |
| Malfunction Decision Conditions | When the high pressure switch operates under low pressure detected by the high pressure sensor during compressor operation. Operating pressure of high pressure switch: 0.07MPa |
| Supposed Causes | <ul style="list-style-type: none"> ■ Defect of high pressure sensor ■ Defect of connection of connector for high pressure switch ■ Defect of high pressure switch |

Troubleshooting

 **Caution** Be sure to turn off power switch before connect or disconnect connector, or parts damage may be occurred.

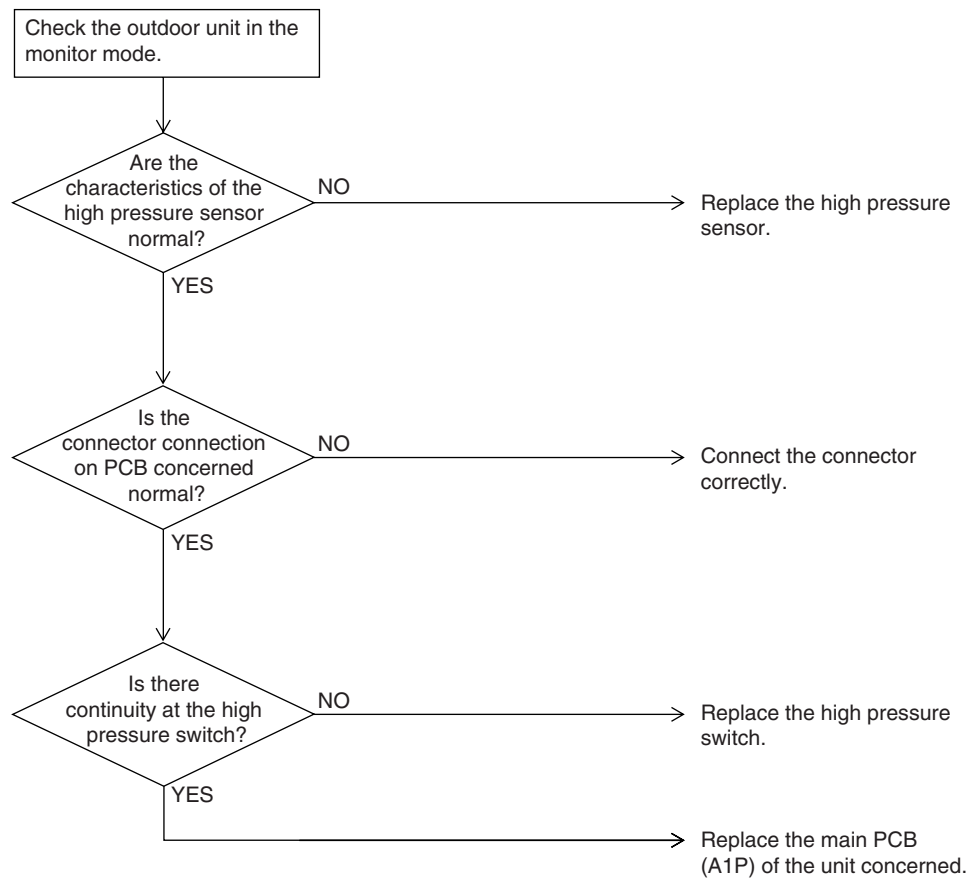

2.8 “E3” Outdoor Unit: Actuation of High Pressure Switch

| | |
|--|---|
| Remote Controller Display | E3 |
| Applicable Models | RQYQ-PY1 RQEQ-PY1 |
| Method of Malfunction Detection | Use the protection device circuit to detect continuity at the high pressure switch. |
| Malfunction Decision Conditions | Abnormality is detected when the contact of the high pressure protection switch opens. (Reference) Operating pressure of high pressure switch Operating pressure: 4.0MPa Reset pressure: 3.0MPa |
| Supposed Causes | <ul style="list-style-type: none"> ■ Actuation of outdoor unit high pressure switch ■ Defect of high pressure switch ■ Defect of outdoor unit main PCB (A1P) ■ Instantaneous power failure ■ Faulty high pressure sensor |

Troubleshooting

Caution Be sure to turn off power switch before connect or disconnect connector, or parts damage may be occurred.

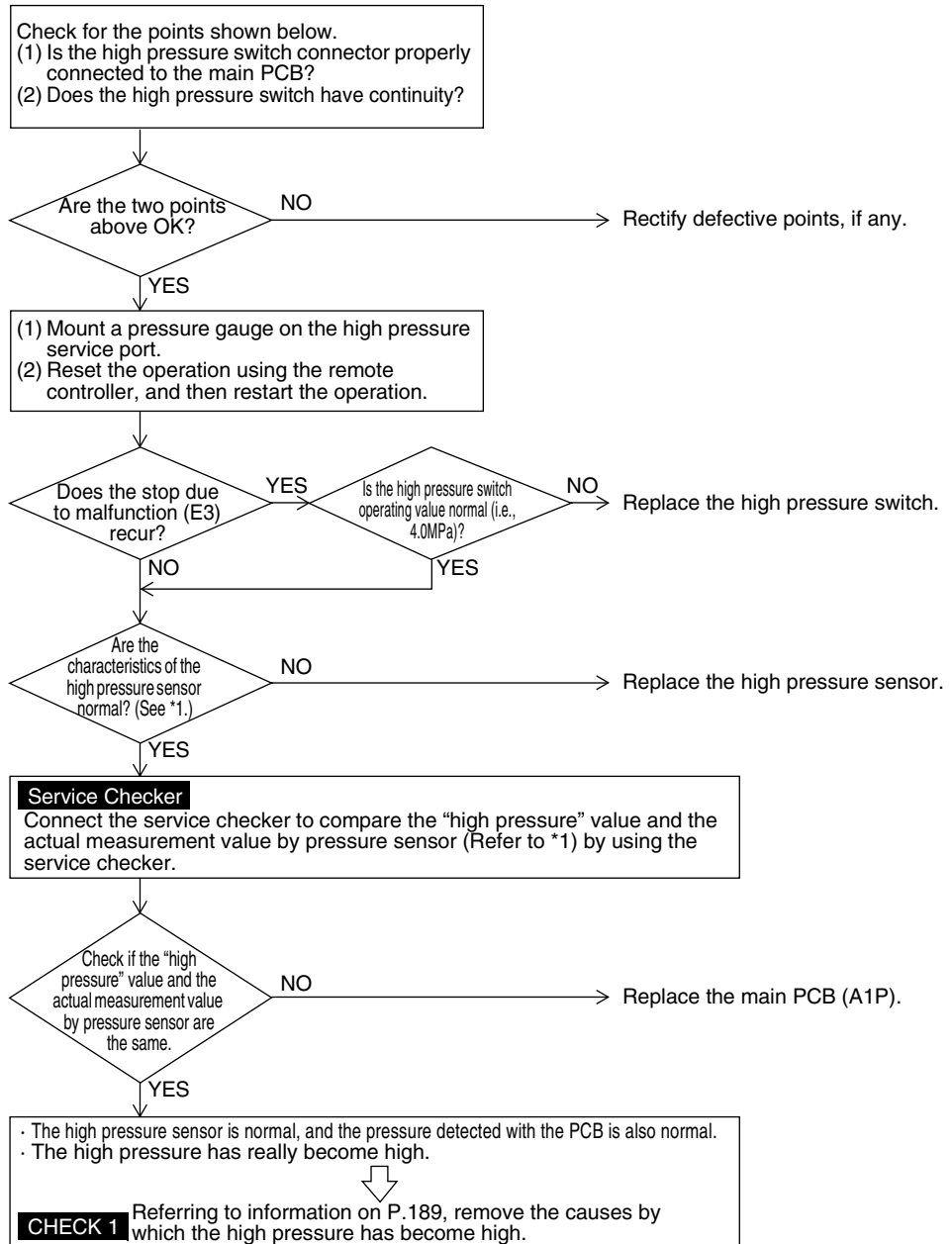

*1: Make a comparison between the voltage of the pressure sensor and that read by the pressure gauge.
(As to the voltage of the pressure sensor, make measurement of voltage at the connector, and then convert it to pressure according to information on P.201.)
*2: Make measurement of voltage of the pressure sensor.

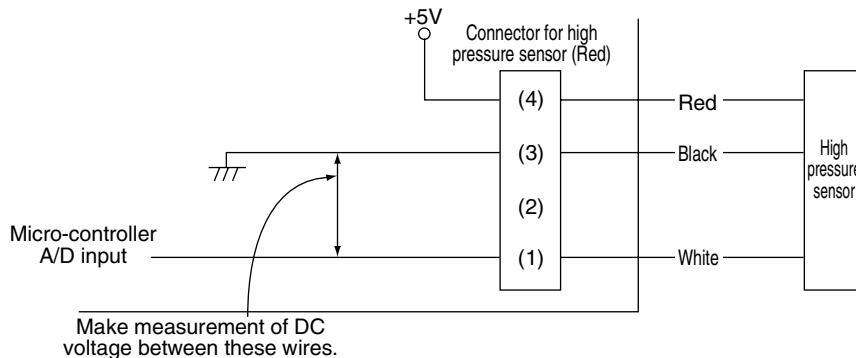

2.9 “E4” Outdoor Unit: Actuation of Low Pressure Sensor

| | |
|--|--|
| Remote Controller Display | E4 |
| Applicable Models | RQYQ-PY1 RQEQ-PY1 |
| Method of Malfunction Detection | Abnormality is detected by the pressure value of the low pressure sensor with the main PCB. |
| Malfunction Decision Conditions | Error is generated when the low pressure is dropped under compressor operation. Operating pressure:0.07MPa |
| Supposed Causes | <ul style="list-style-type: none"> ■ Abnormal drop of low pressure ■ Defect of low pressure sensor ■ Defect of outdoor unit PCB (A1P) ■ Stop valve is left in closed |

Troubleshooting



Caution

Be sure to turn off power switch before connect or disconnect connector, or parts damage may be occurred.

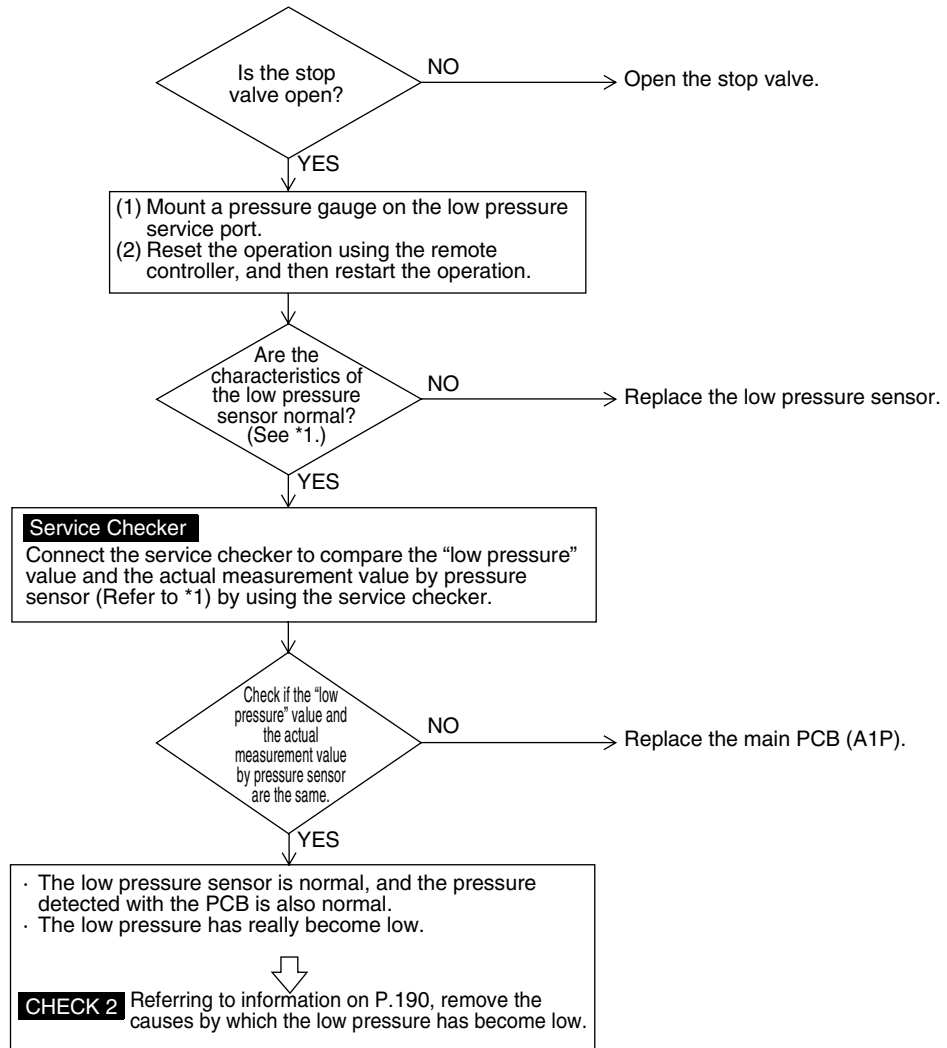

*1: Make a comparison between the voltage of the pressure sensor and that read by the pressure gauge.
 (As to the voltage of the pressure sensor, make measurement of voltage at the connector, and then convert it to pressure according to information on P.201.)

*2: Make measurement of voltage of the pressure sensor.

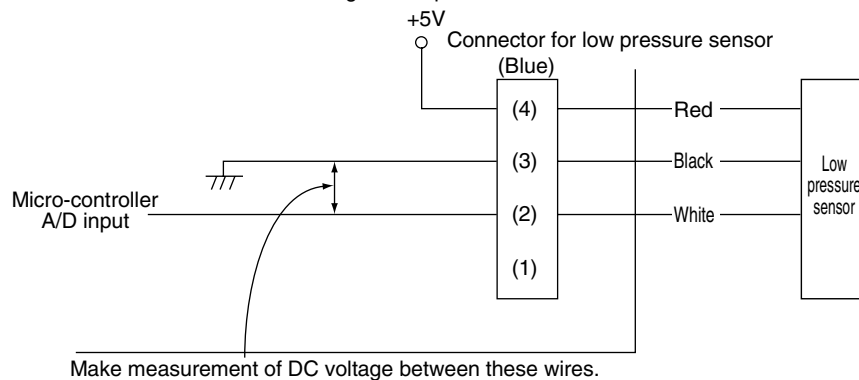

2.10 “E5” Outdoor Unit: Inverter Compressor Motor Lock

| | |
|--|--|
| Remote Controller Display | E5 |
| Applicable Models | RQYQ-PY1 RREQ-PY1 |
| Method of Malfunction Detection | Inverter PCB takes the position signal from UVW line connected between the inverter and compressor, and the malfunction is detected when any abnormality is observed in the phase-current waveform. |
| Malfunction Decision Conditions | This malfunction will be output when the inverter compressor motor does not start up even in forced startup mode. |
| Supposed Causes | <ul style="list-style-type: none"> ■ Inverter compressor lock ■ High differential pressure (0.5MPa or more) ■ Incorrect UVW wiring ■ Faulty inverter PCB ■ Stop valve is left in closed |

Troubleshooting



Caution

Be sure to turn off power switch before connect or disconnect connector, or parts damage may be occurred.

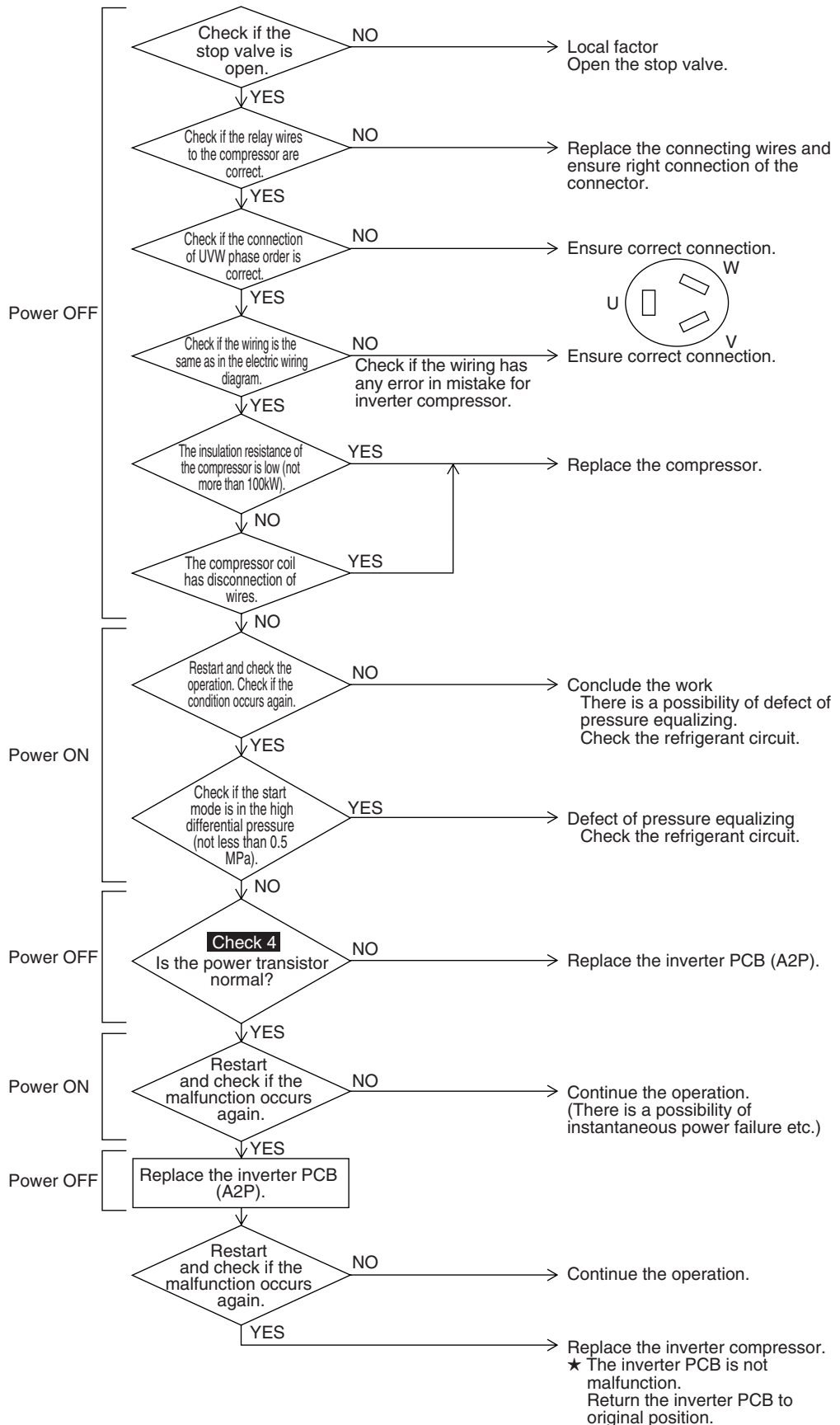

2.11 “E7” Outdoor Unit: Malfunction of Outdoor Unit Fan Motor

| | |
|--|---|
| Remote Controller Display | E7 |
| Applicable Models | RQYQ-PY1 RQE-Q-PY1 |
| Method of Malfunction Detection | <ol style="list-style-type: none"> ① Detect a malfunction based on the current value in the INVERTER PCB (as for motor 2, current value in the fan PCB). ② Detect a malfunction for the fan motor circuit based on the number of rotation detected by hole IC during the fan motor operation. |
| Malfunction Decision Conditions | <ul style="list-style-type: none"> ■ Overcurrent is detected for INVERTER PCB (A2P) or fan INVERTER PCB (A5P) (System down is caused by 4 times of detection.) ■ In the condition of fan motor rotation, the number of rotation is below the fixed number for more than 6 seconds. (System down is caused by 4 times of detection.) |
| Supposed Causes | <ul style="list-style-type: none"> ■ Failure of fan motor ■ Defect or connection error of the connectors/ harness between the fan motor and PCB ■ The fan can not rotate due to any foreign substances entangled. ■ Clear condition: Continue normal operation for 5 minutes |

Troubleshooting

Caution Be sure to turn off power switch before connect or disconnect connector, or parts damage may be occurred.

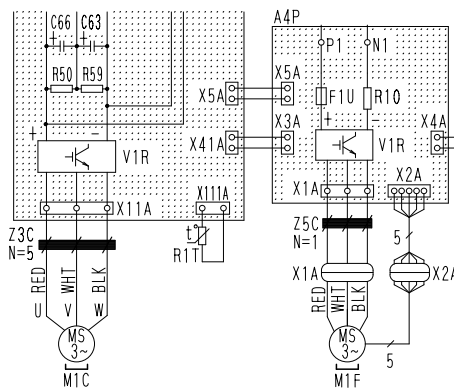
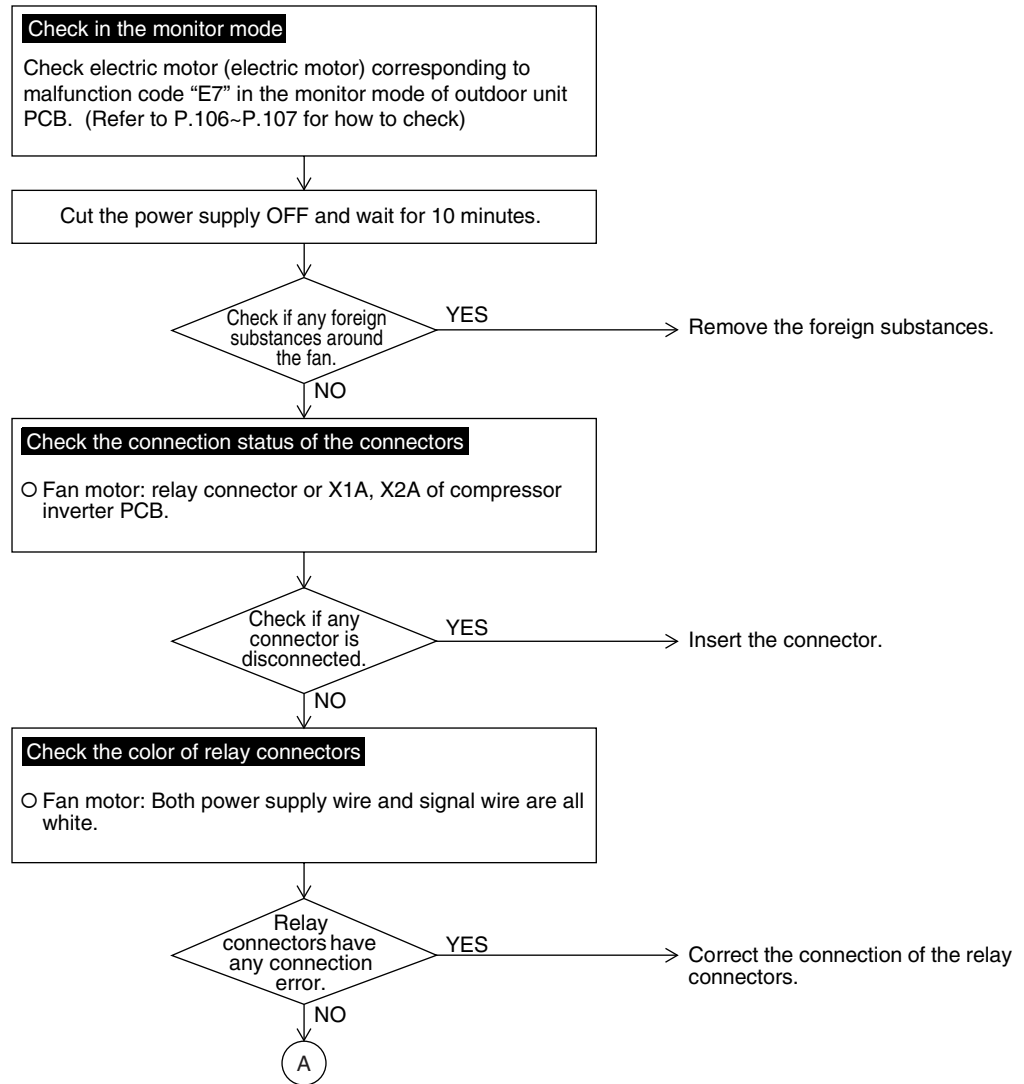

Troubleshooting

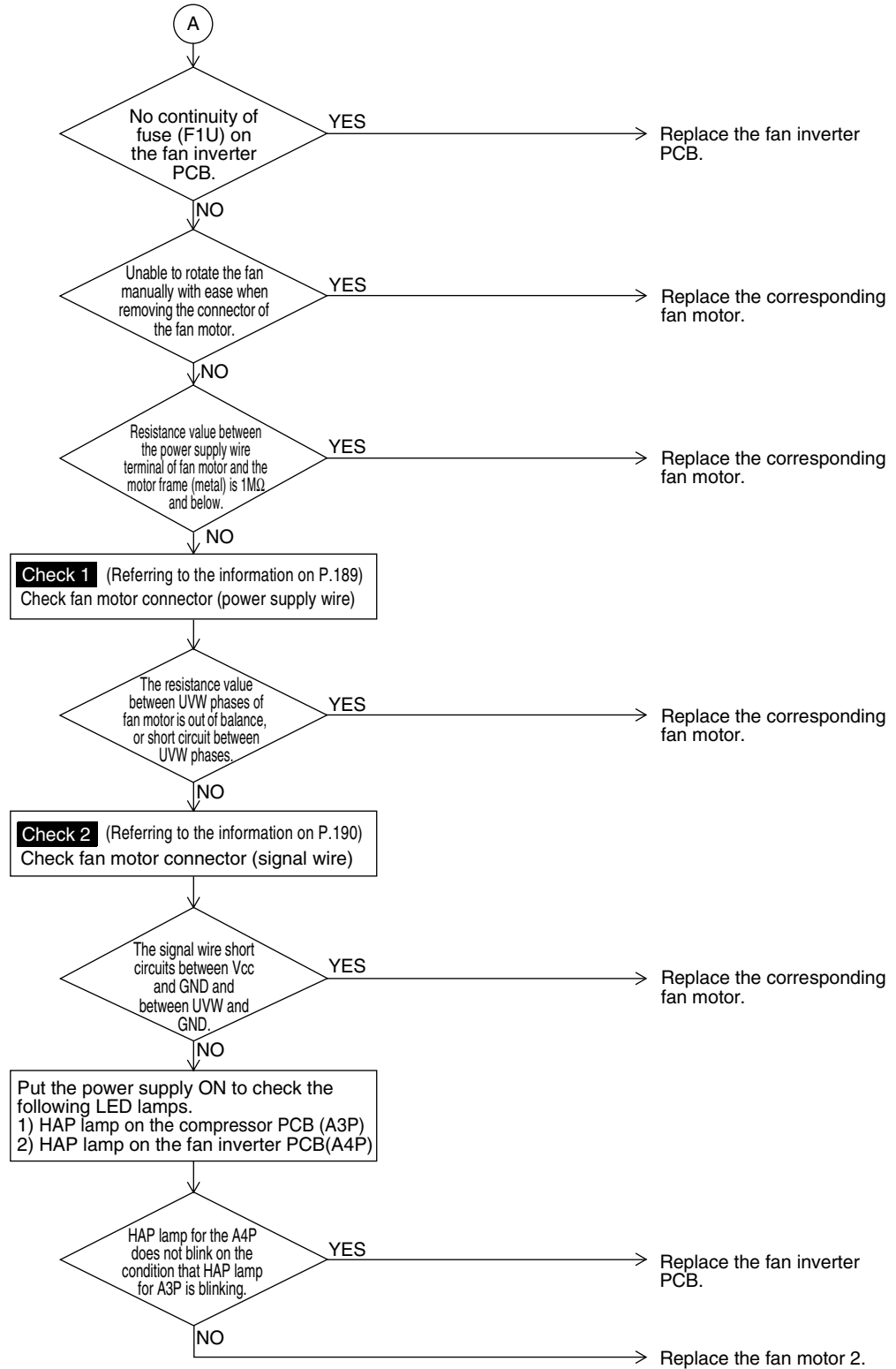

2.12 “E9” Outdoor Unit: Malfunction of Electronic Expansion Valve Coil (Y1E~Y3E)

| | |
|--|--|
| Remote Controller Display | E9 |
| Applicable Models | RQYQ-PY1 RREQ-PY1 |
| Method of Malfunction Detection | Check the continuity of electronic expansion valve coil (Y1E) |
| Malfunction Decision Conditions | No current is detected in the common (COM [+]) when power supply is ON. |
| Supposed Causes | <ul style="list-style-type: none"> ■ Disconnection of connectors for electronic expansion valve (Y1E) ■ Defect of electronic expansion valve coil ■ Defect of outdoor unit main PCB (A1P) |

Troubleshooting

Caution Be sure to turn off power switch before connect or disconnect connector, or parts damage may be occurred.

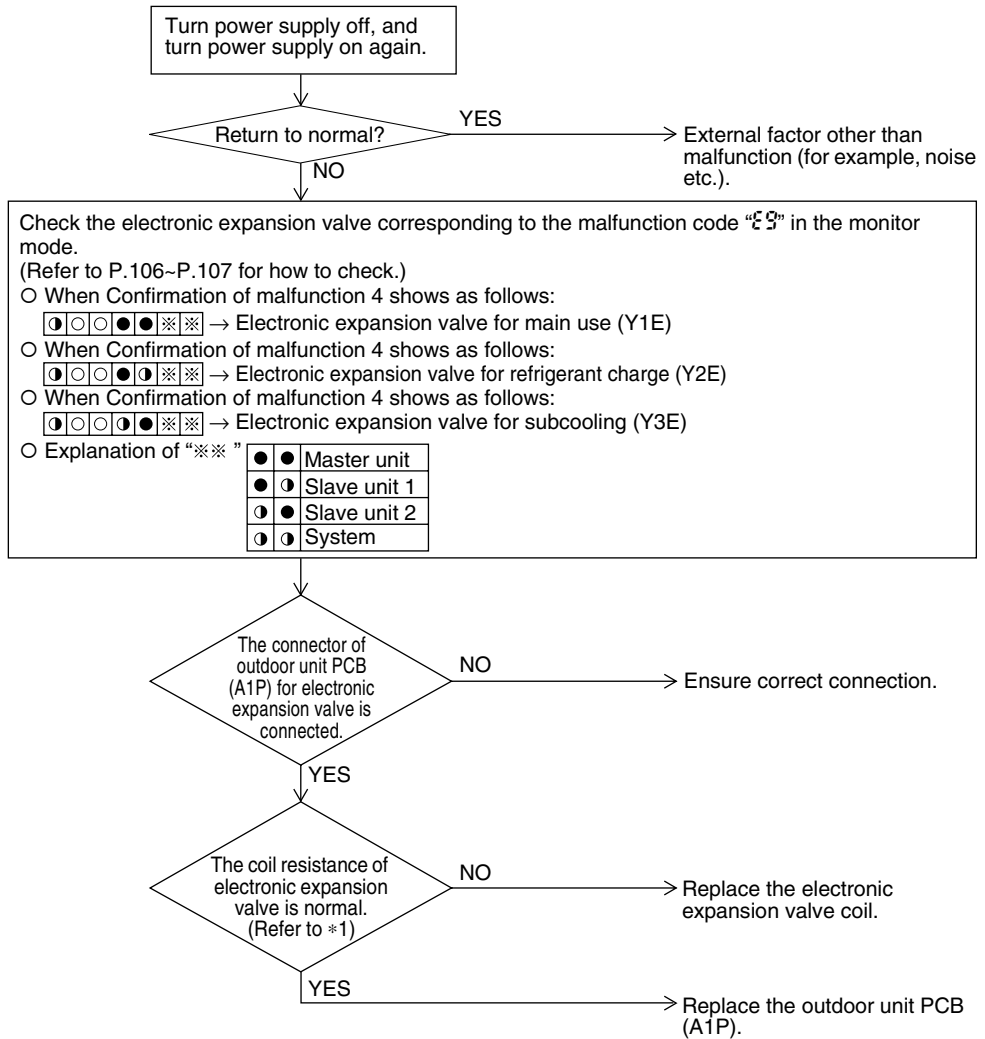

2.13 “F3” Outdoor Unit: Abnormal Discharge Pipe Temperature

| | |
|--|---|
| Remote Controller Display | F3 |
| Applicable Models | RQYQ-PY1 RREQ-PY1 |
| Method of Malfunction Detection | Abnormality is detected according to the temperature detected by the discharge pipe temperature sensor. |
| Malfunction Decision Conditions | When the discharge pipe temperature rises to an abnormally high level (135 °C and above) When the discharge pipe temperature rises suddenly (120 °C and above for 10 successive minutes) |
| Supposed Causes | <ul style="list-style-type: none"> ■ Faulty discharge pipe temperature ■ Faulty connection of discharge pipe thermistor ■ Faulty outdoor unit PCB (A1P) |

Troubleshooting

**Caution**

Be sure to turn off power switch before connect or disconnect connector, or parts damage may be occurred.

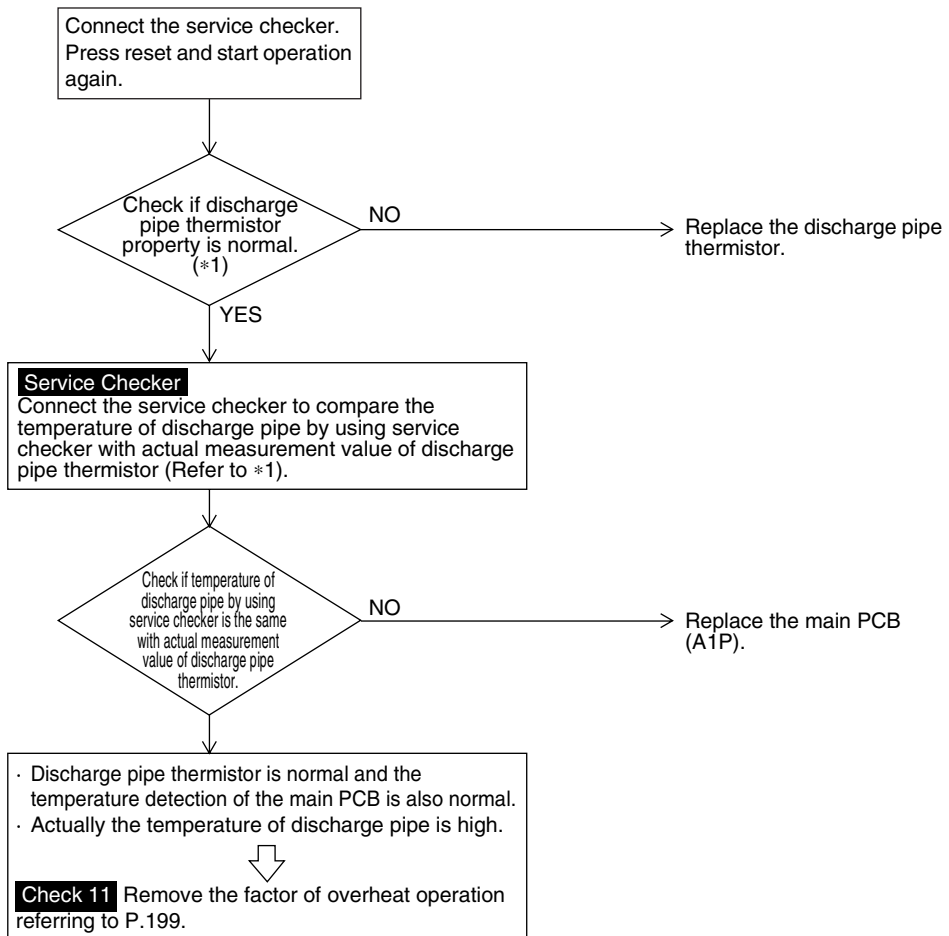

*1: Compare the resistance value of discharge pipe thermistor and the value based on the surface thermometer.



* Refer to "Thermistor Resistance / Temperature Characteristics" table on P199.

2.14 “F4” Outdoor Unit: Humidity alarm

| | |
|--|---|
| Remote Controller Display |  |
| Applicable Models | RQYQ-PY1 RREQ-PY1 |
| Method of Malfunction Detection | The condition of the liquid refrigerant returning to the compressor is detected by the temperature and pressure of any part during the cooling operation. |
| Malfunction Decision Conditions | When the following humidity condition continues for 30 minutes & { <ul style="list-style-type: none"> • Humidity condition in the indoor unit • Humidity condition in some indoor units |
| Supposed Causes | <ul style="list-style-type: none"> ■ Faulty suction pipe thermistor ■ Faulty discharge pipe thermistor ■ Defect of high pressure sensor ■ Defect of indoor unit electronic expansion valve ■ Contamination of the air filter |

Troubleshooting



Caution

Be sure to turn off power switch before connect or disconnect connector, or parts damage may be occurred.

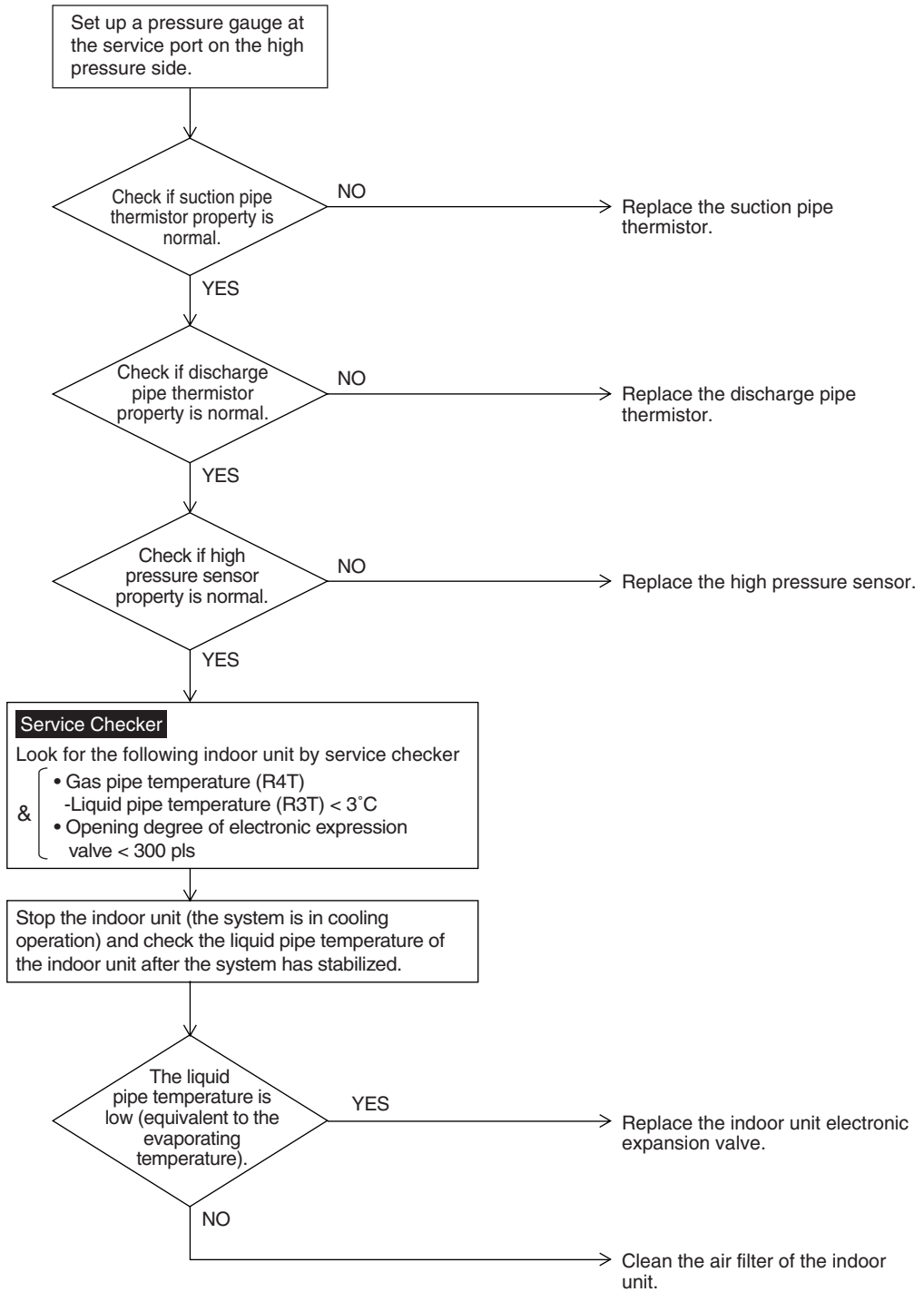

2.15 “F9” Outdoor Unit : Malfunction of BS Unit Electronic Expansion Valve

| | |
|--|--|
| Remote Controller Display | F9 |
| Applicable Models | BSVQ100-250PV1 RQCE-PY1 |
| Method of Malfunction Detection | This malfunction is detected by whether or not all coils of the electronic expansion valve have continuity. |
| Malfunction Decision Conditions | When the power supply turns ON, there is no currents pass through the common (COM[+]). |
| Supposed Causes | <ul style="list-style-type: none"> ■ Connector disconnected from the electronic expansion valve ■ Faulty of the electronic expansion valve coil ■ Faulty PCB of the BS unit |

Troubleshooting

Caution Be sure to turn off power switch before connect or disconnect connector, or parts damage may be occurred.

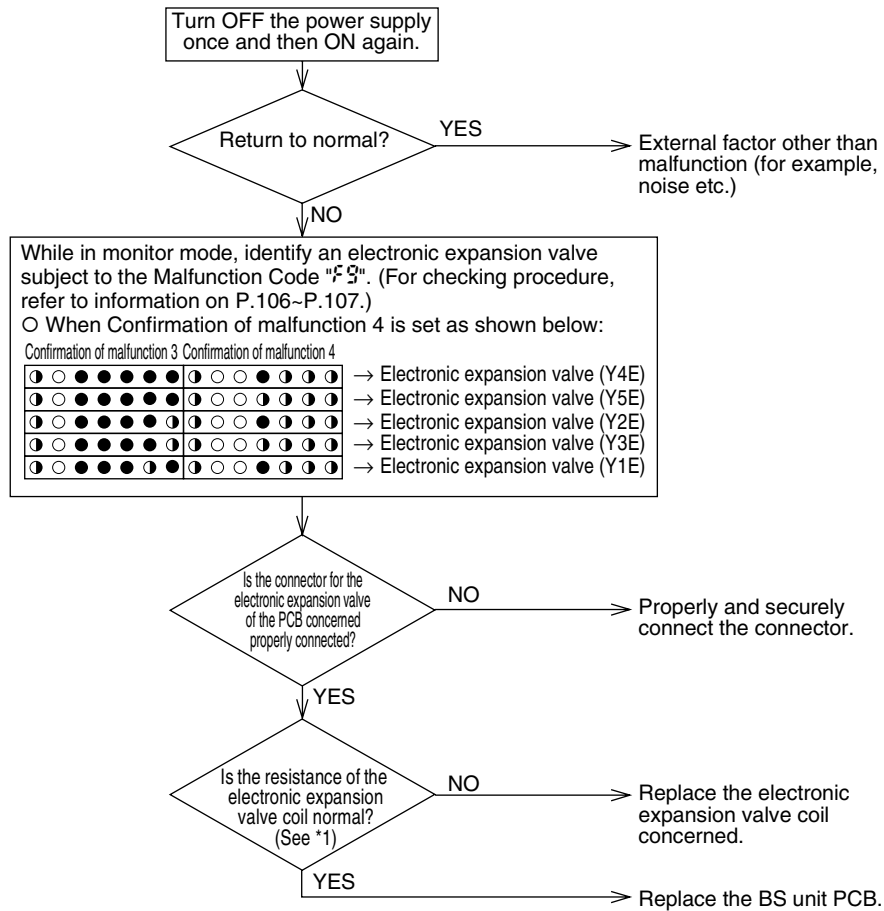

*1: Procedure for checking the electronic expansion valve for the drive unit coil.
 Disconnect the electronic expansion valve connector (X7A) from the PCB, and then make measurement of resistance and check for continuity between the connector pins to make judgement.

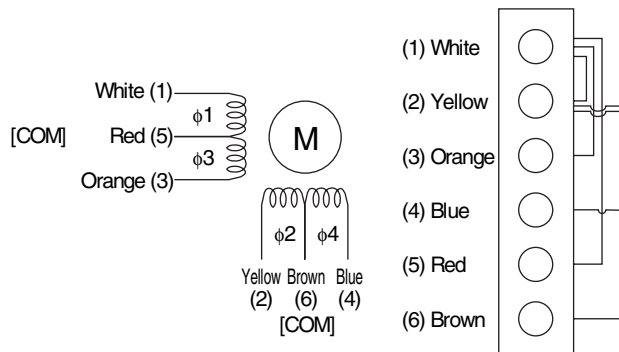

- The normal states are as follows:
- (1) No continuity between Pins (1) and (2)
 - (2) Approx. 300Ω resistance between Pins (1) and (3)
 - (3) Approx. 150Ω resistance between Pins (1) and (5)
 - (4) Approx. 300Ω resistance between Pins (2) and (4)
 - (5) Approx. 150Ω resistance between Pins (2) and (6)

2.16 “H7” Outdoor Unit: Abnormal Outdoor Fan Motor Signal

| | |
|--|---|
| Remote Controller Display | H7 |
| Applicable Models | RQYQ-PY1 RREQ-PY1 |
| Method of Malfunction Detection | Detection of abnormal signal from fan motor. |
| Malfunction Decision Conditions | In case of detection of abnormal signal at starting fan motor. |
| Supposed Causes | <ul style="list-style-type: none"> ■ Abnormal fan motor signal (circuit malfunction) ■ Broken, short or disconnection connector of fan motor connection cable ■ Fan Inverter PCB malfunction (A2P) |

Troubleshooting

 **Caution** Be sure to turn off power switch before connect or disconnect connector, or parts damage may be occurred.

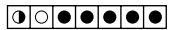
Check the fan motor corresponding to the malfunction code "H" in the monitor mode.
 (Refer to P.106~P.107 for how to check.)
 When Confirmation of malfunction 3 shows as follows:
 → Fan motor 1 (M1F)
 Explanation for "※※"

| | |
|----|--------------|
| ●● | Master unit |
| ●○ | Slave unit 1 |
| ○● | Slave unit 2 |
| ○○ | System |

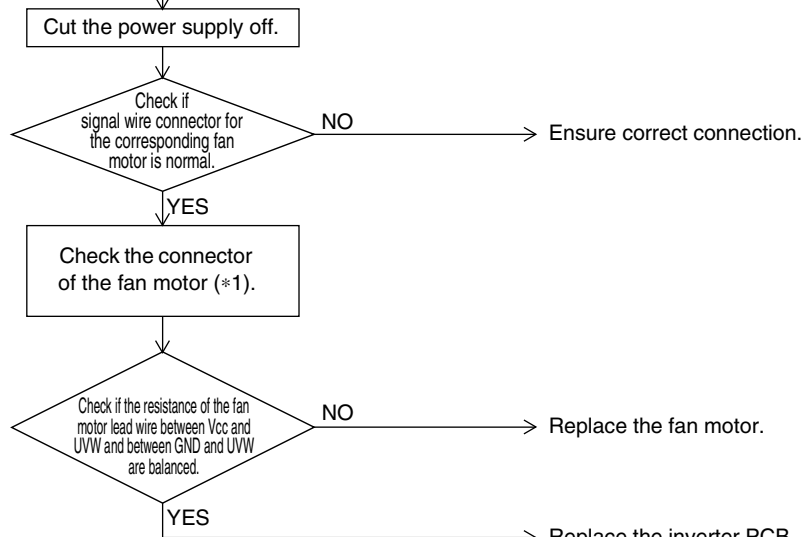

*1. Check the procedure for fan motor connector
 (1) Power OFF the fan motor.
 (2) Remove the connector (X2A or X4A) on the PCB to measure the following resistance value.
 Judgement criteria: resistance value between each phase is within ±20%
 ●For fan motor 1: replace the inverter PCB (A4P)

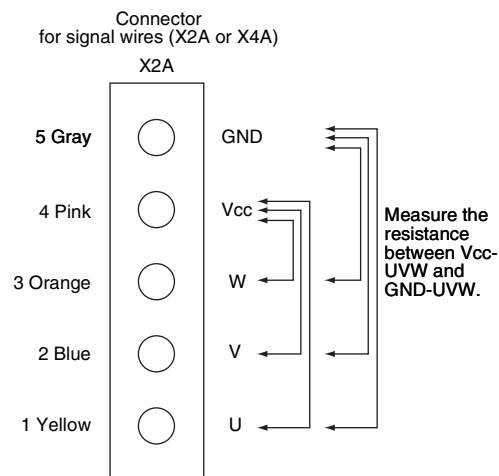

2.17 “H9” Outdoor Unit: Malfunction of Thermistor (R1T) for Outdoor Air

Remote Controller Display

H9

Applicable Models

RQYQ-PY1
RQEQ-PY1

Method of Malfunction Detection

Malfunction is detected from the temperature detected by the outdoor air thermistor.

Malfunction Decision Conditions

When the outdoor air temperature thermistor has short circuit or open circuit.

Supposed Causes

- Defective outdoor air thermistor connection
- Defect of outdoor air thermistor (R1T) for outdoor air
- Defect of outdoor unit PCB (A1P)

Troubleshooting



Caution

Be sure to turn off power switch before connect or disconnect connector, or parts damage may be occurred.

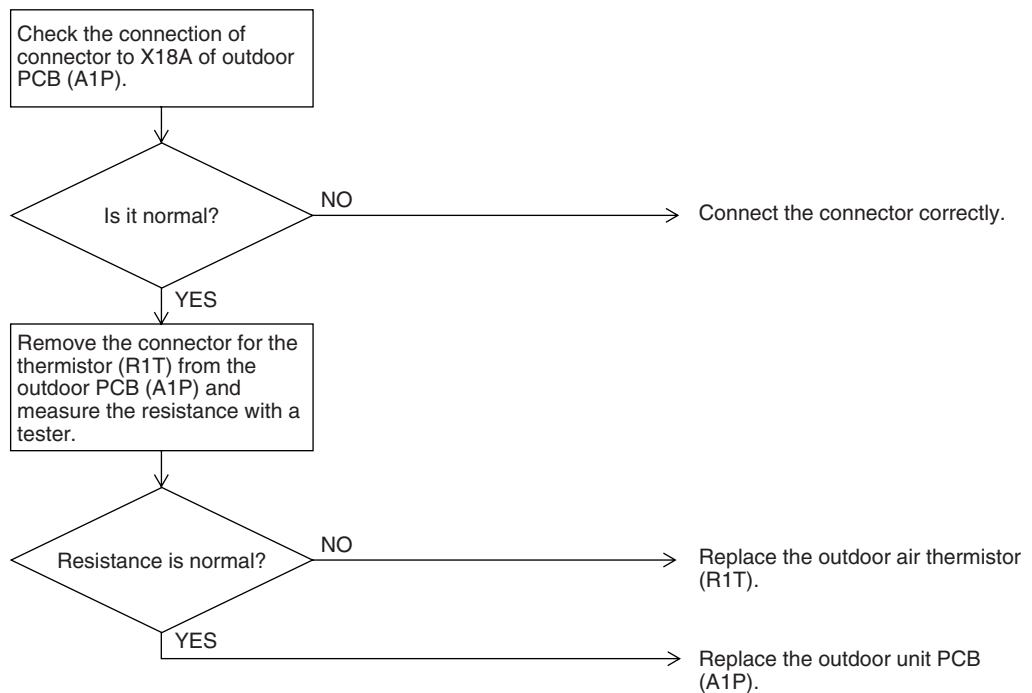

* Refer to “Thermistor Resistance / Temperature Characteristics” table on P199.

2.18 “U3, U4, U5, U6, U7, U8, U9” Outdoor Unit: Malfunction of Outdoor unit Thermistor

| | |
|--|--|
| Remote Controller Display | U3, U4, U5, U6, U7, U8, U9 |
| Applicable Models | RQYQ-PY1 RQEQ-PY1 |
| Method of Malfunction Detection | Malfunction is detected from the temperature by each thermistor. |
| Malfunction Decision Conditions | When a thermistor disconnection or short circuit occurs during operation. |
| Supposed Causes | <ul style="list-style-type: none"> ■ Defect of connection of thermistor ■ Defect of thermistor ■ Defect of outdoor unit PCB |

Troubleshooting



Caution Be sure to turn off power switch before connect or disconnect connector, or parts damage may be occurred.

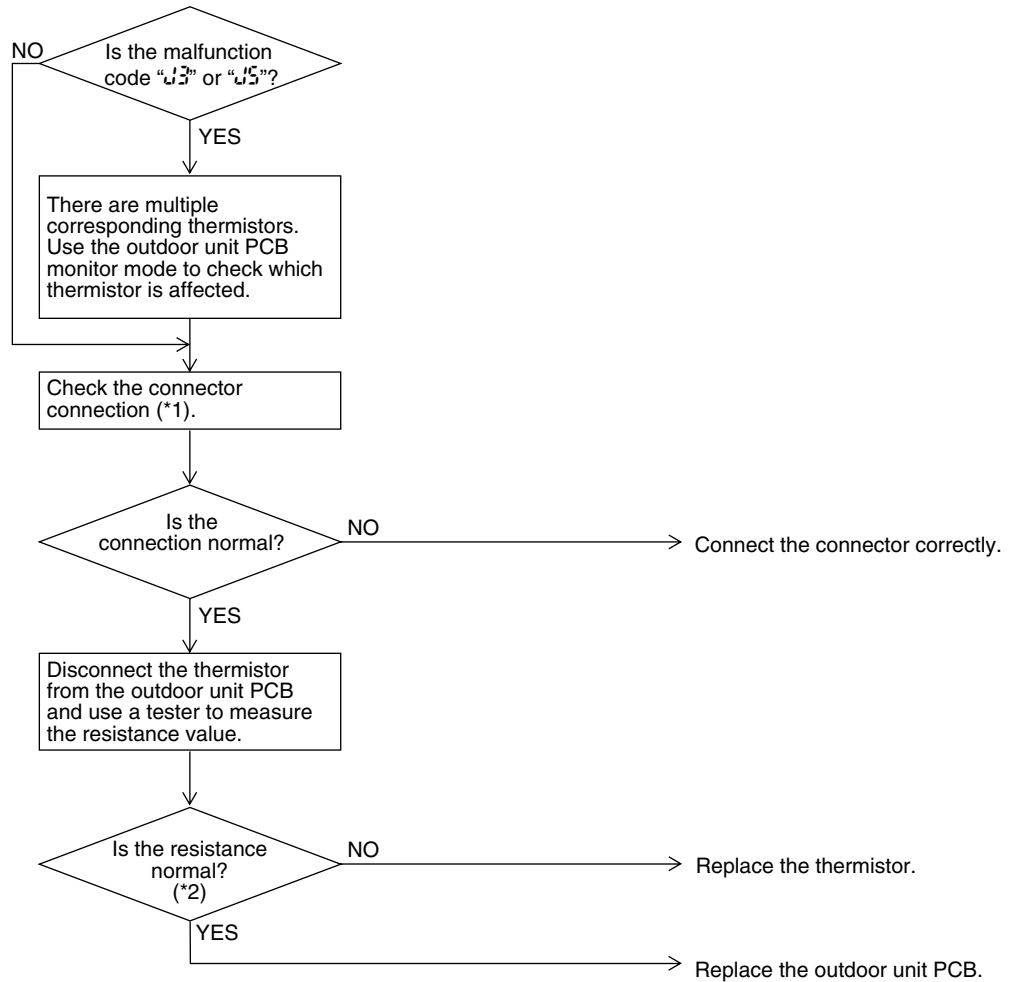

*1. Malfunction code, details of trouble, and electric symbol

| Malfunction code | Corresponding thermistor | Electric symbol | Connector |
|------------------|--|-----------------|---------------------------------|
| J3 | Discharge pipe thermistor (M1C) | R2T | X29A (Collective thermistor) |
| | Heat exchanger liquid pipe thermistor | | |
| J8 | Heat exchanger liquid pipe thermistor | R3T | |
| J4 | Heat exchanger gas pipe thermistor | R4T | |
| J5 | Suction pipe thermistor | R5T | X30A (Collective thermistor) |
| J6 | Heat exchanger thermistor | R6T | |
| J7 | Subcooling heat exchanger liquid pipe thermistor | R8T | |
| | Liquid pipe thermistor | R9T | |
| J9 | Subcooling heat exchanger gas pipe thermistor | R7T | |



*2 Refer to "Thermistor Resistance / Temperature Characteristics" table on P.199.

2.19 “” Outdoor Unit: Malfunction of High Pressure Sensor

| | |
|--|--|
| Remote Controller Display |  |
| Applicable Models | RQYQ-PY1 RREQ-PY1 |
| Method of Malfunction Detection | Malfunction is detected from the pressure detected by the high pressure sensor. |
| Malfunction Decision Conditions | When the high pressure sensor is short circuit or open circuit. (Not less than 4.22MPa, or 0.01MPa and below) |
| Supposed Causes | <ul style="list-style-type: none"> ■ Defect of high pressure sensor ■ Connection of low pressure sensor with wrong connection. ■ Defect of outdoor unit PCB ■ Defective connection of high pressure sensor |

Troubleshooting

 **Caution** Be sure to turn off power switch before connect or disconnect connector, or parts damage may be occurred.

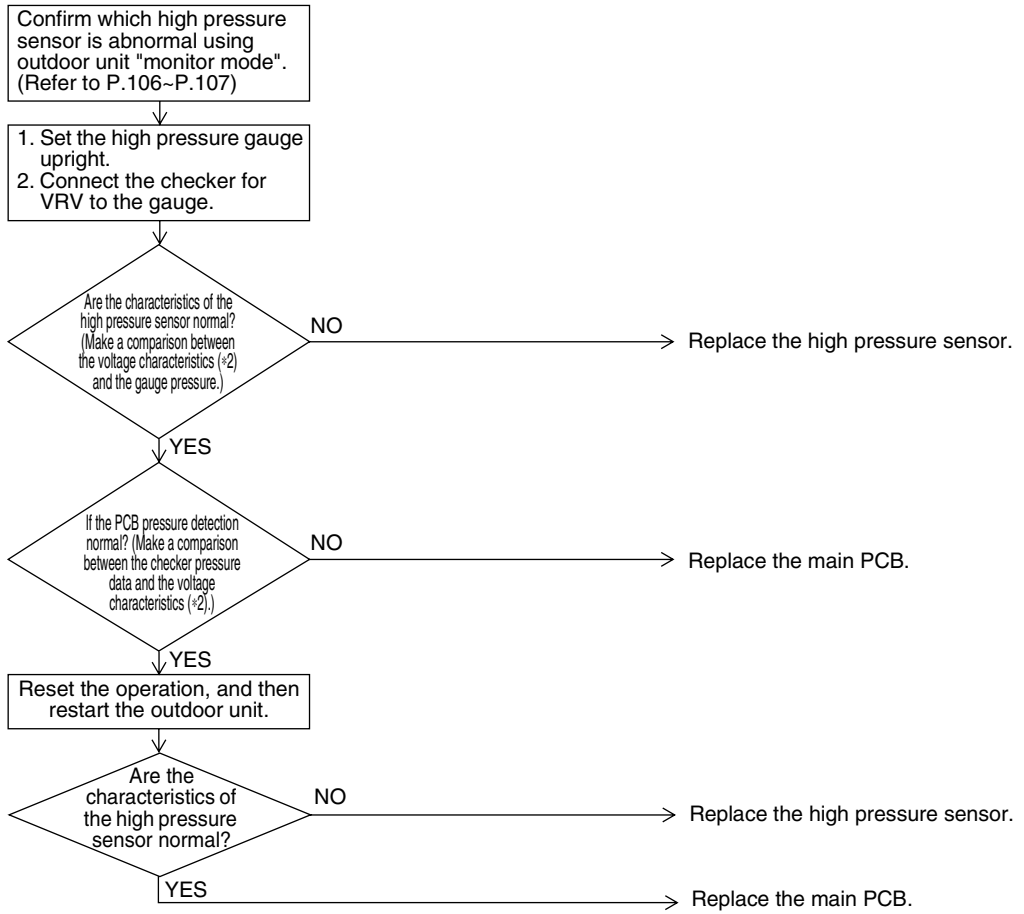

*1: Pressure sensor subject to malfunction code

| Malfunction code | Pressure sensor subject to malfunction code | Electric symbol |
|------------------|---|-----------------|
| JA | High pressure sensor | S1NPH |

*2: Voltage measurement point

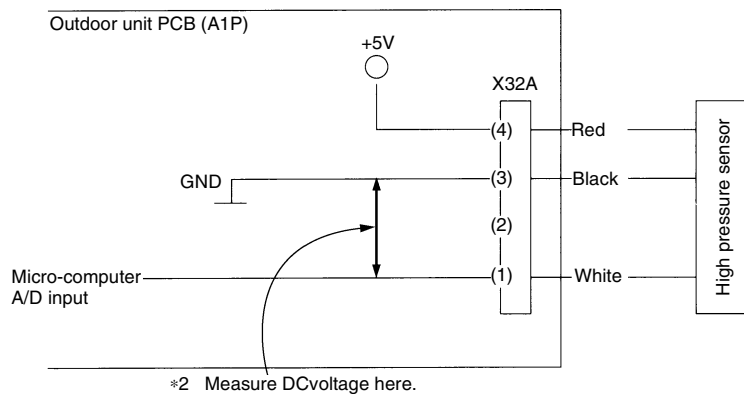

*2: Refer to "Pressure Sensor, Pressure / Voltage Characteristics" table on P201.

2.20 “” Outdoor Unit: Malfunction of Low Pressure Sensor

Remote
Controller
Display



Applicable
Models

RQYQ-PY1
RQEQ-PY1

Method of
Malfunction
Detection

Malfunction is detected from the pressure detected by the low pressure sensor.

Malfunction
Decision
Conditions

When the low pressure sensor is short circuit or open circuit.
(Not less than 1.77MPa, or -0.01MPa and below)

Supposed
Causes

- Defect of low pressure sensor
- Connection of high pressure sensor with wrong connection.
- Defect of outdoor unit PCB
- Defective connection of low pressure sensor

Troubleshooting



Caution

Be sure to turn off power switch before connect or disconnect connector, or parts damage may be occurred.

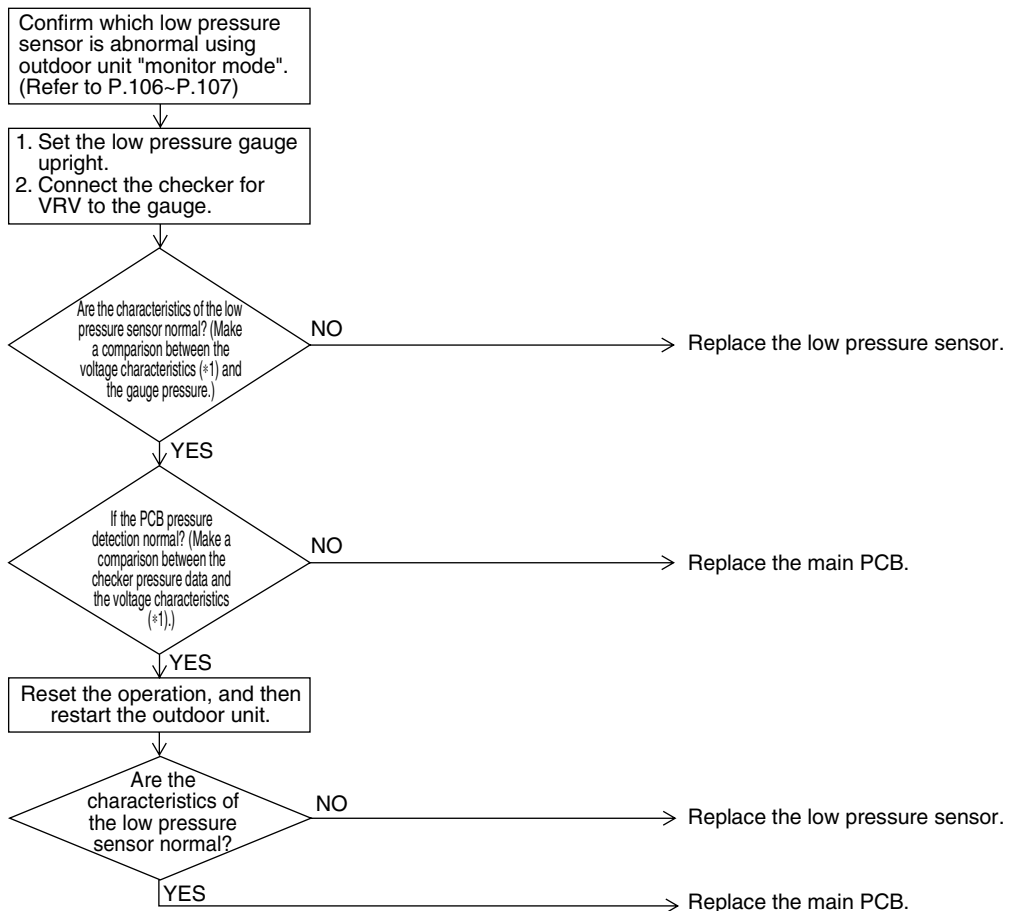

*1: Voltage measurement point

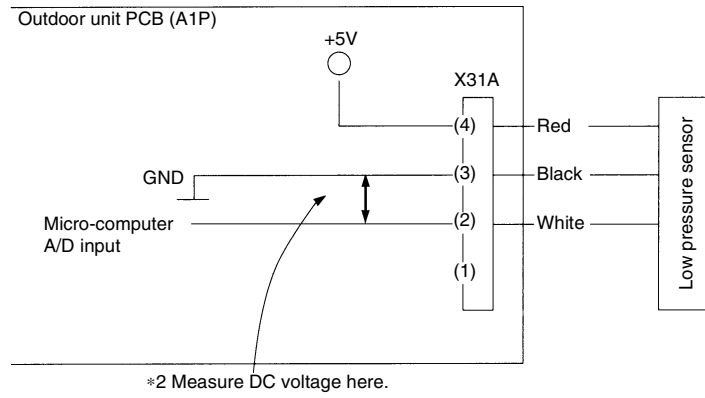

*2: Refer to "Pressure Sensor, Pressure / Voltage Characteristics" table on P201.

2.21 “L I” Outdoor Unit: Malfunction of Inverter PCB

| | |
|--|--|
| Remote Controller Display | L I |
| Applicable Models | RQYQ-PY1 RREQ-PY1 |
| Method of Malfunction Detection | <ul style="list-style-type: none"> ■ Malfunction is detected based on the current value during waveform output before starting compressor. ■ Malfunction is detected based on the value from current sensor during synchronous operation when starting the unit. |
| Malfunction Decision Conditions | <ul style="list-style-type: none"> ■ Overcurrent (OCP) flows during waveform output. ■ Malfunction of current sensor during synchronous operation. ■ IPM failure. |
| Supposed Causes | <ul style="list-style-type: none"> ■ Inverter PCB (A3P) <ul style="list-style-type: none"> ● IPM failure ● Current sensor failure ● Drive circuit failure |

Troubleshooting



Caution

Be sure to turn off power switch before connect or disconnect connector, or parts damage may be occurred.

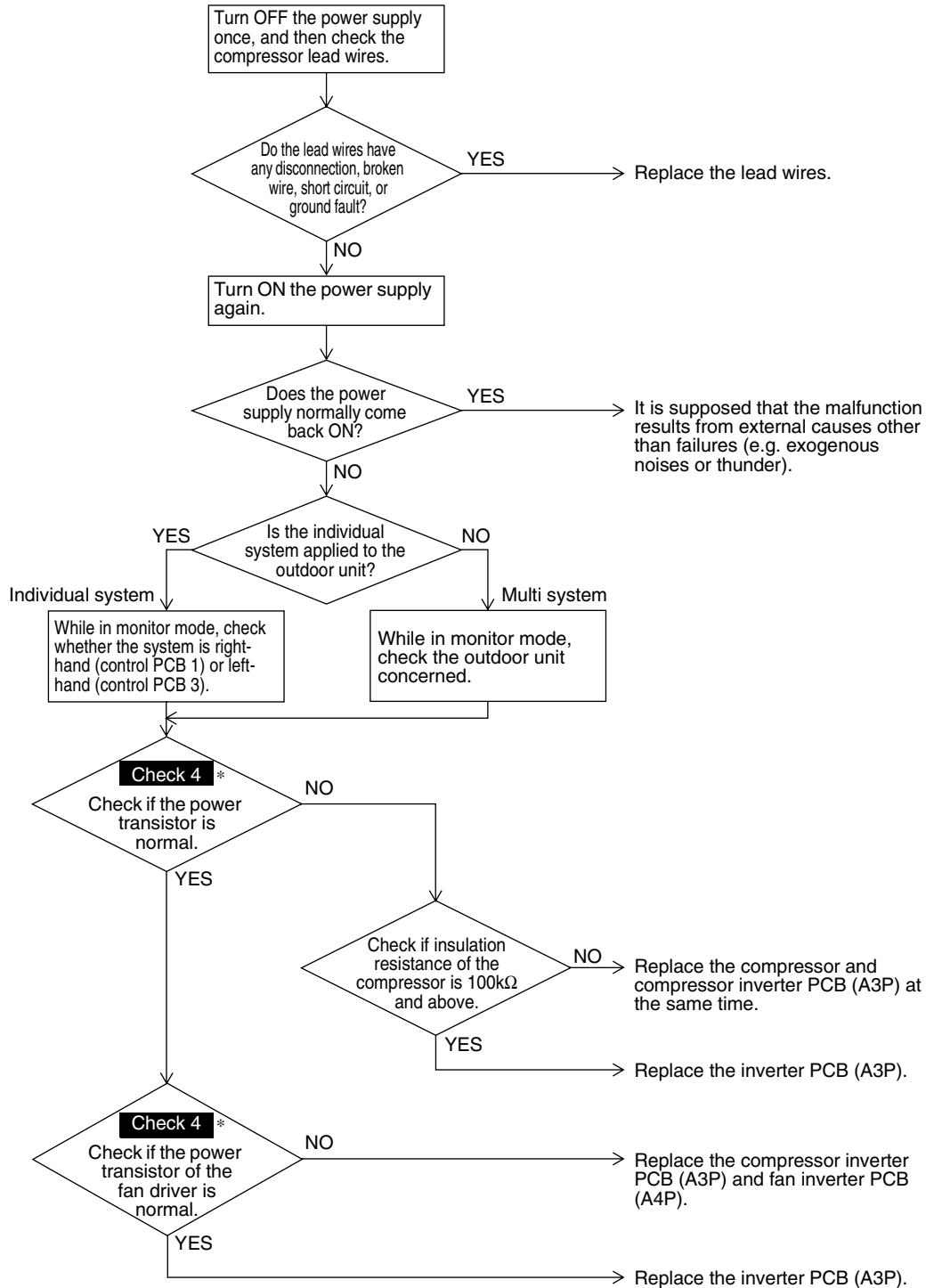

* **Check 4** : Referring to the information on P.192.

2.22 “L4” Outdoor Unit: Malfunction of Inverter Radiating Fin Temperature Rise

| | |
|--|--|
| Remote Controller Display | L4 |
| Applicable Models | RQYQ-PY1 RREQ-PY1 |
| Method of Malfunction Detection | Radiation of compressor inverter PCB. Fin temperature is detected by the thermistor of the radiation fin. |
| Malfunction Decision Conditions | When the temperature of the inverter radiation fin increases above 87°C. |
| Supposed Causes | <ul style="list-style-type: none"> ■ Actuation of fin thermal (Actuates above 87°C) ■ Defect of inverter PCB ■ Defect of fin thermistor |

Troubleshooting



Caution Be sure to turn off power switch before connect or disconnect connector, or parts damage may be occurred.

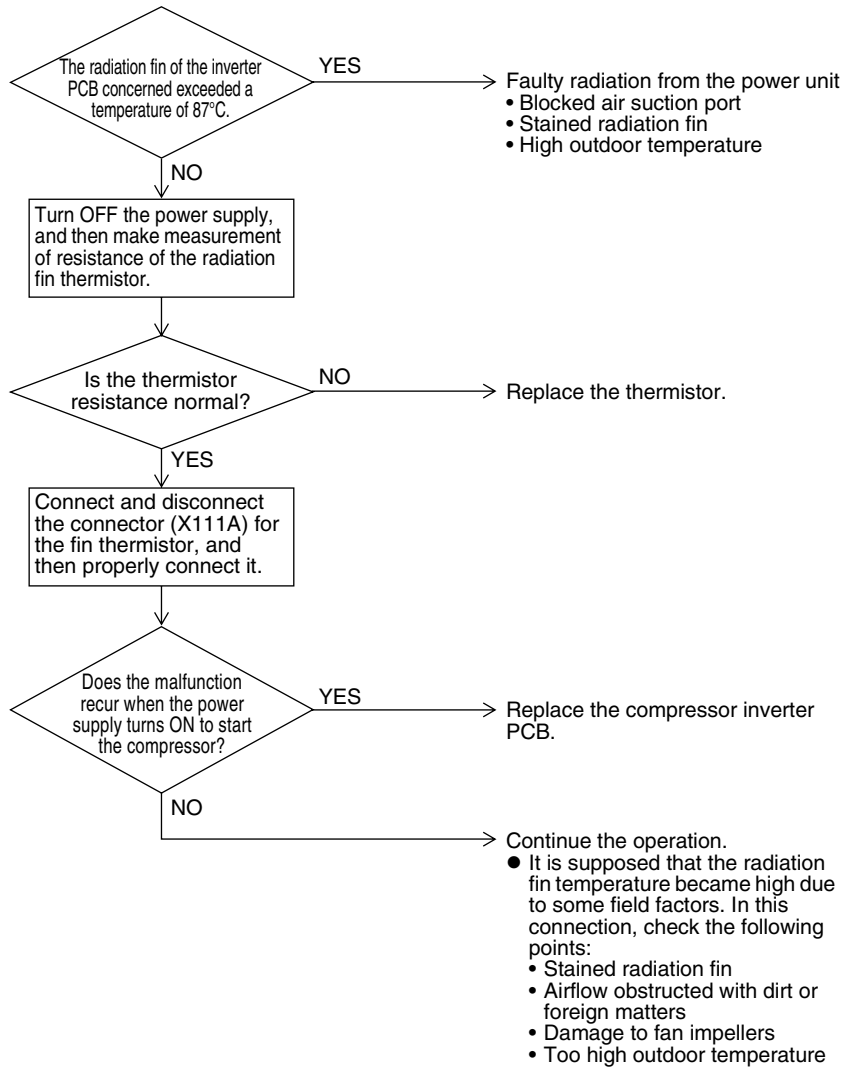

2.23 “L5” Outdoor Unit: Momentary Overcurrent of Inverter Compressor

| | |
|--|---|
| Remote Controller Display | L5 |
| Applicable Models | RQYQ-PY1 RREQ-PY1 |
| Method of Malfunction Detection | Malfunction is detected from the current flowing in the power transistor. |
| Malfunction Decision Conditions | When an excessive current (59.1A) flows in the power transistor. (Instantaneous overcurrent also causes activation.) |
| Supposed Causes | <ul style="list-style-type: none"> ■ Defect of compressor coil (disconnected, defective insulation) ■ Compressor start-up malfunction (mechanical lock) ■ Defect of inverter PCB |

Troubleshooting



Caution

Be sure to turn off power switch before connect or disconnect connector, or parts damage may be occurred.

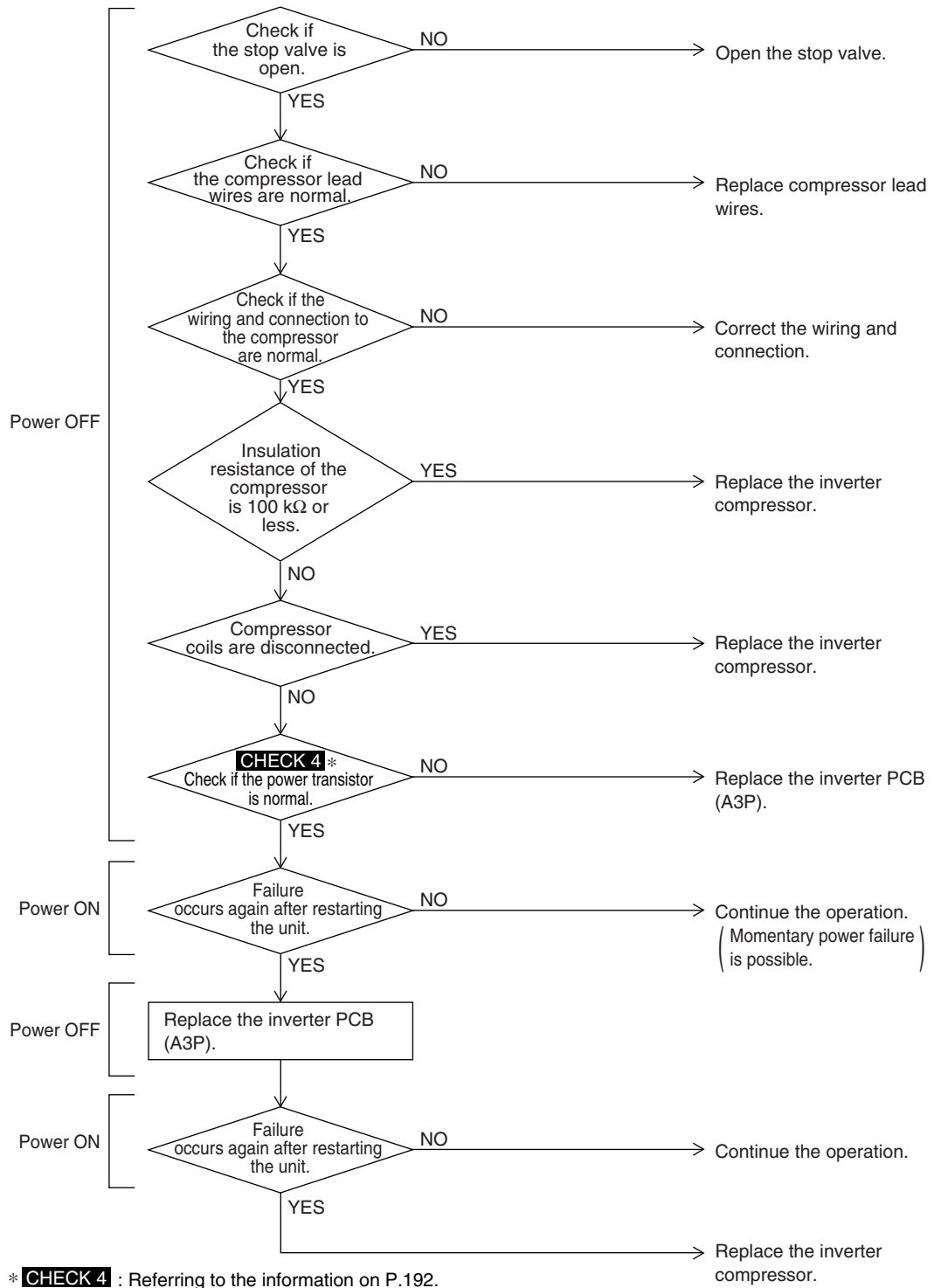

2.24 “L8” Outdoor Unit: Momentary Overcurrent of Inverter Compressor

| | |
|--|---|
| Remote Controller Display | L8 |
| Applicable Models | RQYQ-PY1 RREQ-PY1 |
| Method of Malfunction Detection | Malfunction is detected from the current flowing in the power transistor. |
| Malfunction Decision Conditions | When the inverter secondary current value is below. (1) 33.5A and over continues for 5 seconds. (2) 27.6A and over continues for 260 seconds. |
| Supposed Causes | <ul style="list-style-type: none"> ■ Compressor overload ■ Compressor coil disconnected ■ Defect of wiring or connection to the compressor ■ Defect of inverter PCB |

Troubleshooting

Output current check



Caution Be sure to turn off power switch before connect or disconnect connector, or parts damage may be occurred.

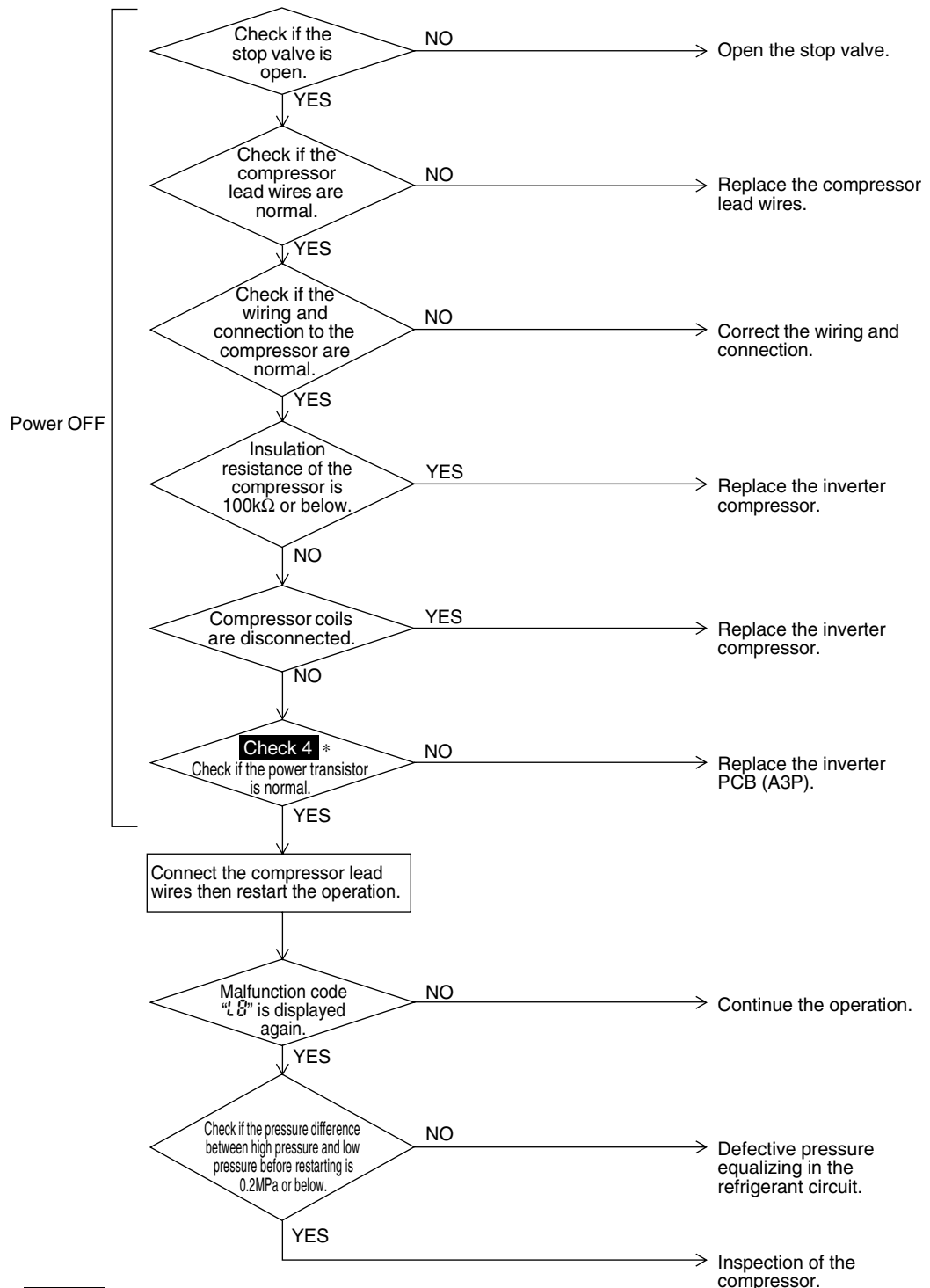

* **Check 4** : Referring to the information on P.192.

2.25 “L9” Outdoor Unit: Inverter Compressor Starting Failure

| | |
|--|---|
| Remote Controller Display | L9 |
| Applicable Models | RQYQ-PY1 RQEQ-PY1 |
| Method of Malfunction Detection | Detect the failure based on the signal waveform of the compressor. |
| Malfunction Decision Conditions | Starting the compressor does not complete. |
| Supposed Causes | <ul style="list-style-type: none">■ Failure to open the stop valve■ Defective compressor■ Wiring connection error to the compressor■ Large pressure difference before starting the compressor■ Defective inverter PCB |

Troubleshooting



Caution

Be sure to turn off power switch before connect or disconnect connector, or parts damage may be occurred.

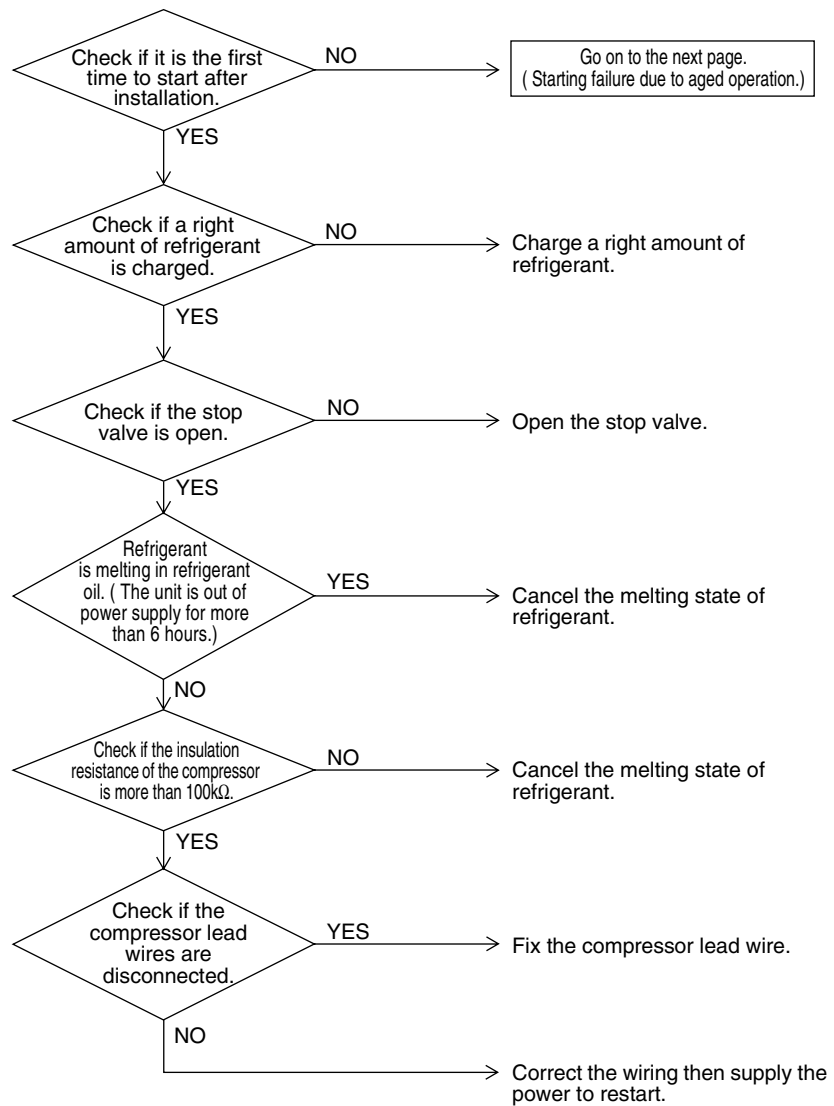

Troubleshooting

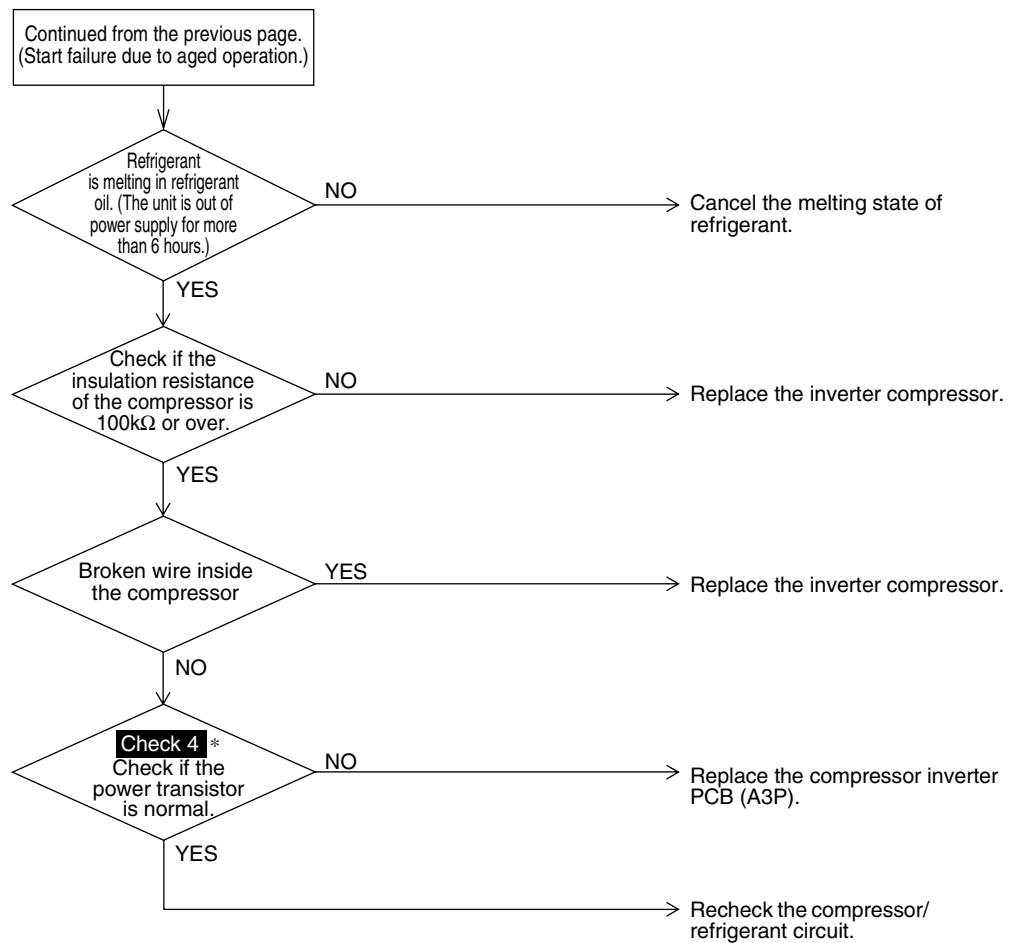

* **Check 4** : Referring to the information on P.192.

2.26 “LL” Outdoor Unit: Malfunction of Transmission between Inverter and Main PCB

| | |
|--|--|
| Remote Controller Display | LL |
| Applicable Models | RQYQ-PY1 RQE-Q-PY1 |
| Method of Malfunction Detection | Check the communication state between inverter PCB and main PCB by micro-computer. |
| Malfunction Decision Conditions | When the correct communication is not conducted in certain period. |
| Supposed Causes | <ul style="list-style-type: none"> ■ Malfunction of connection between the inverter PCB and outdoor main PCB ■ Defect of outdoor main PCB (transmission section) ■ Defect of inverter PCB ■ Defect of noise filter ■ External factor (noise etc.) ■ Faulty inverter compressor ■ Faulty fan motor |

Troubleshooting

**Caution**

Be sure to turn off power switch before connect or disconnect connector, or parts damage may be occurred.

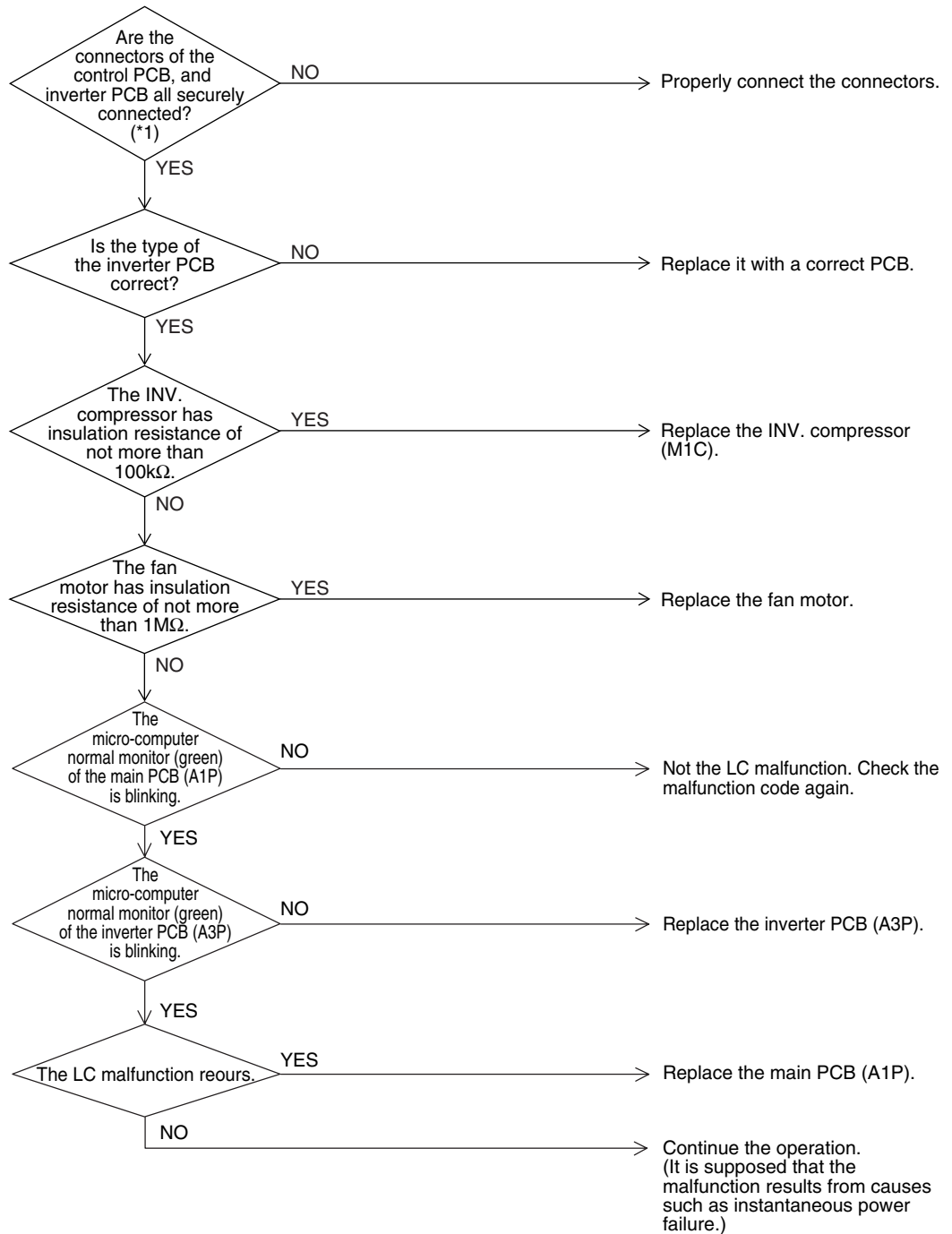

*1. Disconnect the connector once, then reconnect it and check that it is securely connected.

2.27 “P i” Outdoor Unit: Inverter Over-Ripple Protection

| | |
|--|---|
| Remote Controller Display | P i |
| Applicable Models | RQYQ-PY1 RQEQ-PY1 |
| Method of Malfunction Detection | Imbalance in supply voltage is detected in PCB. |
| Malfunction Decision Conditions | When the amplitude of the ripple exceeding 6V is detected. Malfunction is not decided while the unit operation is continued. “P i” will be displayed by pressing the inspection button. |
| Supposed Causes | <ul style="list-style-type: none"> ■ Open phase ■ Voltage imbalance between phases ■ Defect of main circuit capacitor ■ Defect of inverter PCB ■ Defect of K2M relay in inverter PCB ■ Improper main circuit wiring |

Troubleshooting



Caution

Be sure to turn off power switch before connect or disconnect connector, or parts damage may be occurred.

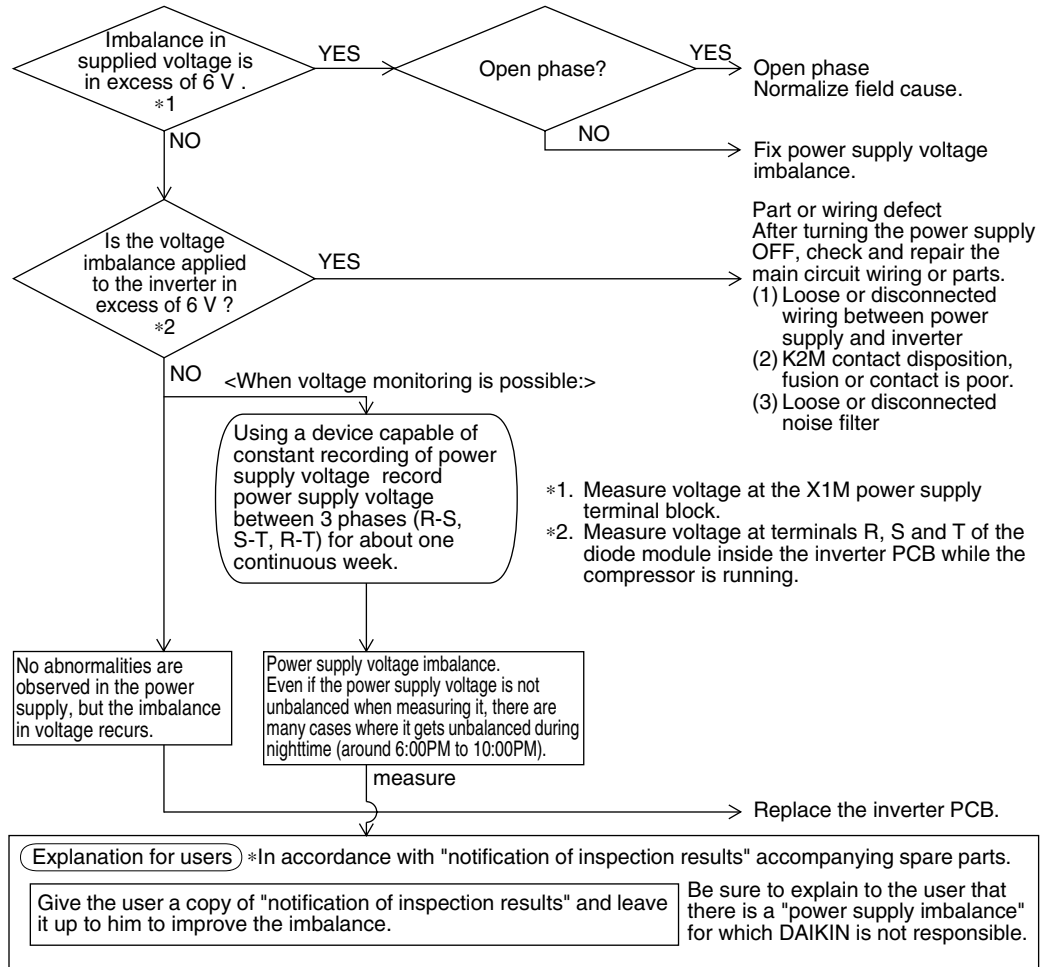

2.28 "P4" Outdoor Unit: Malfunction of Inverter Radiating Fin Temperature Rise Sensor

Remote Controller Display

P4

Applicable Models

RQYQ-PY1
RQEQ-PY1

Method of Malfunction Detection

Resistance of radiation fin thermistor is detected when the compressor is not operating.

Malfunction Decision Conditions

When the resistance value of thermistor becomes a value equivalent to open or short circuited status.
★ Malfunction is not decided while the unit operation is continued.
"P4" will be displayed by pressing the inspection button.

Supposed Causes

- Defect of radiation fin thermistor
- Defect of inverter PCB
- Faulty inverter compressor
- Faulty fan motor

Troubleshooting



Caution

Be sure to turn off power switch before connect or disconnect connector, or parts damage may be occurred.

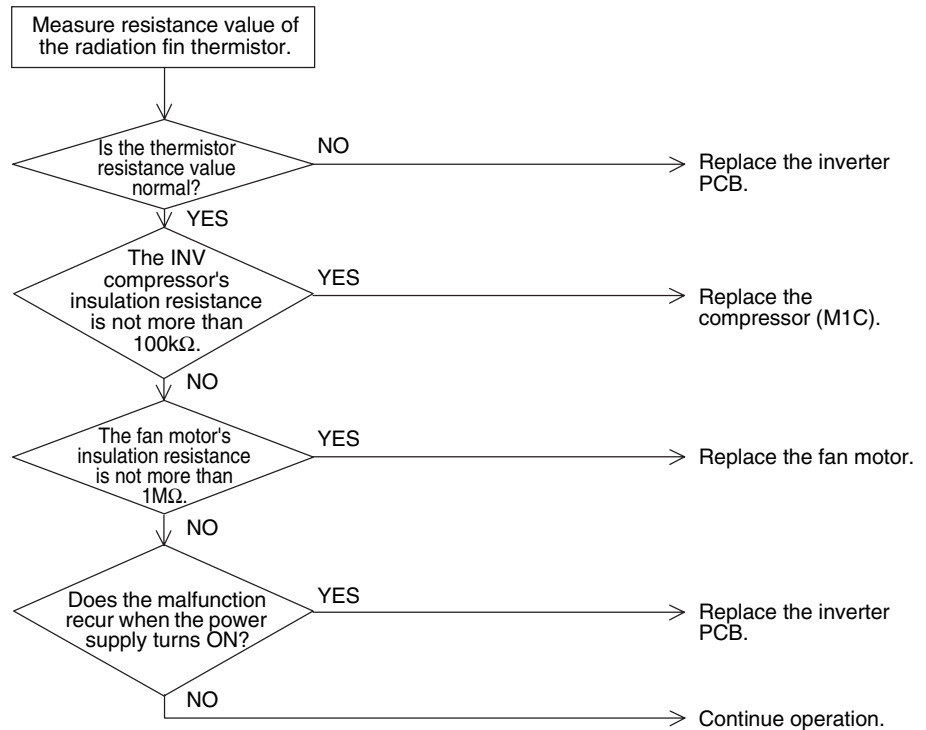

2.29 “PU” Outdoor Unit: Faulty Field Setting after Replacing Main PCB or Faulty Combination of PCB

| | |
|--|---|
| Remote Controller Display | PU |
| Applicable Models | RQYQ-PY1 RREQ-PY1 |
| Method of Malfunction Detection | This malfunction is detected according to communications with the inverter. |
| Malfunction Decision Conditions | Make judgement according to communication data on whether or not the type of the inverter PCB is correct. |
| Supposed Causes | <ul style="list-style-type: none"> ■ Mismatching of type of PCB ■ Faulty (or no) field setting after replacing main PCB |

Troubleshooting



Caution Be sure to turn off power switch before connect or disconnect connector, or parts damage may be occurred.

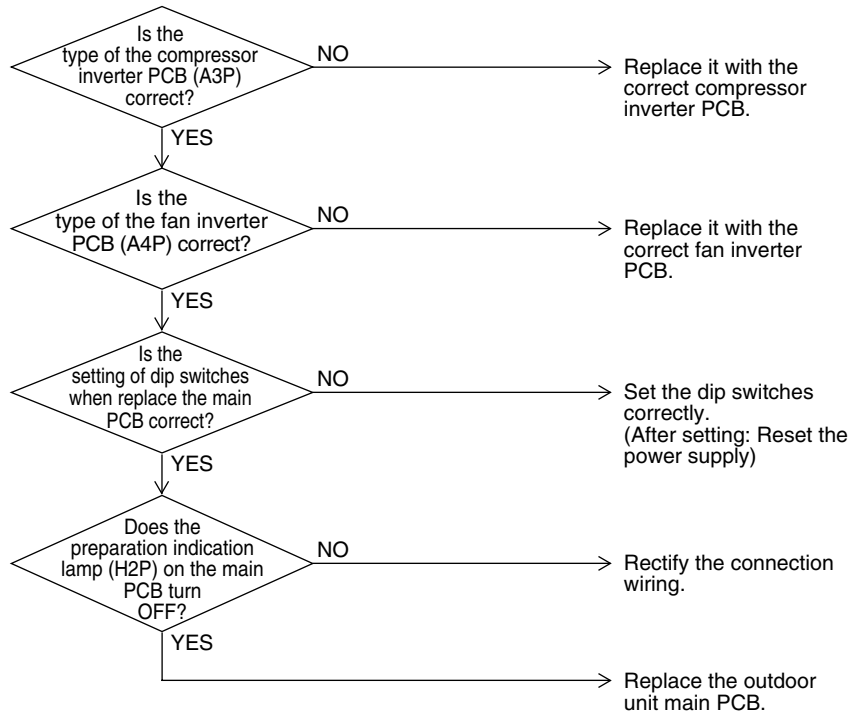

2.30 “U1” Reverse Phase, Open Phase

| | |
|--|---|
| Remote Controller Display | U1 |
| Applicable Models | RQYQ-PY1 RQEQ-PY1 |
| Method of Malfunction Detection | The phase of each phase are detected by reverse phase detection circuit and right phase or reverse phase are judged. |
| Malfunction Decision Conditions | When a power supply is reverse phase, or T phase is open phase. |
| Supposed Causes | <ul style="list-style-type: none"> ■ Power supply reverse phase ■ T phase open phase ■ Defect of outdoor PCB (A1P) |

Troubleshooting

Caution

Be sure to turn off power switch before connect or disconnect connector, or parts damage may be occurred.

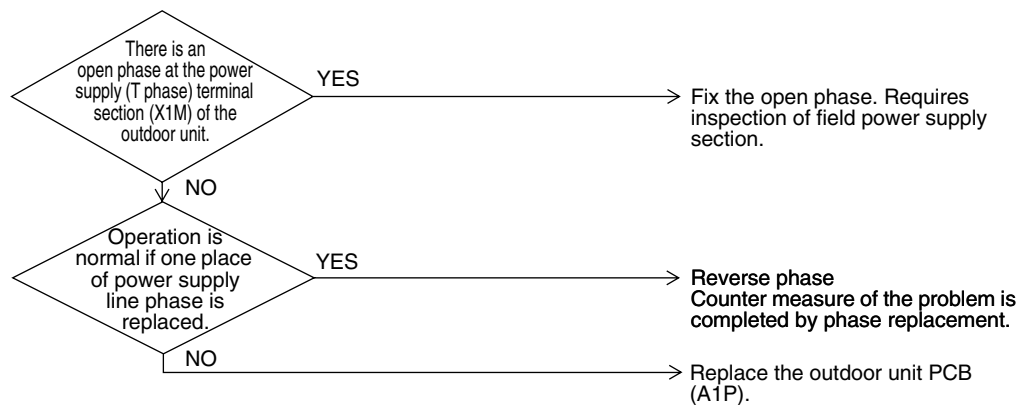

2.31 “U2” Outdoor Unit: Power Supply Insufficient or Instantaneous Failure

| | |
|--|--|
| Remote Controller Display | U2 |
| Applicable Models | RQYQ-PY1 RQEQ-PY1 |
| Method of Malfunction Detection | Detection of voltage of main circuit capacitor built in the inverter and power supply voltage. |
| Malfunction Decision Conditions | When the voltage aforementioned is not less than 190V. |
| Supposed Causes | <ul style="list-style-type: none"> ■ Power supply insufficient ■ Instantaneous power failure ■ Open phase ■ Defect of inverter PCB ■ Defect of outdoor control PCB ■ Faulty compressor ■ Defect of main circuit wiring ■ Faulty fan motor ■ Faulty connection of signal cable |

Troubleshooting

**Caution**

Be sure to turn off power switch before connect or disconnect connector, or parts damage may be occurred.

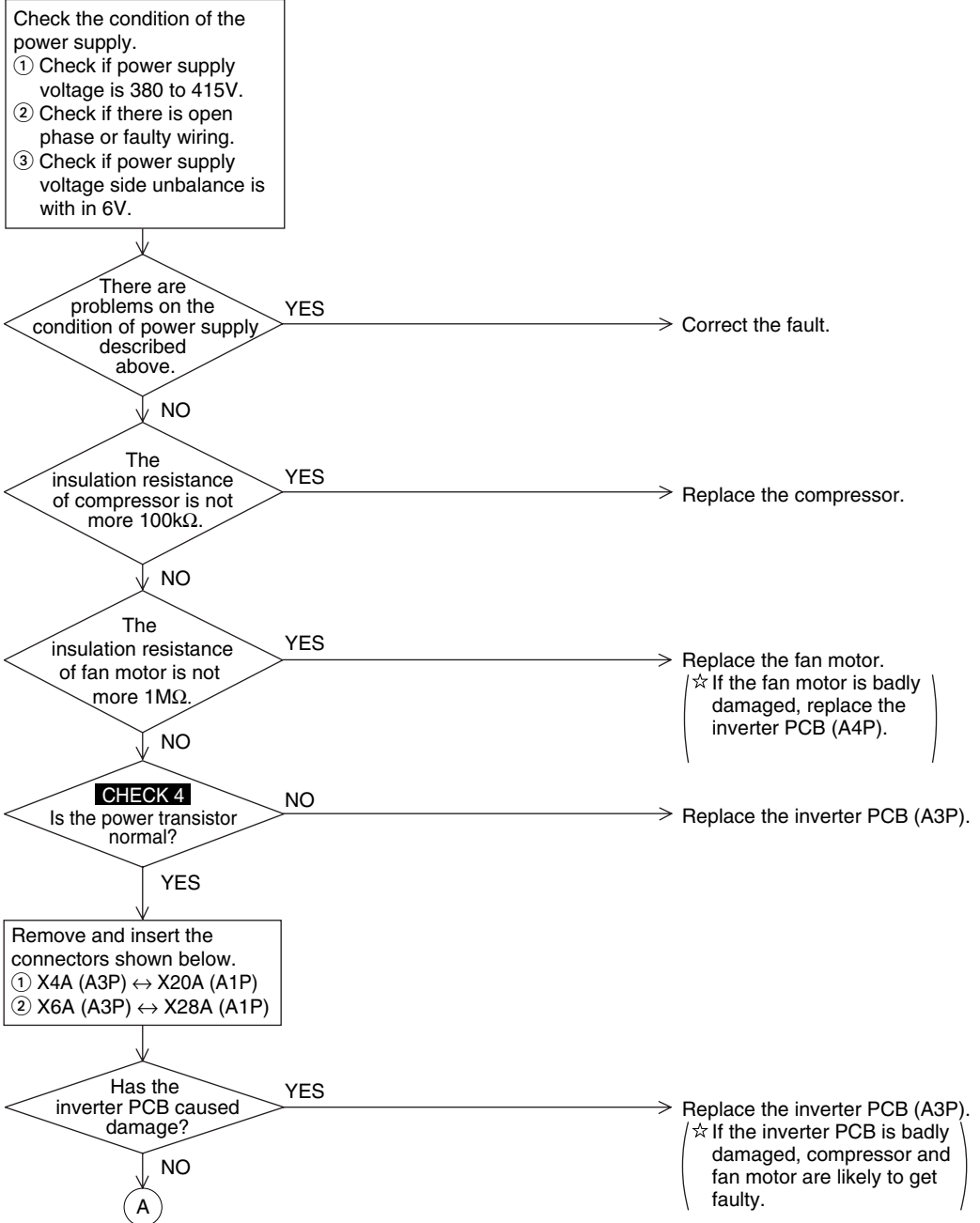

Troubleshooting

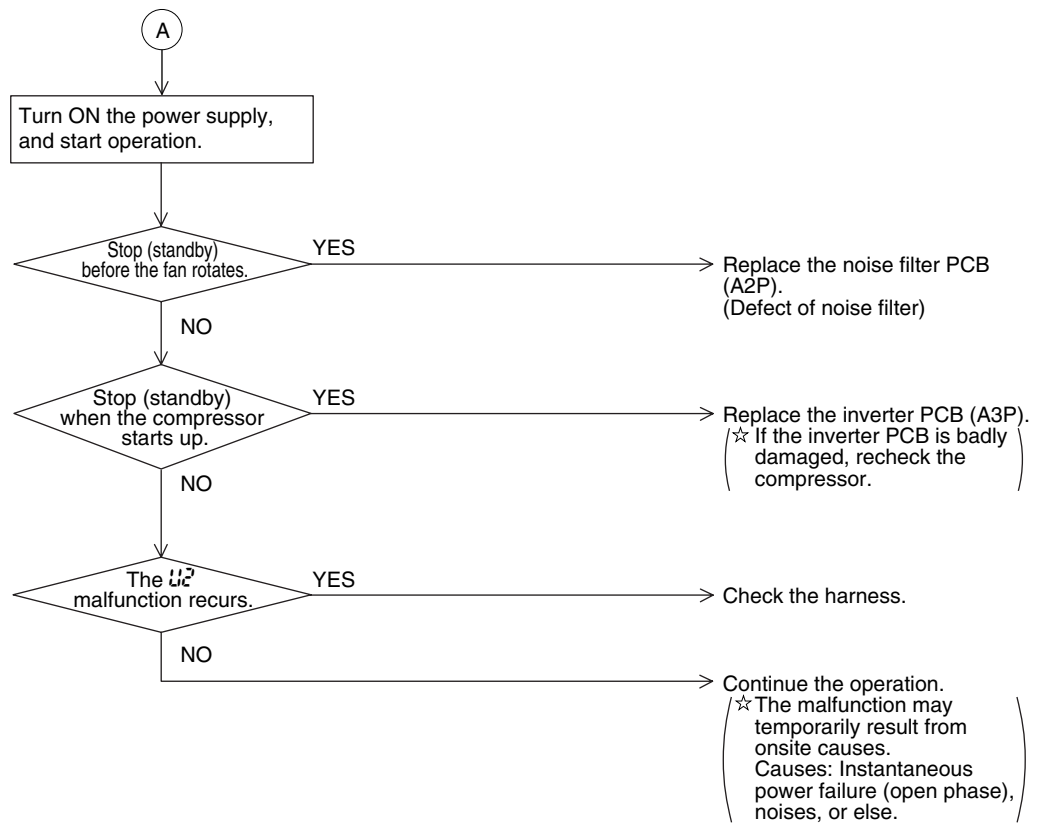

2.32 “U3” Outdoor Unit: Check Operation is not Executed

| | |
|--|--|
| Remote Controller Display | U3 |
| Applicable Models | RQYQ-PY1 RQEQ-PY1 |
| Method of Malfunction Detection | Check operation is executed or not |
| Malfunction Decision Conditions | Malfunction is decided when the unit starts operation without check operation. |
| Supposed Causes | <ul style="list-style-type: none">■ Check operation is not executed. |

Troubleshooting



Caution Be sure to turn off power switch before connect or disconnect connector, or parts damage may be occurred.

Malfunction varies depending on the malfunction detail code. Check the detail code before proceeding to the following step:

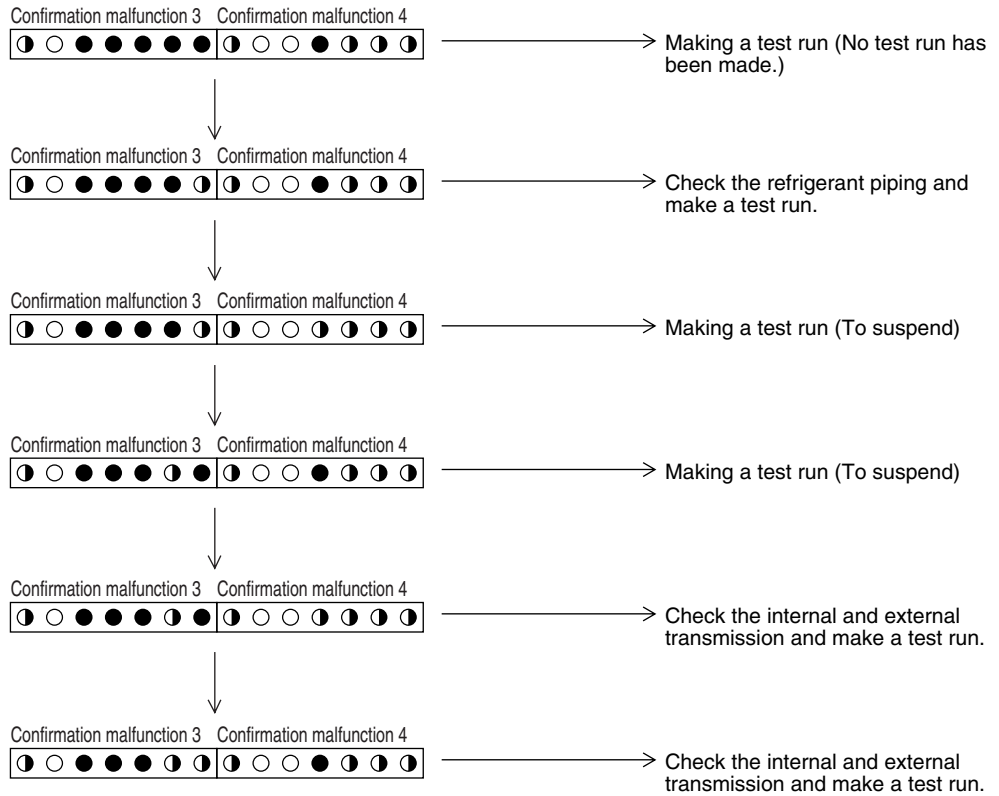

2.33 “U4” Malfunction of Transmission between Indoor Units and Outdoor Units

| | |
|--|--|
| Remote Controller Display | U4 |
| Applicable Models | All indoor unit models RQYQ-PY1 RQEQ-PY1 |
| Method of Malfunction Detection | Check if the transmission between indoor unit and outdoor unit is correctly executed using micro-computer. |
| Malfunction Decision Conditions | When transmission is not carried out normally for a certain amount of time |
| Supposed Causes | <ul style="list-style-type: none"> ■ Indoor to outdoor, outdoor to outdoor transmission wiring F1, F2 disconnection, short circuit or wrong wiring ■ Outdoor unit power supply is OFF ■ System address does not match ■ Defect of outdoor unit main PCB (A1P) ■ Defect of indoor unit PCB |

Troubleshooting



Caution

Be sure to turn off power switch before connect or disconnect connector, or parts damage may be occurred.

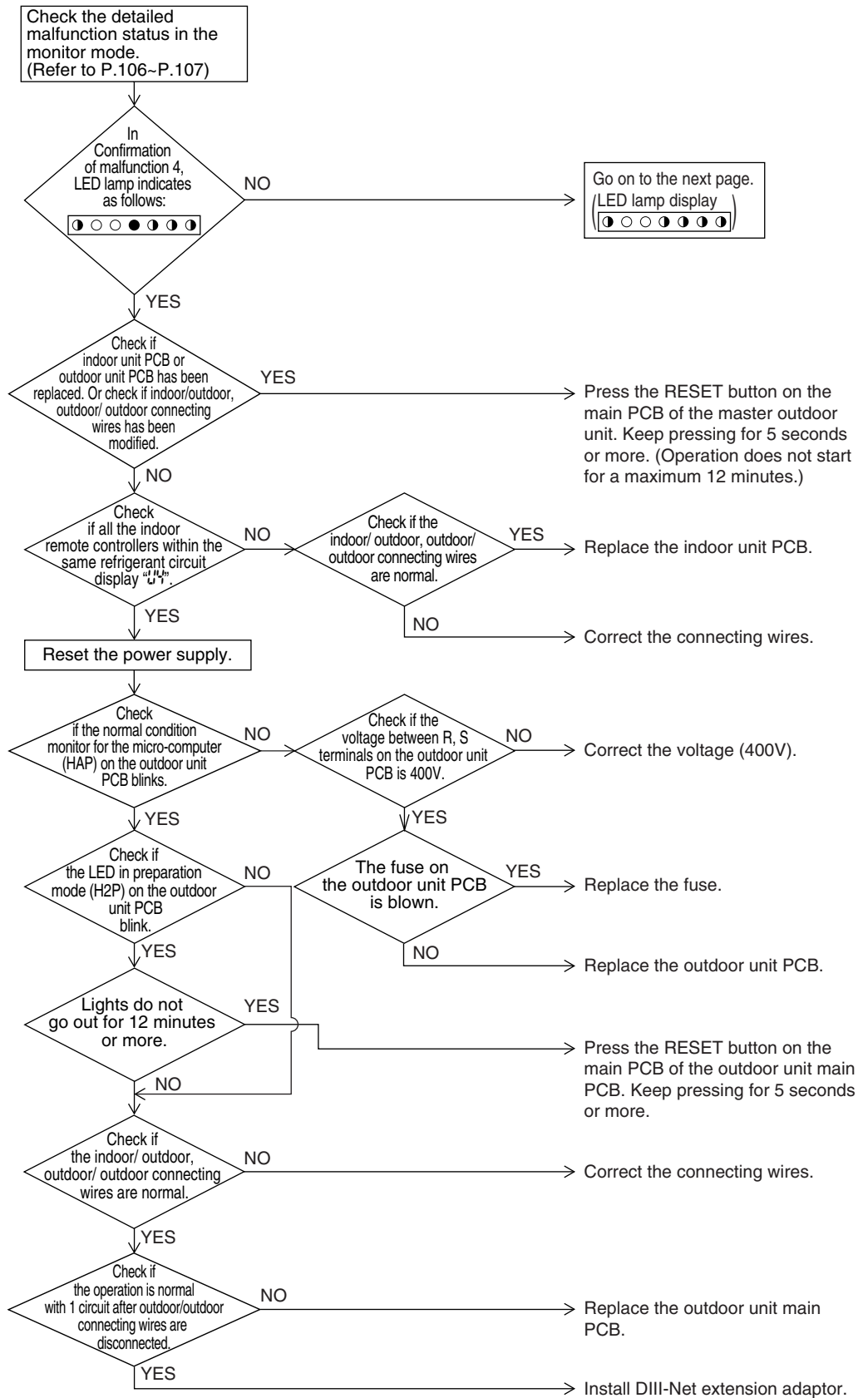

2.34 “U7” Outdoor Unit: Transmission Failure (Across Outdoor Units)

| | |
|--|--|
| Remote Controller Display | U7 |
| Applicable Models | RQYQ-PY1 RQEQ-PY1 |
| Method of Malfunction Detection | Micro-computer checks if transmission between outdoor units is normal. |
| Malfunction Decision Conditions | When transmission is not carried out normally for a certain amount of time |
| Supposed Causes | <ul style="list-style-type: none"> ■ Connection error in connecting wires between outdoor unit and external control adaptor for outdoor unit ■ Connection error in connecting wires across outdoor units ■ Setting error in switching cooling/ heating ■ Unified address setting error for cooling/ heating (function unit, external control adaptor for outdoor unit) ■ Defective outdoor unit PCB (A1P) ■ Defective of external control adaptor for outdoor unit |

Troubleshooting



Caution

Be sure to turn off power switch before connect or disconnect connector, or parts damage may be occurred.

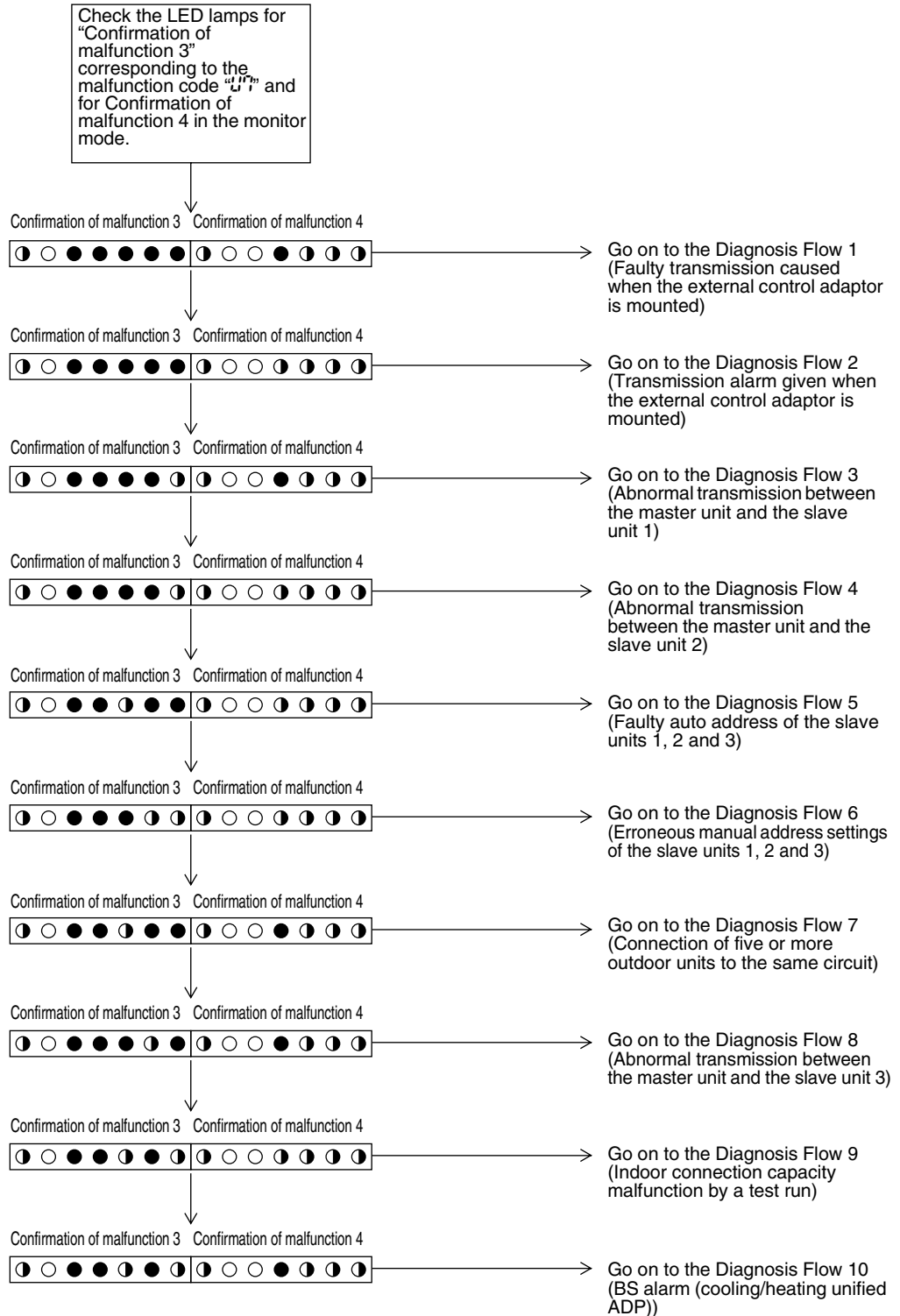

Troubleshooting

 **Caution** Be sure to turn off power switch before connect or disconnect connector, or parts damage may be occurred.

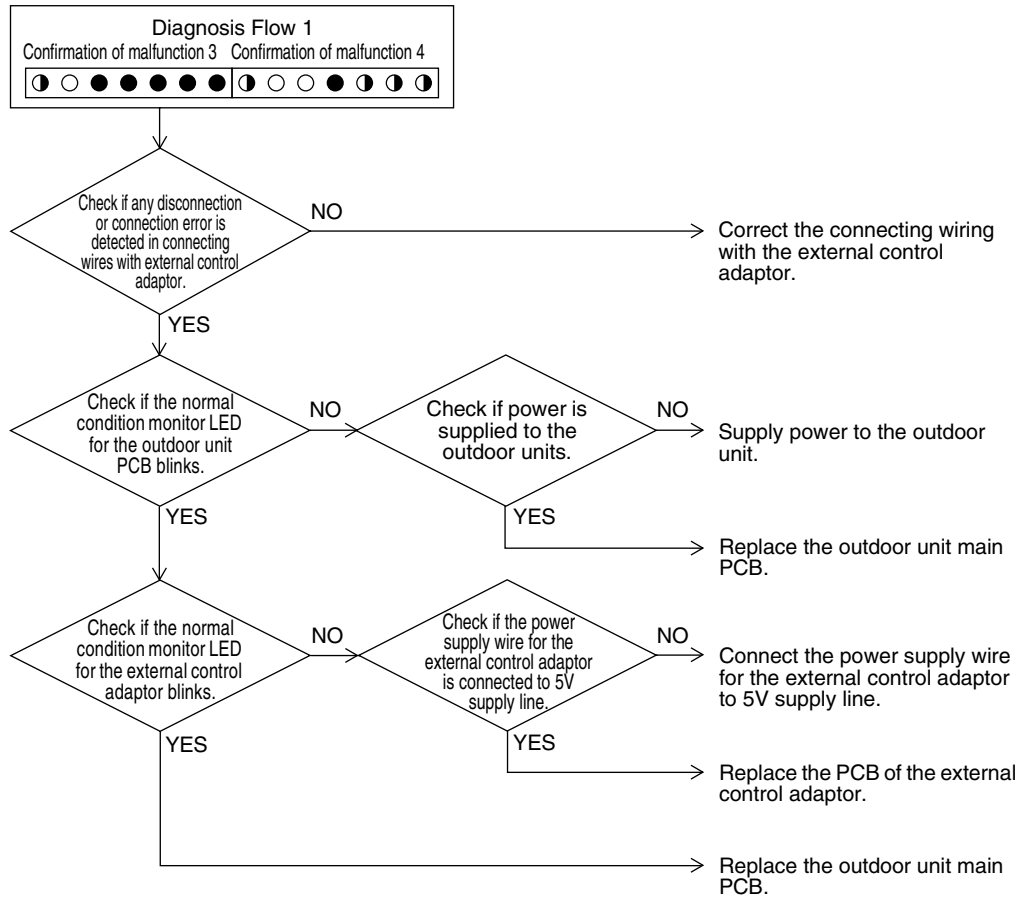

Troubleshooting

 **Caution** Be sure to turn off power switch before connect or disconnect connector, or parts damage may be occurred.

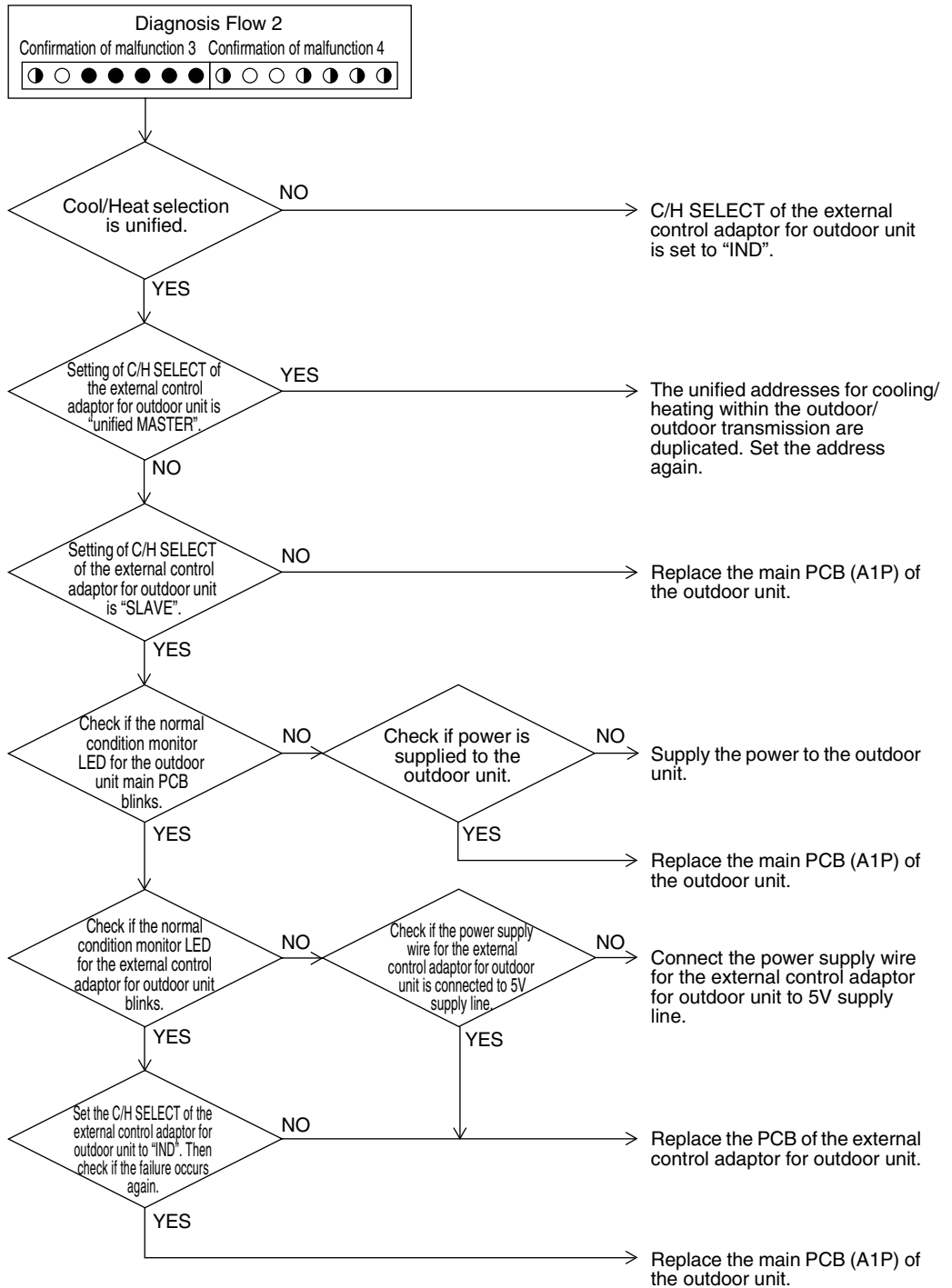

Troubleshooting



Caution Be sure to turn off power switch before connect or disconnect connector, or parts damage may be occurred.

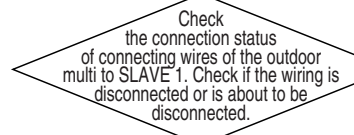
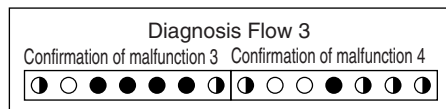

NO → Replace the outdoor unit main PCB of the SLAVE 1.

YES → Correct the connecting wires of the outdoor multi and then reset the power supply.

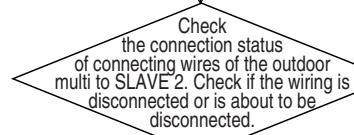
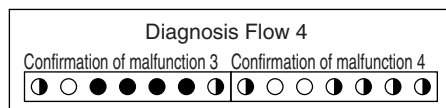

NO → Replace the outdoor unit main PCB of the SLAVE 2.

YES → Correct the connecting wires of the outdoor multi and then reset the power supply.

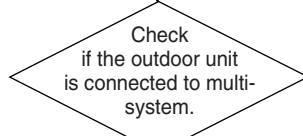
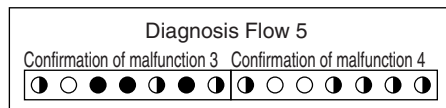

NO → Replace the main PCB (A1P) of the outdoor unit.

YES → Remove the connecting wires of the outdoor multi and then reset the power supply.

Troubleshooting

 **Caution** Be sure to turn off power switch before connect or disconnect connector, or parts damage may be occurred.

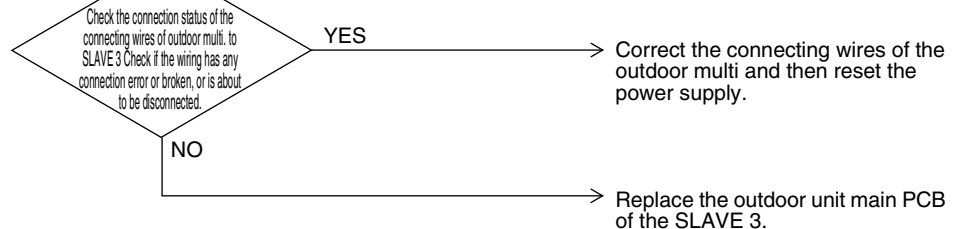
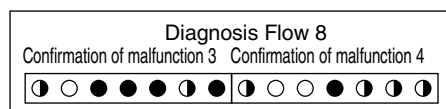
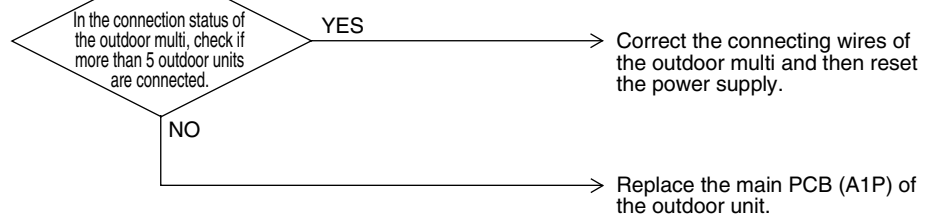
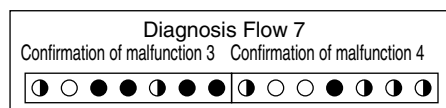
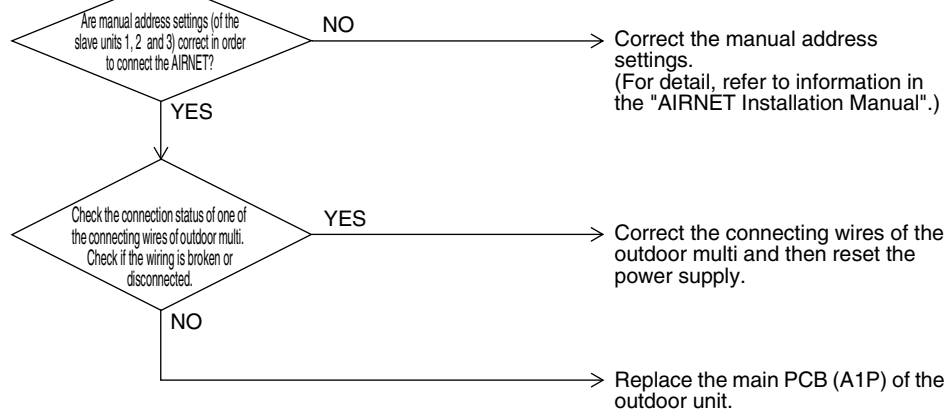
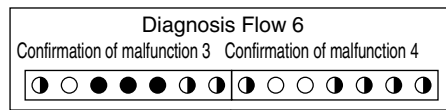

Troubleshooting

 **Caution** Be sure to turn off power switch before connect or disconnect connector, or parts damage may be occurred.

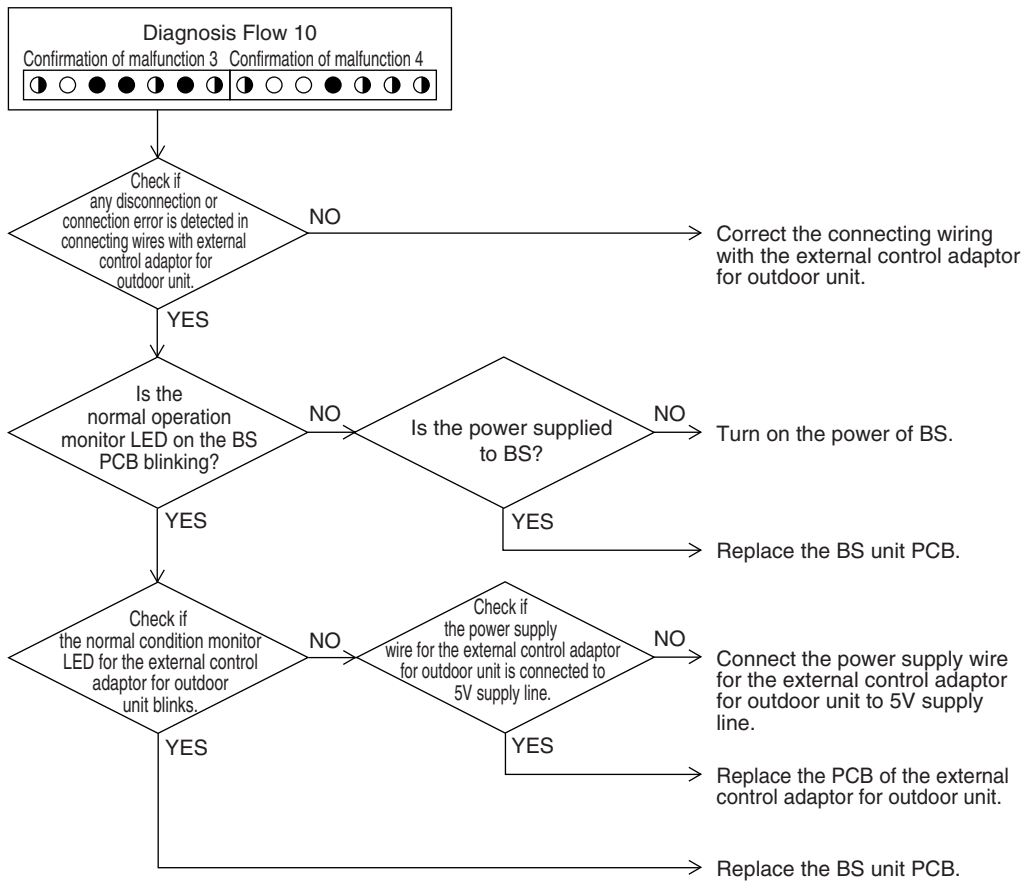
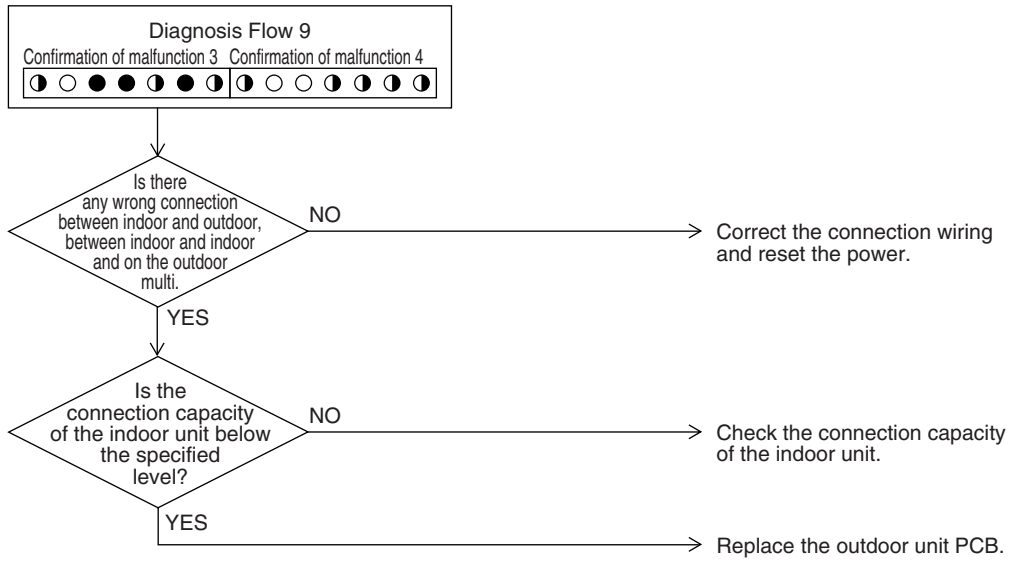

2.35 “08” Indoor Unit: Malfunction of Transmission between Main and Sub Remote Controllers

Remote
Controller
Display

08

Applicable
Models

All indoor unit models

Method of
Malfunction
Detection

In case of controlling with 2-remote controller, check the system using micro-computer if signal transmission between indoor unit and remote controller (main and sub) is normal.

Malfunction
Decision
Conditions

Normal transmission does not continue for specified period.

Supposed
Causes

- Malfunction of transmission between main and sub remote controller
- Connection between sub remote controllers
- Defect of remote controller PCB

Troubleshooting



Caution

Be sure to turn off power switch before connect or disconnect connector, or parts damage may be occurred.

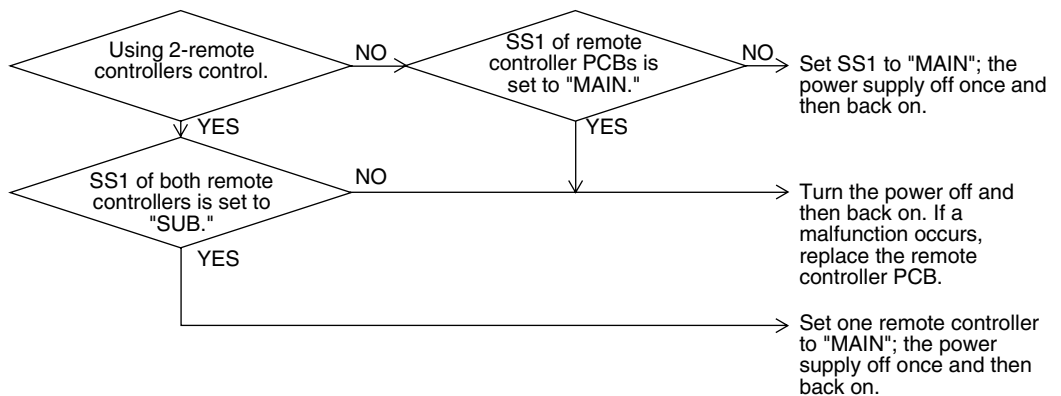

2.36 “U9” Indoor Unit: Malfunction of Transmission between Indoor and Outdoor Units in the Same System

| | |
|--|---|
| Remote Controller Display | U9 |
| Applicable Models | All indoor unit models RQYQ-PY1 RQEQ-PY1 |
| Method of Malfunction Detection | Detect malfunction signal for the other indoor units within the circuit by outdoor unit PCB. |
| Malfunction Decision Conditions | When the malfunction decision is made on any other indoor unit within the system concerned. |
| Supposed Causes | <ul style="list-style-type: none"> ■ Malfunction of transmission within or outside of other system ■ Malfunction of electronic expansion valve in indoor unit of other system ■ Defect of PCB of indoor unit in other system ■ Improper connection of transmission wiring between indoor and outdoor unit |

Troubleshooting

 **Caution** Be sure to turn off power switch before connect or disconnect connector, or parts damage may be occurred.

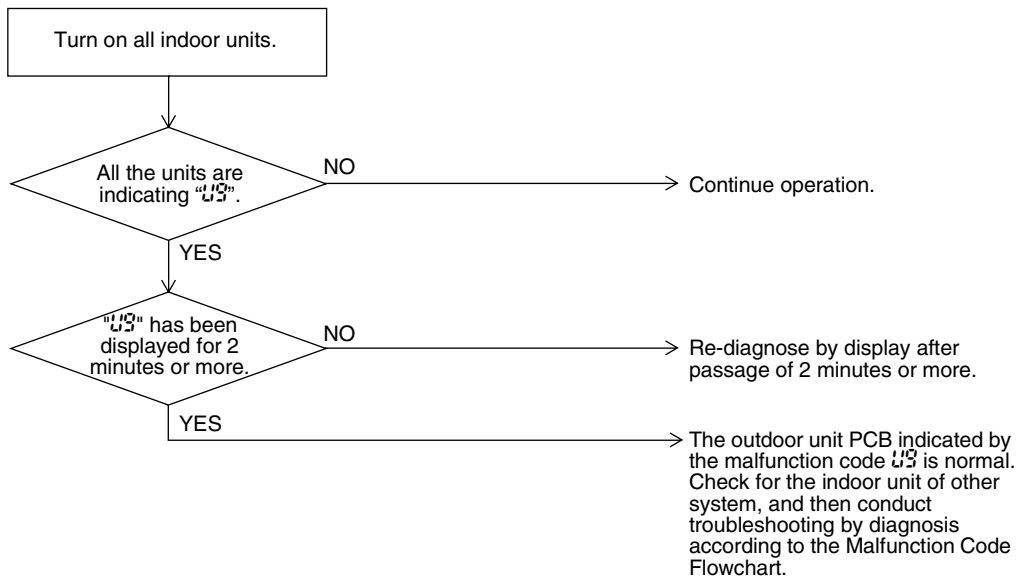

2.37 “UR” Improper Combination of Indoor, BS and Outdoor Units, Indoor Units and Remote Controller

| | |
|--|---|
| Remote Controller Display | UR |
| Applicable Models | All indoor unit models BSVQ100~250PV1 RQYQ-PY1 RREQ-PY1 |
| Method of Malfunction Detection | A difference occurs in data by the type of refrigerant between indoor, BS and outdoor units. The number of indoor units is out of the allowable range. Incorrect signals are transmitted among the indoor unit, BS unit, and outdoor unit. |
| Malfunction Decision Conditions | The malfunction decision is made as soon as either of the abnormalities aforementioned is detected. |
| Supposed Causes | <ul style="list-style-type: none"> ■ Excess of connected indoor units ■ Defect of outdoor unit PCB (A1P) ■ Mismatching of the refrigerant type of indoor and outdoor unit. ■ Setting of outdoor PCB was not conducted after replacing to spare parts PCB. |

Troubleshooting



Caution

Be sure to turn off power switch before connect or disconnect connector, or parts damage may be occurred.

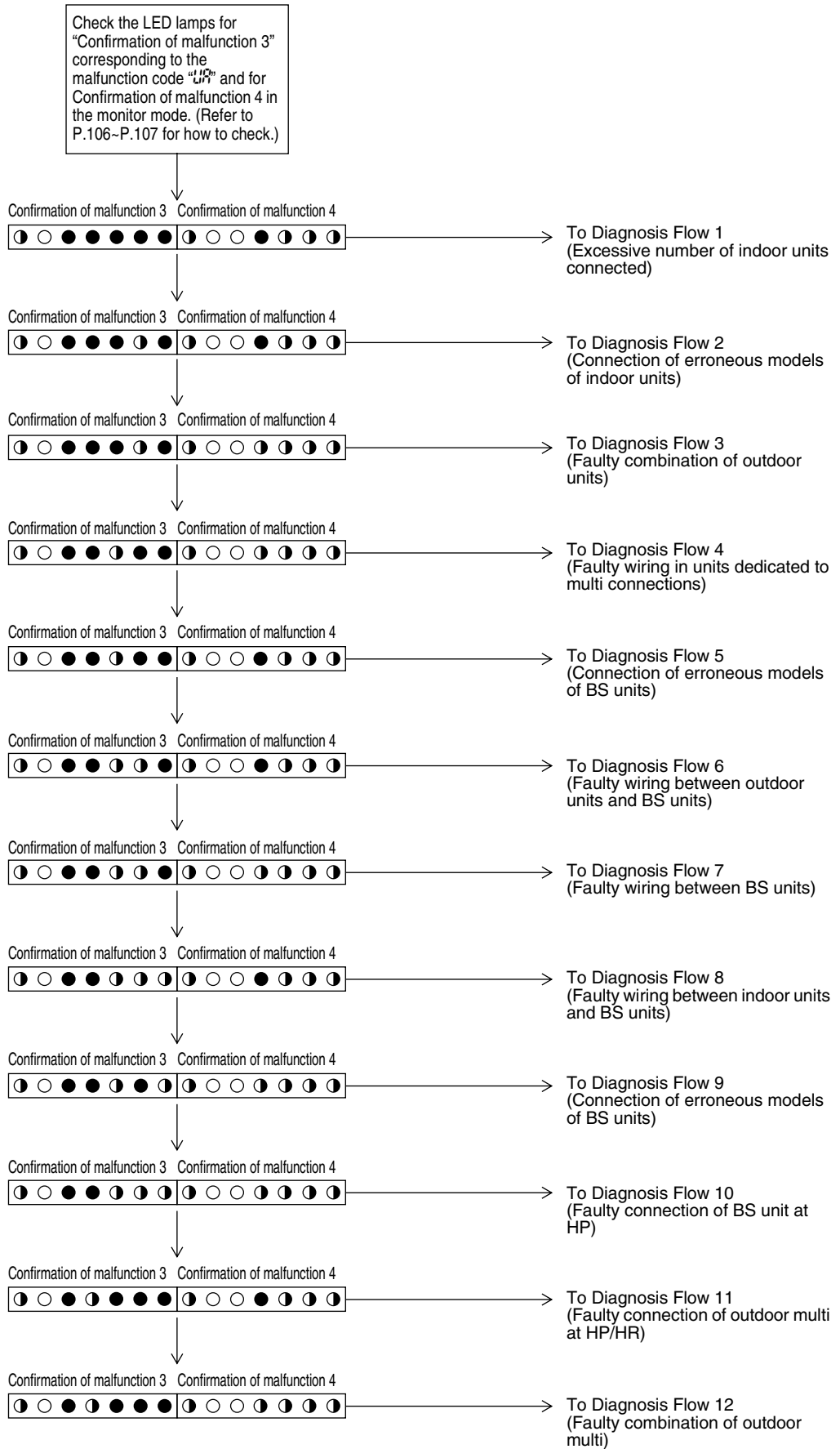

Troubleshooting

 **Caution** Be sure to turn off power switch before connect or disconnect connector, or parts damage may be occurred.

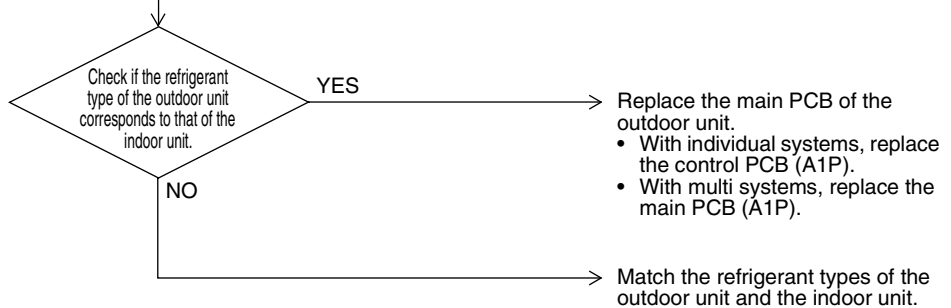
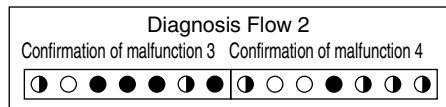
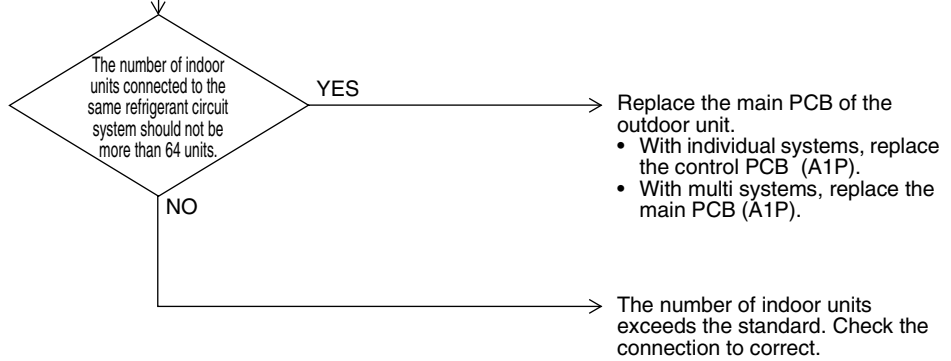
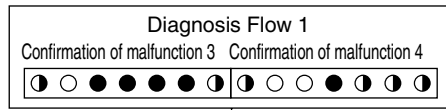

Troubleshooting



Caution

Be sure to turn off power switch before connect or disconnect connector, or parts damage may be occurred.

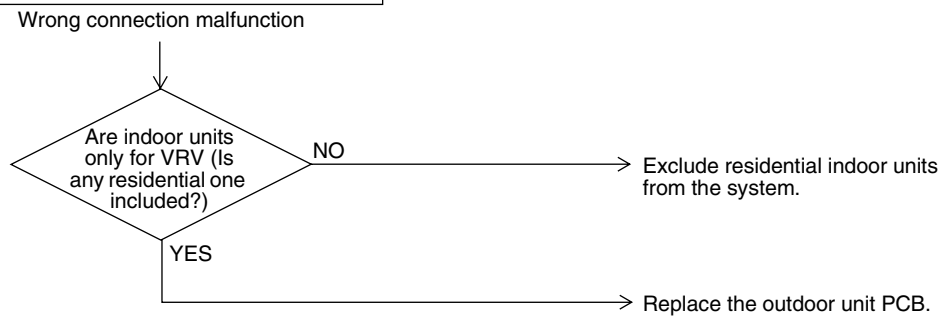
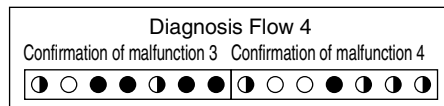
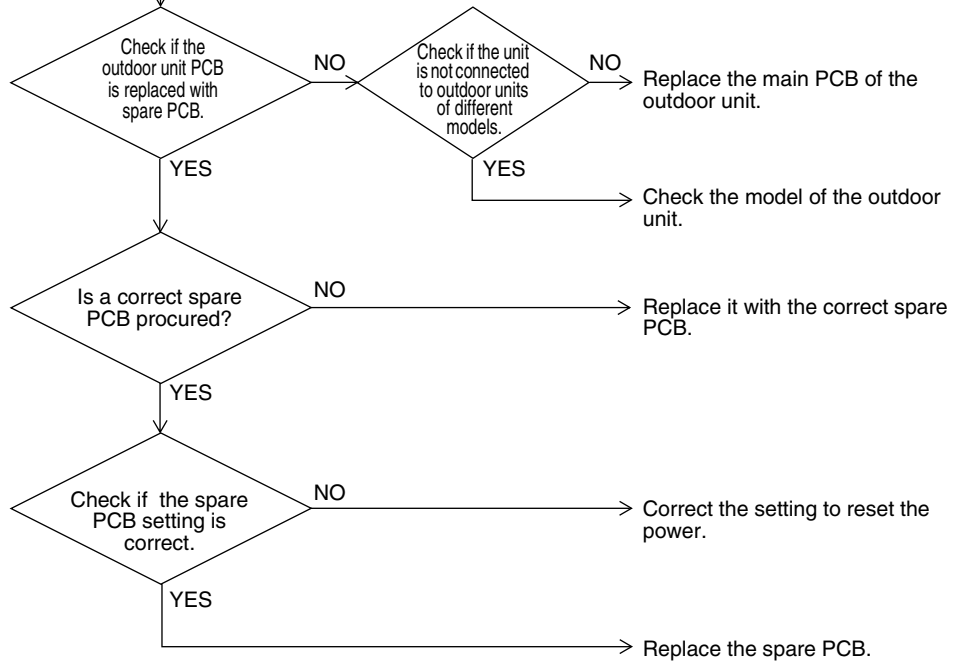
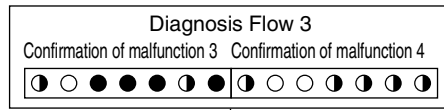

Troubleshooting

 **Caution** Be sure to turn off power switch before connect or disconnect connector, or parts damage may be occurred.

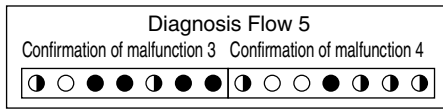

BS malfunction (Excessive number of indoor units connected)

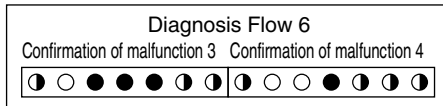
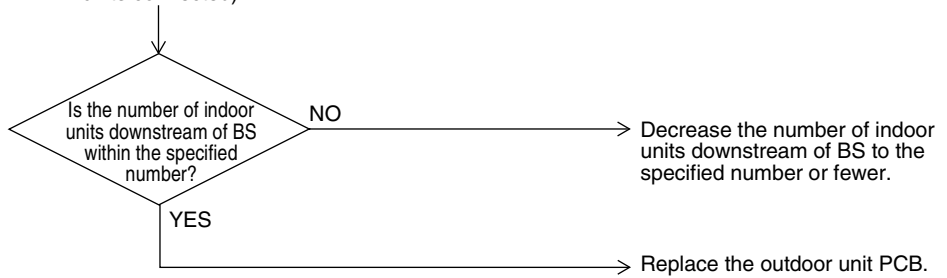

Faulty wiring between outdoor units and BS units.

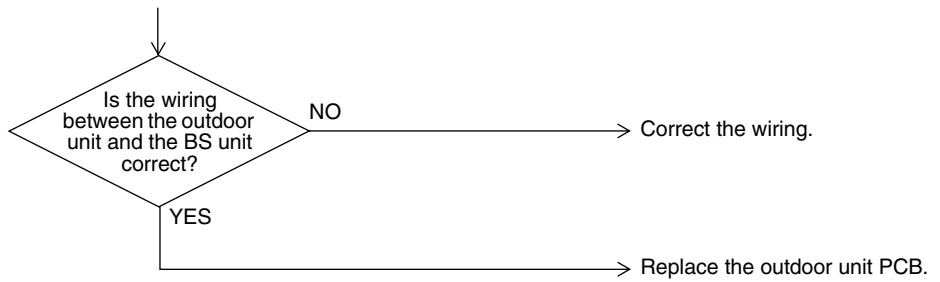

Troubleshooting



Caution

Be sure to turn off power switch before connect or disconnect connector, or parts damage may be occurred.

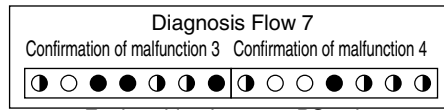

Faulty wiring between BS units

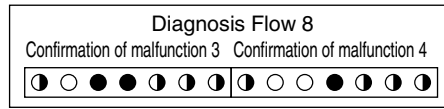
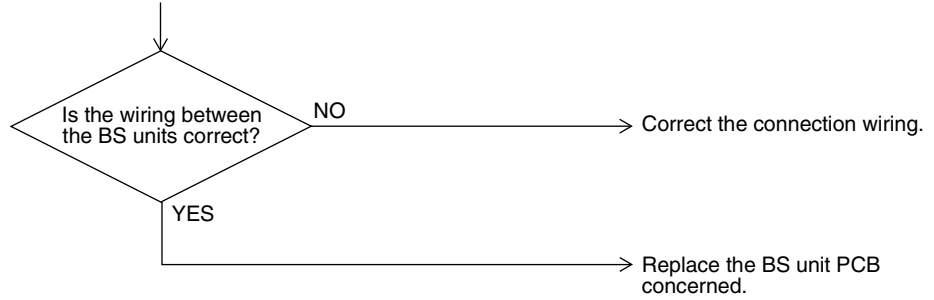

Faulty wiring between indoor units and BS units

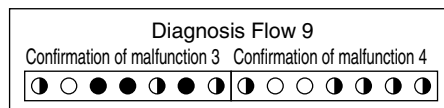
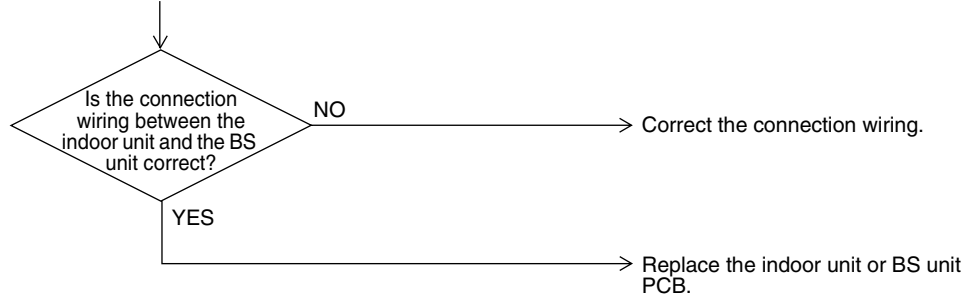

Connection of erroneous models BS units

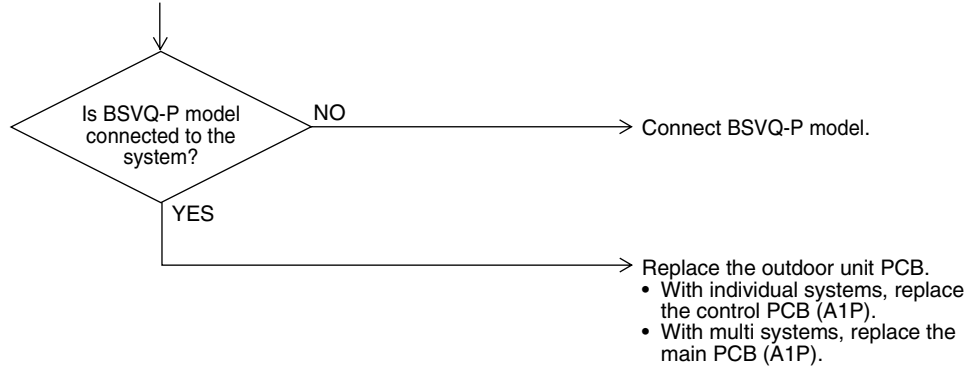

Troubleshooting



Caution

Be sure to turn off power switch before connect or disconnect connector, or parts damage may be occurred.

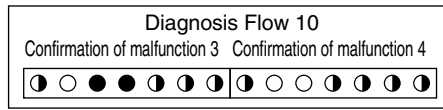

Faulty connection of BS unit at HP

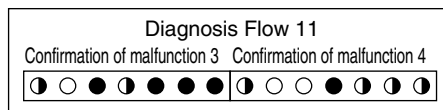
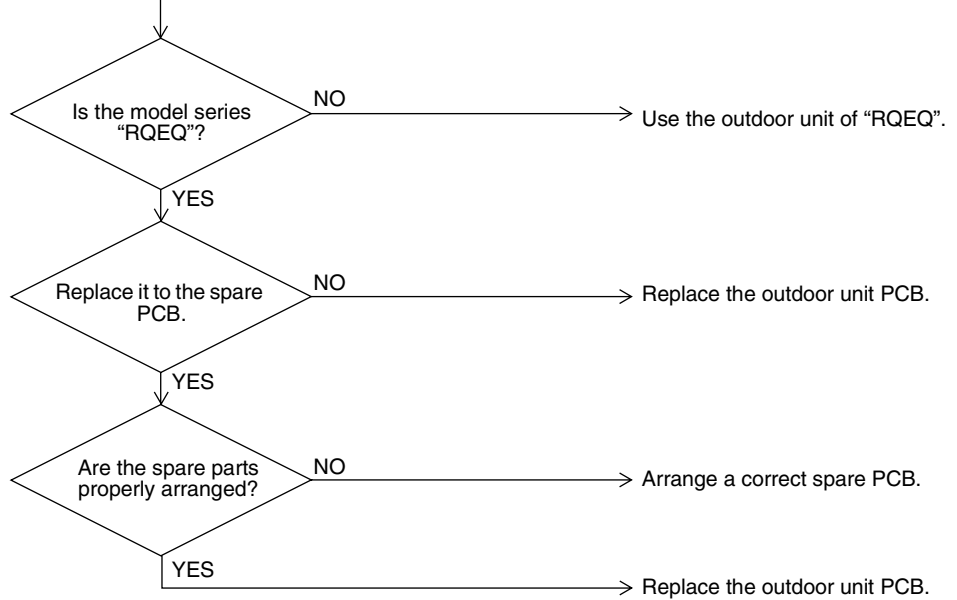

Faulty connection of outdoor multi at HP/HR

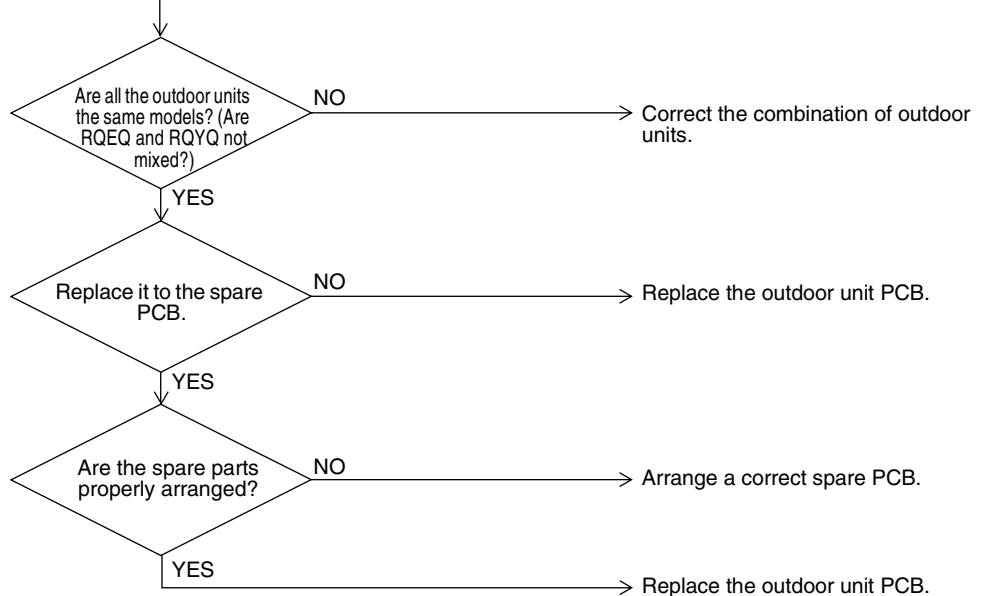

Troubleshooting



Caution

Be sure to turn off power switch before connect or disconnect connector, or parts damage may be occurred.

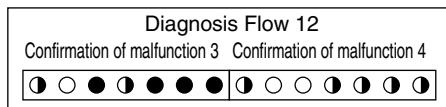

Faulty combination of outdoor multi

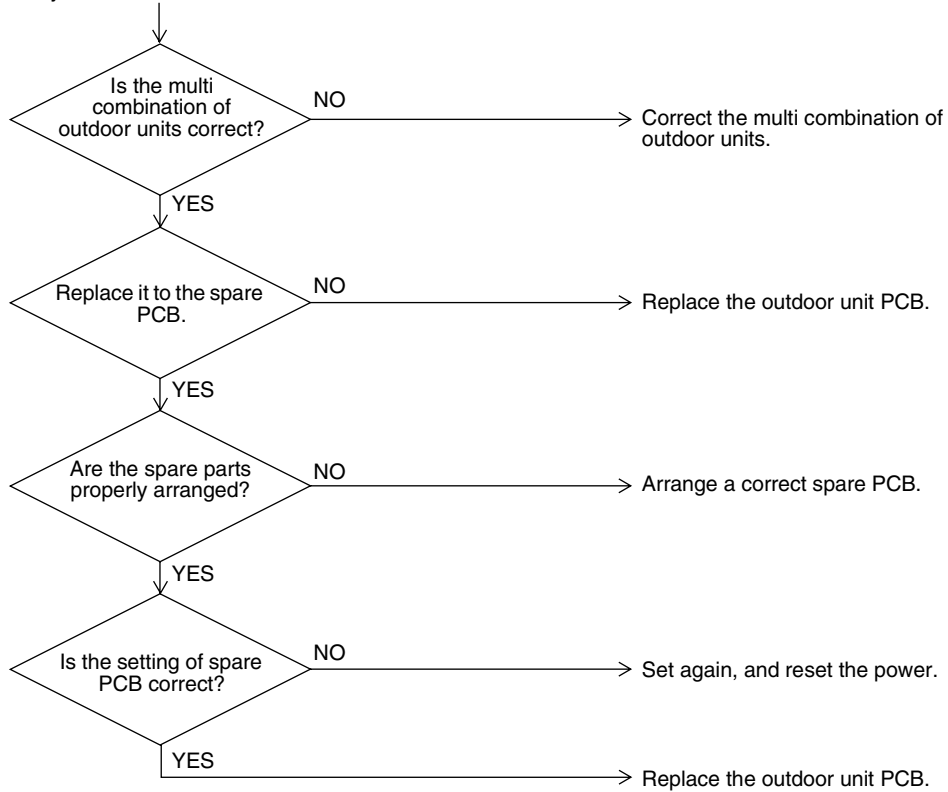

2.38 “U^U” Address Duplication of Centralized Controller

| | |
|--|---|
| Remote Controller Display |  |
| Applicable Models | All indoor unit models Centralized controller |
| Method of Malfunction Detection | The principal indoor unit detects the same address as that of its own on any other indoor unit. |
| Malfunction Decision Conditions | The malfunction decision is made as soon as the abnormality aforementioned is detected. |
| Supposed Causes | <ul style="list-style-type: none"> ■ Address duplication of centralized controller ■ Defect of outdoor unit PCB |

Troubleshooting



Caution

Be sure to turn off power switch before connect or disconnect connector, or parts damage may be occurred.

The centralized address is duplicated.

→ Make setting change so that the centralized address will not be duplicated.

2.39 “UE” Malfunction of Transmission between Centralized Controller and Indoor Unit

| | |
|--|---|
| Remote Controller Display | UE |
| Applicable Models | All indoor unit models intelligent Touch Controller Centralized controller Schedule timer |
| Method of Malfunction Detection | Micro-computer checks if transmission between indoor unit and centralized controller is normal. |
| Malfunction Decision Conditions | When transmission is not carried out normally for a certain amount of time |
| Supposed Causes | <ul style="list-style-type: none"> ■ Malfunction of transmission between optional controllers for centralized control and indoor unit ■ Connector for setting master controller is disconnected. (or disconnection of connector for independent / combined use changeover switch.) ■ Failure of PCB for centralized remote controller ■ Defect of indoor unit PCB |

Troubleshooting

**Caution**

Be sure to turn off power switch before connect or disconnect connector, or parts damage may be occurred.

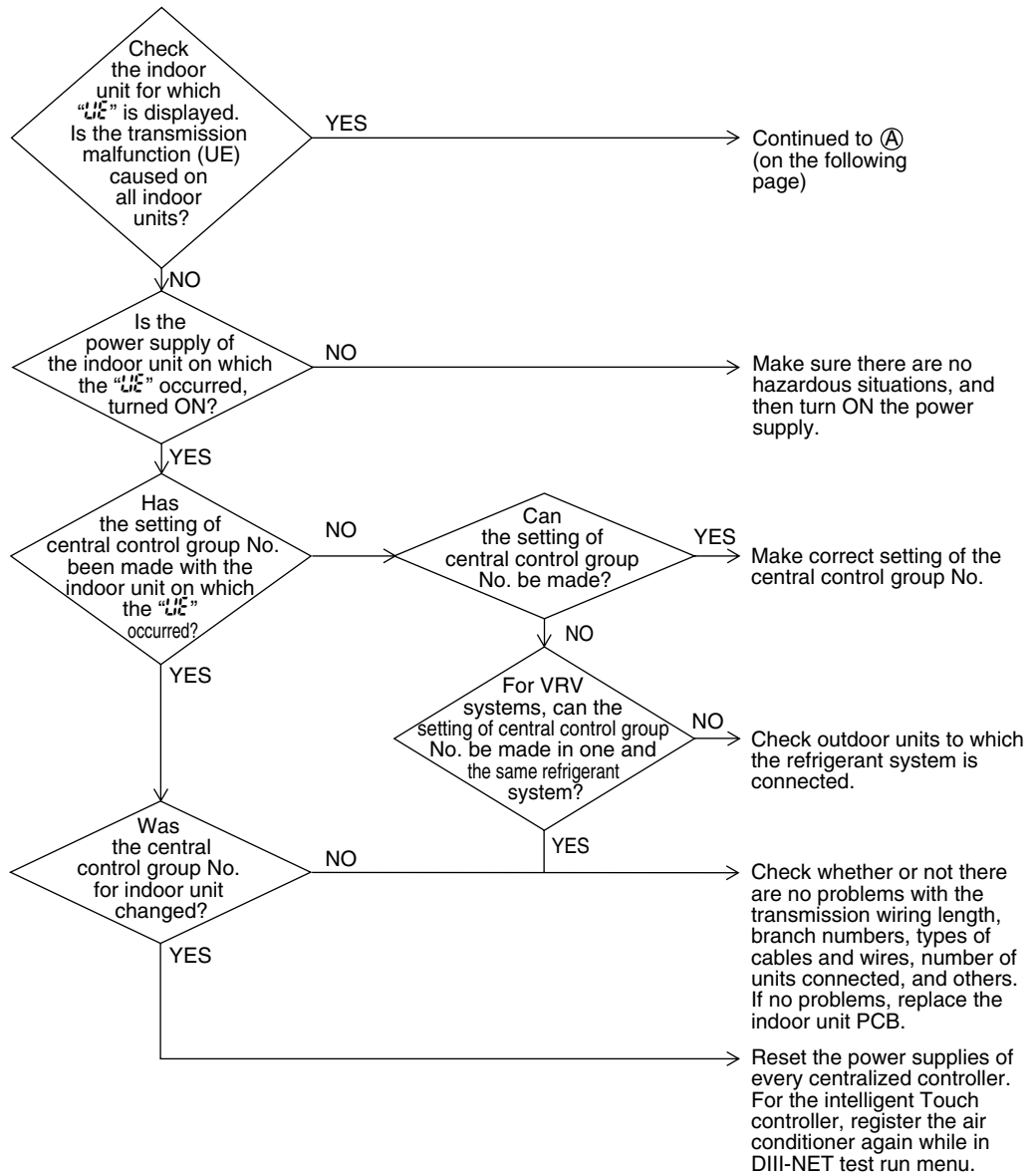

Troubleshooting

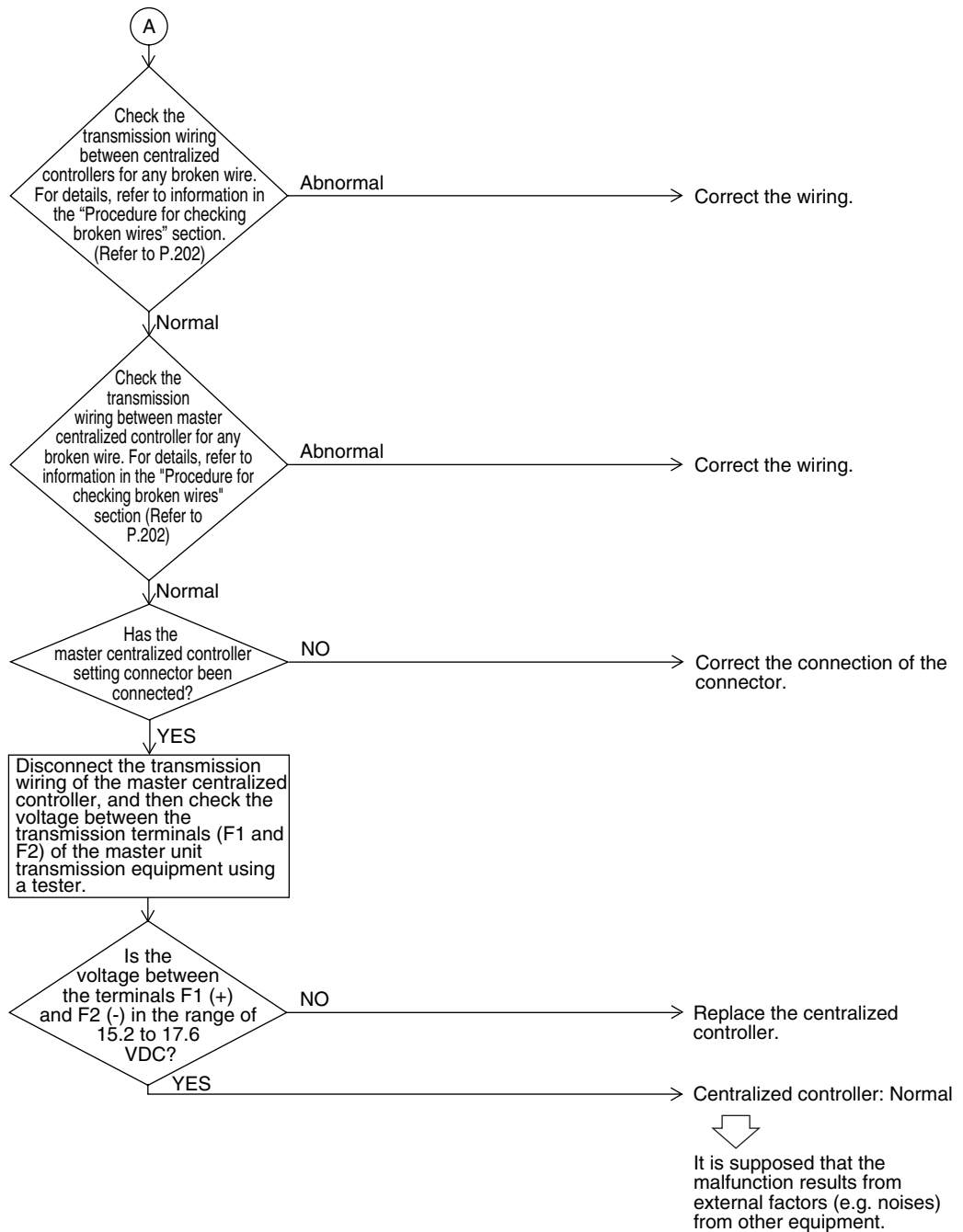

2.40 “UF” System is not Set yet

| | |
|--|--|
| Remote Controller Display |  |
| Applicable Models | All indoor unit models RQYQ-PY1 RQEQ-PY1 |
| Method of Malfunction Detection | On check operation, the number of indoor units in terms of transmission is not corresponding to that of indoor units that have made changes in temperature. |
| Malfunction Decision Conditions | The malfunction is determined as soon as the abnormality aforementioned is detected through checking the system for any erroneous connection of units on the check operation. |
| Supposed Causes | <ul style="list-style-type: none"> ■ Improper connection of transmission wiring between indoor-outdoor units and outdoor-outdoor units ■ Failure to execute check operation ■ Defect of indoor unit PCB ■ Stop valve is left in closed |

Troubleshooting

Caution

Be sure to turn off power switch before connect or disconnect connector, or parts damage may be occurred.

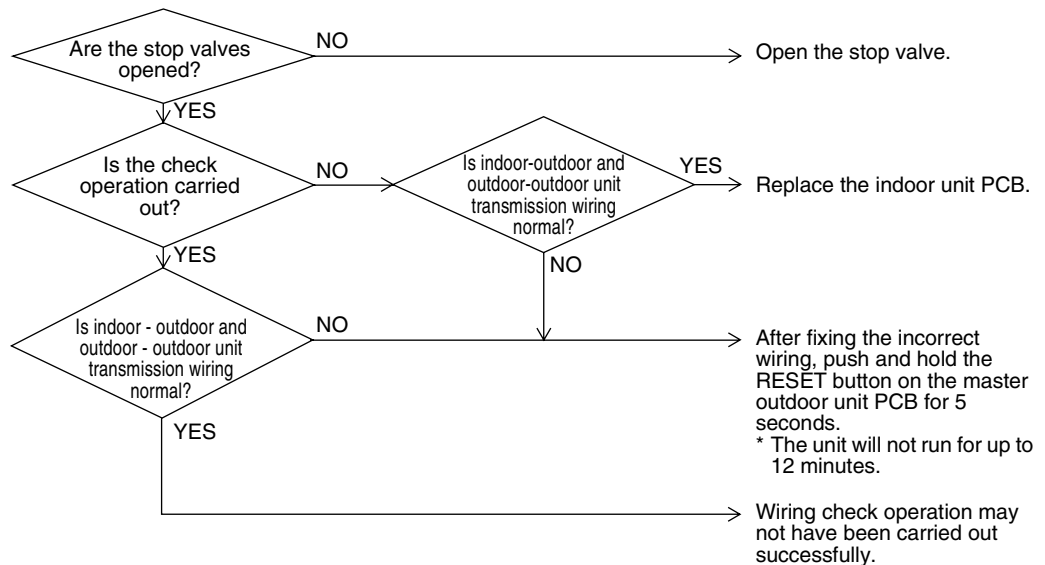

2.41 “UH” Malfunction of System, Refrigerant System Address Undefined

| | |
|--|---|
| Remote Controller Display | UH |
| Applicable Models | All indoor unit models RQYQ-PY1 RQEQ-PY1 |
| Method of Malfunction Detection | Detect an indoor unit with no auto address setting. |
| Malfunction Decision Conditions | The malfunction decision is made as soon as the abnormality aforementioned is detected. |
| Supposed Causes | <ul style="list-style-type: none"> ■ Improper connection of transmission wiring between indoor-outdoor units and outdoor-outdoor units ■ Defect of indoor unit PCB ■ Defect of outdoor unit main PCB (A1P) |

Troubleshooting

**Caution**

Be sure to turn off power switch before connect or disconnect connector, or parts damage may be occurred.

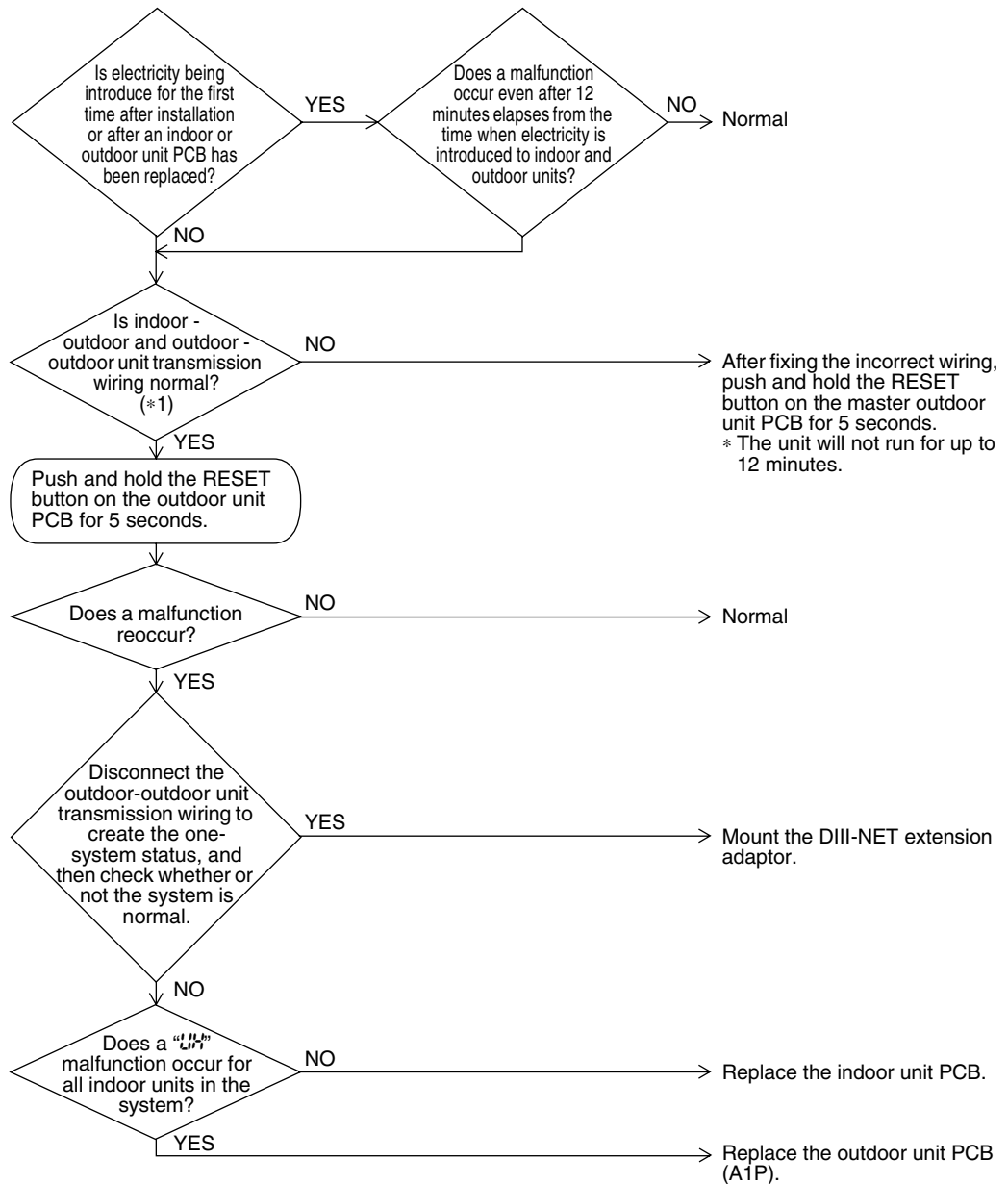

*1: Check the correct wiring "indoor-outdoor" and "outdoor-outdoor" by Installation Manual.

*2: What is Auto Address?

This is the address automatically assigned to indoor units and outdoor units after initial power supply upon installation, or after executing rewiring (Keep pressing the **RESET** button for more than 4 seconds).

CHECK 1 Check for causes of rise in high pressure

Referring to the Fault Tree Analysis (FTA) shown below, probe the faulty points.

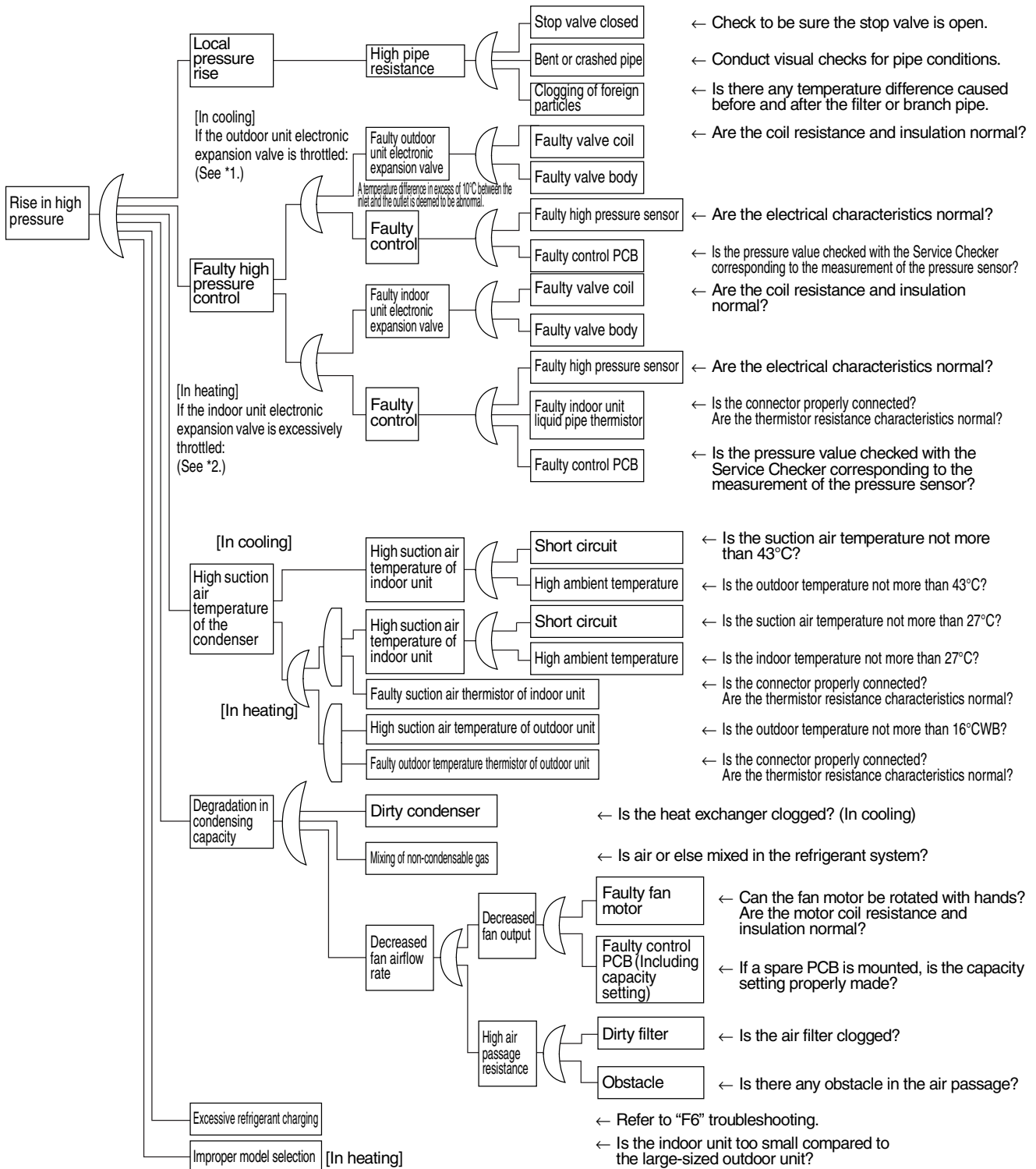

*1: In cooling, it is normal if the outdoor unit electronic expansion valve (EVM) is fully open.

*2: In heating, the indoor unit electronic expansion valve is used for "subcooled degree control". (For details, refer to "Electronic Expansion Valve Control".)

CHECK 2 Check for causes of drop in low pressure

Referring to the Fault Tree Analysis (FTA) shown below, probe the faulty points.

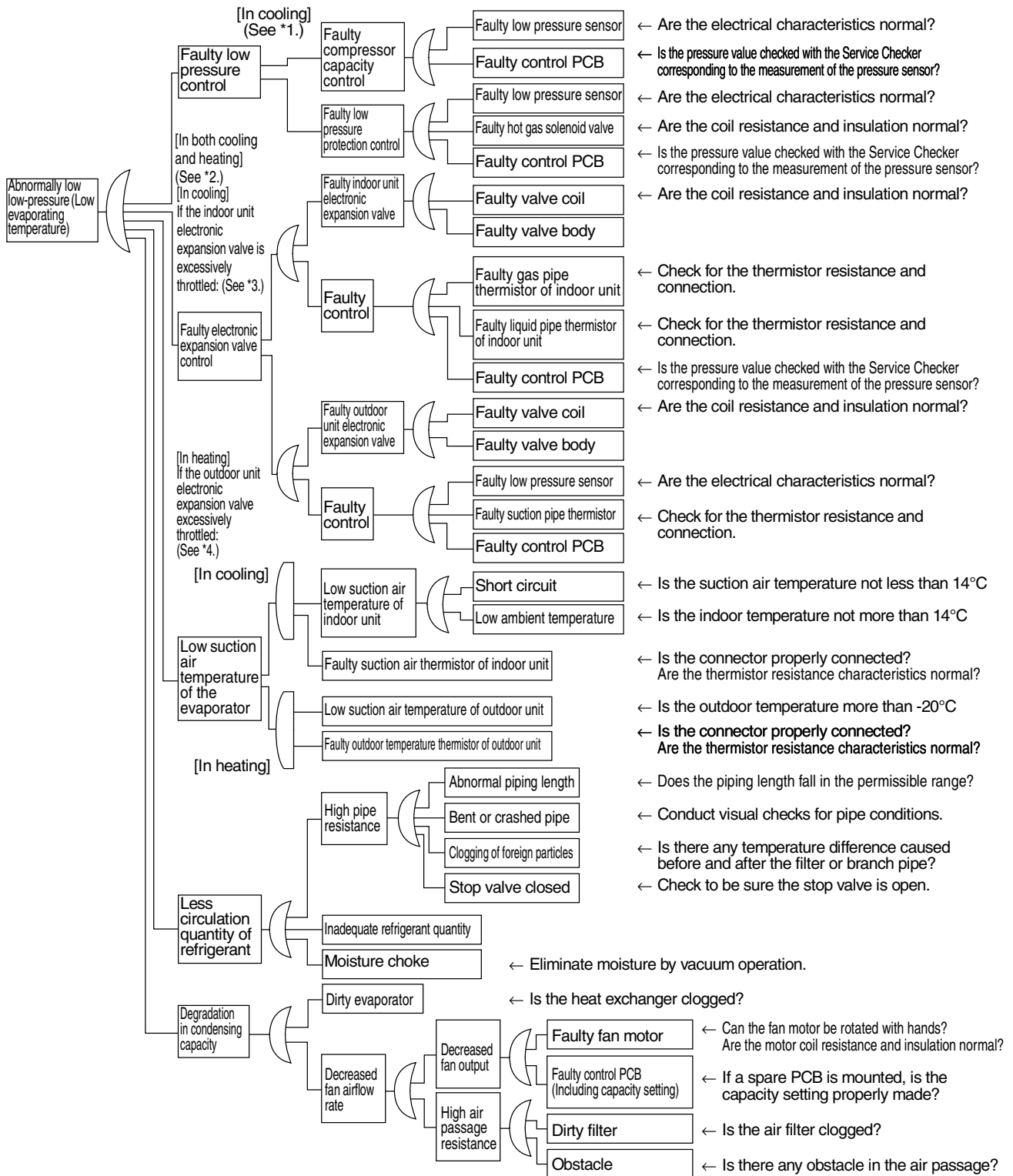

*1: For details of the compressor capacity control while in cooling, refer to "Compressor PI Control".
 *2: The "low pressure protection control" includes low pressure protection control and hot gas bypass control.
 *3: In cooling, the indoor unit electronic expansion valve is used for "superheated degree control".
 *4: In heating, the outdoor unit electronic expansion valve (EVM) is used for "superheated degree control of outdoor unit heat exchanger".

CHECK 3 Check the Factors of Overheat Operation

Identify the defective points referring to the failure factor analysis (FTA) as follows.

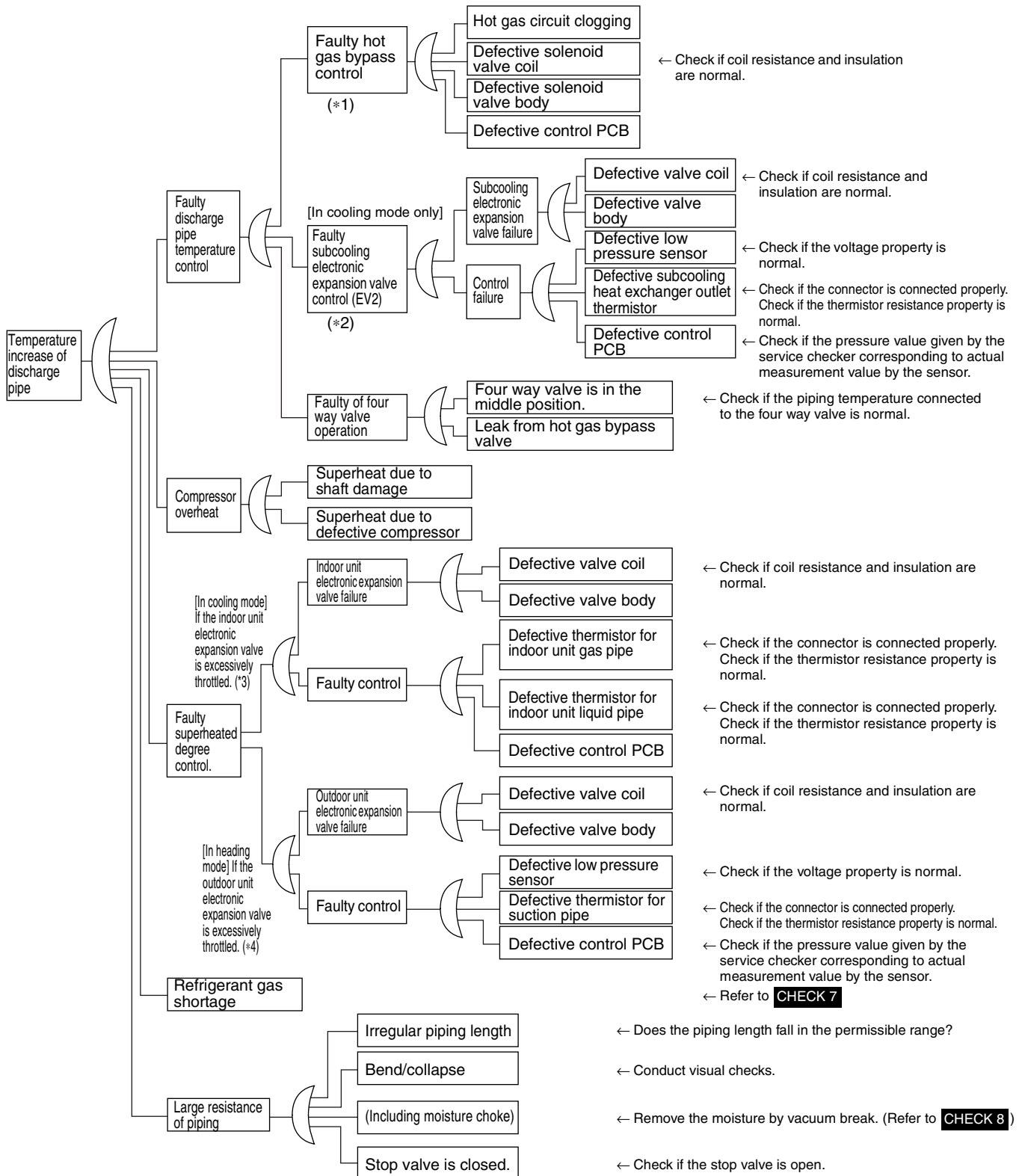

- *1: Refer to “Low pressure protection control” for hot gas bypass control.
- *2: Refer to “Subcooling electronic expansion valve control”.
- *3: “Superheating temperature control” in cooling mode is conducted by indoor unit electronic expansion valve.
- *4: Superheating temperature control in heating mode is conducted by outdoor unit electronic expansion valve (EVM).
- *5: Judgement criteria of superheat operation:
 (1) Suction gas superheating temperature: 10 degrees and over. (2) Discharge gas superheating temperature: 45 degrees and over, except for immediately after starting and drooping control, etc..
 (Use the above stated values as a guide. Depending on the other conditions, the unit may be normal despite the values within the above scope.)

CHECK 4 Power Transistor Check

Perform the following procedures prior to check.

- (1) Power Off.
- (2) Remove all the wiring connected to the PCB where power transistors are mounted on.

[Preparation]

- Tester

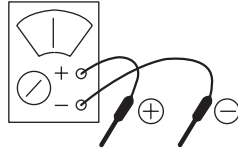

* Preparing a tester in the analog system is recommended. A tester in the digital system with diode check function will be usable.

[Point of Measurement and Judgement Criteria]

- Measure the resistance value using a tester at each point of measurement below, 10 minutes later after power OFF.

To use analog tester:
Measurement in the resistance value mode in the range of multiplying 1kΩ.

| No. | Point of Measurement | | Judgement Criteria | Remarks |
|-----|----------------------|----|------------------------------|--|
| | + | - | | |
| 1 | P2 | U | 2 ~ 15kΩ | Due to condenser charge and so on, resistance measurement may require some time. |
| 2 | P2 | V | | |
| 3 | P2 | W | | |
| 4 | U | P2 | 15kΩ and above (including ∞) | |
| 5 | V | P2 | | |
| 6 | W | P2 | | |
| 7 | N3 | U | 2 ~ 15kΩ | |
| 8 | N3 | V | | |
| 9 | N3 | W | | |
| 10 | U | N3 | 2 ~ 15kΩ | |
| 11 | V | N3 | | |
| 12 | W | N3 | | |

To use digital tester:
Measurement is executed in the diode check mode. (→|←)

| No. | Point of Measurement | | Judgement Criteria | Remarks |
|-----|----------------------|----|--------------------|--|
| | + | - | | |
| 1 | P2 | U | 1.2V and over | Due to condenser charge and so on, resistance measurement may require some time. |
| 2 | P2 | V | | |
| 3 | P2 | W | | |
| 4 | U | P2 | 0.3 ~ 0.7V | |
| 5 | V | P2 | | |
| 6 | W | P2 | | |
| 7 | N3 | U | 1.2V and over | |
| 8 | N3 | V | | |
| 9 | N3 | W | | |
| 10 | U | N3 | 1.2V and over | |
| 11 | V | N3 | | |
| 12 | W | N3 | | |

[PCB and Circuit Diagram]

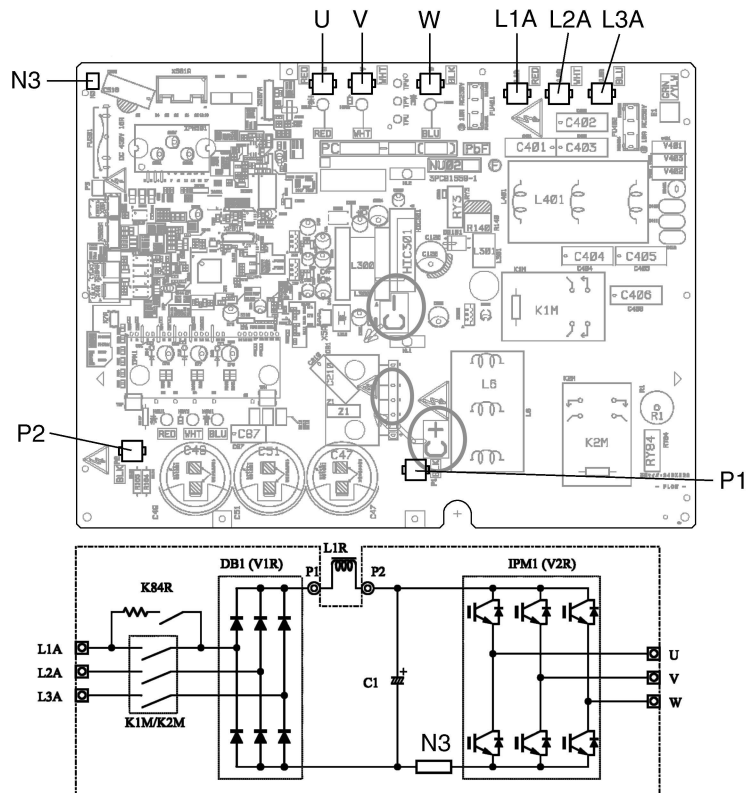

CHECK 5 Check for causes of wet operation.

Referring to the Fault Tree Analysis (FTA) shown below, identify faulty points.

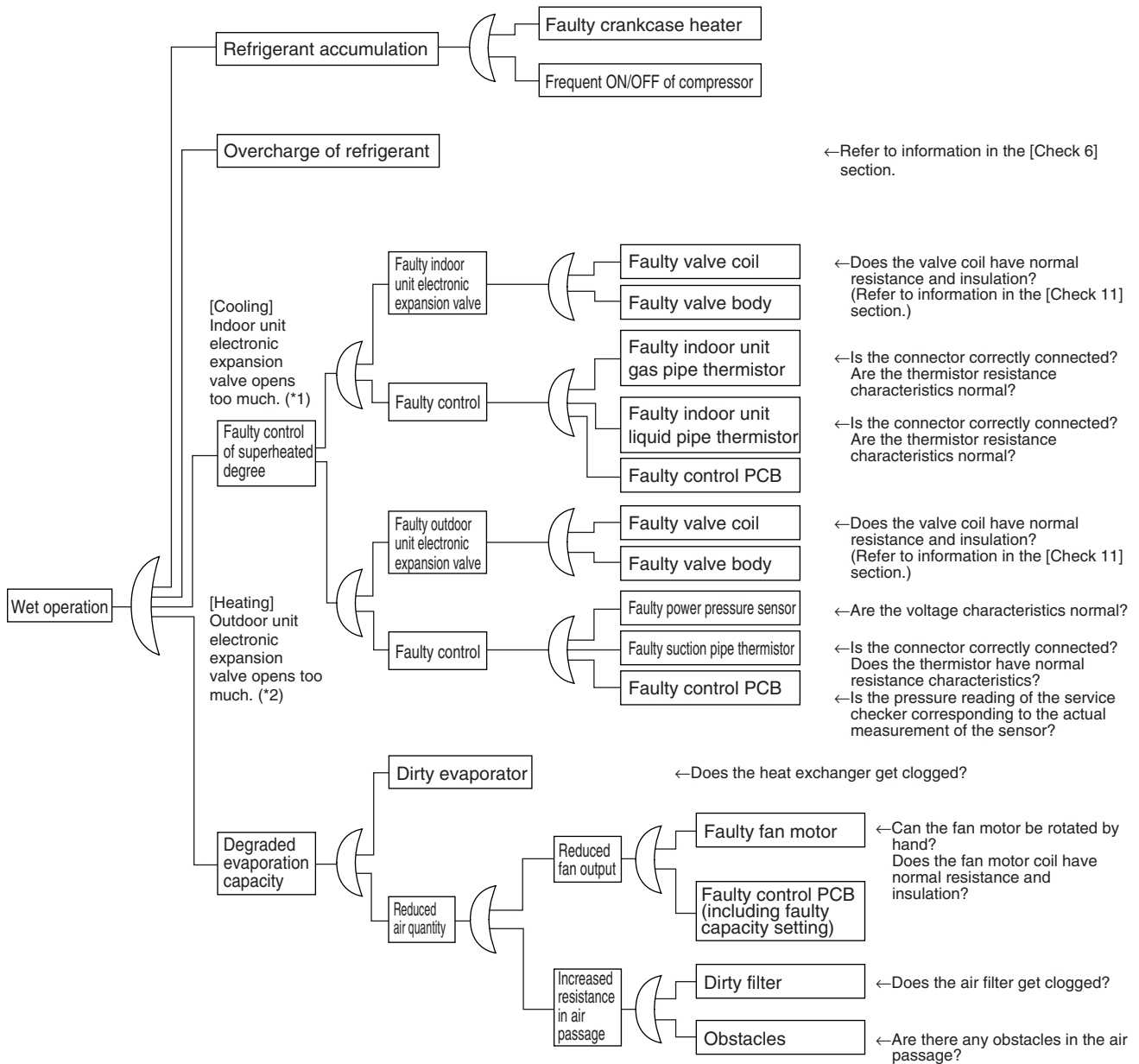

*1: "Superheated degree control" in cooling operation is exercised with the indoor unit electronic expansion valve.
 *2: "Superheated degree control" in heating operation is exercised with the outdoor unit electronic expansion valve (EV1).
 *3: Guideline of superheated degree to judge as wet operation
 ① Suction gas superheated degree: Not more than 3°C; ② Discharge gas superheated degree: Not more than 15°C, except immediately after compressor starts up or is running under drooping control.
 (Use the values shown above as a guideline. Even if the superheated degree falls in the range, the compressor may be normal depending on other conditions.)

CHECK 6 Check for overcharge of refrigerant.

In case of VRV Systems, the only way to judge as the overcharge of refrigerant is with operating conditions due to the relationship to pressure control and electronic expansion valve control. As information for making a judgement, refer to information provided below.

Diagnosis of overcharge of refrigerant

1. High pressure rises. Consequently, overload control is exercised to cause scant cooling capacity.
2. The superheated degree of suction gas lowers (or the wet operation is performed). Consequently, the compressor becomes lower in discharge pipe temperature despite of pressure loads.
3. The supercooled degree of condensate rises. Consequently, in heating operation, the temperature of outlet air passing through the supercooled section becomes lower.

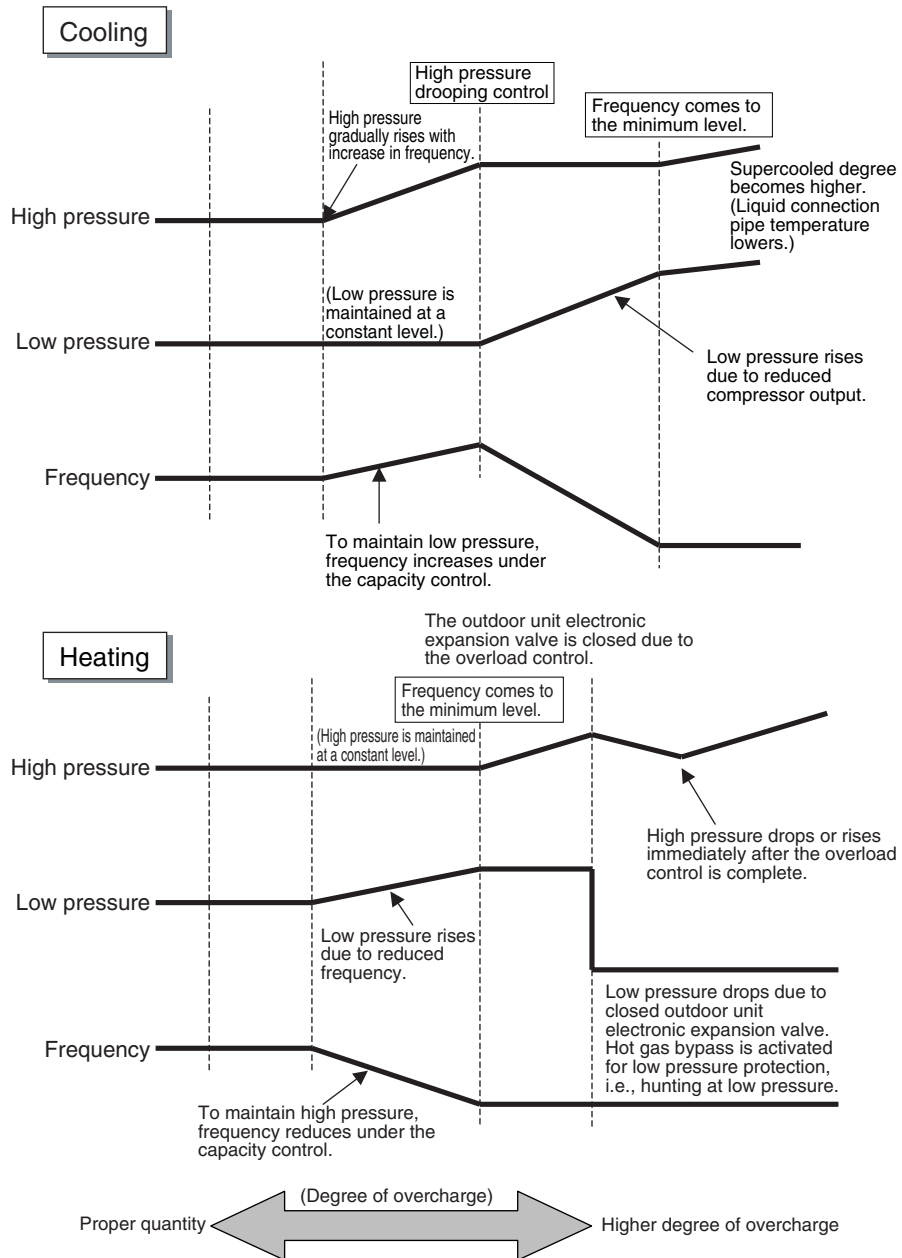

CHECK 7 Check for shortage of refrigerant.

In case of VRV Systems, the only way to judge as the shortage of refrigerant is with operating conditions due to the relationship to pressure control and electronic expansion valve control. As information for making a judgement, refer to information provided below.

Diagnosis of shortage of refrigerant

1. The superheated degree of suction gas rises. Consequently, the compressor discharge gas temperature becomes higher.
2. The superheated degree of suction gas rises. Consequently, the electronic expansion valve turns open.
3. Low pressure drops to cause the unit not to demonstrate cooling capacity (heating capacity).

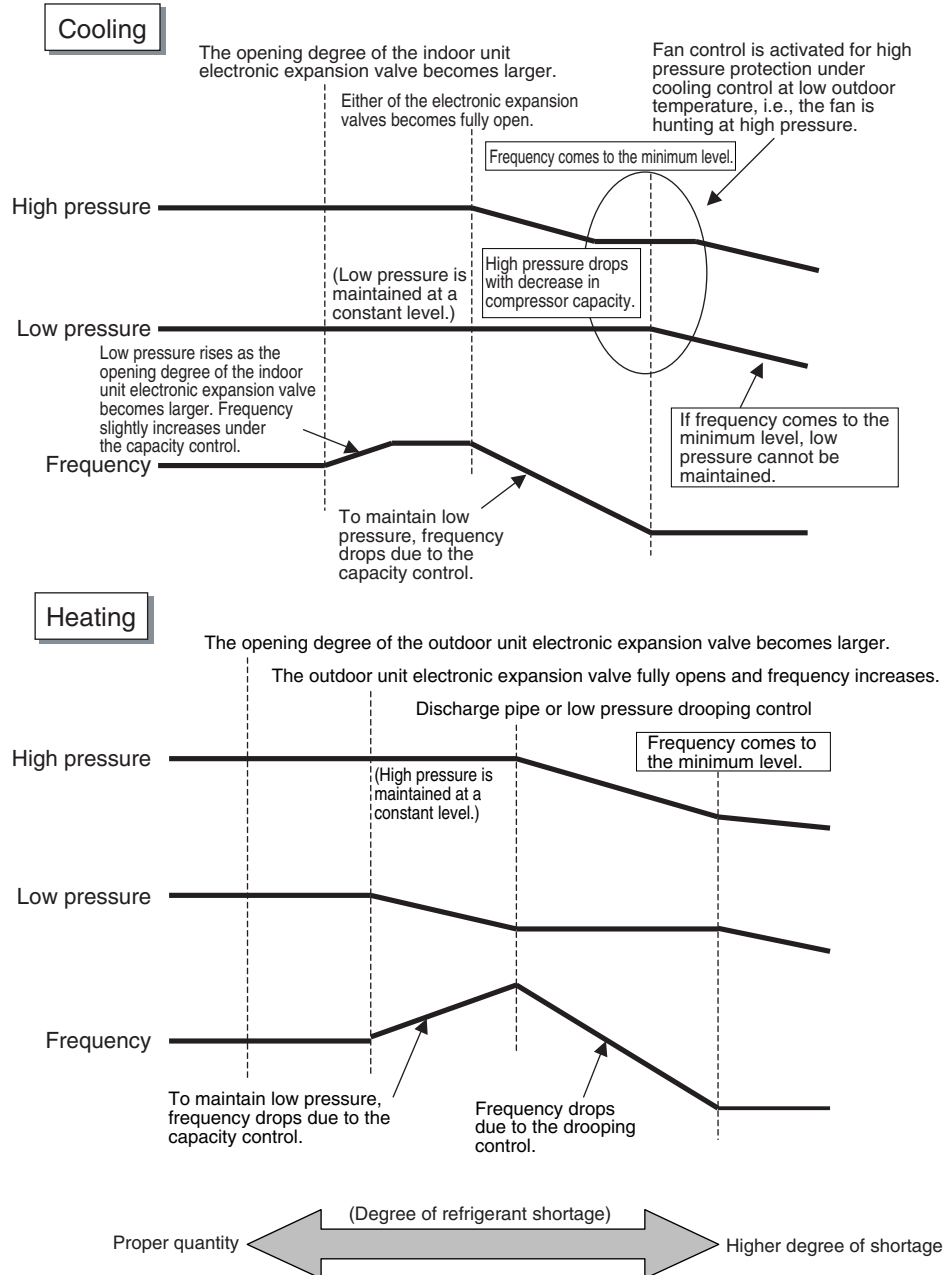

CHECK 8 **Vacuumping and dehydration procedure**

Conduct vacuumping and dehydration in the piping system following the procedure for <Normal vacuumping and dehydration> described below.

Furthermore, if moisture may get mixed in the piping system, follow the procedure for <Special vacuumping and dehydration> described below.

<Normal vacuumping and dehydration>

① Vacuumping and dehydration

- Use a vacuum pump that enables vacuumping up to 100.7kPa (5 torr, -755 mmHg).
- Connect manifold gauges to the service ports of liquid pipe and gas pipe and run the vacuum pump for a period of two or more hours to conduct evacuation to -100.7kPa or less.
- If the degree of vacuum does not reach -100.7kPa or less even though evacuation is conducted for a period of two hours, moisture will have entered the system or refrigerant leakage will have been caused. In this case, conduct evacuation for a period of another one hour.
- If the degree of vacuum does not reach -100.7kPa or less even though evacuation is conducted for a period of three hours, conduct leak tests.

② Leaving in vacuum state

- Leave the compressor at the degree of vacuum of -100.7kPa or less for a period of one hour or more, and then check to be sure that the vacuum gauge reading does not rise. (If the reading rises, moisture may have remained in the system or refrigerant leakage may have been caused.)

③ Refrigerant charge

- Purge air from the manifold gauge connection hoses, and then charge a necessary quantity of refrigerant.

<Special vacuumping and dehydration> - In case moisture may get mixed in the piping*

① Vacuumping and dehydration

- Follow the same procedure as that for 1) Normal vacuumping and dehydration described above.

② Vacuum break

- Pressurize with nitrogen gas up to 0.05MPa.

③ Vacuumping and dehydration

- Conduct vacuumping and dehydration for a period of one hour or more. If the degree of vacuum does not reach -100.7kPa or less even though evacuation is conducted for a period of two hours or more, repeat vacuum break - vacuumping and dehydration.

④ Leaving in vacuum state

- Leave the compressor at the degree of vacuum of -100.7kPa or less for a period of one hour or more, and then check to be sure that the vacuum gauge reading does not rise.

⑤ Refrigerant charge

- Purge air from the manifold gauge connection hoses, and then charge a necessary quantity of refrigerant.

- * In case of construction during rainy reason, if dew condensation occurs in the piping due to extended construction period, or rainwater or else may enter the piping during construction work:

CHECK 9 List of inverter-related malfunction codes

| | Code | Name | Condition for determining malfunction | Major cause |
|------------------------------|------|---|---|---|
| Compressor current | L5 | Instantaneous overcurrent of inverter compressor | <ul style="list-style-type: none"> Inverter output current exceeds 32.3A even instantaneously. | <ul style="list-style-type: none"> Liquid sealing Faulty compressor Faulty inverter PCB |
| | L8 | Overcurrent of inverter compressor (Electronic thermal) | <ul style="list-style-type: none"> Compressor overload running An overcurrent of 19.0A or more continues for a period of 5 consecutive seconds or that of 16.1A or more continues for a period of 260 consecutive seconds. The inverter loses synchronization. | <ul style="list-style-type: none"> Backflow of compressor liquid Sudden changes in loads Disconnected compressor wiring Faulty inverter PCB |
| Protection device and others | L1 | Faulty inverter PCB | <ul style="list-style-type: none"> No output is given. | <ul style="list-style-type: none"> Faulty heavy current part of compressor |
| | L9 | Faulty startup of inverter compressor | <ul style="list-style-type: none"> The compressor motor fails to start up. | <ul style="list-style-type: none"> Liquid sealing or faulty compressor Excessive oil or refrigerant Faulty inverter PCB |
| | E5 | Inverter compressor lock | <ul style="list-style-type: none"> The compressor is in the locked status (does not rotate). | <ul style="list-style-type: none"> Faulty compressor |
| | L4 | Radiator fin temperature rise | <ul style="list-style-type: none"> The radiator fin temperature reaches 87°C or more (while in operation). | <ul style="list-style-type: none"> Malfunction of fan Running in overload for an extended period of time Faulty inverter PCB |
| | U2 | Power supply voltage error | <ul style="list-style-type: none"> The inverter power supply voltage is high or low. | <ul style="list-style-type: none"> Power supply error Faulty inverter PCB |
| | P1 | Imbalanced power supply | <ul style="list-style-type: none"> Power supply voltages get significantly imbalanced among three phases. | <ul style="list-style-type: none"> Power supply error (imbalanced voltages of 2% or more) Faulty inverter PCB Dead inverter PCB |
| | LC | Transmission error (between inverter PCB and control PCB) | <ul style="list-style-type: none"> With the outdoor unit PCB, no communications are carried out across control PCB - inverter PCB - fan PCB. | <ul style="list-style-type: none"> Broken wire in communication line Faulty control PCB Faulty inverter PCB Faulty fan PCB |
| | PJ | PCB mismatching | <ul style="list-style-type: none"> Any PCB of specification different from that of the product is connected. | <ul style="list-style-type: none"> PCB of different specification mounted |
| | P4 | Faulty fin thermistor | <ul style="list-style-type: none"> The fin thermistor gets short-circuited or open. | <ul style="list-style-type: none"> Faulty fin thermistor |

CHECK 10 Concept of inverter-related malfunction codes

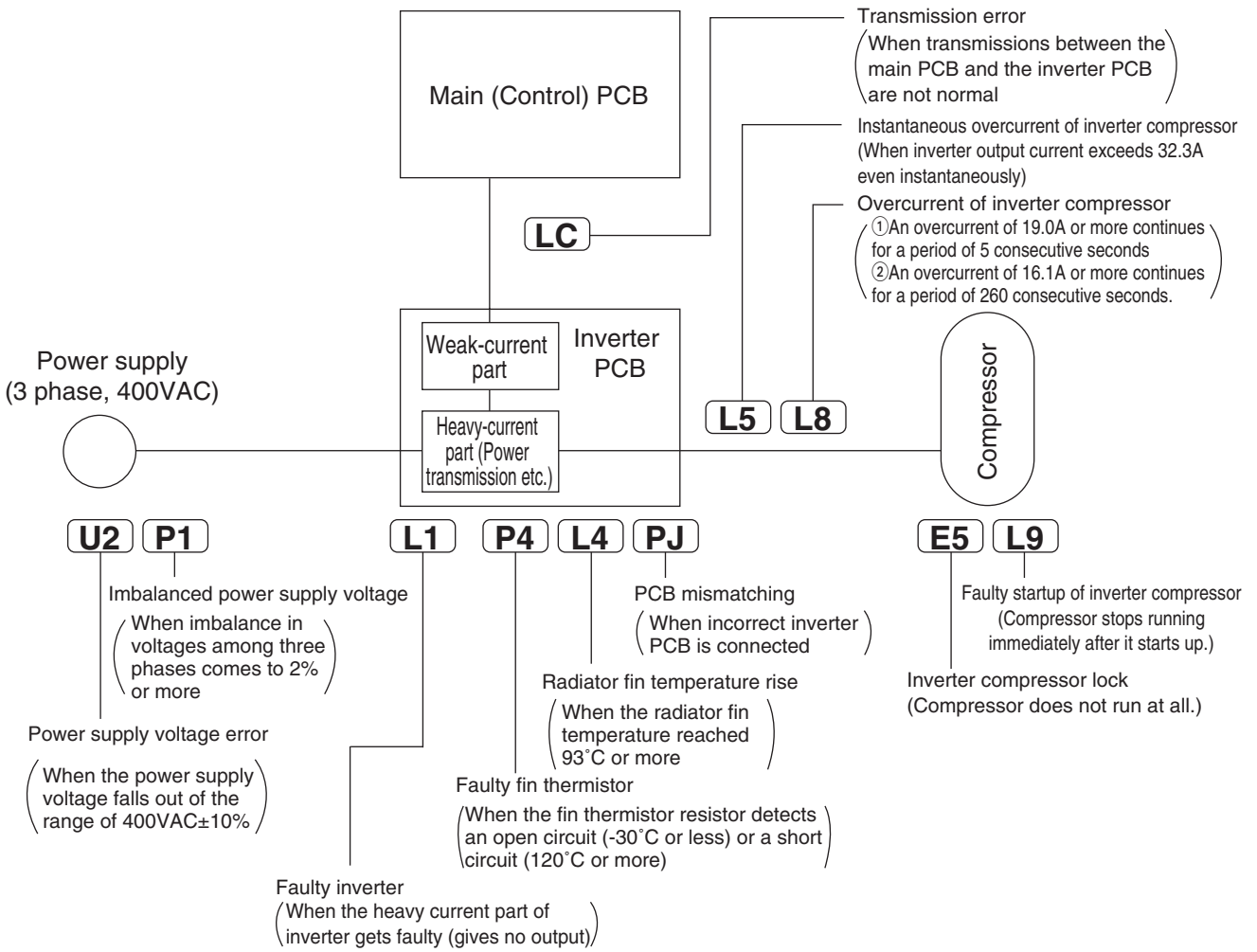

Malfunction codes related to compressor current

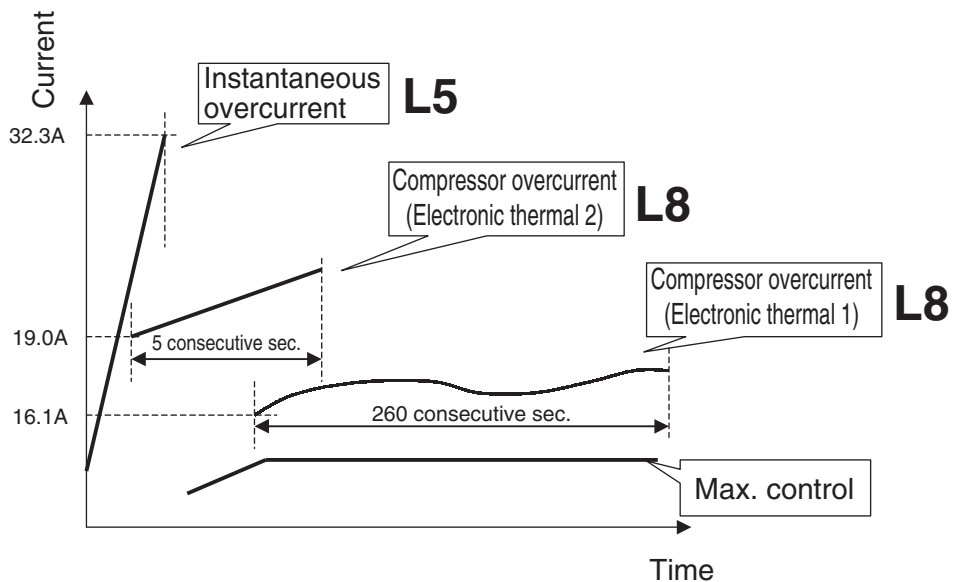

CHECK 11 Thermistor Resistance / Temperature Characteristics

Indoor unit For air suction R1T
 For liquid pipe R2T
 For gas pipe R3T

Outdoor unit for fin thermistor R1T

Outdoor unit For outdoor air R1T
 For coil R2T
 For suction pipe R4T
 For Receiver gas pipe R5T
 For Receiver outlet liquid pipe R6T

| T°C | kΩ |
|-----|------|
| -10 | - |
| -8 | - |
| -6 | 88.0 |
| -4 | 79.1 |
| -2 | 71.1 |
| 0 | 64.1 |
| 2 | 57.8 |
| 4 | 52.3 |
| 6 | 47.3 |
| 8 | 42.9 |
| 10 | 38.9 |
| 12 | 35.3 |
| 14 | 32.1 |
| 16 | 29.2 |
| 18 | 26.6 |
| 20 | 24.3 |
| 22 | 22.2 |
| 24 | 20.3 |
| 26 | 18.5 |
| 28 | 17.0 |
| 30 | 15.6 |
| 32 | 14.2 |
| 34 | 13.1 |
| 36 | 12.0 |
| 38 | 11.1 |
| 40 | 10.3 |
| 42 | 9.5 |
| 44 | 8.8 |
| 46 | 8.2 |
| 48 | 7.6 |
| 50 | 7.0 |
| 52 | 6.7 |
| 54 | 6.0 |
| 56 | 5.5 |
| 58 | 5.2 |
| 60 | 4.79 |
| 62 | 4.46 |
| 64 | 4.15 |
| 66 | 3.87 |
| 68 | 3.61 |
| 70 | 3.37 |
| 72 | 3.15 |
| 74 | 2.94 |
| 76 | 2.75 |
| 78 | 2.51 |
| 80 | 2.41 |
| 82 | 2.26 |
| 84 | 2.12 |
| 86 | 1.99 |
| 88 | 1.87 |
| 90 | 1.76 |
| 92 | 1.65 |
| 94 | 1.55 |
| 96 | 1.46 |
| 98 | 1.38 |

| T°C | kΩ |
|-----|--------|
| -20 | 197.81 |
| -19 | 186.53 |
| -18 | 175.97 |
| -17 | 166.07 |
| -16 | 156.80 |
| -15 | 148.10 |
| -14 | 139.94 |
| -13 | 132.28 |
| -12 | 125.09 |
| -11 | 118.34 |
| -10 | 111.99 |
| -9 | 106.03 |
| -8 | 100.41 |
| -7 | 95.14 |
| -6 | 90.17 |
| -5 | 85.49 |
| -4 | 81.08 |
| -3 | 76.93 |
| -2 | 73.01 |
| -1 | 69.32 |
| 0 | 65.84 |
| 1 | 62.54 |
| 2 | 59.43 |
| 3 | 56.49 |
| 4 | 53.71 |
| 5 | 51.09 |
| 6 | 48.61 |
| 7 | 46.26 |
| 8 | 44.05 |
| 9 | 41.95 |
| 10 | 39.96 |
| 11 | 38.08 |
| 12 | 36.30 |
| 13 | 34.62 |
| 14 | 33.02 |
| 15 | 31.50 |
| 16 | 30.06 |
| 17 | 28.70 |
| 18 | 27.41 |
| 19 | 26.18 |
| 20 | 25.01 |
| 21 | 23.91 |
| 22 | 22.85 |
| 23 | 21.85 |
| 24 | 20.90 |
| 25 | 20.00 |
| 26 | 19.14 |
| 27 | 18.32 |
| 28 | 17.54 |
| 29 | 16.80 |
| 30 | 16.10 |

| T°C | kΩ |
|-------|--------|
| -19.5 | 192.08 |
| -18.5 | 181.16 |
| -17.5 | 170.94 |
| -16.5 | 161.36 |
| -15.5 | 152.38 |
| -14.5 | 143.96 |
| -13.5 | 136.05 |
| -12.5 | 128.63 |
| -11.5 | 121.66 |
| -10.5 | 115.12 |
| -9.5 | 108.96 |
| -8.5 | 103.18 |
| -7.5 | 97.73 |
| -6.5 | 92.61 |
| -5.5 | 87.79 |
| -4.5 | 83.25 |
| -3.5 | 78.97 |
| -2.5 | 74.94 |
| -1.5 | 71.14 |
| -0.5 | 67.56 |
| 0.5 | 64.17 |
| 1.5 | 60.96 |
| 2.5 | 57.94 |
| 3.5 | 55.08 |
| 4.5 | 52.38 |
| 5.5 | 49.83 |
| 6.5 | 47.42 |
| 7.5 | 45.14 |
| 8.5 | 42.98 |
| 9.5 | 40.94 |
| 10.5 | 39.01 |
| 11.5 | 37.18 |
| 12.5 | 35.45 |
| 13.5 | 33.81 |
| 14.5 | 32.25 |
| 15.5 | 30.77 |
| 16.5 | 29.37 |
| 17.5 | 28.05 |
| 18.5 | 26.78 |
| 19.5 | 25.59 |
| 20.5 | 24.45 |
| 21.5 | 23.37 |
| 22.5 | 22.35 |
| 23.5 | 21.37 |
| 24.5 | 20.45 |
| 25.5 | 19.56 |
| 26.5 | 18.73 |
| 27.5 | 17.93 |
| 28.5 | 17.17 |
| 29.5 | 16.45 |
| 30.5 | 15.76 |

| T°C | kΩ |
|-----|-------|
| 30 | 16.10 |
| 31 | 15.43 |
| 32 | 14.79 |
| 33 | 14.18 |
| 34 | 13.59 |
| 35 | 13.04 |
| 36 | 12.51 |
| 37 | 12.01 |
| 38 | 11.52 |
| 39 | 11.06 |
| 40 | 10.63 |
| 41 | 10.21 |
| 42 | 9.81 |
| 43 | 9.42 |
| 44 | 9.06 |
| 45 | 8.71 |
| 46 | 8.37 |
| 47 | 8.05 |
| 48 | 7.75 |
| 49 | 7.46 |
| 50 | 7.18 |
| 51 | 6.91 |
| 52 | 6.65 |
| 53 | 6.41 |
| 54 | 6.18 |
| 55 | 5.95 |
| 56 | 5.73 |
| 57 | 5.52 |
| 58 | 5.31 |
| 59 | 5.11 |
| 60 | 4.91 |
| 61 | 4.71 |
| 62 | 4.52 |
| 63 | 4.33 |
| 64 | 4.14 |
| 65 | 3.95 |
| 66 | 3.76 |
| 67 | 3.57 |
| 68 | 3.38 |
| 69 | 3.19 |
| 70 | 3.00 |
| 71 | 2.81 |
| 72 | 2.62 |
| 73 | 2.43 |
| 74 | 2.24 |
| 75 | 2.05 |
| 76 | 1.86 |
| 77 | 1.67 |
| 78 | 1.48 |
| 79 | 1.29 |
| 80 | 1.10 |

| T°C | kΩ |
|------|-------|
| 30.5 | 15.76 |
| 31.5 | 15.10 |
| 32.5 | 14.48 |
| 33.5 | 13.88 |
| 34.5 | 13.31 |
| 35.5 | 12.77 |
| 36.5 | 12.25 |
| 37.5 | 11.76 |
| 38.5 | 11.29 |
| 39.5 | 10.84 |
| 40.5 | 10.41 |
| 41.5 | 10.00 |
| 42.5 | 9.61 |
| 43.5 | 9.24 |
| 44.5 | 8.88 |
| 45.5 | 8.54 |
| 46.5 | 8.21 |
| 47.5 | 7.90 |
| 48.5 | 7.60 |
| 49.5 | 7.31 |
| 50.5 | 7.04 |
| 51.5 | 6.78 |
| 52.5 | 6.53 |
| 53.5 | 6.29 |
| 54.5 | 6.05 |
| 55.5 | 5.81 |
| 56.5 | 5.57 |
| 57.5 | 5.33 |
| 58.5 | 5.10 |
| 59.5 | 4.87 |
| 60.5 | 4.64 |
| 61.5 | 4.41 |
| 62.5 | 4.18 |
| 63.5 | 3.95 |
| 64.5 | 3.72 |
| 65.5 | 3.49 |
| 66.5 | 3.26 |
| 67.5 | 3.03 |
| 68.5 | 2.80 |
| 69.5 | 2.57 |
| 70.5 | 2.34 |
| 71.5 | 2.11 |
| 72.5 | 1.88 |
| 73.5 | 1.65 |
| 74.5 | 1.42 |
| 75.5 | 1.19 |
| 76.5 | 0.96 |
| 77.5 | 0.73 |
| 78.5 | 0.50 |
| 79.5 | 0.27 |
| 80.5 | 0.04 |

**Outdoor Unit
Thermistors for
Discharge Pipe
(R3T, R31~33T)**

| | | | | | | | | | | | |
|-----|--------|------|--------|-----|-------|-------|-------|-----|-------|-------|-------|
| T°C | kΩ | T°C | kΩ | T°C | kΩ | T°C | kΩ | T°C | kΩ | T°C | kΩ |
| 0 | 640.44 | 0.5 | 624.65 | 50 | 72.32 | 50.5 | 70.96 | 100 | 13.35 | 100.5 | 13.15 |
| 1 | 609.31 | 1.5 | 594.43 | 51 | 69.64 | 51.5 | 68.34 | 101 | 12.95 | 101.5 | 12.76 |
| 2 | 579.96 | 2.5 | 565.78 | 52 | 67.06 | 52.5 | 65.82 | 102 | 12.57 | 102.5 | 12.38 |
| 3 | 552.00 | 3.5 | 538.63 | 53 | 64.60 | 53.5 | 63.41 | 103 | 12.20 | 103.5 | 12.01 |
| 4 | 525.63 | 4.5 | 512.97 | 54 | 62.24 | 54.5 | 61.09 | 104 | 11.84 | 104.5 | 11.66 |
| 5 | 500.66 | 5.5 | 488.67 | 55 | 59.97 | 55.5 | 58.87 | 105 | 11.49 | 105.5 | 11.32 |
| 6 | 477.01 | 6.5 | 465.65 | 56 | 57.80 | 56.5 | 56.75 | 106 | 11.15 | 106.5 | 10.99 |
| 7 | 454.60 | 7.5 | 443.84 | 57 | 55.72 | 57.5 | 54.70 | 107 | 10.83 | 107.5 | 10.67 |
| 8 | 433.37 | 8.5 | 423.17 | 58 | 53.72 | 58.5 | 52.84 | 108 | 10.52 | 108.5 | 10.36 |
| 9 | 413.24 | 9.5 | 403.57 | 59 | 51.98 | 59.5 | 50.96 | 109 | 10.21 | 109.5 | 10.06 |
| 10 | 394.16 | 10.5 | 384.98 | 60 | 49.96 | 60.5 | 49.06 | 110 | 9.92 | 110.5 | 9.78 |
| 11 | 376.05 | 11.5 | 367.35 | 61 | 48.19 | 61.5 | 47.33 | 111 | 9.64 | 111.5 | 9.50 |
| 12 | 358.88 | 12.5 | 350.62 | 62 | 46.49 | 62.5 | 45.67 | 112 | 9.36 | 112.5 | 9.23 |
| 13 | 342.58 | 13.5 | 334.74 | 63 | 44.86 | 63.5 | 44.07 | 113 | 9.10 | 113.5 | 8.97 |
| 14 | 327.10 | 14.5 | 319.66 | 64 | 43.30 | 64.5 | 42.54 | 114 | 8.84 | 114.5 | 8.71 |
| 15 | 312.41 | 15.5 | 305.33 | 65 | 41.79 | 65.5 | 41.06 | 115 | 8.59 | 115.5 | 8.47 |
| 16 | 298.45 | 16.5 | 291.73 | 66 | 40.35 | 66.5 | 39.65 | 116 | 8.35 | 116.5 | 8.23 |
| 17 | 285.18 | 17.5 | 278.80 | 67 | 38.96 | 67.5 | 38.29 | 117 | 8.12 | 117.5 | 8.01 |
| 18 | 272.58 | 18.5 | 266.51 | 68 | 37.63 | 68.5 | 36.98 | 118 | 7.89 | 118.5 | 7.78 |
| 19 | 260.60 | 19.5 | 254.72 | 69 | 36.34 | 69.5 | 35.72 | 119 | 7.68 | 119.5 | 7.57 |
| 20 | 249.00 | 20.5 | 243.61 | 70 | 35.11 | 70.5 | 34.51 | 120 | 7.47 | 120.5 | 7.36 |
| 21 | 238.36 | 21.5 | 233.14 | 71 | 33.92 | 71.5 | 33.35 | 121 | 7.26 | 121.5 | 7.16 |
| 22 | 228.05 | 22.5 | 223.08 | 72 | 32.78 | 72.5 | 32.23 | 122 | 7.06 | 122.5 | 6.97 |
| 23 | 218.24 | 23.5 | 213.51 | 73 | 31.69 | 73.5 | 31.15 | 123 | 6.87 | 123.5 | 6.78 |
| 24 | 208.90 | 24.5 | 204.39 | 74 | 30.63 | 74.5 | 30.12 | 124 | 6.69 | 124.5 | 6.59 |
| 25 | 200.00 | 25.5 | 195.71 | 75 | 29.61 | 75.5 | 29.12 | 125 | 6.51 | 125.5 | 6.42 |
| 26 | 191.53 | 26.5 | 187.44 | 76 | 28.64 | 76.5 | 28.16 | 126 | 6.33 | 126.5 | 6.25 |
| 27 | 183.46 | 27.5 | 179.57 | 77 | 27.69 | 77.5 | 27.24 | 127 | 6.16 | 127.5 | 6.08 |
| 28 | 175.77 | 28.5 | 172.06 | 78 | 26.79 | 78.5 | 26.35 | 128 | 6.00 | 128.5 | 5.92 |
| 29 | 168.44 | 29.5 | 164.90 | 79 | 25.91 | 79.5 | 25.49 | 129 | 5.84 | 129.5 | 5.76 |
| 30 | 161.45 | 30.5 | 158.08 | 80 | 25.07 | 80.5 | 24.66 | 130 | 5.69 | 130.5 | 5.61 |
| 31 | 154.79 | 31.5 | 151.57 | 81 | 24.26 | 81.5 | 23.87 | 131 | 5.54 | 131.5 | 5.46 |
| 32 | 148.43 | 32.5 | 145.37 | 82 | 23.48 | 82.5 | 23.10 | 132 | 5.39 | 132.5 | 5.32 |
| 33 | 142.37 | 33.5 | 139.44 | 83 | 22.73 | 83.5 | 22.36 | 133 | 5.25 | 133.5 | 5.18 |
| 34 | 136.59 | 34.5 | 133.79 | 84 | 22.01 | 84.5 | 21.65 | 134 | 5.12 | 134.5 | 5.05 |
| 35 | 131.06 | 35.5 | 128.39 | 85 | 21.31 | 85.5 | 20.97 | 135 | 4.98 | 135.5 | 4.92 |
| 36 | 125.79 | 36.5 | 123.24 | 86 | 20.63 | 86.5 | 20.31 | 136 | 4.86 | 136.5 | 4.79 |
| 37 | 120.76 | 37.5 | 118.32 | 87 | 19.98 | 87.5 | 19.67 | 137 | 4.73 | 137.5 | 4.67 |
| 38 | 115.95 | 38.5 | 113.62 | 88 | 19.36 | 88.5 | 19.05 | 138 | 4.61 | 138.5 | 4.55 |
| 39 | 111.35 | 39.5 | 109.13 | 89 | 18.75 | 89.5 | 18.46 | 139 | 4.49 | 139.5 | 4.44 |
| 40 | 106.96 | 40.5 | 104.84 | 90 | 18.17 | 90.5 | 17.89 | 140 | 4.38 | 140.5 | 4.32 |
| 41 | 102.76 | 41.5 | 100.73 | 91 | 17.61 | 91.5 | 17.34 | 141 | 4.27 | 141.5 | 4.22 |
| 42 | 98.75 | 42.5 | 96.81 | 92 | 17.07 | 92.5 | 16.80 | 142 | 4.16 | 142.5 | 4.11 |
| 43 | 94.92 | 43.5 | 93.06 | 93 | 16.54 | 93.5 | 16.29 | 143 | 4.06 | 143.5 | 4.01 |
| 44 | 91.25 | 44.5 | 89.47 | 94 | 16.04 | 94.5 | 15.79 | 144 | 3.96 | 144.5 | 3.91 |
| 45 | 87.74 | 45.5 | 86.04 | 95 | 15.55 | 95.5 | 15.31 | 145 | 3.86 | 145.5 | 3.81 |
| 46 | 84.38 | 46.5 | 82.75 | 96 | 15.08 | 96.5 | 14.85 | 146 | 3.76 | 146.5 | 3.72 |
| 47 | 81.16 | 47.5 | 79.61 | 97 | 14.62 | 97.5 | 14.40 | 147 | 3.67 | 147.5 | 3.62 |
| 48 | 78.09 | 48.5 | 76.60 | 98 | 14.18 | 98.5 | 13.97 | 148 | 3.58 | 148.5 | 3.54 |
| 49 | 75.14 | 49.5 | 73.71 | 99 | 13.76 | 99.5 | 13.55 | 149 | 3.49 | 149.5 | 3.45 |
| 50 | 72.32 | 50.5 | 70.96 | 100 | 13.35 | 100.5 | 13.15 | 150 | 3.41 | 150.5 | 3.37 |

CHECK 12 Pressure Sensor

$$P_H = 1.38V_H - 0.69$$

V_H : Output Voltage [High Side] V_{DC}

$$P_L = 0.57V_L - 0.28$$

V_L : Output Voltage [Low Side] V_{DC}

P_H : High pressure (MPa)

P_L : Low pressure (MPa)

Detected Pressure

P_H, P_L
(kg/cm^2) MPa

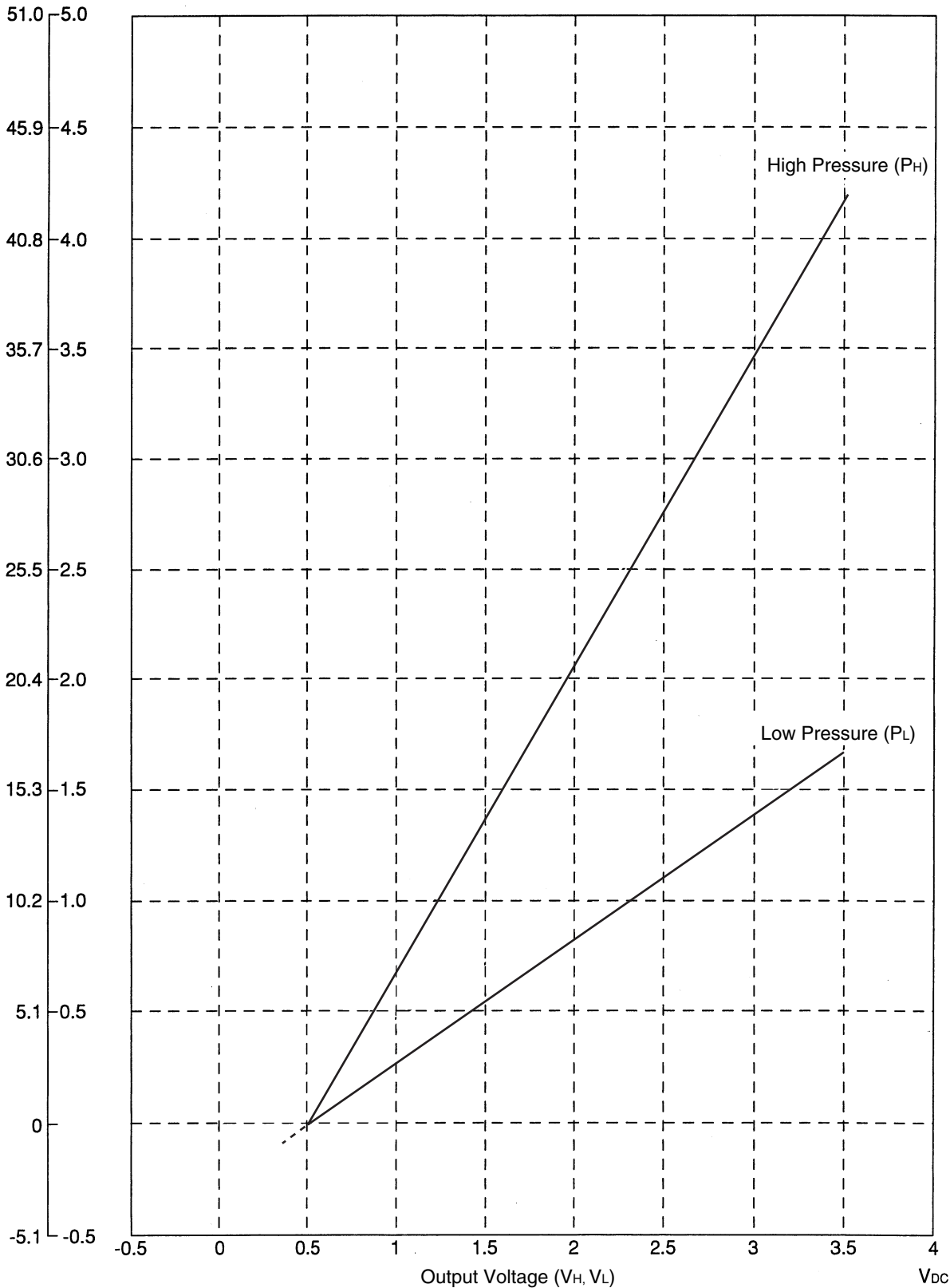

(V3053)

CHECK 13 Broken Wire Check of the Connecting Wires

1. Procedure for checking outdoor-outdoor unit transmission wiring for broken wires
 On the system shown below, turn OFF the power supply to all equipment, short-circuit between the outdoor-outdoor unit terminal parts F1 and F2 in the "Outdoor Unit A" that is farthest from the centralized remote controller, and then conduct continuity checks between the transmission wiring terminal blocks F1 and F2 of the centralized remote controller using a multiple meter. If there is continuity between the said terminal blocks, the outdoor-outdoor unit transmission wiring has no broken wires in it.
 If there is no continuity, the transmission wiring may have broken wires. With the outdoor-outdoor unit terminal parts of the "Outdoor Unit A" short-circuited, conduct continuity checks between the transmission wiring terminal blocks F1 and F2 of the unified ON/OFF controller. If there is no continuity as well, conduct continuity checks between the outdoor-outdoor unit terminal parts of the "Outdoor Unit E", between the outdoor-outdoor unit terminal parts of the "Outdoor Unit D", between the outdoor-outdoor unit terminal parts of the "Outdoor Unit C", ... in the order described, thus identifying the place with continuity.
 If the place with continuity can be identified, there may be broken wires in places before the said place with continuity.

2. Procedure for checking indoor-outdoor unit transmission wiring for broken wires (for checking the indoor-outdoor unit transmission wiring of the "Outdoor Unit C" for broken wires)
 Turn OFF the power supply to all equipment, short-circuit between the indoor-outdoor unit terminal parts F1 and F2 in the "Outdoor Unit C, and then conduct continuity checks between the transmission wirings F1 and F2 of the "Indoor Unit a" that is farthest from the "Outdoor Unit C" using a multiple meter. If there is continuity between the said transmission wirings, the indoor-outdoor unit transmission wiring has no broken wires in it.
 If there is no continuity, the transmission wiring may have broken wires. With the indoor-outdoor unit terminal parts of the "Outdoor Unit C" short-circuited, identify the place with continuity in the transmission wiring of the "Indoor Unit b", transmission wiring of the "Indoor Unit c", and transmission wiring of the "Indoor Unit d" in the order described.
 If the place with continuity can be identified, there may be broken wires in places before the said place with continuity.

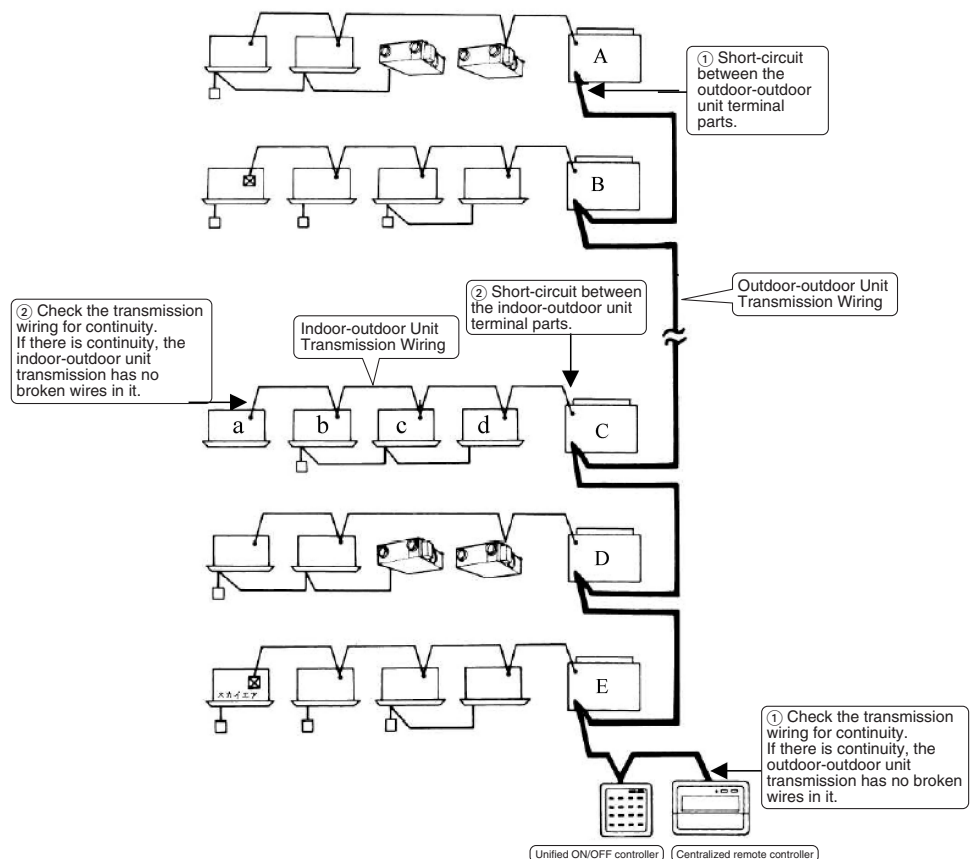

CHECK 14 Master Unit Central Connector Setting Table

The master unit central setting connector (CN1/X1A) is mounted at the factory.

- To independently use a single unit of the intelligent Touch Controller or a single unit of the centralized remote controller, do not dismount the master unit central setting connector (i.e., use the connector with the factory setting unchanged).
- To independently use the schedule timer, insert an independent-use setting connector. No independent-use setting connector has been mounted at the factory. Insert the connector, which is attached to the casing of the main unit, in the PCB (CN1/X1A). (Independent-use connector=Master unit central setting connector)
- To use two or more central equipment in combination, make settings according to the table shown below.

| Pattern | Central equipment connection pattern | | | | Setting of master unit central setting connector(*2) | | | | | |
|---------|--------------------------------------|-------------------------------|---------------------------|----------------|--|-------------------------------|--|----------------|--------------|--------------|
| | intelligent Touch Controller | Centralized remote controller | Unified ON/OFF controller | Schedule timer | intelligent Touch Controller | Centralized remote controller | Unified ON/OFF controller | Schedule timer | | |
| ① | 1 to 2 units | / | / | × (*1) | Only a single unit: "Provided", Others: "Not provided" | / | / | / | | |
| ② | 1 unit | 1 unit | / | × (*1) | Provided | Not provided | / | / | | |
| ③ | | | | × (*1) | | | | | | |
| ④ | 1 to 2 units | / | 1 to 8 units | × (*1) | Only a single unit: "Provided", Others: "Not provided" | / | All "Not provided" | / | | |
| ⑤ | / | 1 to 4 units | / | / | Only a single unit: "Provided", Others: "Not provided" | / | All "Not provided" | / | | |
| ⑥ | / | | | 1 to 16 units | | | | 1 unit | / | Not provided |
| ⑦ | / | | | / | | | | 1 unit | / | Not provided |
| ⑧ | / | | | / | | | | 1 unit | / | Not provided |
| ⑨ | / | / | 1 to 16 units | / | / | / | Only a single unit: "Provided", Others: "Not provided" | / | | |
| ⑩ | / | / | | 1 unit | | | | / | Not provided | |
| ⑪ | / | / | / | 1 unit | / | / | / | Provided | | |

(*1) The intelligent Touch Controller and the schedule timer are not available for combined use.

(*2) The intelligent Touch Controller, central remote controller, and the unified ON/OFF controller have been set to "Provided with the master unit central setting connector" at the factory. The schedule timer has been set to "Not provided with the master unit central setting connector" at the factory, which is attached to the casing of the main unit.

CHECK 15 Master-Slave Unit Setting Table

Combination of intelligent Touch Controller and Centralized Remote Controller



| * | #1 | | #2 | | #3 | | #4 | |
|---------|------------------------------|--------------|-----------|--------------|------------------------------|--------------|-----------|--------------|
| Pattern | 1-00~4-15 | Master/Slave | 5-00~8-15 | Master/Slave | 1-00~4-15 | Master/Slave | 5-00~8-15 | Master/Slave |
| ① | CRC | Master | CRC | Master | CRC | Slave | CRC | Slave |
| ② | CRC | Master | — | — | CRC | Slave | — | — |
| ③ | intelligent Touch Controller | Master | — | — | intelligent Touch Controller | Slave | — | — |
| ④ | CRC | Master | — | — | intelligent Touch Controller | Slave | — | — |
| ⑤ | intelligent Touch Controller | Master | — | — | CRC | Slave | — | — |
| ⑥ | CRC | Master | — | — | — | — | — | — |
| ⑦ | intelligent Touch Controller | Master | — | — | — | — | — | — |

CRC: Centralized remote controller <DCS302CA61>

intelligent Touch Controller: <(DCS601C51)>

The patterns marked with "" have nothing to do with those described in the list of Setting of master unit central setting connector.

Part 7

Appendix

| | |
|---|-----|
| 1. Piping Diagrams..... | 206 |
| 1.1 Outdoor Unit..... | 206 |
| 1.2 BS Unit..... | 207 |
| 2. Wiring Diagrams for Reference..... | 210 |
| 2.1 Outdoor Unit..... | 210 |
| 2.2 BS Unit..... | 211 |
| 3. Option List..... | 214 |
| 3.1 Option Lists (Outdoor Unit)..... | 214 |
| 4. Example of connection (R-410A Type)..... | 216 |

1.2 BS Unit

BSVQ100, 160, 250PV1

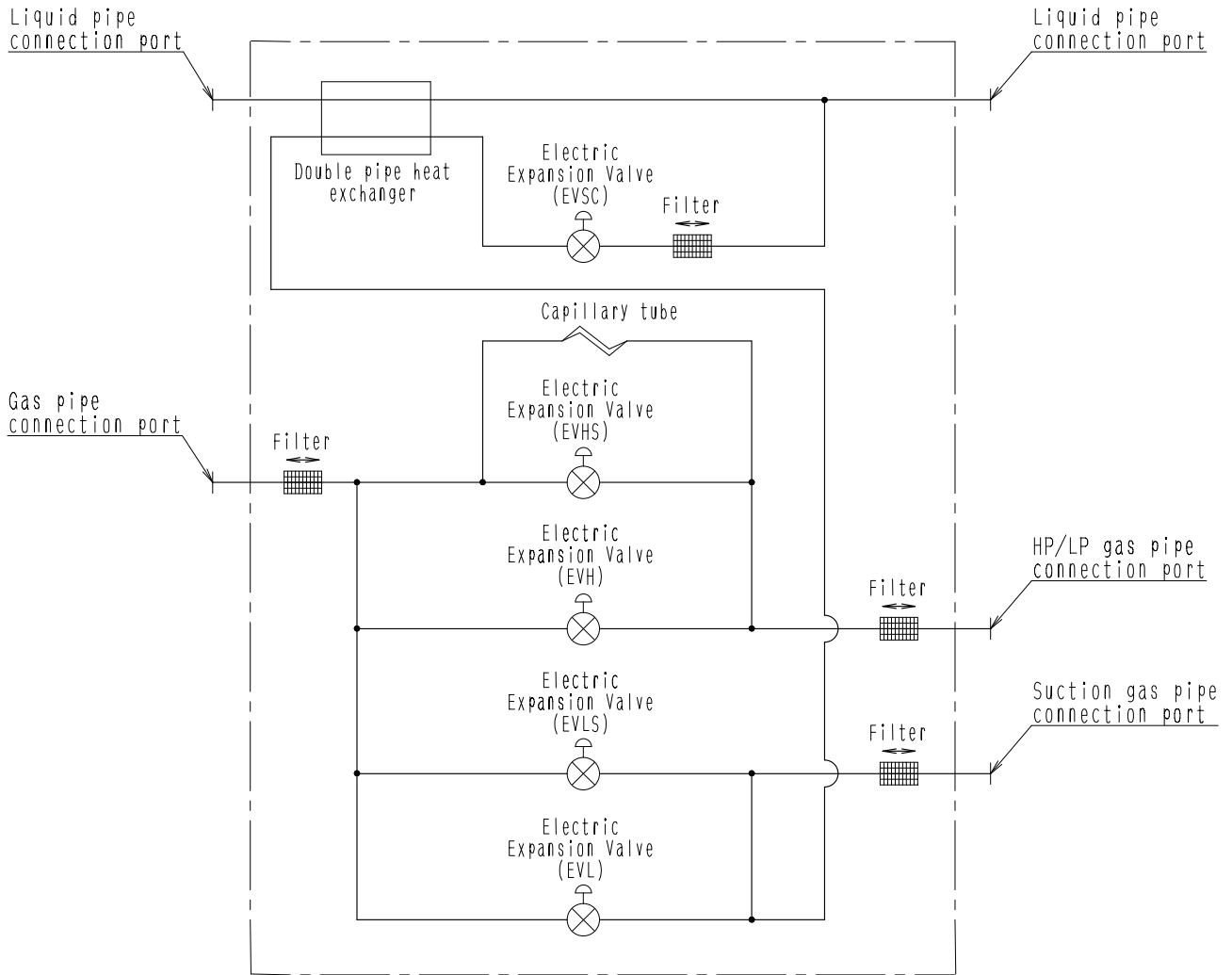

4D057985B

BSV4Q100PV1

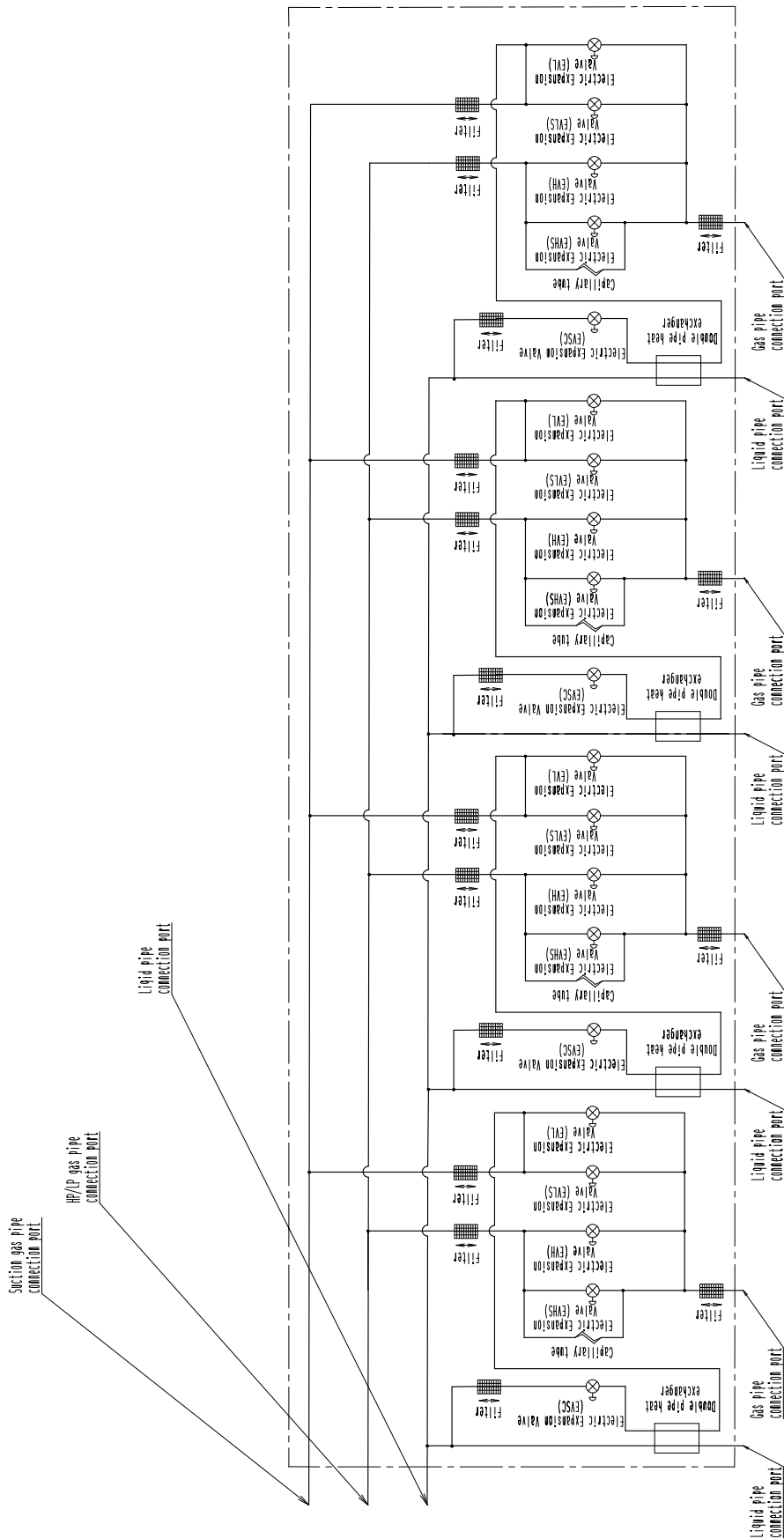

3D064148

BSV6Q100PV1

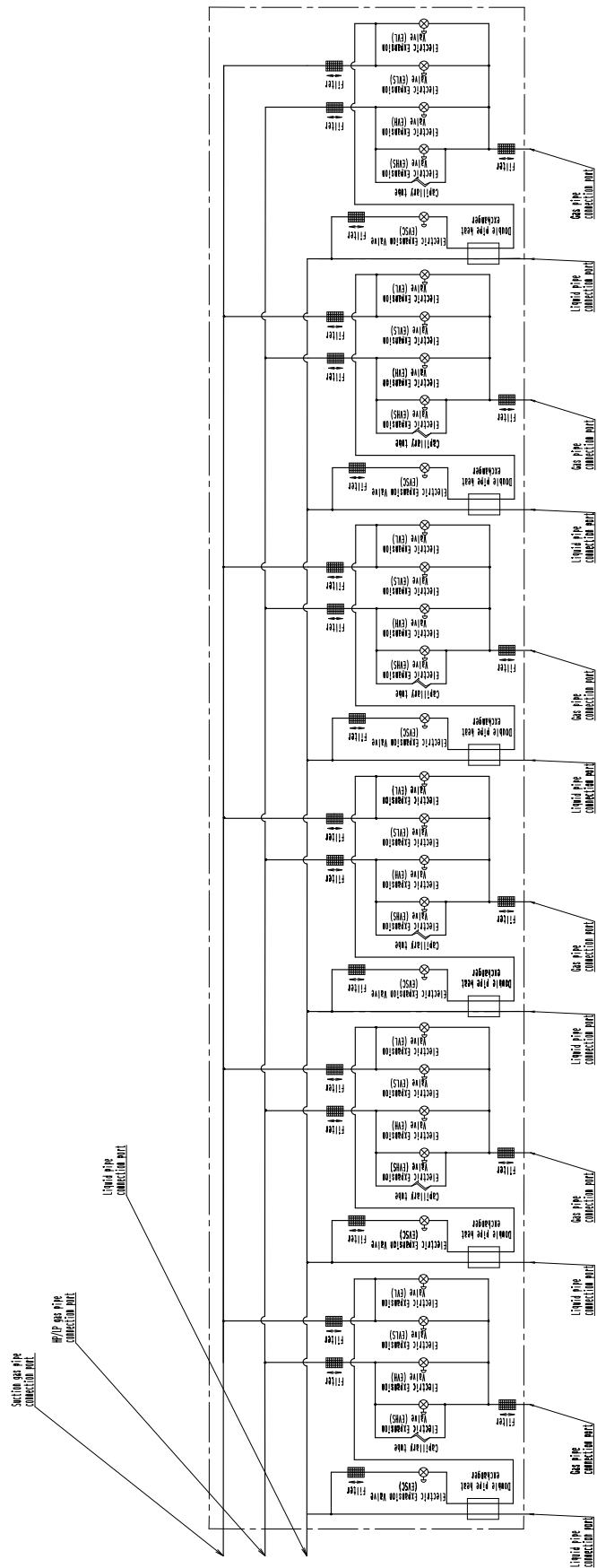

3D064149

2. Wiring Diagrams for Reference

2.1 Outdoor Unit

RQYQ140, 180PY1
RQE140, 180, 212PY1

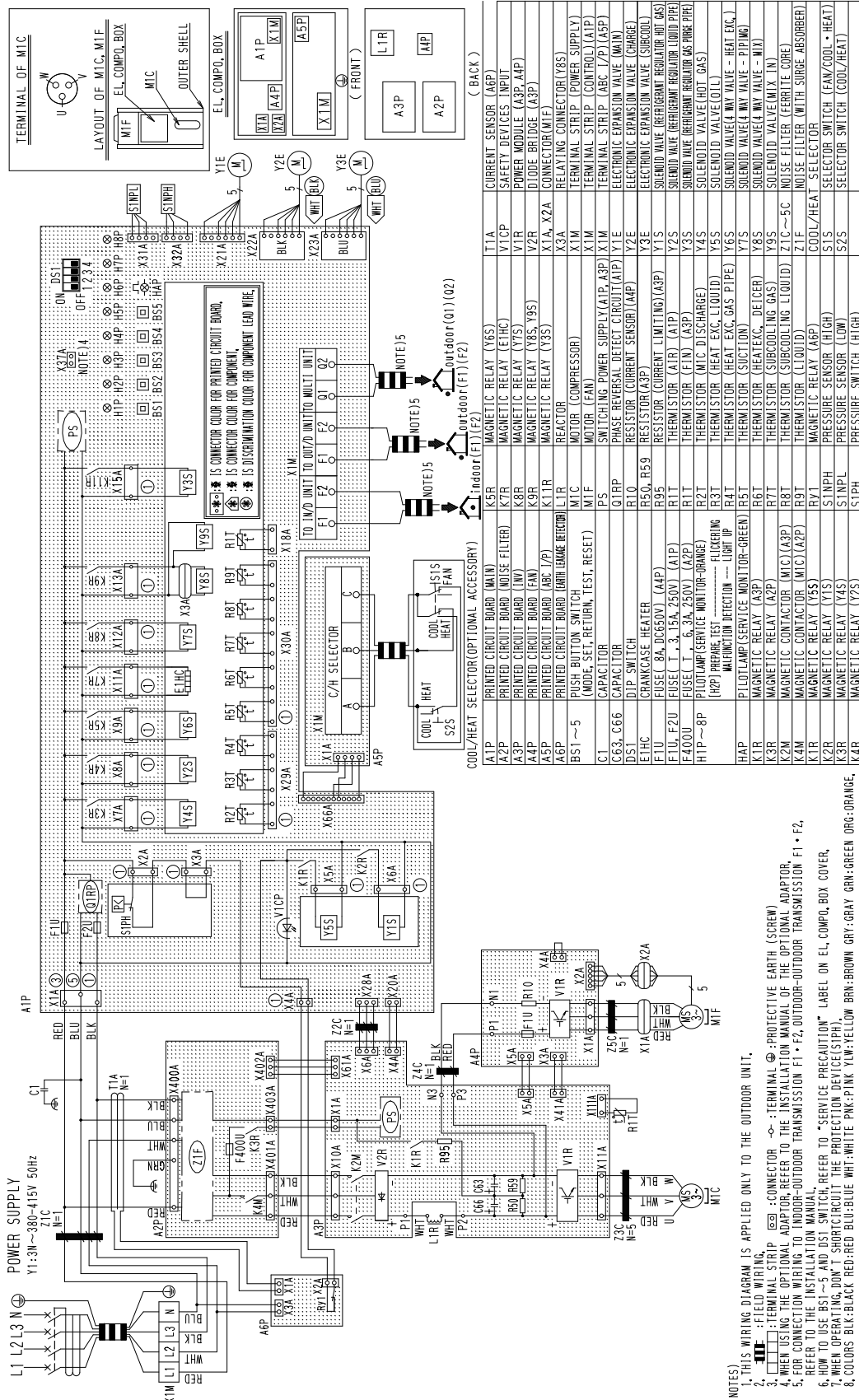

3D066011B

BSV4Q100PV1

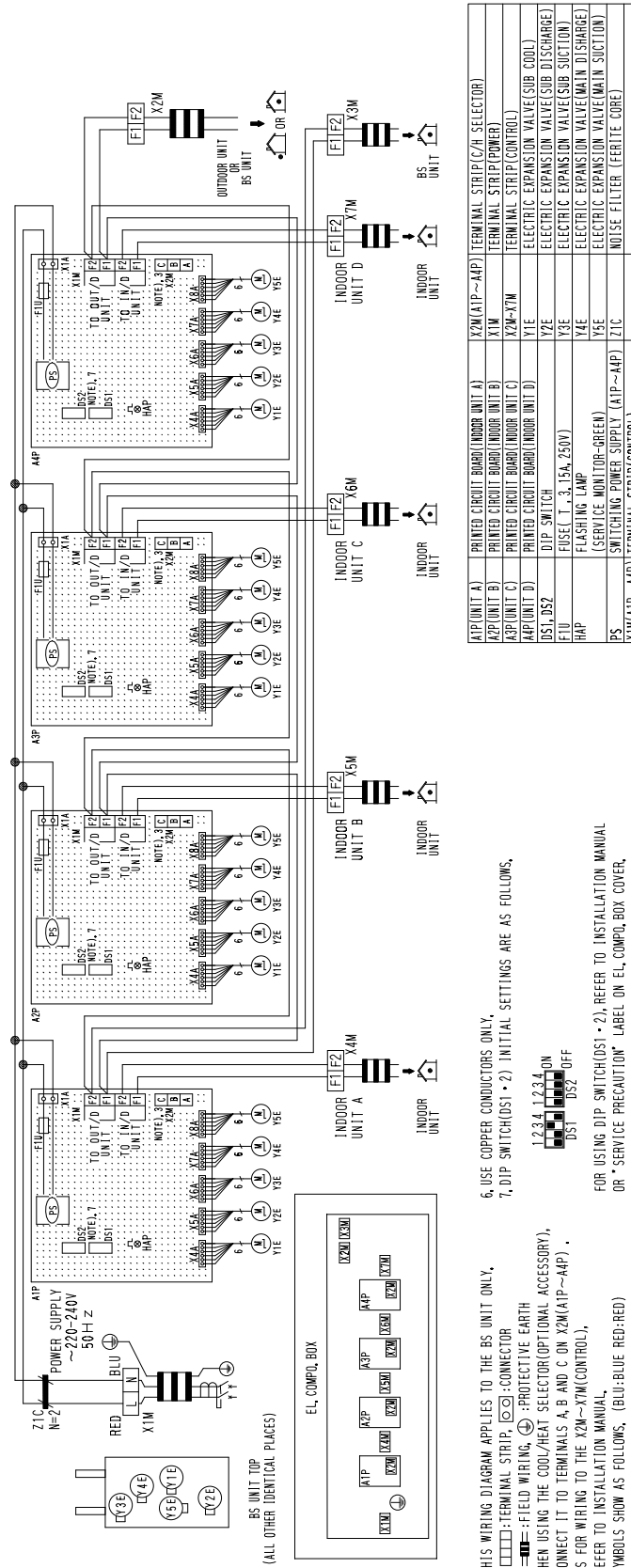

- NOTES) 1. THIS WIRING DIAGRAM APPLIES TO THE BS UNIT ONLY.
 2. : TERMINAL STRIP, : PROTECTIVE EARTH
 3. WHEN USING THE COOL/HEAT SELECTOR (OPTIONAL ACCESSORY), CONNECT IT TO TERMINALS A, B AND C ON X2M(A1P~A1P).
 4. AS FOR WIRING TO THE X2M~X7M(CONTROL), REFER TO INSTALLATION MANUAL.
 5. SYMBOLS SHOW AS FOLLOWS, (BLU: BLUE, RED: RED)
 6. USE COPPER CONDUCTORS ONLY.
 7. DIP SWITCH(DS1 • 2) INITIAL SETTINGS ARE AS FOLLOWS,
 1 2 3 4
 ON DS1
 OFF DS2
- FOR USING DIP SWITCH(DS1 • 2), REFER TO INSTALLATION MANUAL
 OR * SERVICE PRECAUTION* LABEL ON EL COMPQ BOX COVER,

| | | | |
|--------------|---------------------------------------|--------------|--|
| A1P(UNIT A) | PRINTED CIRCUIT BOARD (INDOOR UNIT A) | X2M(A1P~A1P) | TERMINAL STRIP(C/A SELECTOR) |
| A2P(UNIT B) | PRINTED CIRCUIT BOARD (INDOOR UNIT B) | X1M | TERMINAL STRIP(POWER) |
| A3P(UNIT C) | PRINTED CIRCUIT BOARD (INDOOR UNIT C) | X2M~X7M | TERMINAL STRIP(CONTROL) |
| A4P(UNIT D) | PRINTED CIRCUIT BOARD (INDOOR UNIT D) | Y1E | ELECTRIC EXPANSION VALVE(SUB COOL) |
| DS1, DS2 | DIP SWITCH | Y2E | ELECTRIC EXPANSION VALVE(SUB DISCHARGE) |
| F1U | FUSE(T . 3, 15A, 250V) | Y3E | ELECTRIC EXPANSION VALVE(SUB SUCTION) |
| H1P | FLASHING LAMP (SERVICE MONITOR-GREEN) | Y4E | ELECTRIC EXPANSION VALVE(MAIN SUCTION) |
| PS | SWITCHING POWER SUPPLY (A1P~A4P) | Y5E | ELECTRIC EXPANSION VALVE(MAIN DISCHARGE) |
| X1M(A1P~A4P) | TERMINAL STRIP(CONTROL) | Z1C | NOISE FILTER (FERRITE CORE) |

3D063928B

3. Option List

3.1 Option Lists (Outdoor Unit)

| | | | |
|--|---------------|--|---|
| Series | | VRV III-Q | |
| Model | | RQYQ140PY1 | RQYQ180PY1 |
| Option name | | RQCYQ280PY1 RQCYQ360PY1 | RQCYQ460PY1 RQCYQ500PY1 |
| Cool/Heat selector | | KRC19-26A | |
| Fixing box | | KJB111A | |
| Distributive piping | REFNET header | KHRP26M22H(Max. 4 branch) KHRP26M33H(Max. 8 branch) | KHRP26M22H(Max. 4 branch) KHRP26M33H(Max. 8 branch) KHRP26M72H(Max. 8 branch) |
| | REFNET joint | KHRP26A22T(Max. 4 branch) KHRP26A33T(Max. 8 branch) | KHRP26A22T(Max. 4 branch) KHRP26A33T(Max. 8 branch) KHRP26A72T(Max. 8 branch) |
| Pipe size reducer | | | |
| Outdoor unit multi connection piping kit | | BHFP22P36C | BHFP22P54C |

| | | | |
|--|---------------|---|--|
| Series | | VRV III-Q | |
| Model | | RQCEQ280PY1 RQCEQ360PY1 | RQCEQ460PY1 RQCEQ500PY1 |
| Option name | | RQCEQ712PY1 RQCEQ744PY1 RQCEQ816PY1 RQCEQ848PY1 | RQCEQ712PY1 RQCEQ744PY1 RQCEQ816PY1 RQCEQ848PY1 |
| Cool/Heat selector | | KRC19-26A | |
| Fixing box | | KJB111A | |
| Distributive piping | REFNET header | KHRP25M33H(Max. 8 branch), KHRP25M72H(Max. 8 branch) KHRP26M22H(Max. 4 branch), KHRP26M33H(Max. 8 branch) | KHRP25M33H(Max. 8 branch) KHRP25M72H(Max. 8 branch) KHRP25M73H(Max. 8 branch) KHRP26M22H(Max. 4 branch) KHRP26M33H(Max. 8 branch) |
| | REFNET joint | KHRP25A22T(Max. 4 branch), KHRP25A33T(Max. 8 branch) KHRP25A72T(Max. 8 branch), KHRP26A22T(Max. 4 branch) KHRP26A33T(Max. 8 branch) | KHRP25A22T(Max. 4 branch) KHRP25A33T(Max. 8 branch) KHRP25A72T(Max. 8 branch) KHRP25A73T(Max. 8 branch) KHRP26A22T(Max. 4 branch) KHRP26A33T(Max. 8 branch) |
| Pipe size reducer | | | |
| Outdoor unit multi connection piping kit | | BHFP26P36C | BHFP26P84C |

3D066354

4. Example of connection (R-410A Type)

■ Heat Pump series (RQ(C)YQ)

| Example of connection | | Example refrigerant branch using REFNET joint | | Example refrigerant branch using REFNET joint and REFNET header | | Example refrigerant branch using REFNET header | | | | | | | | | | | | | | | | | | | | | | | | | | | | | | | | | |
|---|---|--|---|---|--|---|----------------------------|--|------------|---------------|------------|----------------------------------|-----------------------------|-------|------------|---------------|------------|---------------|------------|-------|--------------------------|--|--|----------------------------------|-----------------------------|-------|------------|---------------|------------|---------------|------------|-------|--------------------------|-------------------------|----------------------------|---------|------------|---------|------------|
| <p>Example of connection (Connection of 8 indoor units)</p> <p>(≠1) “ ← ” indicate the Outdoor unit multi connection piping kit</p> <p>(≠2) In case of multi outdoor system, re-read to the first Outdoor unit multi connection piping kit as seen from the indoor unit.</p> | | Single outdoor system | | | | | | | | | | | | | | | | | | | | | | | | | | | | | | | | | | | | | |
| | | Multi outdoor system | | | | | | | | | | | | | | | | | | | | | | | | | | | | | | | | | | | | | |
| Maximum allowable length | Between outdoor (*2) and indoor units | Actual pipe length | Pipe length between outdoor (*2) and indoor units ≤ 120m Example unit [8] : a + b + c + d + e + f + g + p ≤ 120m | Example unit [6] : a + b + h ≤ 165m, unit [8] : a + i + k ≤ 120m | Example unit [8] : a + i ≤ 120m | | | | | | | | | | | | | | | | | | | | | | | | | | | | | | | | | | |
| | | Equivalent length | Equivalent pipe length between outdoor (*2) and indoor units ≤ 150m (assume equivalent pipe length of REFNET joint to be 0.5m, that of REFNET header to be 1m, calculation purposes) (See Note 1 - Next page) | | | | | | | | | | | | | | | | | | | | | | | | | | | | | | | | | | | | |
| | | Total extension length | Total pipe length from outdoor unit (*2) to all indoor units ≤ 300m | | | | | | | | | | | | | | | | | | | | | | | | | | | | | | | | | | | | |
| Allowable height length | Between outdoor unit and Outdoor unit multi connection piping kit (Only for multi system) | Actual pipe length | Pipe length between outdoor unit and outdoor unit multi connection piping kit ≤ 10m, equivalent length between outdoor unit and outdoor unit multi connection piping kit ≤ 13m | | | | | | | | | | | | | | | | | | | | | | | | | | | | | | | | | | | | |
| | Between outdoor and indoor units | Difference in height | Difference in height between outdoor and indoor units (H1) ≤ 50m (≤ 40m if the outdoor unit is below) | | | | | r ≤ 10m (Equivalent length: ≤ 13m) s ≤ 10m (Equivalent length: ≤ 13m) t ≤ 10m (Equivalent length: ≤ 13m) | | | | | | | | | | | | | | | | | | | | | | | | | | | | | | | |
| | Between indoor and indoor units | Difference in height | Difference in height between indoor units (H2) ≤ 15m | | | | | | | | | | | | | | | | | | | | | | | | | | | | | | | | | | | | |
| Between outdoor and outdoor units | Difference in height | Difference in height between outdoor unit (H3) ≤ 5m | | | | | | | | | | | | | | | | | | | | | | | | | | | | | | | | | | | | | |
| Allowable length after the branch | | Actual pipe length | Pipe length from first refrigerant branch kit (either REFNET joint or REFNET header) to indoor unit ≤ 40m Example unit [8] : b + c + d + e + f + g + p ≤ 40m | | Example unit [6] : b + h ≤ 40m, unit [8] : i + k ≤ 40m | | Example unit [8] : i ≤ 40m | | | | | | | | | | | | | | | | | | | | | | | | | | | | | | | | |
| Refrigerant branch kit selection | | <p>How to select the REFNET joint</p> <ul style="list-style-type: none"> When using REFNET joint at the first branch counted from the outdoor unit side. Choose from the following table in accordance with the outdoor unit capacity type. (Example: REFNET joint A) <table border="1"> <thead> <tr> <th>Outdoor unit capacity type</th> <th>Refrigerant branch kit name</th> </tr> </thead> <tbody> <tr> <td>Q140-180 type</td> <td>KHRP26A22T</td> </tr> <tr> <td>Q280 type</td> <td>KHRP26A33T</td> </tr> <tr> <td>Q360-540 type</td> <td>KHRP26A72T</td> </tr> </tbody> </table> <ul style="list-style-type: none"> Choose the REFNET joints other than that for the first branch from the following table in accordance with the total capacity index of all the indoor units connected below the REFNET joint. <table border="1"> <thead> <tr> <th>Indoor unit total capacity index</th> <th>Refrigerant branch kit name</th> </tr> </thead> <tbody> <tr> <td>< 200</td> <td>KHRP26A22T</td> </tr> <tr> <td>200 ≤ x < 290</td> <td>KHRP26A33T</td> </tr> <tr> <td>290 ≤ x < 640</td> <td>KHRP26A72T</td> </tr> <tr> <td>640 ≤</td> <td>KHRP26A73T + KHRP26M73TP</td> </tr> </tbody> </table> | | Outdoor unit capacity type | Refrigerant branch kit name | Q140-180 type | KHRP26A22T | Q280 type | KHRP26A33T | Q360-540 type | KHRP26A72T | Indoor unit total capacity index | Refrigerant branch kit name | < 200 | KHRP26A22T | 200 ≤ x < 290 | KHRP26A33T | 290 ≤ x < 640 | KHRP26A72T | 640 ≤ | KHRP26A73T + KHRP26M73TP | <p>How to select the REFNET header</p> <ul style="list-style-type: none"> Choose from the following table in accordance with the total capacity index of all the indoor units connected below the REFNET header. Note: 250 type indoor unit cannot be connected below the REFNET header. <table border="1"> <thead> <tr> <th>Indoor unit total capacity index</th> <th>Refrigerant branch kit name</th> </tr> </thead> <tbody> <tr> <td>< 200</td> <td>KHRP26M33H</td> </tr> <tr> <td>200 ≤ x < 290</td> <td>KHRP26M33H</td> </tr> <tr> <td>290 ≤ x < 640</td> <td>KHRP26M72H</td> </tr> <tr> <td>640 ≤</td> <td>KHRP26M73H + KHRP26M73HP</td> </tr> </tbody> </table> <p>How to select the Outdoor unit multi connection piping kit (This is required when the system is multi outdoor unit system.)</p> <ul style="list-style-type: none"> Choose from the following table in accordance with the number of outdoor units. <table border="1"> <thead> <tr> <th>Number of outdoor units</th> <th>Connection piping kit name</th> </tr> </thead> <tbody> <tr> <td>2 units</td> <td>BHFP22P36C</td> </tr> <tr> <td>3 units</td> <td>BHFP22P54C</td> </tr> </tbody> </table> | | Indoor unit total capacity index | Refrigerant branch kit name | < 200 | KHRP26M33H | 200 ≤ x < 290 | KHRP26M33H | 290 ≤ x < 640 | KHRP26M72H | 640 ≤ | KHRP26M73H + KHRP26M73HP | Number of outdoor units | Connection piping kit name | 2 units | BHFP22P36C | 3 units | BHFP22P54C |
| Outdoor unit capacity type | Refrigerant branch kit name | | | | | | | | | | | | | | | | | | | | | | | | | | | | | | | | | | | | | | |
| Q140-180 type | KHRP26A22T | | | | | | | | | | | | | | | | | | | | | | | | | | | | | | | | | | | | | | |
| Q280 type | KHRP26A33T | | | | | | | | | | | | | | | | | | | | | | | | | | | | | | | | | | | | | | |
| Q360-540 type | KHRP26A72T | | | | | | | | | | | | | | | | | | | | | | | | | | | | | | | | | | | | | | |
| Indoor unit total capacity index | Refrigerant branch kit name | | | | | | | | | | | | | | | | | | | | | | | | | | | | | | | | | | | | | | |
| < 200 | KHRP26A22T | | | | | | | | | | | | | | | | | | | | | | | | | | | | | | | | | | | | | | |
| 200 ≤ x < 290 | KHRP26A33T | | | | | | | | | | | | | | | | | | | | | | | | | | | | | | | | | | | | | | |
| 290 ≤ x < 640 | KHRP26A72T | | | | | | | | | | | | | | | | | | | | | | | | | | | | | | | | | | | | | | |
| 640 ≤ | KHRP26A73T + KHRP26M73TP | | | | | | | | | | | | | | | | | | | | | | | | | | | | | | | | | | | | | | |
| Indoor unit total capacity index | Refrigerant branch kit name | | | | | | | | | | | | | | | | | | | | | | | | | | | | | | | | | | | | | | |
| < 200 | KHRP26M33H | | | | | | | | | | | | | | | | | | | | | | | | | | | | | | | | | | | | | | |
| 200 ≤ x < 290 | KHRP26M33H | | | | | | | | | | | | | | | | | | | | | | | | | | | | | | | | | | | | | | |
| 290 ≤ x < 640 | KHRP26M72H | | | | | | | | | | | | | | | | | | | | | | | | | | | | | | | | | | | | | | |
| 640 ≤ | KHRP26M73H + KHRP26M73HP | | | | | | | | | | | | | | | | | | | | | | | | | | | | | | | | | | | | | | |
| Number of outdoor units | Connection piping kit name | | | | | | | | | | | | | | | | | | | | | | | | | | | | | | | | | | | | | | |
| 2 units | BHFP22P36C | | | | | | | | | | | | | | | | | | | | | | | | | | | | | | | | | | | | | | |
| 3 units | BHFP22P54C | | | | | | | | | | | | | | | | | | | | | | | | | | | | | | | | | | | | | | |
| Example for indoor units connected downstream | | Example REFNET joint C: indoor units [3]+[4]+[5]+[6]+[7]+[8] | | Example REFNET joint B: indoor units [7]+[8] Example REFNET header: indoor units [1]+[2]+[3]+[4]+[5]+[6] | | Example REFNET header: indoor units [1]+[2]+[3]+[4]+[5]+[6]+[7]+[8] | | | | | | | | | | | | | | | | | | | | | | | | | | | | | | | | | |

Pipe size selection

△ Caution
Refer to the diagram below and select the appropriate piping from the tables on the right.

<Single Outdoor Unit System>

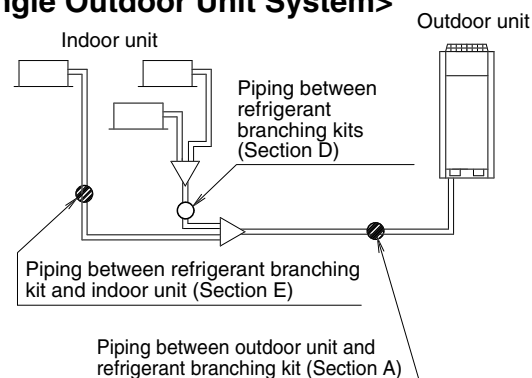

<Multiple Outdoor Unit System>

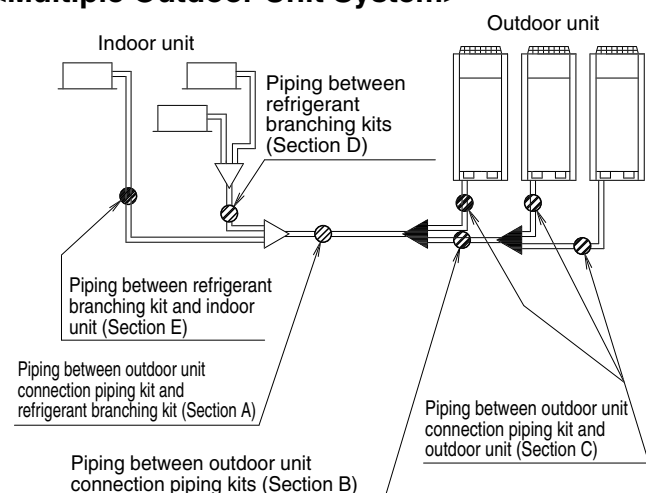

Piping between outdoor unit (*2) and refrigerant branch kit (part A)

- Choose from the following table in accordance with the outdoor unit system capacity type. (Note1)

| Outdoor capacity index | Piping size (O.D.) | | | |
|------------------------|--------------------|--------------|---------------|--------------|
| | Suction gas size | | Liquid pipe | |
| | Standard size | Maximum size | Standard size | Maximum size |
| Q140 | φ15.9 | φ25.4 | φ9.5 | φ12.7 |
| Q180 | φ19.1 | | | |
| Q280 | φ22.2 | φ28.6 | φ12.7 | φ15.9 |
| Q360 | φ25.4 | | | |
| Q460 | φ28.6 | φ41.3 | φ15.9 | φ19.1 |
| Q500 | | | | |
| Q540 | | | | |

Piping between outdoor unit multi connection piping kits (part B)

- Choose from the following table in accordance with the total capacity of all the outdoor units connected upstream

(unit: mm)

| Outdoor unit capacity type | Piping size (O.D.) | |
|----------------------------|--------------------|-------------|
| | Suction gas pipe | Liquid pipe |
| 280 | φ22.2 | φ9.5 |
| 360 | φ25.4 | φ12.7 |

Piping between outdoor unit multi connection piping kit and outdoor unit(part C)

- Choose from the following table in accordance with the capacity type of the outdoor unit connected

(unit: mm)

| Outdoor capacity index | Piping size (O.D.) | |
|------------------------|--------------------|-------------|
| | Gas pipe | Liquid pipe |
| Q140 | φ15.9 | φ9.5 |
| Q180 | φ19.1 | |

Piping between refrigerant branch kits

- Choose from the following table in accordance with the total capacity index of all the indoor units connected below this. (part D)
- Do not let the connection piping exceed the main refrigerant piping size. (Unit:mm)

| Indoor capacity index | Piping size (O.D.) | | | |
|-----------------------|--------------------|--------------|---------------|--------------|
| | Suction gas pipe | | Liquid pipe | |
| | Standard size | Maximum size | Standard size | Maximum size |
| < 11.2 kW | φ15.9 | φ19.1 | φ9.5 | φ12.7 |
| 11.2 kW ≤ x < 22.4 kW | | φ25.4 | | |
| 22.4 kW ≤ x < 33.0 kW | φ22.2 | φ28.6 | φ12.7 | φ15.9 |
| 33.0 kW ≤ x < 37.0 kW | φ25.4 | | | |
| 37.0 kW ≤ x < 47.0 kW | φ28.6 | | | |
| 47.0 kW ≤ x < 71.0 kW | φ34.9 | φ34.9 | φ15.9 | φ19.1 |
| 71.0 kW ≤ | | | | |

Piping between refrigerant branch kit and indoor unit

- Match to the size of the connection piping on the indoor unit.

(part E)

(Unit:mm)

| Indoor capacity index | Piping size (O.D.) | | | |
|-----------------------|--------------------|--------------|---------------|--------------|
| | Suction gas pipe | | Liquid pipe | |
| | Standard size | Maximum size | Standard size | Maximum size |
| Q20 | φ12.7 | φ15.9 | φ6.4 | φ9.5 |
| Q25 | | | | |
| Q32 | | | | |
| Q40 | | | | |
| Q50 | | | | |
| Q63 | φ15.9 | φ19.1 | φ9.5 | φ12.7 |
| Q80 | | | | |
| Q100 | | | | |
| Q125 | φ19.1 | φ25.4 | φ9.5 | φ15.9 |
| Q200 | | | | |
| Q250 | | | | |

How to calculate the additional refrigerant to be charged

Additional refrigerant to be charged R (kg)
(R should be rounded off in units of 0.1kg.)

$$R = \left(\begin{array}{l} \left(\begin{array}{l} \text{Total length (m)} \\ \text{of liquid piping} \\ \text{size at } \phi 19.1 \end{array} \right) \times 0.26 \\ + \left(\begin{array}{l} \text{Total length (m)} \\ \text{of liquid piping} \\ \text{size at } \phi 15.9 \end{array} \right) \times 0.18 \\ + \left(\begin{array}{l} \text{Total length (m)} \\ \text{of liquid piping} \\ \text{size at } \phi 12.7 \end{array} \right) \times 0.12 \\ + \left(\begin{array}{l} \text{Total length (m)} \\ \text{of liquid piping} \\ \text{size at } \phi 9.5 \end{array} \right) \times 0.059 \\ + \left(\begin{array}{l} \text{Total length (m)} \\ \text{of liquid piping} \\ \text{size at } \phi 6.4 \end{array} \right) \times 0.022 \end{array} \right) - \begin{array}{|c|c|c|c|} \hline \text{RQYQ140} & 2.4 \text{ kg} & \text{RQCYQ460} & 11.2 \text{ kg} \\ \hline \text{RQYQ180} & 2.4 \text{ kg} & \text{RQCYQ500} & 11.2 \text{ kg} \\ \hline \text{RQCYQ280} & 6.8 \text{ kg} & \text{RQCYQ540} & 11.2 \text{ kg} \\ \hline \text{RQCYQ360} & 6.8 \text{ kg} & & \\ \hline \end{array} + \begin{array}{|c|c|} \hline \text{A} \leq 100\% & 0 \text{ kg} \\ \hline \text{A} > 100\% & 0.5 \text{ kg} \\ \hline \end{array}$$

(A: The ratio of total capacity index of connectable indoor units to outdoor capacity index (%))

Example for refrigerant branch using REFNET joint and REFNET header

In case the outdoor unit is RQCYQ540PY1 type and the piping lengths are as at right

| | | | | |
|----------------|---------------|---------------|---------------|---------------|
| a: φ15.9 × 30m | d: φ9.5 × 20m | g: φ9.5 × 20m | j: φ6.4 × 10m | s: φ9.5 × 1m |
| b: φ15.9 × 10m | e: φ9.5 × 20m | h: φ9.5 × 20m | k: φ6.4 × 10m | t: φ9.5 × 1m |
| c: φ9.5 × 20m | f: φ9.5 × 20m | i: φ9.5 × 10m | r: φ9.5 × 1m | u: φ12.7 × 3m |

Total capacity of indoor unit: 116%

$$R = \left(\begin{array}{l} 40 \times 0.18 \\ + 3 \times 0.12 \\ + 1.33 \times 0.059 \\ + 20 \times 0.022 \end{array} \right) - 11.2 + 0.5 = 5.147 \Rightarrow 5.1 \text{ kg}$$

↑ a, b
 ↑ u
 ↑ c~i, r~t
 ↑ j, k
 RQCYQ540PY1
 ↑ 116%

***Note 1**

When the equivalent pipe length between outdoor unit multi connection piping kit and indoor units is 90m or more, the size of main pipes (both gas-side and liquid-side) must be increased to the following table.

Depending on the length of the piping, the capacity may drop, but even in such case it is able to increase the size of main pipes.

(Refer to figure below)

1. Outdoor unit
2. Main pipes
3. Increase
4. The first refrigerant branch kit
5. Indoor unit

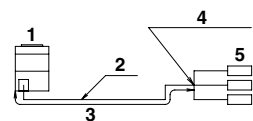

| Model name of outdoor unit system | Piping size (O.D.) | |
|-----------------------------------|--------------------|----------------------|
| | Gas pipe | Liquid pipe |
| RQYQ140 | φ15.9 → φ19.1 | φ9.5 → Not increased |
| RQYQ180 | φ19.1 → φ22.2 | φ9.5 → Not increased |
| RQCYQ280 | φ22.2 → φ25.4 | φ9.5 → φ12.7 |
| RQCYQ360 | φ25.4 → φ28.6 | φ12.7 → φ15.9 |
| RQCYQ460 | φ28.6 → φ34.9 | |
| RQCYQ500, 540 | | φ15.9 → φ19.1 |

Heat Recovery series (RQ(C)EQ)

| Example of connection (Connection of 8 indoor units) | | Branch with REFNET joint | Branch with REFNET joint and header | Branch with REFNET header | | | | | | | | | | | | | | | | | | | | | | | | | | | | | | | | | | | | | | | | | | | | | | | |
|--|--|---|---|---|-----------------------------|-----------|------------|---------------|------------------------|-------------|------------------------|----------------------------------|-----------------------------|--|---------|---------|---------|------------|------------|---------------|------------|------------|---------------|------------------------|------------|---------|------------------------|---|--|----------------------------------|-----------------------------|--|---------|---------|---------|------------|--------------------------|---------------|------------|---------------|------------------------|------------|---------|------------------------|------------------------|------------------------|----------------------------|---------|------------|---------|------------|
| <p>Outdoor unit side — BS Unit — Indoor unit side</p> <p>① Piping from outdoor unit to BS unit (Bold): 3 pipes { Suction gas pipe, HP/LP gas pipe, Liquid pipe }</p> <p>② Piping from BS unit to indoor unit or Piping from Refrigerant branch kit to indoor unit used as cooling only (Thin): 2 pipes { (Suction) gas pipe, Liquid pipe }</p> <p>(*1) "←" Indicate the Outdoor unit multi connection piping kit. (*2) In case of multi outdoor system, re-read "outdoor unit" to "the first Outdoor unit multi connection piping kit" as seen from the indoor unit.</p> | | <p>First outdoor unit multi connection piping kit</p> <p>B1~B4 : BS Unit 1~6 : Indoor unit (Cool/Heat selection possible) 7, 8 : Indoor unit (Cooling only)</p> | <p>Outdoor unit</p> <p>B1~B5 : BS Unit 1~4, 7, 8 : Indoor unit (Cool/Heat selection possible) 5, 6 : Indoor unit (Cooling only)</p> | <p>Outdoor unit</p> <p>B1~B4 : BS Unit 1~6 : Indoor unit (Cool/Heat selection possible) 7, 8 : Indoor unit (Cooling only)</p> | | | | | | | | | | | | | | | | | | | | | | | | | | | | | | | | | | | | | | | | | | | | | | | |
| Maximum allowable length | Between outdoor unit (*2) and indoor unit | Actual pipe length | Pipe length between outdoor unit (*2) and indoor unit ≤ 120m Example 8 : a + b + c + d + e + s ≤ 120m Example 6 : a + b + l ≤ 120m, 8 : a + m + n + p ≤ 120m Example 8 : a + o ≤ 120m | | | | | | | | | | | | | | | | | | | | | | | | | | | | | | | | | | | | | | | | | | | | | | | | |
| | | Equivalent length | Equivalent pipe length between outdoor unit (*2) and indoor unit ≤ 150m (Note 1) (Assume equivalent pipe length of REFNET joint to be 0.5m, that of REFNET header to be 1m, that of BSVQ100, 160 to be 4m, that of BSVQ250 to be 6m for calculation purposes) (In case of BSV4Q100PV1 and BSV6Q100PV1 (combined type BS unit), calculate at 4m per 1 unit.) | | | | | | | | | | | | | | | | | | | | | | | | | | | | | | | | | | | | | | | | | | | | | | | | |
| | | Total extension length | Total piping length from outdoor unit (*2) to all indoor unit ≤ 300m | | | | | | | | | | | | | | | | | | | | | | | | | | | | | | | | | | | | | | | | | | | | | | | | |
| | Between first outdoor unit multi connection piping kit and outdoor unit (in case of multi system) | Actual and Equivalent pipe length | Actual pipe length from first outdoor unit multi connection piping kit to outdoor unit ≤ 10m Equivalent pipe length from first outdoor unit multi connection piping kit to outdoor unit ≤ 13m | | | | | | | | | | | | | | | | | | | | | | | | | | | | | | | | | | | | | | | | | | | | | | | | |
| Allowable height difference | Between outdoor and indoor units | Difference in height | Difference in height between outdoor unit and indoor unit (H1) ≤ 50m (Max 40m if the outdoor unit is below) | | | | | | | | | | | | | | | | | | | | | | | | | | | | | | | | | | | | | | | | | | | | | | | | |
| | Between indoor and indoor units | Difference in height | Difference in height between adjacent indoor units (H2) ≤ 15m | | | | | | | | | | | | | | | | | | | | | | | | | | | | | | | | | | | | | | | | | | | | | | | | |
| | Between outdoor and outdoor units | Difference in height | Difference in height between adjacent outdoor units (H3) ≤ 5m | | | | | | | | | | | | | | | | | | | | | | | | | | | | | | | | | | | | | | | | | | | | | | | | |
| | | | <p>r ≤ 10m (Equivalent length ≤ 13m) u + s ≤ 10m (Equivalent length ≤ 13m) u + t ≤ 10m (Equivalent length ≤ 13m)</p> | | | | | | | | | | | | | | | | | | | | | | | | | | | | | | | | | | | | | | | | | | | | | | | | |
| Allowable length after the branch | Actual pipe length | Actual pipe length from first refrigerant branch kit (either REFNET joint or REFNET header) to indoor unit ≤ 40m Example 8 : b + c + d + e + s ≤ 40m Example 6 : b + l ≤ 40m, 8 : m + n + p ≤ 40m Example 8 : o ≤ 40m | | | | | | | | | | | | | | | | | | | | | | | | | | | | | | | | | | | | | | | | | | | | | | | | | |
| Outdoor unit multi connection piping kit and Refrigerant branch kit selection | <p>! Refrigerant branch kit must be used to prescribed kit. • Use this table for kit selection.</p> | How to select the REFNET joint | | How to select the REFNET header | | | | | | | | | | | | | | | | | | | | | | | | | | | | | | | | | | | | | | | | | | | | | | | |
| | | <p>• When using REFNET joint at the first branch counted from the outdoor unit side, choose from the following table in accordance with the outdoor unit capacity type. (Example : REFNET joint A)</p> <table border="1"> <tr> <th>Outdoor unit capacity type</th> <th>Refrigerant branch kit name</th> </tr> <tr> <td>Q280 type</td> <td>KHRP25A33T</td> </tr> <tr> <td>Q360~712 type</td> <td>KHRP25A72T+KHRP25M72TP</td> </tr> <tr> <td>Q744 type ~</td> <td>KHRP25A73T+KHRP25M73TP</td> </tr> </table> <p>• Choose the REFNET joints other than the first branch from the following table in accordance with the total capacity index of all the indoor units connected below the REFNET joint</p> <table border="1"> <tr> <th rowspan="2">Indoor unit total capacity index</th> <th colspan="2">Refrigerant branch kit name</th> </tr> <tr> <th>3 pipes</th> <th>2 pipes</th> </tr> <tr> <td>x < 200</td> <td>KHRP25A22T</td> <td>KHRP26A22T</td> </tr> <tr> <td>200 ≤ x < 290</td> <td>KHRP25A33T</td> <td>KHRP26A33T</td> </tr> <tr> <td>290 ≤ x < 640</td> <td>KHRP25A72T+KHRP25M72TP</td> <td>KHRP26A72T</td> </tr> <tr> <td>640 ≤ x</td> <td>KHRP25A73T+KHRP25M73TP</td> <td>—</td> </tr> </table> | | Outdoor unit capacity type | Refrigerant branch kit name | Q280 type | KHRP25A33T | Q360~712 type | KHRP25A72T+KHRP25M72TP | Q744 type ~ | KHRP25A73T+KHRP25M73TP | Indoor unit total capacity index | Refrigerant branch kit name | | 3 pipes | 2 pipes | x < 200 | KHRP25A22T | KHRP26A22T | 200 ≤ x < 290 | KHRP25A33T | KHRP26A33T | 290 ≤ x < 640 | KHRP25A72T+KHRP25M72TP | KHRP26A72T | 640 ≤ x | KHRP25A73T+KHRP25M73TP | — | <p>• Choose from the following table in accordance with the total capacity index of all the indoor units connected below the REFNET header. • 250 type indoor unit can not be connected below the REFNET header.</p> <table border="1"> <tr> <th rowspan="2">Indoor unit total capacity index</th> <th colspan="2">Refrigerant branch kit name</th> </tr> <tr> <th>3 pipes</th> <th>2 pipes</th> </tr> <tr> <td>x < 200</td> <td rowspan="2">KHRP25M33H</td> <td>KHRP26M22H or KHRP26M33H</td> </tr> <tr> <td>200 ≤ x < 290</td> <td>KHRP26M33H</td> </tr> <tr> <td>290 ≤ x < 640</td> <td>KHRP25M72H+KHRP25M72HP</td> <td>KHRP26M72H</td> </tr> <tr> <td>640 ≤ x</td> <td>KHRP25M73H+KHRP25M73HP</td> <td>KHRP26M73H+KHRP26M73HP</td> </tr> </table> <p>How to select the outdoor unit multi connection piping kit (This is required when the system is multi outdoor unit system.)</p> <p>• Choose from the following table in accordance with the number of outdoor units.</p> <table border="1"> <tr> <th>Number of outdoor unit</th> <th>Connecting piping kit name</th> </tr> <tr> <td>2 units</td> <td>BHFP26P36C</td> </tr> <tr> <td>3 units</td> <td>BHFP26P63C</td> </tr> <tr> <td>4 units</td> <td>BHFP26P84C</td> </tr> </table> | Indoor unit total capacity index | Refrigerant branch kit name | | 3 pipes | 2 pipes | x < 200 | KHRP25M33H | KHRP26M22H or KHRP26M33H | 200 ≤ x < 290 | KHRP26M33H | 290 ≤ x < 640 | KHRP25M72H+KHRP25M72HP | KHRP26M72H | 640 ≤ x | KHRP25M73H+KHRP25M73HP | KHRP26M73H+KHRP26M73HP | Number of outdoor unit | Connecting piping kit name | 2 units | BHFP26P36C | 3 units | BHFP26P63C |
| Outdoor unit capacity type | Refrigerant branch kit name | | | | | | | | | | | | | | | | | | | | | | | | | | | | | | | | | | | | | | | | | | | | | | | | | | |
| Q280 type | KHRP25A33T | | | | | | | | | | | | | | | | | | | | | | | | | | | | | | | | | | | | | | | | | | | | | | | | | | |
| Q360~712 type | KHRP25A72T+KHRP25M72TP | | | | | | | | | | | | | | | | | | | | | | | | | | | | | | | | | | | | | | | | | | | | | | | | | | |
| Q744 type ~ | KHRP25A73T+KHRP25M73TP | | | | | | | | | | | | | | | | | | | | | | | | | | | | | | | | | | | | | | | | | | | | | | | | | | |
| Indoor unit total capacity index | Refrigerant branch kit name | | | | | | | | | | | | | | | | | | | | | | | | | | | | | | | | | | | | | | | | | | | | | | | | | | |
| | 3 pipes | 2 pipes | | | | | | | | | | | | | | | | | | | | | | | | | | | | | | | | | | | | | | | | | | | | | | | | | |
| x < 200 | KHRP25A22T | KHRP26A22T | | | | | | | | | | | | | | | | | | | | | | | | | | | | | | | | | | | | | | | | | | | | | | | | | |
| 200 ≤ x < 290 | KHRP25A33T | KHRP26A33T | | | | | | | | | | | | | | | | | | | | | | | | | | | | | | | | | | | | | | | | | | | | | | | | | |
| 290 ≤ x < 640 | KHRP25A72T+KHRP25M72TP | KHRP26A72T | | | | | | | | | | | | | | | | | | | | | | | | | | | | | | | | | | | | | | | | | | | | | | | | | |
| 640 ≤ x | KHRP25A73T+KHRP25M73TP | — | | | | | | | | | | | | | | | | | | | | | | | | | | | | | | | | | | | | | | | | | | | | | | | | | |
| Indoor unit total capacity index | Refrigerant branch kit name | | | | | | | | | | | | | | | | | | | | | | | | | | | | | | | | | | | | | | | | | | | | | | | | | | |
| | 3 pipes | 2 pipes | | | | | | | | | | | | | | | | | | | | | | | | | | | | | | | | | | | | | | | | | | | | | | | | | |
| x < 200 | KHRP25M33H | KHRP26M22H or KHRP26M33H | | | | | | | | | | | | | | | | | | | | | | | | | | | | | | | | | | | | | | | | | | | | | | | | | |
| 200 ≤ x < 290 | | KHRP26M33H | | | | | | | | | | | | | | | | | | | | | | | | | | | | | | | | | | | | | | | | | | | | | | | | | |
| 290 ≤ x < 640 | KHRP25M72H+KHRP25M72HP | KHRP26M72H | | | | | | | | | | | | | | | | | | | | | | | | | | | | | | | | | | | | | | | | | | | | | | | | | |
| 640 ≤ x | KHRP25M73H+KHRP25M73HP | KHRP26M73H+KHRP26M73HP | | | | | | | | | | | | | | | | | | | | | | | | | | | | | | | | | | | | | | | | | | | | | | | | | |
| Number of outdoor unit | Connecting piping kit name | | | | | | | | | | | | | | | | | | | | | | | | | | | | | | | | | | | | | | | | | | | | | | | | | | |
| 2 units | BHFP26P36C | | | | | | | | | | | | | | | | | | | | | | | | | | | | | | | | | | | | | | | | | | | | | | | | | | |
| 3 units | BHFP26P63C | | | | | | | | | | | | | | | | | | | | | | | | | | | | | | | | | | | | | | | | | | | | | | | | | | |
| 4 units | BHFP26P84C | | | | | | | | | | | | | | | | | | | | | | | | | | | | | | | | | | | | | | | | | | | | | | | | | | |
| Example for indoor units connected downstream | Example REFNET joint C : Indoor units 5 + 6 + 7 + 8 | Example REFNET joint B : Indoor units 7 + 8 | Example REFNET header : Indoor units 1 + 2 + 3 + 4 + 5 + 6 | Example REFNET header : Indoor units 1 + 2 + 3 + 4 + 5 + 6 + 7 + 8 | | | | | | | | | | | | | | | | | | | | | | | | | | | | | | | | | | | | | | | | | | | | | | | |

Pipe size selection

Refer to the diagram below and select the appropriate piping from the tables on the right.

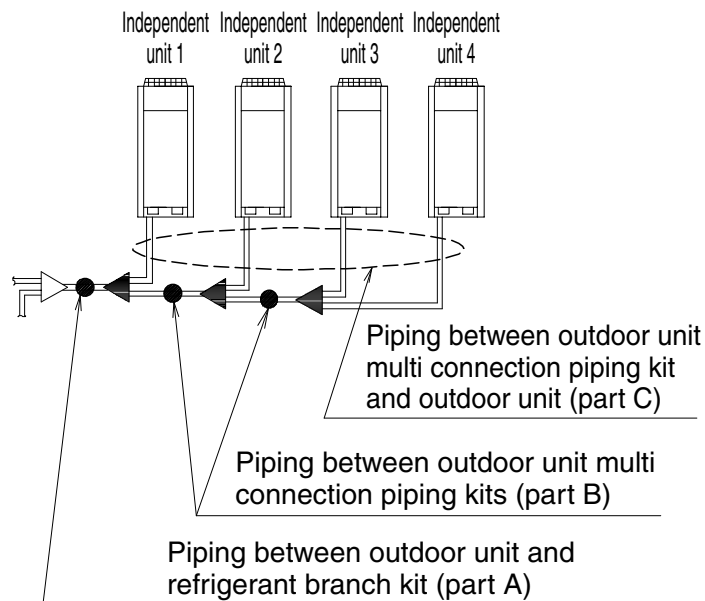

Piping between outdoor unit (*2) and refrigerant branch kit (part A)

- Choose from the following table in accordance with the outdoor unit system capacity type.

| Model name of outdoor unit system | Piping size (O. D.) | | | | | |
|-----------------------------------|---------------------|--------------|----------------|--------------|---------------|--------------|
| | Suction gas pipe | | HP/LP gas pipe | | Liquid pipe | |
| | Standard size | Maximum size | Standard size | Maximum size | Standard size | Maximum size |
| Q280 type | φ22.2 | φ28.6 | φ19.1 | φ22.2 | φ9.5 | φ12.7 |
| Q360 type | φ25.4 | φ28.6 | φ19.1 | φ22.2 | φ12.7 | φ15.9 |
| Q460 type | φ28.6 | φ34.9 | φ22.2 | φ25.4 | φ15.9 | φ19.1 |
| Q500 type | | | φ25.4 | φ28.6 | | |
| Q540 type | | | | | φ25.4 | φ28.6 |
| Q636 type | | | φ25.4 | φ28.6 | | |
| Q712 type | φ34.9 | φ41.3 | | | φ28.6 | φ19.1 |
| Q744 type | | | φ28.6 | φ28.6 | | |
| Q816 type | φ28.6 | φ28.6 | | | | |
| Q848 type | | | φ28.6 | φ28.6 | | |

Piping between outdoor unit multi connection piping kits (part B)

- Choose from the following table in accordance with the total capacity of all the outdoor units connected upstream. (unit : mm)

| Outdoor unit capacity type | Piping size (O. D.) | | |
|----------------------------|---------------------|----------------|-------------|
| | Suction gas pipe | HP/LP gas pipe | Liquid pipe |
| 280-320 | φ22.2 | φ19.1 | φ9.5 |
| 360~392 | φ25.4 | φ19.1 | φ12.7 |
| 424 | φ28.6 | φ22.2 | φ15.9 |
| 500~532 | | φ25.4 | φ15.9 |
| 604~636 | | | |

Piping between outdoor unit multi connection piping kit and outdoor unit (part C)

- Choose from the following table in accordance with the capacity type of the outdoor unit connected. (unit : mm)

| Outdoor unit capacity type | Piping size (O. D.) | | |
|----------------------------|---------------------|----------------|-------------|
| | Suction gas pipe | HP/LP gas pipe | Liquid pipe |
| Q140 type | φ15.9 | φ12.7 | φ9.5 |
| Q180-212 type | φ19.1 | φ15.9 | |

Piping between refrigerant branch kits

Piping between refrigerant branch kit and BS unit

Piping between BS unit and refrigerant branch kit

- Choose from the following table in accordance with the total capacity type of all the indoor units connected downstream.

*1 Connection piping must not exceed the refrigerant piping size between outdoor unit and refrigerant branch kit (part A).

*2 When selecting 2 pipes line (gas pipe and liquid pipe), use suction gas pipe column for gas pipe and liquid pipe column for liquid pipe. (unit : mm)

| Indoor capacity index | Piping size (O.D.) | | | | | |
|-----------------------|--------------------|--------------|----------------|--------------|---------------|--------------|
| | Suction gas pipe | | HP/LP gas pipe | | Liquid pipe | |
| | Standard size | Maximum size | Standard size | Maximum size | Standard size | Maximum size |
| < 56 kW | φ12.7 | φ15.9 | φ9.5 | φ12.7 | φ6.4 | φ9.5 |
| 56 kW ≤ x < 112 kW | φ15.9 | φ19.1 | φ12.7 | φ15.9 | φ9.5 | φ12.7 |
| 112 kW ≤ x < 160 kW | | | | | | |
| 160 kW ≤ x < 180 kW | φ19.1 | φ25.4 | φ15.9 | φ19.1 | φ9.5 | φ15.9 |
| 180 kW ≤ x < 224 kW | | | | | | |
| 224 kW ≤ x < 330 kW | φ22.2 | φ28.6 | φ19.4 | φ22.2 | φ12.7 | φ15.9 |
| 330 kW ≤ x < 370 kW | φ25.4 | | | | | |
| 370 kW ≤ x < 470 kW | φ28.6 | φ34.9 | φ25.4 | φ28.6 | φ15.9 | φ19.1 |
| 470 kW ≤ x < 530 kW | | | | | | |
| 530 kW ≤ x < 710 kW | φ34.9 | φ41.3 | φ28.6 | φ28.6 | φ19.1 | φ22.2 |
| 710 kW ≤ x < 784 kW | | | | | | |
| 784 kW ≤ x < 1010 kW | φ34.9 | φ41.3 | φ28.6 | φ28.6 | φ19.1 | φ22.2 |
| 1010 kW ≤ | | | | | | |

Piping between refrigerant branch kit, BS unit and indoor unit

- Match to the size of the connection piping on the indoor unit. (unit : mm)

| Indoor capacity index | Piping size (O.D.) | | | |
|-----------------------|--------------------|--------------|---------------|--------------|
| | Suction gas pipe | | Liquid pipe | |
| | Standard size | Maximum size | Standard size | Maximum size |
| Q20 | φ12.7 | φ15.9 | φ6.4 | φ9.5 |
| Q25 | | | | |
| Q32 | | | | |
| Q40 | | | | |
| Q50 | φ15.9 | φ19.1 | φ9.5 | φ12.7 |
| Q63 | | | | |
| Q80 | | | | |
| Q100 | | | | |
| Q125 | | | | |
| Q200 | φ19.1 | φ28.6 | φ9.5 | φ15.9 |
| Q250 | | | | |

How to calculate the additional refrigerant to be charged

Additional refrigerant to be charged : R(kg)
(R should be rounded off in units of 0.1 kg.)

$$R = \left(\begin{aligned} &\left(\text{Total length(m) of liquid piping size at } \phi 22.2 \right) \times 0.37 \text{ kg/m} + \left(\text{Total length(m) of liquid piping size at } \phi 19.1 \right) \times 0.26 \text{ kg/m} \\ &+ \left(\text{Total length(m) of liquid piping size at } \phi 15.9 \right) \times 0.18 \text{ kg/m} + \left(\text{Total length(m) of liquid piping size at } \phi 12.7 \right) \times 0.12 \text{ kg/m} \\ &+ \left(\text{Total length(m) of liquid piping size at } \phi 9.5 \right) \times 0.059 \text{ kg/m} + \left(\text{Total length(m) of liquid piping size at } \phi 6.4 \right) \times 0.022 \text{ kg/m} \end{aligned} \right) \times 1.02 -$$

Correction amount by outdoor unit

| | | | |
|----------|-----|----------|------|
| RQCEQ280 | 5.2 | RQCEQ636 | 11.2 |
| RQCEQ360 | 5.8 | RQCEQ712 | 13.8 |
| RQCEQ460 | 9.1 | RQCEQ744 | 14.3 |
| RQCEQ500 | 9.4 | RQCEQ816 | 15.1 |
| RQCEQ540 | 9.7 | RQCEQ848 | 15.6 |

| | |
|----------|--------|
| A ≤ 100% | 0 kg |
| A > 100% | 0.5 kg |

(A: The ratio of total capacity index of connectable indoor units to outdoor capacity index (%))

Example for refrigerant branch using REFNET joint and REFNET header for the systems and each pipe length as shown below.

Outdoor system : RQCEQ848PY1
Total capacity of indoor unit : 116%

| | | | | | |
|-----------------|----------------|----------------|----------------|---------------|----------------|
| a : φ19.1 × 30m | e : φ9.5 × 10m | i : φ9.5 × 10m | m : φ9.5 × 20m | r : φ9.5 × 1m | v : φ15.9 × 3m |
| b : φ19.1 × 20m | f : φ9.5 × 10m | j : φ9.5 × 10m | n : φ9.5 × 10m | s : φ9.5 × 1m | w : φ12.7 × 3m |
| c : φ9.5 × 10m | g : φ9.5 × 10m | k : φ9.5 × 20m | o : φ6.4 × 10m | t : φ9.5 × 1m | |
| d : φ9.5 × 10m | h : φ9.5 × 10m | l : φ9.5 × 20m | p : φ6.4 × 10m | u : φ9.5 × 3m | |

$$R = (50 \times 0.26 + 3 \times 0.18 + 3 \times 0.12 + 156 \times 0.059 + 20 \times 0.022) \times 1.02 - 15.6 + 0.5$$

a, b
v
w
c~n, r~u
o, p
RQCEQ848PY1
116%

$$= 8.915 \longrightarrow 8.9 \text{ kg}$$

Round off in units of 0.1 kg.

Note 1.

When the equivalent pipe length between outdoor unit multi connection piping and indoor units is 90m or more, the size of main pipes on the liquid side (refer to figure 9) must be increased according to the right table. (Do not increase the size of the suction gas pipe and HP/LP gas pipe.)

| System | Liquid pipe |
|---------------|---------------|
| RQCEQ280P | φ9.5 → φ12.7 |
| RQCEQ360~460P | φ12.7 → φ15.9 |
| RQCEQ500~712P | φ15.9 → φ19.1 |
| RQCEQ744~848P | φ19.1 → φ22.2 |

(Refer to figure below.)

1. Outdoor unit
2. Main pipes
3. Increase only liquid pipe size
4. First refrigerant branch kit
5. BS unit
6. Indoor unit

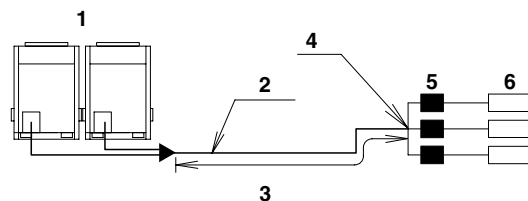

Warning



- Daikin Industries, Ltd.'s products are manufactured for export to numerous countries throughout the world. Daikin Industries, Ltd. does not have control over which products are exported to and used in a particular country. Prior to purchase, please therefore confirm with your local authorised importer, distributor and/or retailer whether this product conforms to the applicable standards, and is suitable for use, in the region where the product will be used. This statement does not purport to exclude, restrict or modify the application of any local legislation.
- Ask a qualified installer or contractor to install this product. Do not try to install the product yourself. Improper installation can result in water or refrigerant leakage, electrical shock, fire or explosion.
- Use only those parts and accessories supplied or specified by Daikin. Ask a qualified installer or contractor to install those parts and accessories. Use of unauthorised parts and accessories or improper installation of parts and accessories can result in water or refrigerant leakage, electrical shock, fire or explosion.
- Read the User's Manual carefully before using this product. The User's Manual provides important safety instructions and warnings. Be sure to follow these instructions and warnings.

If you have any enquiries, please contact your local importer, distributor and/or retailer.

Cautions on product corrosion

1. Air conditioners should not be installed in areas where corrosive gases, such as acid gas or alkaline gas, are produced.
2. If the outdoor unit is to be installed close to the sea shore, direct exposure to the sea breeze should be avoided. If you need to install the outdoor unit close to the sea shore, contact your local distributor.



JMI-0107

Organization:
DAIKIN INDUSTRIES, LTD.
AIR CONDITIONING MANUFACTURING DIVISION

Scope of Registration:
THE DESIGN/DEVELOPMENT AND MANUFACTURE OF
COMMERCIAL AIR CONDITIONING, HEATING, COOLING,
REFRIGERATING EQUIPMENT, COMMERCIAL HEATING
EQUIPMENT, RESIDENTIAL AIR CONDITIONING
EQUIPMENT, HEAT RECLAIM VENTILATION, AIR
CLEANING EQUIPMENT, MARINE TYPE CONTAINER
REFRIGERATION UNITS, COMPRESSORS AND VALVES.



JQA-1452

Organization:
DAIKIN INDUSTRIES
(THAILAND) LTD.

Scope of Registration:
THE DESIGN/DEVELOPMENT
AND MANUFACTURE OF AIR
CONDITIONERS AND THE
COMPONENTS INCLUDING
COMPRESSORS USED FOR THEM



EC99J2044

All of the Daikin Group's business facilities and subsidiaries in Japan are certified under the ISO 14001 international standard for environment management.

Dealer

DAIKIN INDUSTRIES, LTD.

Head Office:
Umeda Center Bldg., 2-4-12, Nakazaki-Nishi,
Kita-ku, Osaka, 530-8323 Japan

Tokyo Office:
JR Shinagawa East Bldg., 2-18-1, Konan,
Minato-ku, Tokyo, 108-0075 Japan

http://www.daikin.com/global_ac/

©All rights reserved