

TECHNICAL CATALOGUE

MONO SPLIT

RAF-25RXB
RAF-35RXB
RAF-50RXB



RAC-25FXB
RAC-35FXB



RAC-50FXB



HITACHI

Specifications in this catalogue are subject to change without prior notice in order for HITACHI to bring in the latest innovations to their customers

Whilst every effort is made to ensure that all dimensions and specifications are correct, any printers' error not rectified are outside the control of HITACHI, who cannot be held responsible for the same

CONTENTS

CONTENTS	1
1 SPECIFICATIONS	3
1.1. FLOOR TYPE (RAF-25RXB/35RXB/50RXB)	3
1.2. FLOOR TYPE (RAC-25FXB/35FXB/50FXB)	4
2 DIMENSIONAL DATA	5
2.1. FLOOR TYPE: RAF-25RXB/35RXB/50RXB	5
2.2. FLOOR TYPE: RAC-25FXB/35FXB	6
2.3. FLOOR TYPE: RAC-50FXB	7
3 CAPACITIES TABLE	8
3.1. CAPACITY CHARACTERISTIC CURVES	8
3.1.1. RAF-25RXB/RAC-25FXB	8
3.1.2. RAF-35RXB/RAC-35FXB	8
3.1.3. RAF-50RXB/RAC-50FXB	9
3.2. CORRECTION FACTORS ACCORDING TO PIPING LENGTH	10
3.3. CORRECTION FACTORS ACCORDING TO DEFROSTING OPERATION	12
4 SOUND DATA	13
4.1. RAC-25FXB	13
4.2. RAC-35FXB	14
4.3. RAC-50FXB	15
5 WORKING RANGE	16
5.1. POWER SUPPLY	16
5.2. WORKING RANGE	16
6 ELECTRICAL DATA	17
6.1. INDOOR UNIT	17
6.2. OUTDOOR UNIT	17
7 WIRING DIAGRAM	18
7.1. RAF-25RXB, RAF-35RXB, RAF-50RXB	18
7.2. RAC-25FXB, RAC-35FXB	19
7.3. RAC-50FXB	20
8 REFRIGERANT CYCLE	21
8.1. FLOOR TYPE: RAF-25RXB/RAC-25FXB, RAF-35RXB/RAC-35FXB	21
8.2. FLOOR TYPE: RAF-50RXB / RAC-50FXB	22
9 CONTROL AND FUNCTION	23
9.1. WIRELESS REMOTE CONTROL FUNCTION	23
9.2. AUTO CHANGEOVER	24
9.3. SHIFT VALUE	24
9.4. OPERATION LOCK	25
9.5. SETTING THE PREVENTION OF MUTUAL INTERFERENCE	25
9.6. INTERMITTENT FAN SPEED SETTING	26
9.7. FAN SPEED SETTING IN THERMO OFF IN COOLING	27
9.8. ERROR CODE INFORMATION	28
9.9. ADDITIONAL FUNCTION VIA DIP-SWITCH SETTINGS	30
9.9.1. AUTO RESTART FUNCTION	30
9.9.2. HEATING/COOLING ONLY MODEL SELECTION	30

10	OPTION LIST	31
10.1.	WIRED REMOTE CONTROL – SPX-RCDB	31
10.1.1.	SHIFT VALUE	31
10.1.2.	ERROR CODE INFORMATION	32
10.2.	H-LINK ADAPTOR – PSC 6RAD	35
10.2.1.	SAFETY SUMMARY	35
10.2.2.	INSTALLATION WORK	35
10.2.3.	ELECTRICAL WIRING	36
10.2.4.	DIP SWITCH SETTING	37
10.2.5.	TEST RUN	38
10.3.	DRY CONTACT (SPX-WDC3) APPLICATION (USING DIP SWITCH)	39
10.4.	DISTRIBUTOR – SPX-DST1	41

1 SPECIFICATIONS

1.1. FLOOR TYPE (RAF-25RXB/35RXB/50RXB)

INDOOR	Unit	RAF-25RXB	RAF-35RXB	RAF-50RXB
Nominal capacity adjustable		no	no	no
Nominal Cooling capacity (min – max)	kW	2.50 (0.90 - 3.10)	3.5 (0.9 - 4.0)	5.0 (0.9 - 5.2)
Cooling sensible capacity	kW	2.5	2.9	3.8
Nominal Heating capacity (min – max)	kW	3.40 (0.90 - 4.40)	4.5 (0.9 - 5.0)	6.0 (0.9 - 8.1)
Noise level cooling (sound pressure) (SL / L / M / H)	dB(A)	20/26/31/38	20/26/31/39	22/29/36/43
Noise level heating (sound pressure) (SL / L / M / H)	dB(A)	20/26/31/38	20/26/31/39	22/29/36/44
Noise level (sound power)	dB(A)	55	56	59
Air flow cooling mode (SL / L / M / H)	m ³ /h	270/390/510/630	270/390/510/660	300/450/540/720
Air flow heating mode (SL / L / M / H)	m ³ /h	300/420/540/660	300/420/540/690	330/480/570/750
Fan Motor	W	38	38	38
Dehumidification	l/h	1.4	1.9	2.8
Dimensions (H x W x D)	mm	590 x 750 x 215	590 x 750 x 215	590 x 750 x 215
Weight	kg	15	15	15
Colour		ShadowWhite (5PB8.7/0.5)	ShadowWhite (5PB8.7/0.5)	ShadowWhite (5PB8.7/0.5)
Condensate Drain	mm	φ16	φ16	φ16
Running current (C/H)	A	0.67-5.13 / 0.50-4.87	0.67-6.0 / 0.50-5.87	2.17-9.13 / 2.17-11.74
Power supply		230V / 1Ph / 50Hz	230V / 1Ph / 50Hz	230V / 1Ph / 50Hz
Cable section (Interconnection)	mm ²	1.50 x 3 + EARTH	1.50 x 3 + EARTH	2.50 x 3 + EARTH
Piping diameter (Liq / Gas)		1/4" / 3/8"	1/4" / 3/8"	1/4" / 1/2"
Drain diameter (ext)	mm	φ16	φ16	φ16
Remote control (standard/optional)		RAR-6N4/ SPX-RCDB	RAR-6N4/ SPX-RCDB	RAR-6N4/ SPX-RCDB
Filter				
ACL Filter		Nano Titanium	Nano Titanium	Nano Titanium
ACL part name		SPX-CFH15	SPX-CFH15	SPX-CFH15
Pre-filter (Standard / Optional)		Stainless/-	Stainless/-	Stainless/-

NOTE:

1. The nominal cooling and heating capacity is the combined capacity of the HITACHI standard split system, and are based on the ISO 5151.

Operation Conditions		Cooling	Heating
Indoor Air Inlet Temperature	dB	27.0 °C	20.0 °C
	WB	19.0 °C	
Outdoor Air Inlet Temperature	dB	35.0 °C	7.0 °C
	WB		6.0 °C
Piping Length: 5.0 meters; Piping Lift: 0 meter			
dB: Dry Bulb; WB: Wet Bulb			

2. The Sound Pressure Level is based on the following conditions:

- Half height of the unit
- 1 meter from Discharge grille

The above data was measured in an anechoic chamber. Please take into consideration reflected sound of your specific site

1.2. FLOOR TYPE (RAC-25FXB/35FXB/50FXB)

OUTDOOR	UNIT	RAC-25FXB	RAC-35FXB	RAC-50FXB	
Nominal Cooling capacity (min - max)	kW	2.50 (0.90 - 3.10)	3.5 (0.9 - 4.0)	5.0 (0.9 - 5.2)	
Nominal Heating capacity (min - max)	kW	3.40 (0.90 - 4.40)	4.5 (0.9 - 5.0)	6.0 (0.9 - 8.1)	
Nominal cooling power input (min - max)	kW	0.580 (0.155 -1.180)	1.020 (0.155 -1.380)	1.560 (0.500 - 2.100)	
Nominal heating power input (min - max)	kW	0.790 (0.115 -1.120)	1.220 (0.115 -1.350)	1.600 (0.500 - 2.700)	
EER / COP		4.31/4.30	3.43/3.69	3.21/3.75	
SEER / SCOP		6.38/4.24	6.39/4.14	5.97/4.15	
Energy class (SEER/SCOP)		A++/A+	A++/A+	A+/A+	
Noise level cooling (sound pressure)	dB(A)	45	46	50	
Noise level heating (sound pressure)	dB(A)	47	48	52	
Noise level (sound power)	dB(A)	62	63	65	
Air flow (Cooling / Heating)	m ³ /h	1860/1620	1920/1620	2160 / 2160	
Dimensions (H x W x D)	mm	548 x 750 x 288	548 x 750 x 288	736 x 800 x 350	
Weight	kg	31.5	31.5	49.5	
Colour		Beige (5Y7/2)	Beige (5Y7/2)	Beige (5Y7/2)	
Power supply		230V / 1Ph / 50Hz	230V / 1Ph / 50Hz	230V / 1Ph / 50Hz	
Recommended fuse size	A	15	15	25	
Starting current (C/H)	A	3.31/4.24	5.17/5.98	7.11/8.10	
Running current (C/H)	A	0.67-5.13 / 0.50-4.87	0.67-6.0 / 0.50-5.87	2.17-9.13 / 2.17-11.74	
Cable section (Power)	mm ²	1.50 x 2 + EARTH	1.50 x 2 + EARTH	2.50 x 2 + EARTH	
Cable section (Interconnection)	mm ²	1.50 x 3 + EARTH	1.50 x 3 + EARTH	2.50 x 3 + EARTH	
Piping diameter (Liq / Gas)	Inch	1/4" / 3/8"	1/4" / 3/8"	1/4" / 1/2"	
Minimum piping length	m	3	3	3	
Maximum piping length / height difference	m	20 / 10	20 / 10	30 / 10	
Current quantity of refrigerant / Chargeless	kg	0.870	0.870	1.400	
Chargeless / Additional refrigerant charge	m / g/m	20/-	20/-	30/-	
Working range (cooling / heating)	°C	-10 ~ 43 / -15 ~ 21	-10 ~ 43 / -15 ~ 21	-10 ~ 43 / -15 ~ 21	
Refrigerant		R410A	R410A	R410A	
Condenser Fan		Propeller Fan			
Compressor	Type		Scroll	Scroll	Rotary
	Oil Type		poe	poe	HAF68D1U or equivalent
	Oil Charge	ml	380	380	440 ± 20
	Coil Resistance	Ω	1.2 at 20°C	1.2 at 20°C	1.69 at 20°C
	Quantity		1	1	1

NOTE:

- The Sound Pressure Level is based on the following conditions:
 - 1 meter from the unit front surface and 1 meter from floor level

The above data was measured in an anechoic chamber. Please take into consideration reflected sound of your specific site

2 DIMENSIONAL DATA

2.1. FLOOR TYPE: RAF-25RXB/35RXB/50RXB

Unit: mm

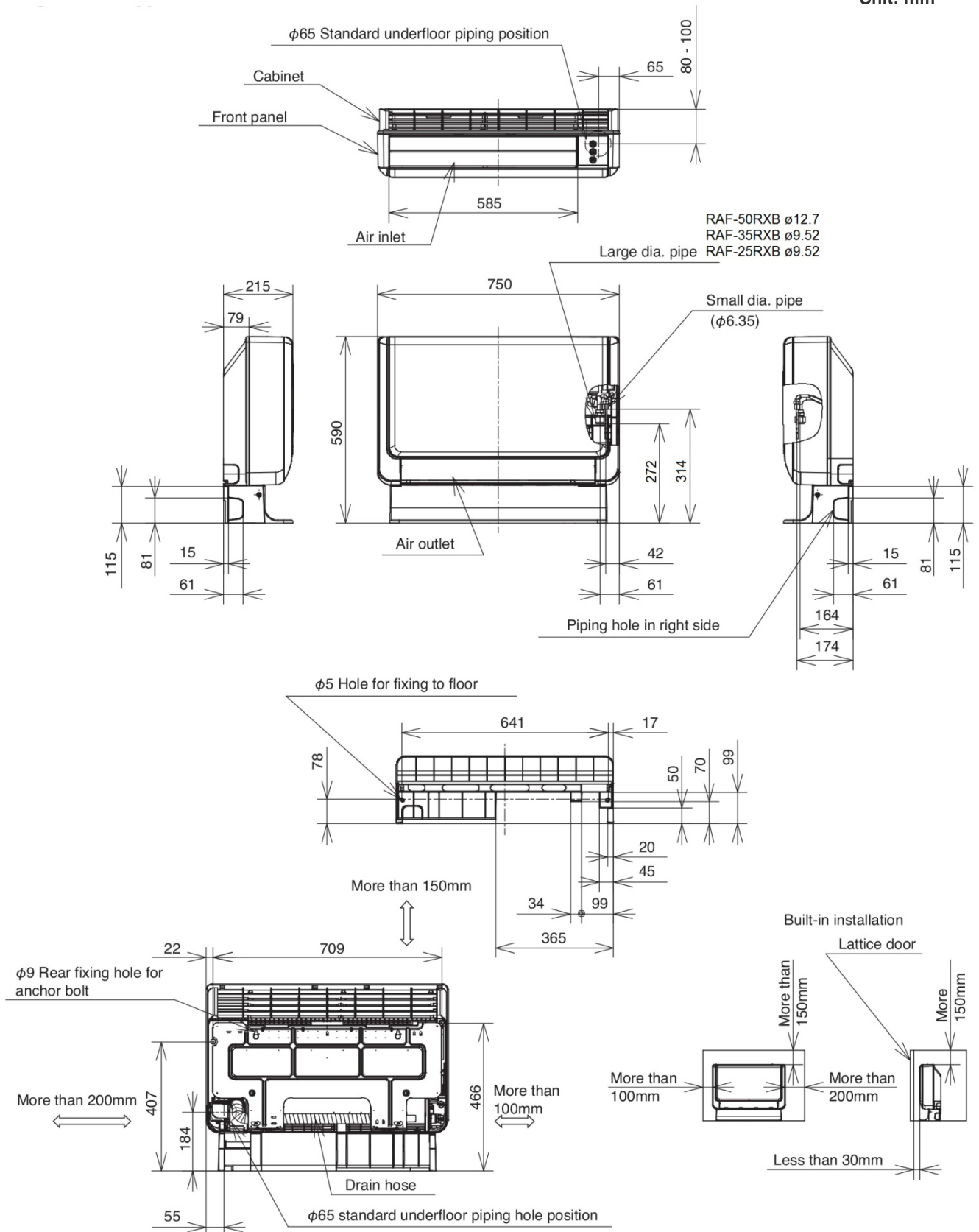

2.2. FLOOR TYPE: RAC-25FXB/35FXB

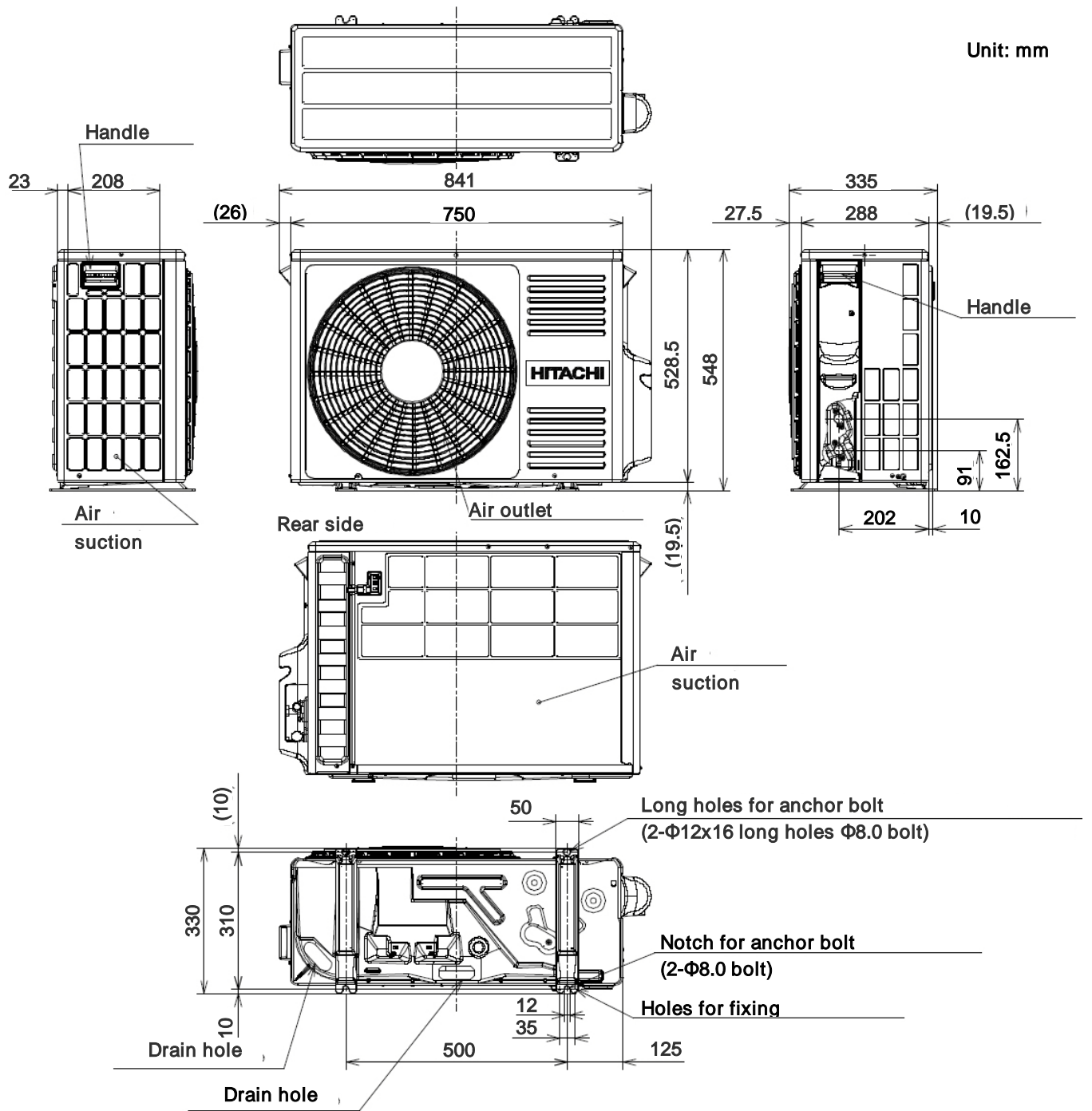

2.3. FLOOR TYPE: RAC-50FXB

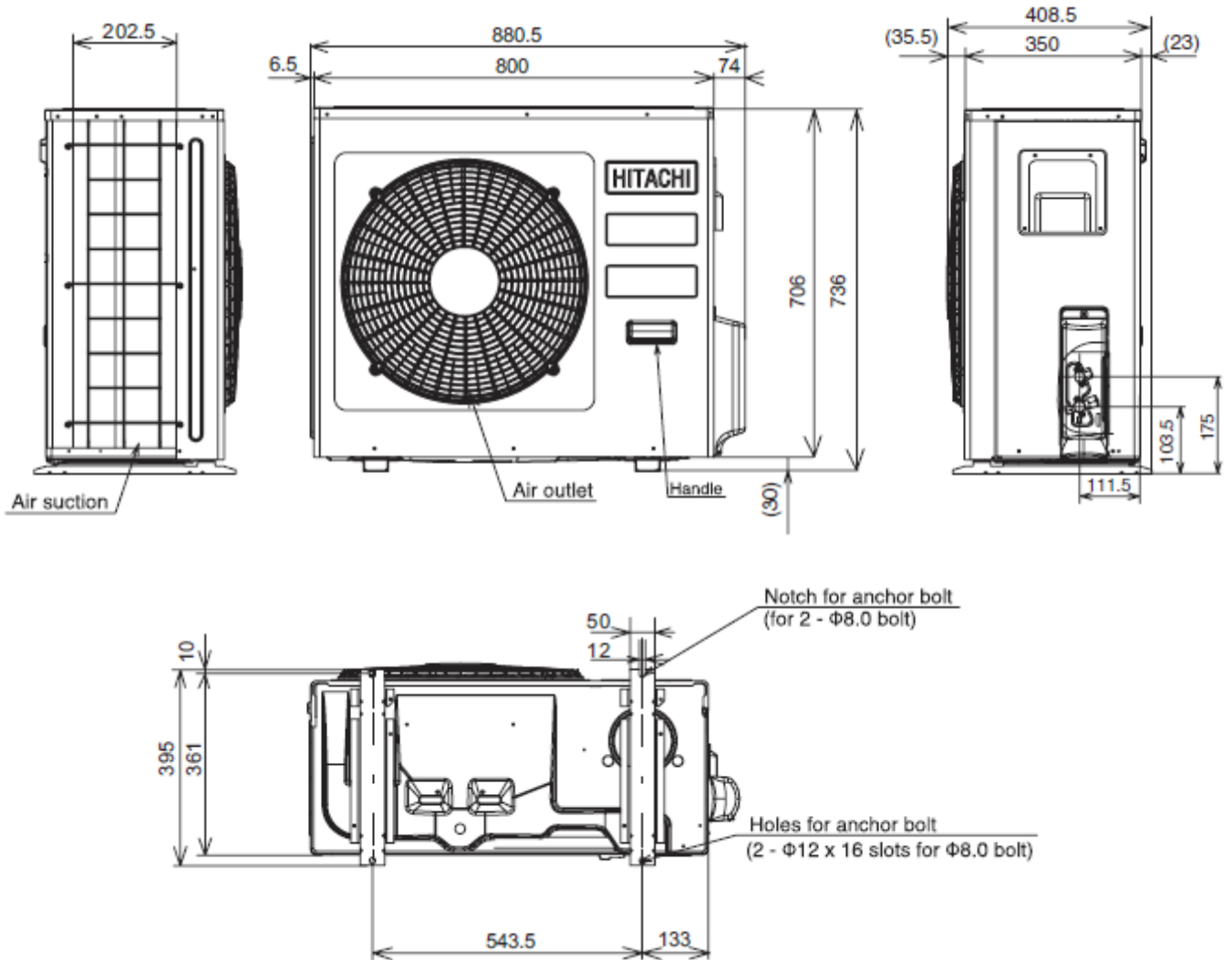

3 CAPACITIES TABLE

3.1. CAPACITY CHARACTERISTIC CURVES

The following charts show the characteristics of outdoor unit capacity, which corresponds with the operating ambient temperature of outdoor unit.

Condition:

① Pipe length / height difference : 5m / 0m

③ Capacity loss due to white frost and defrost operation is not included.

② Indoor fan speed at High mode

3.1.1. RAF-25RXB/RAC-25FXB

COOLING [50Hz, 230V]

INDOOR		OUTDOOR TEMPERATURE (°CDB)																				
EWB	EDB	-10			21			27			32			35			40			43		
		°C	°C	TC	SHC	PI	TC	SHC	PI	TC	SHC	PI	TC	SHC	PI	TC	SHC	PI	TC	SHC	PI	
12.0	18	1853	1706	308	2350	2548	410	2175	2352	483	2050	2230	534	1975	2132	557	1850	2009	597	1775	1911	621
14.0	20	1853	1706	308	2525	2548	410	2350	2377	489	2200	2230	539	2125	2156	563	1975	2009	603	1900	1936	632
16.0	22	1853	1816	313	2700	2548	415	2500	2377	495	2350	2230	545	2275	2156	574	2125	2009	615	2050	1936	638
18.0	25	1987	1947	318	2875	2769	421	2650	2573	500	2500	2426	551	2400	2328	574	2250	2181	621	2150	2083	644
19.0	27	2054	2013	323	2975	2916	426	2750	2695	506	2600	2548	557	2500	2450	580	2350	2303	621	2250	2205	644
22.0	30	2277	1991	323	3300	2891	426	3050	2671	506	2875	2524	563	2775	2426	586	2500	2352	644	2325	2303	679
24.0	32	2433	1991	327	3525	2891	432	3250	2671	512	3075	2524	563	2950	2426	592	2600	2401	661	2375	2377	702

HEATING [50Hz, 230V]

INDOOR		OUTDOOR TEMPERATURE (°CDB)																							
EDB	°C	-15			-10			-7			-5			0			7			10			15		
		TC	SHC	PI	TC	SHC	PI	TC	SHC	PI	TC	SHC	PI	TC	SHC	PI	TC	SHC	PI	TC	SHC	PI			
16	2766		1636	3329		1705	3657		1755	3608		1627	3496		1294	3361		852	3700		897	4237		973	
18	2783		1628	3346		1697	3679		1743	3632		1611	3523		1277	3380		821	3719		864	4269		937	
20	2800		1620	3363		1689	3700		1730	3657		1596	3550		1260	3400		790	3738		831	4300		900	
22	2817		1612	3380		1681	3721		1717	3682		1580	3577		1243	3420		759	3756		798	4331		863	
24	2834		1604	3397		1673	3743		1705	3706		1565	3604		1226	3439		728	3775		766	4363		827	

3.1.2. RAF-35RXB/RAC-35FXB

COOLING [50Hz, 230V]

INDOOR		OUTDOOR TEMPERATURE (°CDB)																				
EWB	EDB	-10			21			27			32			35			40			43		
		°C	°C	TC	SHC	PI	TC	SHC	PI	TC	SHC	PI	TC	SHC	PI	TC	SHC	PI	TC	SHC	PI	
12.0	18	2563	1996	536	2806	2572	615	2597	2375	725	2870	2639	938	2765	2523	979	2590	2378	1051	2485	2262	1091
14.0	20	2563	1996	536	3015	2572	615	2806	2399	733	3080	2639	949	2975	2552	989	2765	2378	1061	2660	2291	1112
16.0	22	2563	2124	544	3224	2572	623	2985	2399	742	3290	2639	959	3185	2552	1010	2975	2378	1081	2870	2291	1122
18.0	25	2749	2277	552	3433	2795	631	3164	2597	750	3500	2871	969	3360	2755	1010	3150	2581	1091	3010	2465	1132
19.0	27	2841	2354	561	3553	2944	639	3284	2721	759	3640	3016	979	3500	2900	1020	3290	2726	1091	3150	2610	1132
22.0	30	3150	2329	561	3941	2919	639	3642	2696	759	4025	2987	989	3885	2871	1030	3500	2784	1132	3255	2726	1193
24.0	32	3366	2329	569	4209	2919	647	3881	2696	767	4305	2987	989	4130	2871	1040	3640	2842	1163	3325	2813	1234

EWB : Evaporator Wet Bulb temperature (°C)

EDB : Evaporator Dry Bulb temperature (°C)

(°CDB) : Outdoor Unit Inlet Air Dry Temperature (°C)

TC : Total Capacity (W)

SHC : Sensible Heating Capacity (W)

PI : Power Input

HEATING [50Hz, 230V]

INDOOR		OUTDOOR TEMPERATURE (°CDB)																							
EDB		-15			-10			-7			-5			0			7			10			15		
°C	TC	SHC	PI	TC	SHC	PI	TC	SHC	PI	TC	SHC	PI	TC	SHC	PI	TC	SHC	PI	TC	SHC	PI	TC	SHC	PI	
16	3355		1674	4011		1737	4393		1789	4392		1722	4403		1537	4448		1316	4844		1359	5467		1433	
18	3378		1662	4034		1725	4422		1769	4425		1698	4439		1511	4474		1268	4869		1308	5508		1377	
20	3400		1650	4056		1713	4450		1750	4457		1674	4475		1485	4500		1220	4894		1258	5550		1320	
22	3423		1638	4079		1700	4478		1731	4490		1650	4511		1459	4526		1172	4919		1207	5592		1263	
24	3445		1626	4101		1688	4507		1711	4522		1626	4547		1433	4552		1124	4943		1156	5633		1207	

3.1.3. RAF-50RXB/RAC-50FXB**COOLING [50Hz, 230V]**

INDOOR		OUTDOOR TEMPERATURE (°CDB)																							
EWB		-10			21			27			32			35			40			43					
°C	°C	TC	SHC	PI	TC	SHC	PI	TC	SHC	PI	TC	SHC	PI	TC	SHC	PI	TC	SHC	PI	TC	SHC	PI	TC	SHC	PI
12.0	18	2621	1833	586	2672	2199	627	2473	2030	739	4100	3385	1435	3950	3236	1498	3700	3050	1607	3550	2902	1669			
14.0	20	2621	1833	586	2871	2199	627	2672	2051	747	4400	3385	1451	4250	3274	1513	3950	3050	1622	3800	2939	1700			
16.0	22	2621	1950	596	3069	2199	635	2842	2051	756	4700	3385	1466	4550	3274	1544	4250	3050	1654	4100	2939	1716			
18.0	25	2811	2091	605	3268	2389	643	3013	2220	765	5000	3683	1482	4800	3534	1544	4500	3311	1669	4300	3162	1732			
19.0	27	2905	2162	614	3382	2516	651	3126	2326	773	5200	3869	1498	5000	3720	1560	4700	3497	1669	4500	3348	1732			
22.0	30	3221	2138	614	3752	2495	651	3467	2305	773	5750	3832	1513	5550	3683	1576	5000	3571	1732	4650	3497	1825			
24.0	32	3442	2138	623	4007	2495	660	3695	2305	782	6150	3832	1513	5900	3683	1591	5200	3646	1778	4750	3608	1888			

HEATING [50Hz, 230V]

INDOOR		OUTDOOR TEMPERATURE (°CDB)																							
EDB		-15			-10			-7			-5			0			7			10			15		
°C	TC	SHC	PI	TC	SHC	PI	TC	SHC	PI	TC	SHC	PI	TC	SHC	PI	TC	SHC	PI	TC	SHC	PI	TC	SHC	PI	
16	3935		1716	4873		1903	5418		2036	5477		1996	5646		1866	5925		1740	6491		1860	7380		2066	
18	3968		1698	4905		1885	5459		2008	5524		1961	5698		1828	5963		1670	6527		1786	7440		1983	
20	4000		1680	4938		1868	5500		1980	5571		1926	5750		1790	6000		1600	6563		1713	7500		1900	
22	4033		1662	4970		1850	5541		1952	5619		1891	5802		1752	6037		1530	6598		1639	7560		1817	
24	4065		1644	5003		1832	5582		1924	5666		1855	5854		1714	6075		1460	6634		1565	7620		1734	

EWB : Evaporator Wet Bulb temperature (°C)
EDB : Evaporator Dry Bulb temperature (°C)
(°CDB) : Outdoor Unit Inlet Air Dry Temperature (°C)

TC : Total Capacity (W)
SHC : Sensible Heating Capacity (W)
PI : Power Input

3.2. CORRECTION FACTORS ACCORDING TO PIPING LENGTH

Correction Factor for **Cooling Capacity** according to Piping Length

The cooling capacity should be corrected according to the following formula:

$$CCA = CC \times F$$

- CCA: Actual Corrected Cooling Capacity (kcal/h)
- CC: Cooling Capacity in the Performance Table (kcal/h)
- F: Correction Factor Based on the Equivalent Piping Length

Correction Factor for **Heating Capacity** according to Piping Length

The heating capacity should be corrected according to the following formula:

$$HCA = HC \times F$$

- HCA: Actual Corrected Heating Capacity (kcal/h)
- HC: Heating Capacity in the Performance Table (kcal/h)
- F: Correction Factor Based on the Equivalent Piping Length

The correction factors are shown in the following figure.

Equivalent Piping Length for:

- One 90° Elbow is 0.5m.
- One 180° Curve is 1.5m.

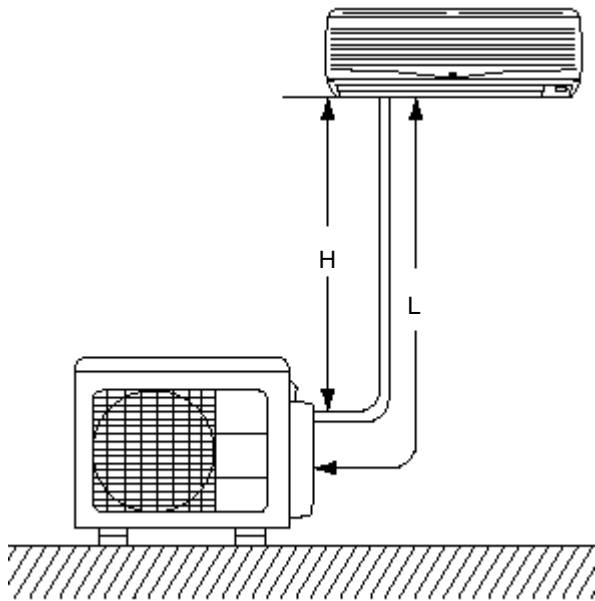

- H: Vertical Distance Between Indoor Unit and Outdoor Units in Meters
- L: Actual One-Way Piping Length Between Indoor Unit and Outdoor Unit in Meters
- EL: Equivalent Total Distance Between Indoor Unit and Outdoor Unit in Meters (Equivalent One-Way Piping Length)

Models : RAF-25RXB/RAC-25FXB

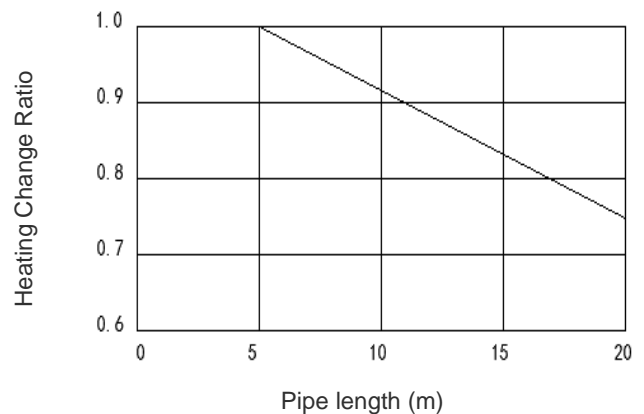
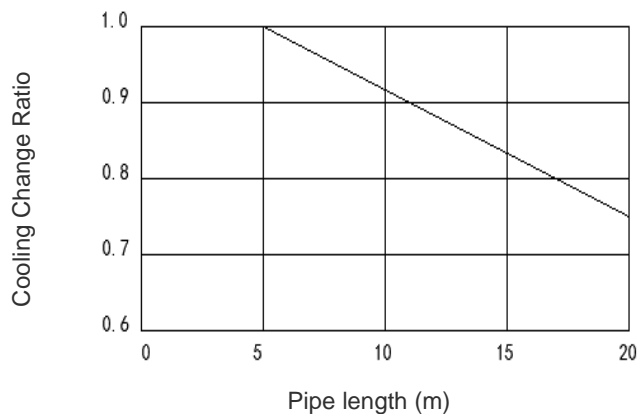

Models : RAF-35RXB/RAC-35FXB

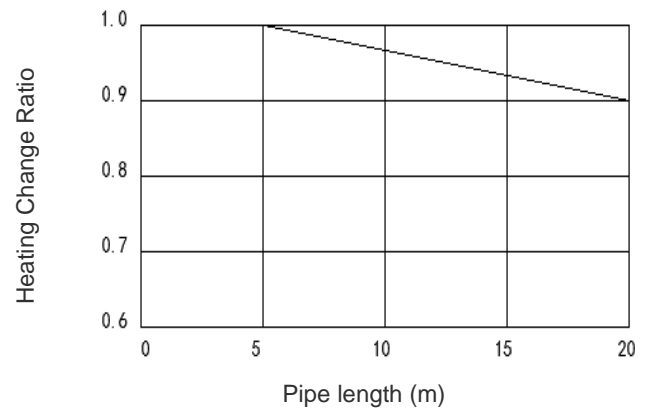
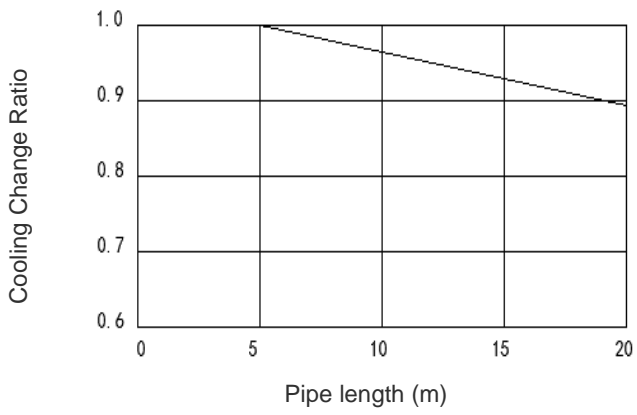

Models : RAF-50RXB/RAC-50FXB

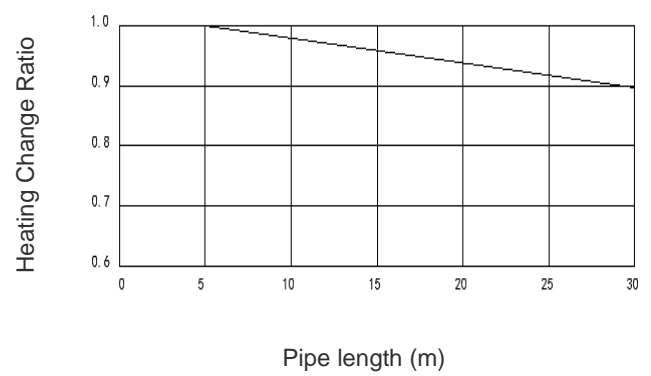
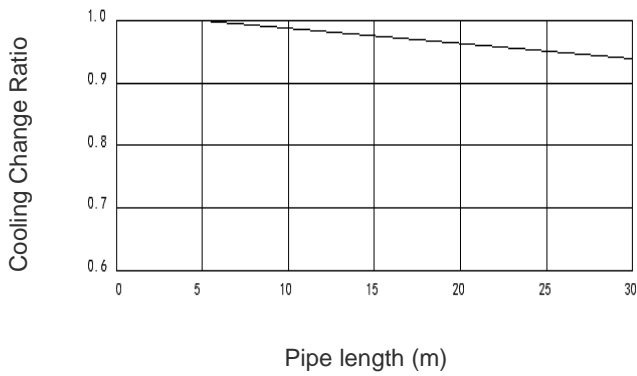

3.3. CORRECTION FACTORS ACCORDING TO DEFROSTING OPERATION

The heating capacity in the preceding paragraph, excludes the condition of the frost or the defrosting operation period. In consideration of the frost or the defrosting operation, the heating capacity is corrected by the equation below.

$$\text{Corrected heating capacity} = \text{Defrost Correction factor} \times \text{unit capacity}$$

OUTDOOR TEMPERATURE (°CDB)	-15	-10	-7	-5	0	7	10	15
Correction factor (humidity rate 85% RH)	0.95	0.95	0.89	0.85	0.81	1.0	1.0	1.0

Correction Factor

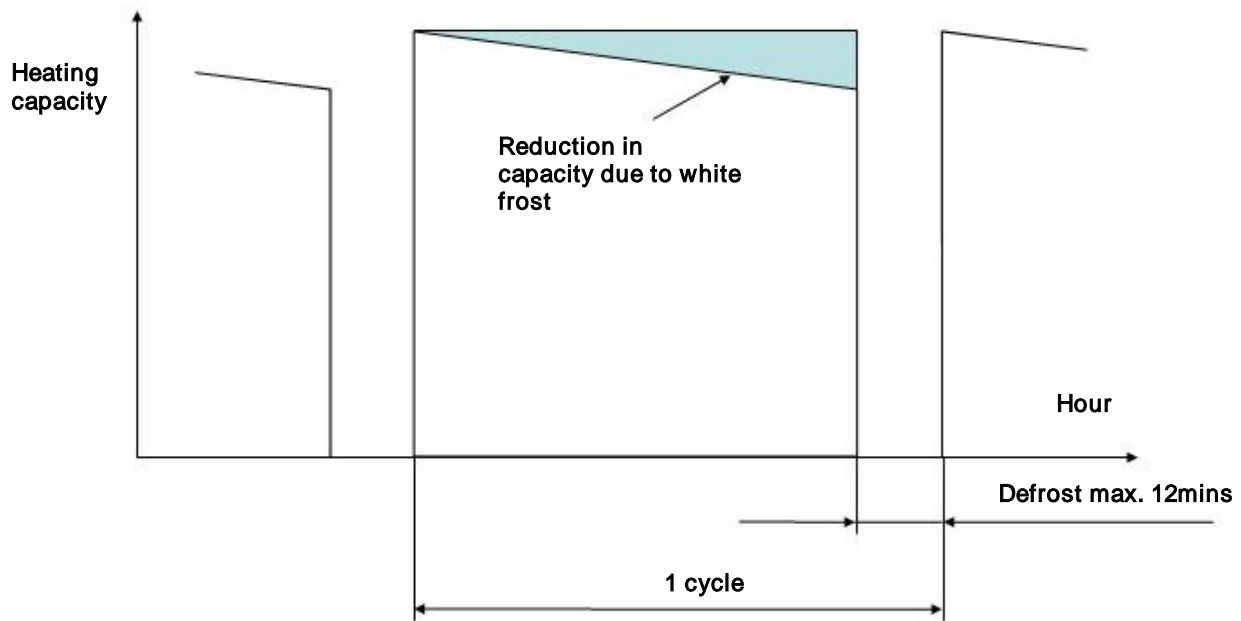

NOTE:

The correction factor is not valid for special conditions such as snowfall or operation in a transitional period.

4 SOUND DATA

4.1. RAC-25FXB

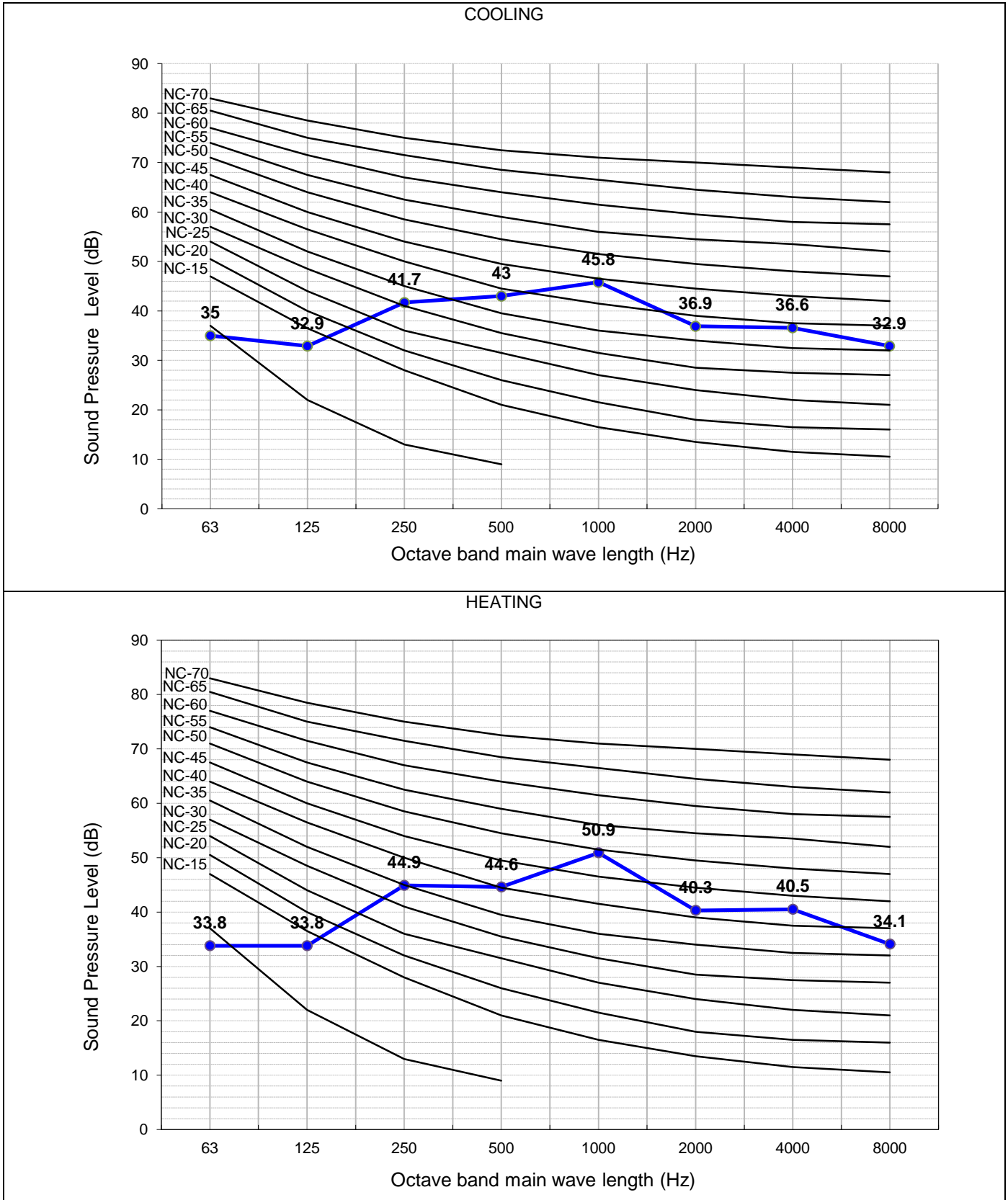

The Sound Pressure Level is based on the following conditions:

- 1 meter from the unit front surface and 1 meter from floor level

The above data was measured in an anechoic chamber. Please take into consideration reflected sound of your specific site

4.2. RAC-35FXB

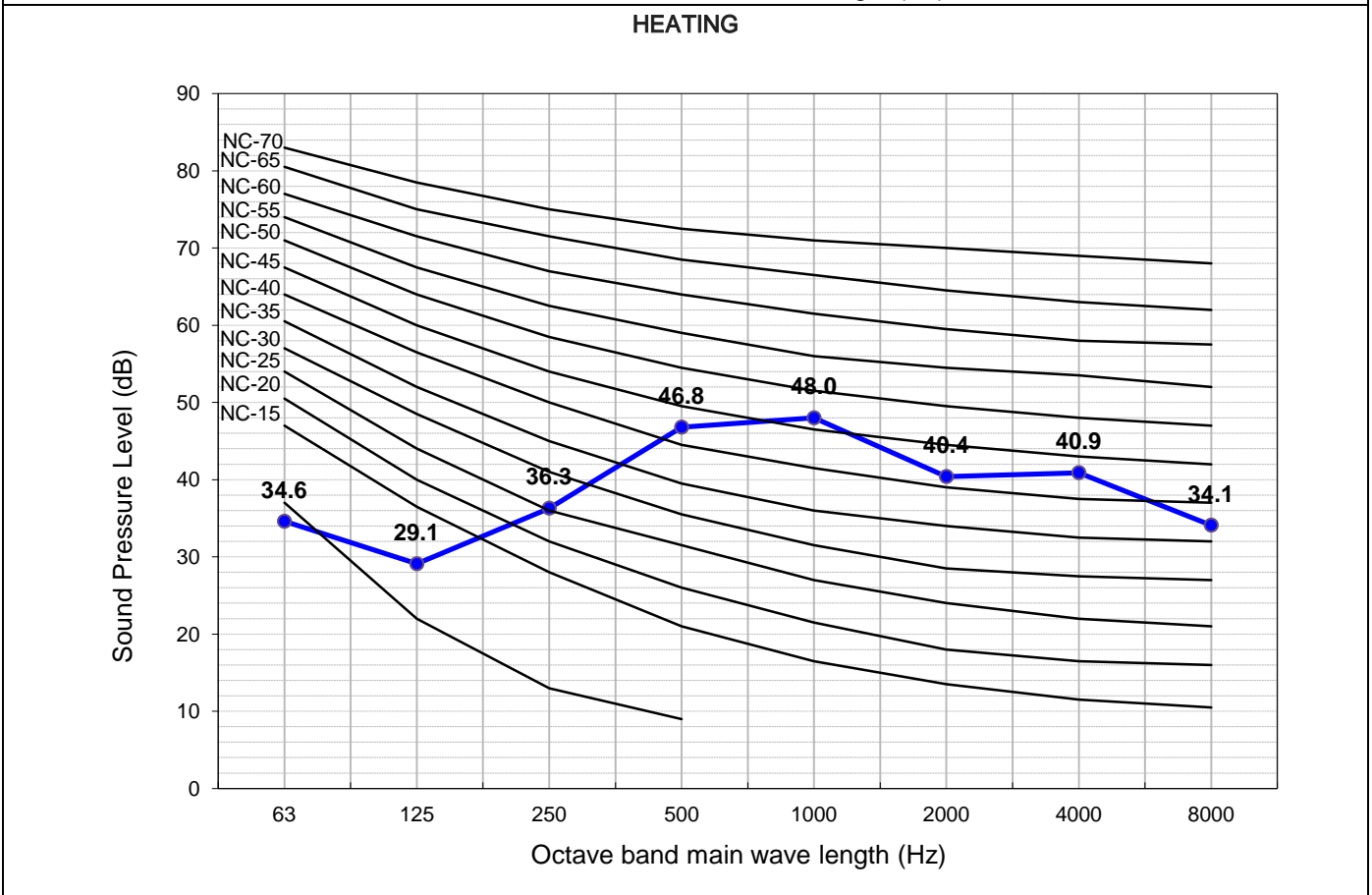
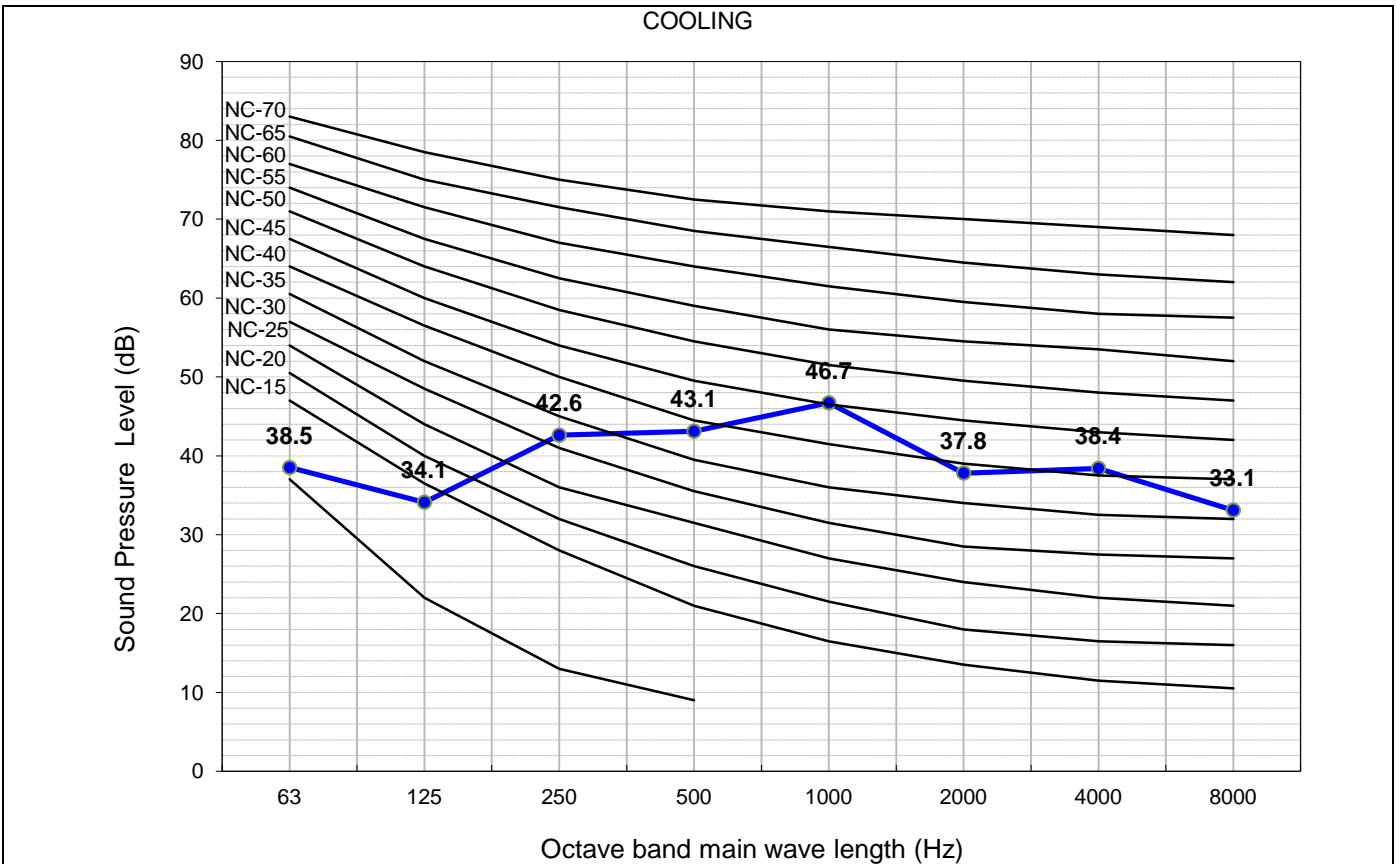

The Sound Pressure Level is based on the following conditions:

- 1 meter from the unit front surface and 1 meter from floor level

The above data was measured in an anechoic chamber. Please take into consideration reflected sound of your specific site

4.3. RAC-50FXB

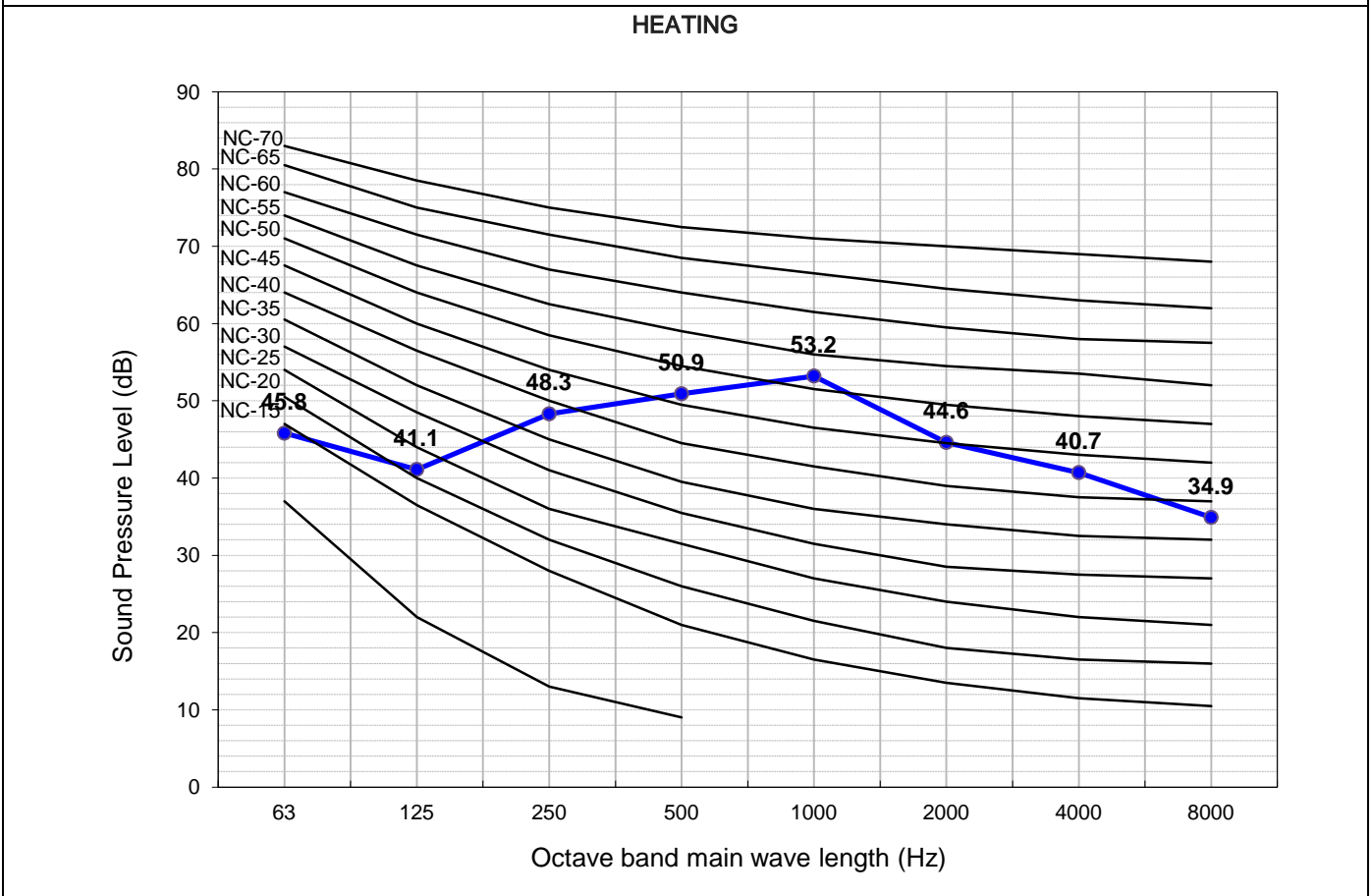
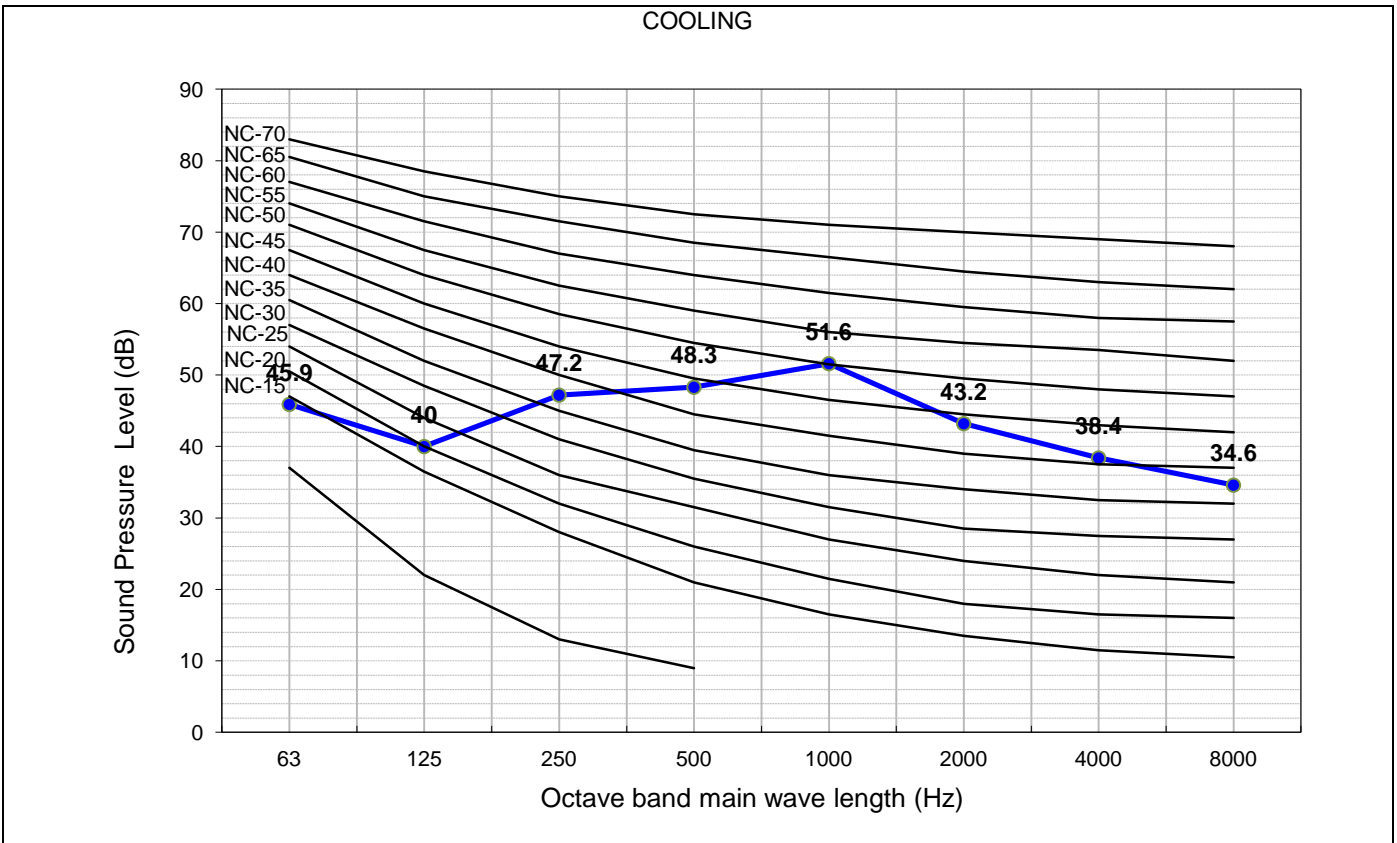

The Sound Pressure Level is based on the following conditions:

- 1 meter from the unit front surface and 1 meter from floor level

The above data was measured in an anechoic chamber. Please take into consideration reflected sound of your specific site

5 WORKING RANGE

5.1. POWER SUPPLY

Working Voltage	207V ~ 253V
Voltage Imbalance	Within a 3% Deviation from Each Voltage at the Main Terminal of Outdoor Unit
Starting Voltage	Higher than 85% of the Rated Voltage

5.2. WORKING RANGE

Applicable models:

RAC-25FXB
RAC-35FXB
RAC-50FXB

The temperature range is indicated in the following table.

Cooling

working range	min (°C)	max (°C)	rated (°C)
outdoor	-10	43	35
indoor	16	43	27

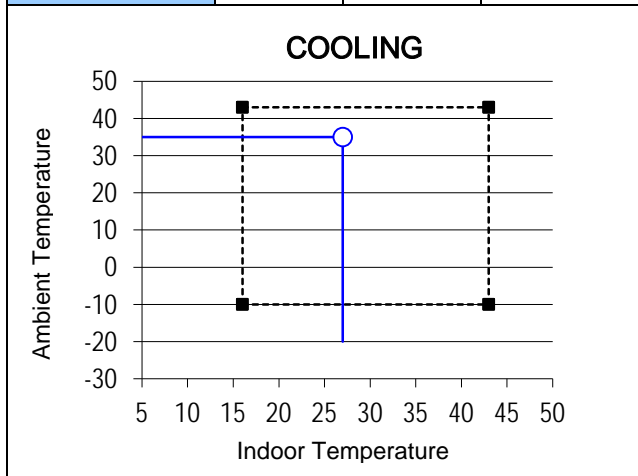

Heating

working range	min (°C)	max (°C)	rated (°C)
outdoor	-15	21	7
indoor	16	26	20

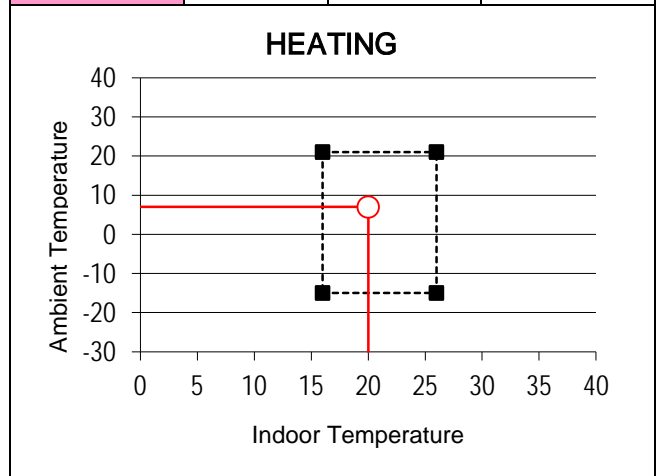

6 ELECTRICAL DATA

6.1. INDOOR UNIT

Model	Unit Main Power		Applicable Current		Indoor Fan Motor	
	VOL, PH, Hz	Fuse Rating (A)	STC	RNC	RNC	IPT
RAF-25RXB	230, 1, 50	3.15	(C) 3.31 (H) 4.24	(C) 5.13 (H) 4.87	0.75	38
RAF-35RXB	230, 1, 50	3.15	(C) 5.17 (H) 5.98	(C) 6.00 (H) 5.87	0.75	38
RAF-50RXB	230, 1, 50	3.15	(C) 7.11 (H) 8.10	(C) 9.13 (H) 11.74	0.75	38

VOL: Rated Unit Power Supply Voltage (V)
 Hz: Frequency (Hz)
 STC: Starting Current (A)

RNC: Running Current (A)
 PH: Phase (ϕ)
 IPT: Input (W)

6.2. OUTDOOR UNIT

Model	Unit Main Power				Compressor Motor					
	VOL, PH, Hz	Fuse Rating (A)	Min (V)	Max (V)	Locked Rotor Ampere (A)	STC	Cooling Operation		Heating Operation	
							RNC	IPT	RNC	IPT
RAC-25FXB	230, 1, 50	15	207	253	-	4.24	5.13	580	4.87	790
RAC-35FXB	230, 1, 50	15	207	253	-	5.98	6.00	1020	5.87	1220
RAC-50FXB	230, 1, 50	25	207	253	-	8.10	9.13	1560	11.74	1600

VOL: Rated Unit Power Supply Voltage (V)
 HZ: Frequency (Hz)
 STC: Starting Current (A)

RNC: Running Current (A)
 PH: Phase (ϕ)
 IPT: Input (W)

NOTE:

1. The above compressor data is based on 100% capacity combination of indoor units at the rated operating frequency
2. This data is based on the same conditions as the nominal heating and cooling capacities.
3. The compressor started by an inverter, resulting in extremely low starting current.

7 WIRING DIAGRAM

7.1. RAF-25RXB, RAF-35RXB, RAF-50RXB

BLK:BLACK GRN:GREEN
 RED:RED WHT:WHITE
 GRY:GRAY

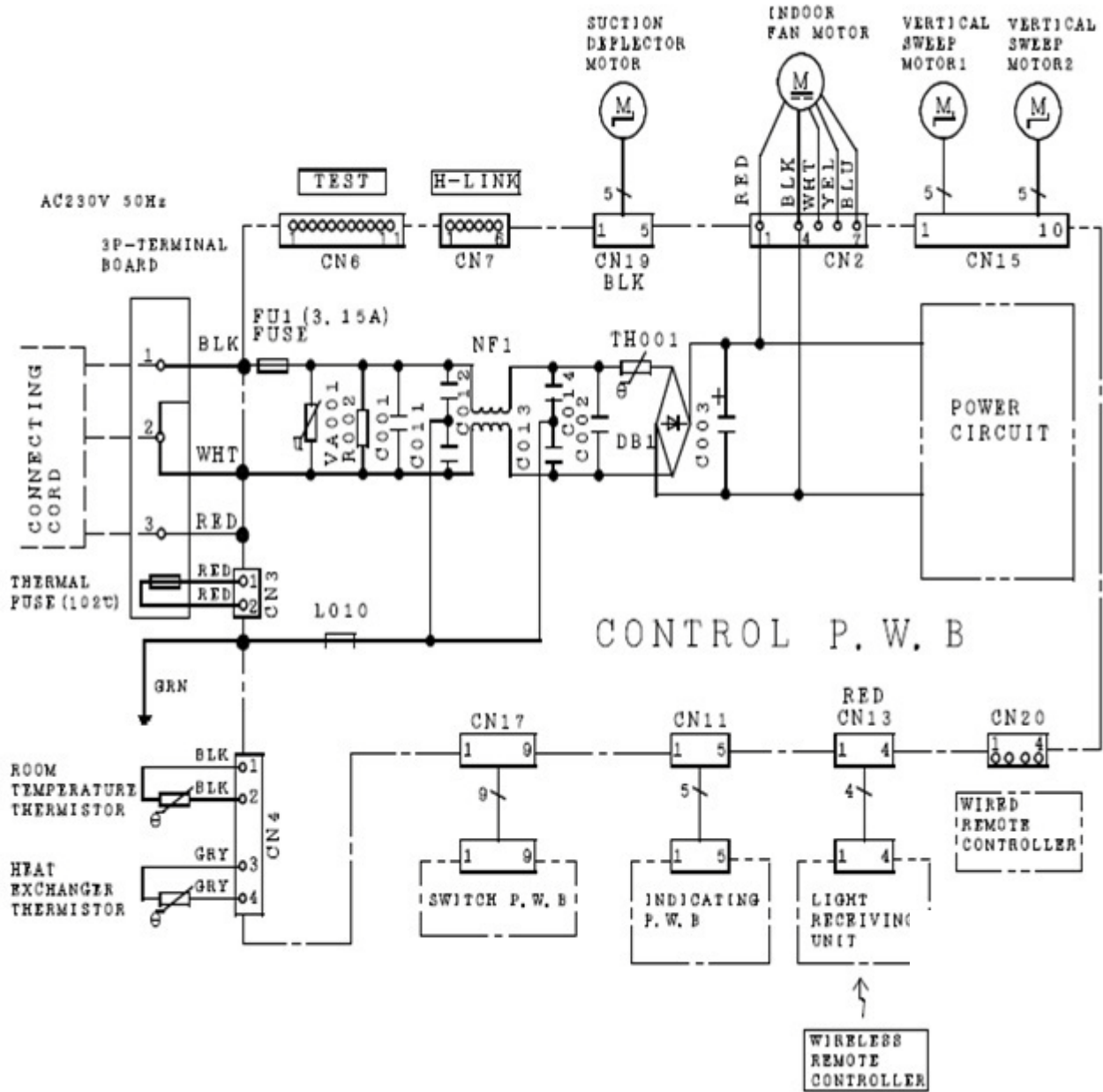

7.2. RAC-25FXB, RAC-35FXB

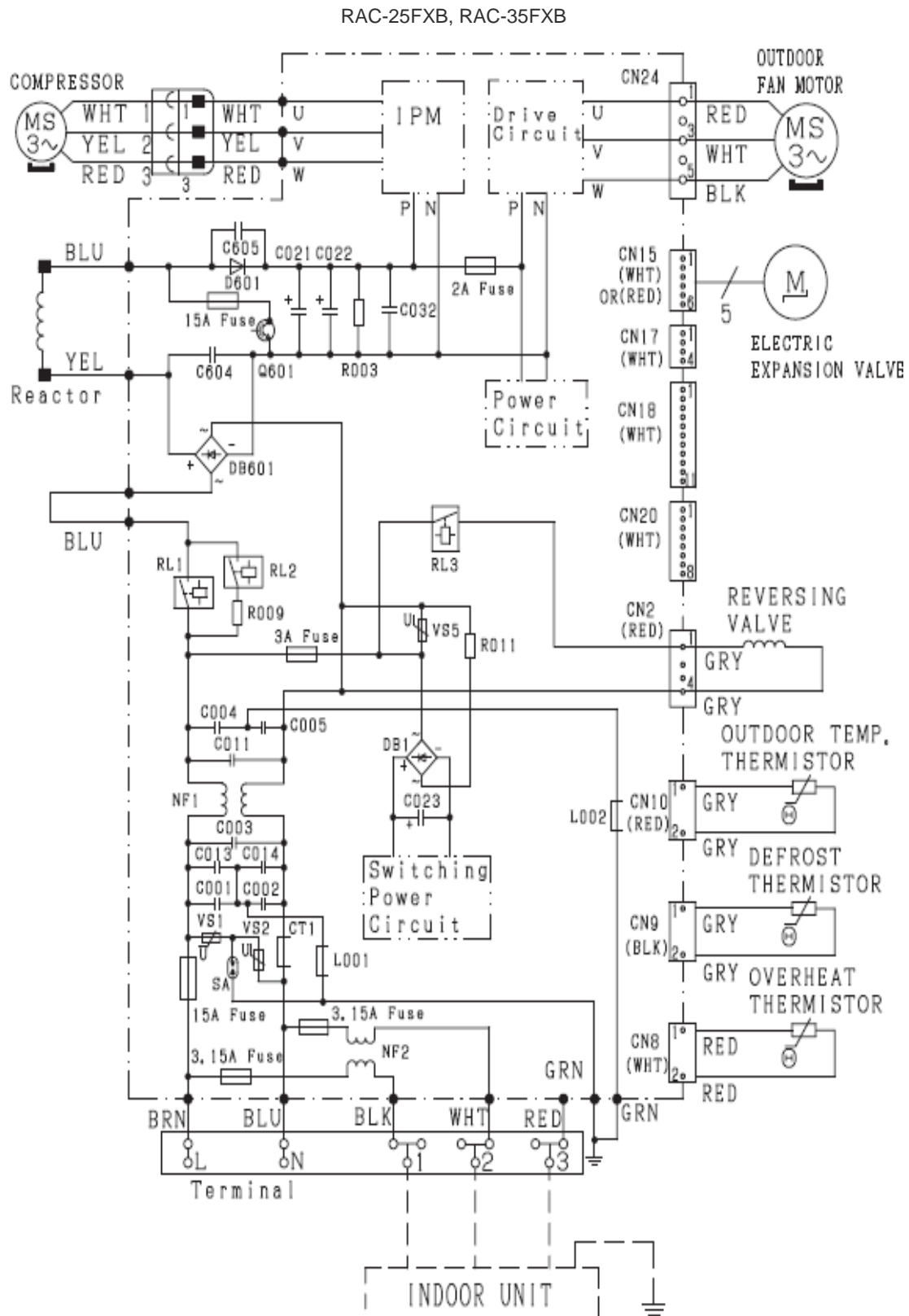

7.3. RAC-50FXB

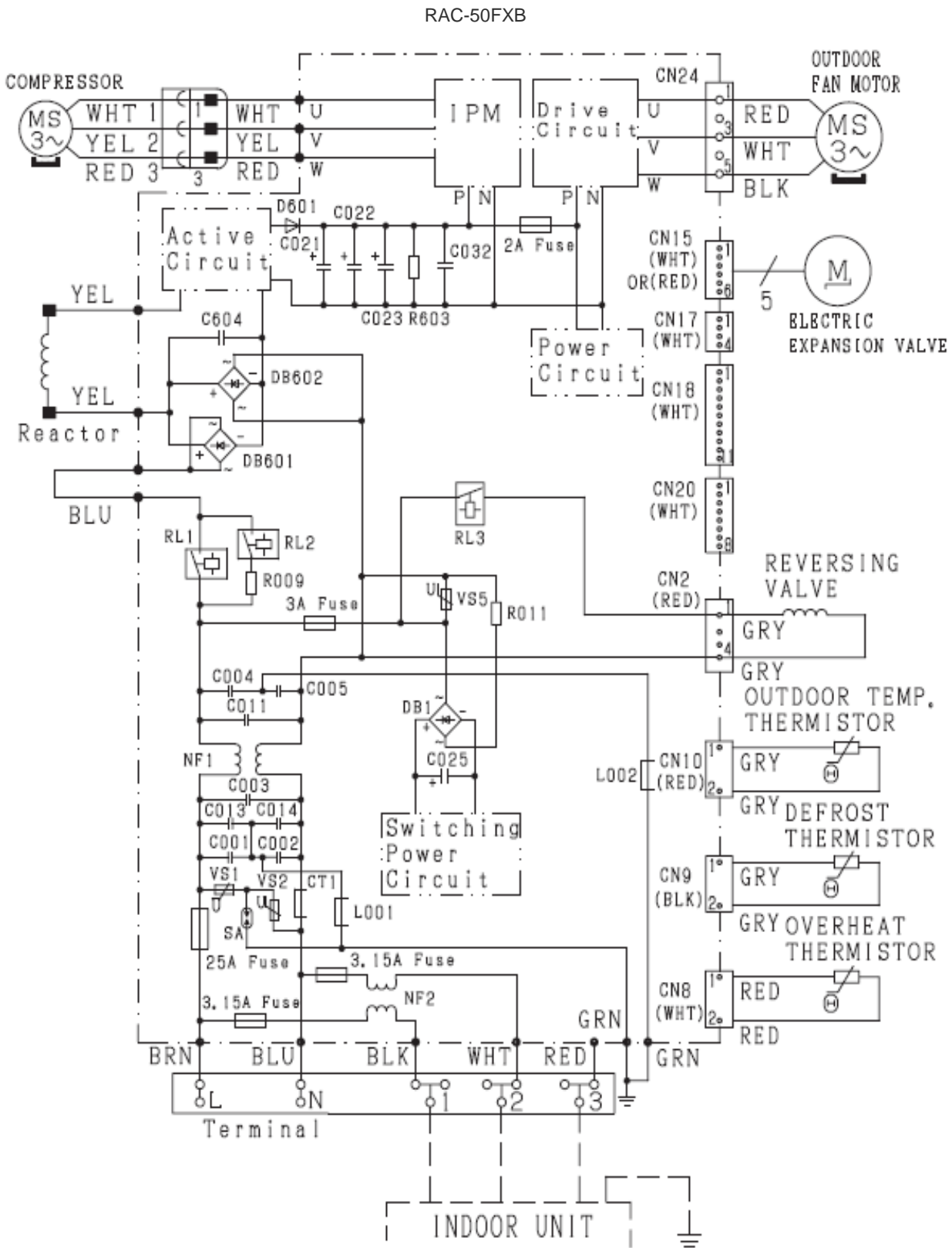

8 REFRIGERANT CYCLE

8.1. FLOOR TYPE: RAF-25RXB/RAC-25FXB, RAF-35RXB/RAC-35FXB

RAF-25RXB/RAC-25FXB, RAF-35RXB/RAC-35FXB

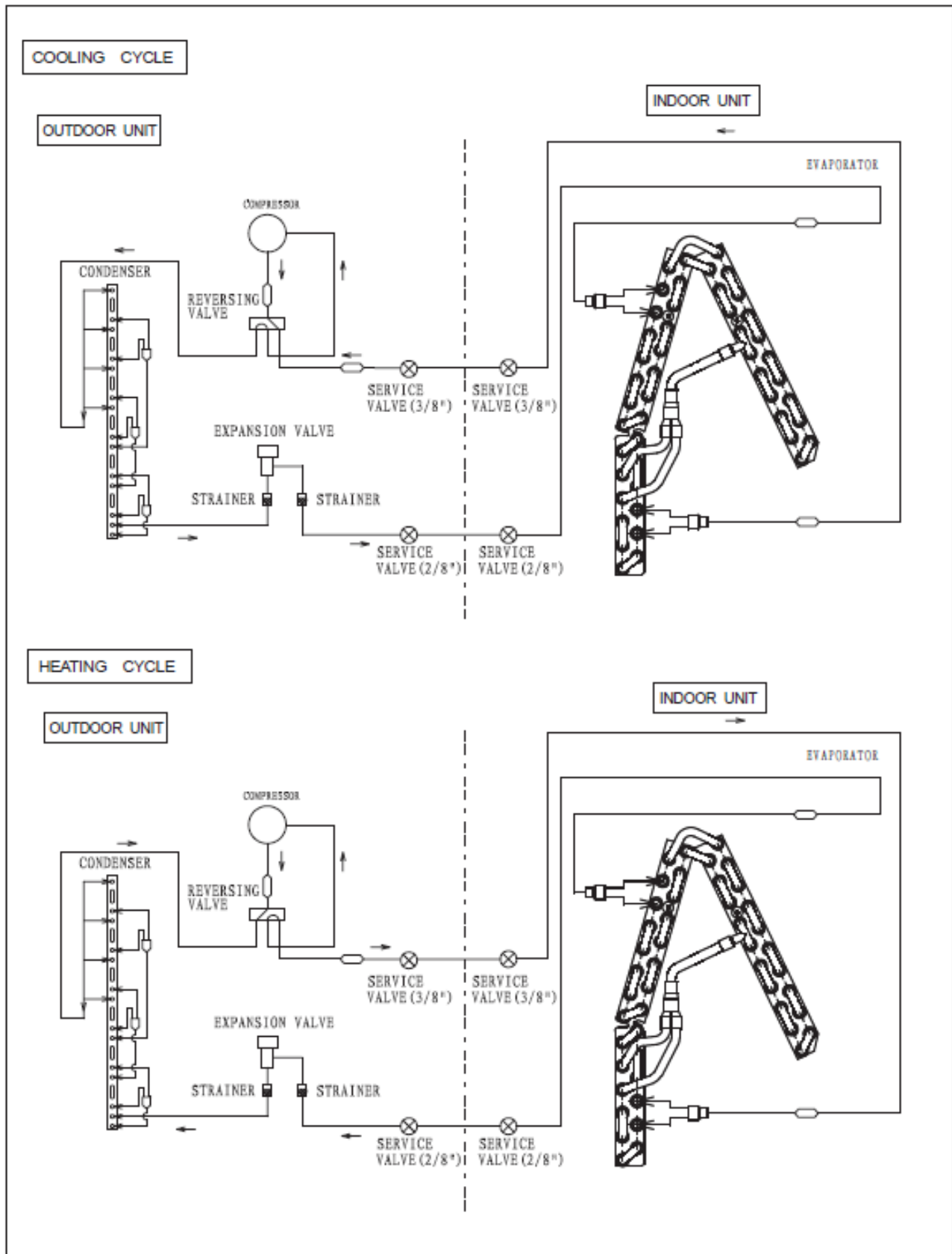

8.2. FLOOR TYPE: RAF-50RXB / RAC-50FXB

RAF-50RXB / RAC-50FXB

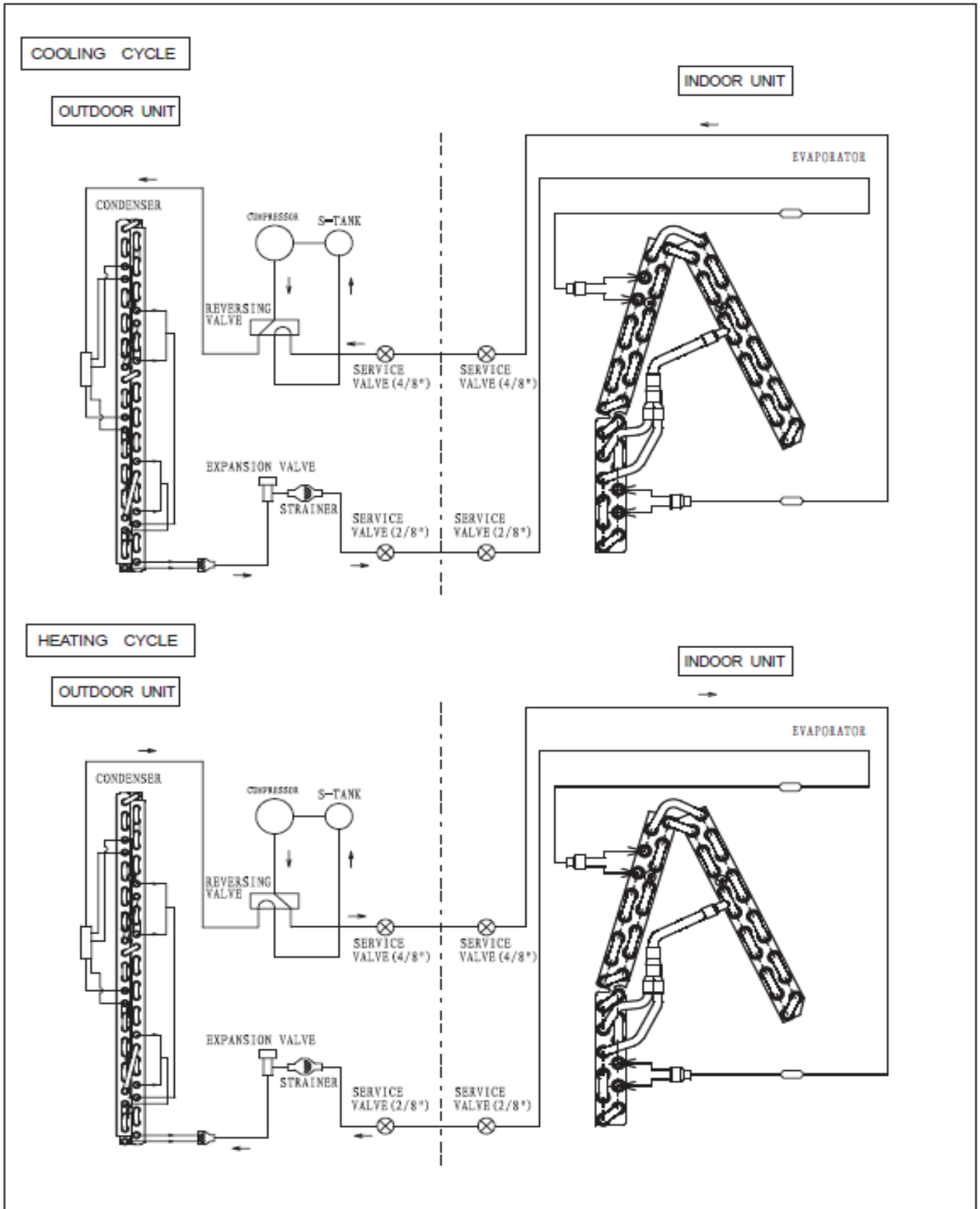

9 CONTROL AND FUNCTION

9.1. WIRELESS REMOTE CONTROL FUNCTION

BUTTONS	FUNCTION
	MODE Selector Use this button to select the operating mode. Every time you press this button, the mode will change from (AUTO) → (HEAT) → (DEHUMIDIFY) → (COOL) and → (FAN) cyclically.
	FAN SPEED Selector Button This determines the fan speed. Every time you press this button, the airflow rate will change from (AUTO) → (HIGH) → (MED) → (LOW) → (SILENT) (This button allows selection of optimal or preferred fan speed for each operation mode).
	START/STOP button Press this button to start operation. Press it again to stop operation.
	ECO button Use this button to set the ECO mode.
	POWERFUL button Use this button to set the POWERFUL mode.
	SILENT button Use this button to set the SILENT mode.
	INFO button 1) Press this button to display temperature for 10 seconds. 2) Press this button to check monthly power consumption. 3) Press this button to receive the current calendar and clock.
	ECO SLEEP TIMER button Use this button to set the ECO sleep timer.
	AUTO SWING (Vertical) button Controls the angle of the horizontal air deflector.
	EXTENDED AIR FLOW button Press this button during operation to start extended airflow operation.
	LEAVE HOME button Prevent the room temperature from falling too much by setting temperature 10°C~16°C when no one is at home.
	ONE TOUCH CLEAN button Drying indoor heat exchanger after cooling operation to prevent mildew.
WEEKLY TIMER buttons	
	ON/OFF TIMER button The device will turn on (off) and off (on) at the designated time.
	TIME button Press the button to set starting time of the program
	OK button Press the button to save the program. The button shall be pressed everytime after finishing a program setting.
	DELETE button 1) Press the button to delete the selected program. 2) Press the button for about 10 seconds by directing the remote controller towards the indoor unit while Mode A or B display blinks, programs for Mode A or B will be deleted both from the indoor unit and the remote controller after the beep sound from the indoor unit.
	DAY button Select the desired day of the week.
	PROGRAM NO. Button Press this button to select a program number.
	CANCEL 1) Press the button to cancel the current setting process on the screen. 2) Press the button by directing the remote controller towards the indoor unit, then weekly timer setting will be canceled from indoor unit after the beep sound from the indoor unit. The program setting remains in the remote controller.
	SEND button Press the button for about 3 seconds by directing the remote controller towards the indoor unit after finishing the program setting. Timer lamp on the indoor unit will blink rapidly and after the beep sound from indoor unit, TIMER lamp will light up.
	CLOCK button Press the button to set calendar and clock.
	WEEKLY TIMER MODE button 1) Select Mode A or Mode B. 2 modes can be set and stored as a weekly timer. 2) By pressing the button longer than 3 seconds, program setting screen will appear.



RAR-6N4

9.2. AUTO CHANGEOVER

COOLING/HEATING mode is decided by the room temperature.

- A. COOLING/HEATING mode is decided during the **initial startup** of Automatic Operation
 Initial startup of Automatic Operation means the following either condition:
- Unit start up in Automatic Operation
 - Automatic Operation mode is pressed while the unit is running in manual mode

Startup room temperature	COOL / HEAT
>= Remote controller setting temperature	Unit runs in COOLING mode
< Remote controller setting temperature	Unit runs in HEATING mode

- B. COOLING/HEATING mode is decided in **intervals after the initial startup** of Automatic Operation (also known as Auto Changeover function)

Intervals	Duration
1 st interval	10 minutes
2 nd interval	15 minutes
Subsequent interval	Every 55 minutes

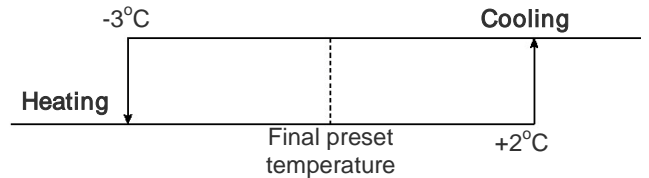

9.3. SHIFT VALUE

1. Press and hold (START/STOP) button and (ON) button.
2. Press [RESET] button on the same time. Release [RESET] button only, then release (START/STOP) and (ON) button once Screen 1 appears.



Screen 1



Screen 2

3. Press the (MODE) button to display fan mode (Screen 3).

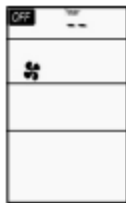

Screen 3

4. Press (START/STOP) and Screen 4 appear.

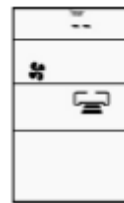

Screen 4

5. Select (FAN SPEED) button to choose Heating Shift or Cooling Shift Mode (Screen 5).

By setting fan speed to HIGH or MED, it will go to Cooling Shift mode.
 By setting fan speed to LOW or SILENT, it will go to Heating Shift mode.

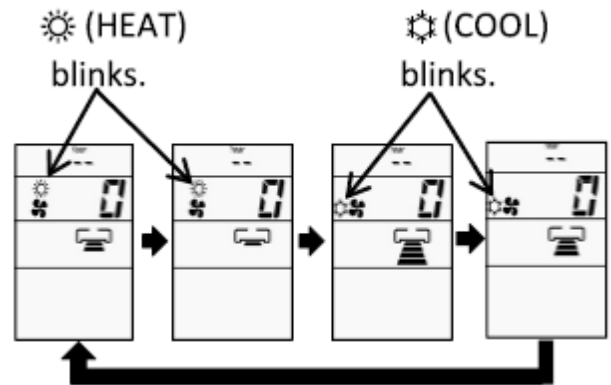

Screen 5

6. Press the Temperature button (or) to adjust the shift value.

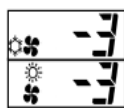

Decrease 3°C from the initial shift value setting.

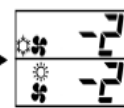

Decrease 2°C from the initial shift value setting.

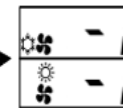

Decrease 1°C from the initial shift value setting.

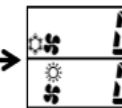

The initial shift value setting.



Increase 1°C from the initial shift value setting.



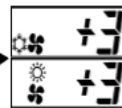

Increase 2°C from the initial shift value setting.









Increase 3°C from the initial shift value setting.

NOTE:

1. There are total of 7 shift values ranging from -3 to 3.
2. The displayed shift value,  (HEAT) and  (COOL) symbol on the remote controller display will be disappear after 10 seconds
3. The changed shift value will remain unchanged after turned off the power.
4. If "0" is displayed on the remote controller display, it indicates the shift value is now at the initial setting.

9.4. OPERATION LOCK

1. HEATING MODE

- a) Press and hold  (ECO) and  (POWERFUL) buttons, press  (RESET) button on the same time. Release  (RESET) button only when Screen 1 appear, then release  (ECO) button and  (POWERFUL) button.



Screen 1



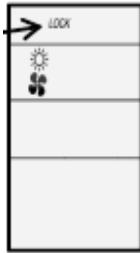

- b) Wait until only Screen 2 appear.





Screen 2

- c) The heating mode operation is locked.
d) To unlock HEATING mode, repeat step (a). After all operations mode symbols displayed for 10 seconds, the operation mode symbol before cancellation will be display. The heating mode operation is unlocked.

2. COOLING AND DEHUMIDIFYING MODE

- a) Press and hold  (ECO) and  (SILENT) buttons for at least 5 seconds when the remote controller is OFF.
b) Wait until only  and  displayed on the screen. The cooling and dehumidifying modes operation is locked.
c) To unlock HEATING mode, repeat step (a). After all operations mode symbols displayed for 10 seconds, the operation mode symbol before cancellation will be display. The cooling and dehumidifying mode operation is unlocked.

9.5. SETTING THE PREVENTION OF MUTUAL INTERFERENCE

1. Please ensure the other indoor unit is OFF.
2. Press  (PROGRAM NO.) button,  (ON TIMER) button and  (RESET) button simultaneously. The remote controller will display Screen 1 and followed by Screen 2. The indoor unit beeps to indicate that it has just received the signal from remote controller.



Screen 1



Screen 2







NOTE:

1. If indoor unit still not receive the correct signal from the correct remote controller, setting shall be made again. By setting again for the 2nd time, the signal address will change from B to A, then repeat again for the 3rd time.

9.6. INTERMITTENT FAN SPEED SETTING

The intermittent fan control during thermo off in Heating Mode can be changed by the remote controller. (This procedure should be done only by service personnel.) It is possible to select from 3 patterns.

PROCEDURE

1. Press  [START/STOP] button,  [Mon-Sun] button and press  [RESET] button simultaneously. Release  [RESET] button only and make sure that all marks on the remote controller display are indicated, then release  [START/STOP] button and  [Mon-Sun] button. Remote controller now enters "Intermittent Fan Control Change Mode".

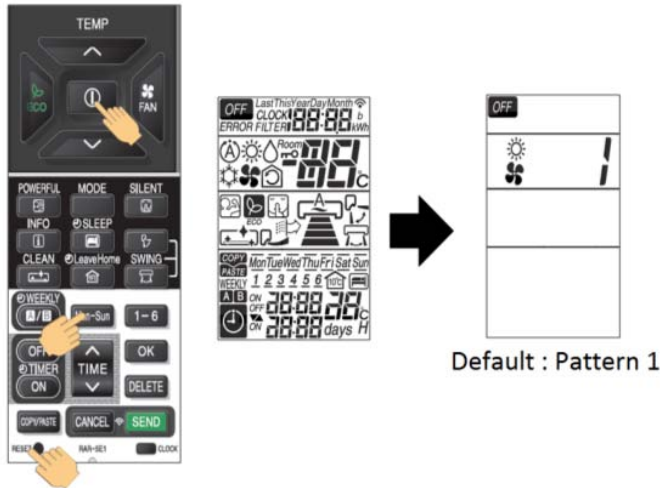

2. Press [ROOM TEMPERATURE setting] [\wedge (UP)]/[\vee (DOWN)] buttons. (The intermittent pattern changed with indoor unit beep sound.)

Transmission sign lights up with beep from indoor unit simultaneously.

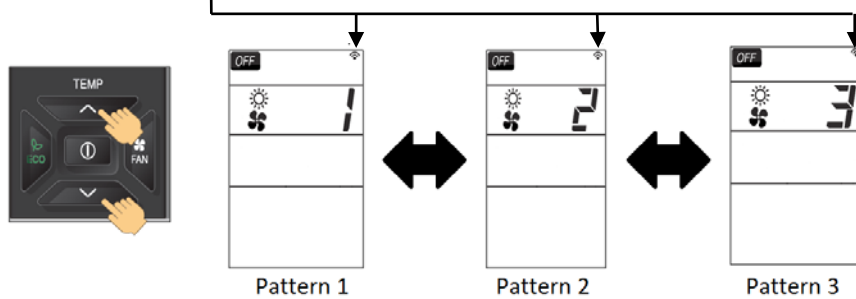

	Pattern 1	Pattern 2	Pattern 3
Single Model	Continuous	30sec ON / 210sec OFF repeatedly	50sec ON / 190sec OFF repeatedly
Multi Model	30sec ON / 210sec OFF repeatedly	50sec ON / 190sec OFF repeatedly	Continuous



NOTE :

- (1) The indication of the selected intermittent pattern will disappear after 10 seconds.
- (2) The selected intermittent pattern will remain unchanged after the unit is turned off.

9.7. FAN SPEED SETTING IN THERMO OFF IN COOLING

The fan speed in Cooling Mode during thermo off can be changed by the remote controller.
(This procedure shall be implemented strictly by service personnel only.)
It is possible to return it to the default setting.

PROCEDURE

Press  [POWERFUL] button and  [TIME ^ (UP)] button simultaneously for about 5 seconds when the remote controller is OFF.

Transmission sign lights up with beep from indoor unit simultaneously.

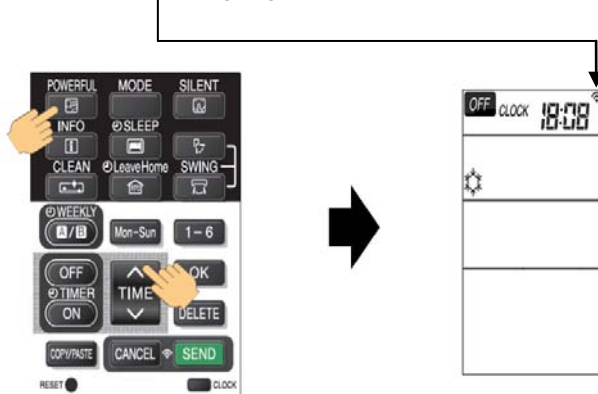



Beep sound pattern :
 1) Default setting : Short beep
 2) Changed setting : Double beep

	Fan speed during thermo off
Default Setting	Ultra low
Changed Setting	Set fan speed (When auto fan speed is set, the fan speed is low)

NOTE :

- (1) The selected fan speed will remain unchanged after the unit is turned off.
- (2) If Timer reservation has been set, it will be canceled.
- (3) During time setting and timer setting, this operation cannot be set.

9.8. ERROR CODE INFORMATION

1. In case failure occurs to the air conditioner, by pressing  (INFO) button, an error code will be displayed.
2. Direct the remote controller towards the receiver of indoor unit (within 2 meters in from of indoor unit) and press  (INFO) button.
3. Wait for 2 seconds for signal transmission and the error code will be displayed.

	TIMER LAMP BLINKING	LED301 BLINKING	CODE	MEANING
INDOOR	-	-	000 00	Normal
	1 time	-	001 00	Refrigerant cycle fault
	2 times	-	-	Outdoor unit is under forced operation
	3 times	9 times	003 00	Communication error between indoor and outdoor units
	9 times	-	009 00	Indoor thermistor
	10 times	-	010 00	Abnormal rotating numbers
	13 times	-	013 00	IC401 data reading error
OUTDOOR	4 times	2 times	002 01	Peak current cut
	4 times	3 times	003 01	Compressor abnormal low speed rotation
	4 times	4 times	004 01	Compressor switching failure
	4 times	5 times	005 01	Overload lower limit cut
	4 times	6 times	006 01	OH thermistor temperature rise
	4 times	7 times	007 01	Abnormal outdoor thermistor
	4 times	8 times	008 01	Acceleration defective
	4 times	9 times	009 01	Communication error
	4 times	10 times	010 01	Abnormal power source
	4 times	11 times	011 01	Fan stop for strong wind
	4 times	12 times	012 01	Fan motor fault
	4 times	13 times	013 01	EEPROM reading error
	4 times	14 times	014 01	Active converter defective
4 times	15 times	015 01	Abnormal PWB circuit	

	TIMER LAMP BLINKING	LD301 Lit LD302 BLINKING	CODE	MEANING
OUTDOOR	4 times	1 times	071 01	Overheat thermostat
	4 times	2 times	072 01	Defrost thermostat
	4 times	3 times	073 01	Outdoor temperature thermostat
	4 times	4 times	074 01	Narrow pipe thermostat (indoor 1)
	4 times	5 times	075 01	Wide pipe thermostat (indoor 1)
	4 times	6 times	076 01	Narrow pipe thermostat (indoor 2)
	4 times	7 times	077 01	Wide pipe thermostat (indoor 2)
	4 times	8 times	078 01	Narrow pipe thermostat (indoor 3)
	4 times	9 times	079 01	Wide pipe thermostat (indoor 3)
	4 times	10 times	080 01	Narrow pipe thermostat (indoor 4)
	4 times	11 times	081 01	Wide pipe thermostat (indoor 4)
	4 times	12 times	082 01	Narrow pipe thermostat (indoor 5)
	4 times	13 times	083 01	Wide pipe thermostat (indoor 5)

9.9. ADDITIONAL FUNCTION VIA DIP-SWITCH SETTINGS

A new DIP Switch is available on the PWBs of the indoor unit that provide additional functions via the settings on the switches.

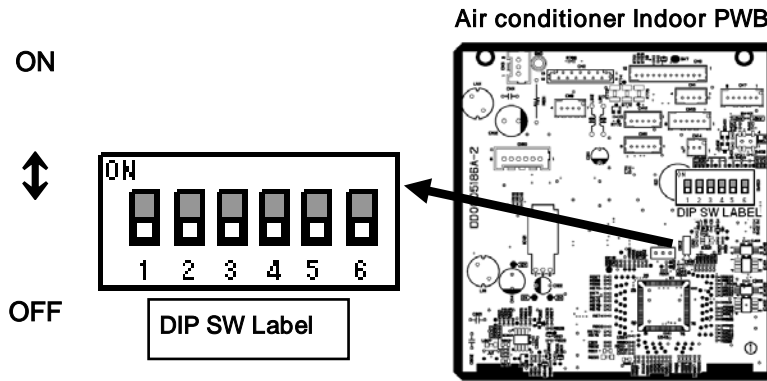

Pin No.	Function	Switch Position / Setting					
		OFF	Enable	ON	Disable		
1	AUTO RESTART function	OFF	Enable	ON	Disable		
2	DRY CONTACT function	OFF	Disable	ON	Enable		
3	DRY CONTACT Logic Select	OFF	HI Input Active	ON	LO Input Active		
4	HEATING / COOLING ONLY MODE SELECT	OFF	NORMAL (HEAT AND COOL)	OFF	HEATING ONLY	ON	COOLING ONLY
5		OFF		ON		OFF	
6	REMOCON ID SELECT ❖1	OFF	SELECT ID A	ON	SELECT ID B		

NOTE:

- ❖1 The setting of pin no. 6 is disabled for this model. Please refer to 9.5 SETTING THE PREVENTION OF MUTUAL INTERFERENCE.

9.9.1. AUTO RESTART FUNCTION

The AUTO RESTART function can be enabled or disabled by setting Pin No. 1 on the DIP SWITCH above to the ON or OFF position accordingly.











9.9.2. HEATING/COOLING ONLY MODEL SELECTION

When this function is enabled, the operation mode could be locked to either Heating Only (Heating or Fan) or Cooling Only (Cooling, Fan or Dehumidifying) by setting the Pin No. 4 and 5 accordingly.

LOCKED MODE	REMARKS
HEATING ONLY	Unit will not enter into Cooling mode although cooling mode is selected using the remote controller.
COOLING ONLY	Unit will not enter into Heating mode although heating mode is selected using the remote controller.

10 OPTION LIST

10.1. WIRED REMOTE CONTROL – SPX-RCDB

 <p>RAR-5G2 (SPX-RCDB)</p>	BUTTONS	FUNCTION
		MODE Selector Use this button to select the operating mode. Every time you press this button, the mode will change from (A) (AUTO) → (H) (HEAT) → (D) (DEHUMIDIFY) → (C) (COOL) and → (F) (FAN) cyclically.
		FAN SPEED Selector Button This determines the fan speed. Every time you press this button, the airflow rate will change from (A) (AUTO) → (H) (HIGH) → (M) (MED) → (L) (LOW) → (S) (SILENT) (This button allows selection of optimal or preferred fan speed for each operation mode).
		ON/OFF button Press this button to start operation. Press it again to stop operation.
		SLEEP button Use this button to set the SLEEP timer.
		SET button Timer setting reservation.
		OFF button Select the turn OFF timer.
		ON button Select the turn ON timer.
		CANCEL button Cancel timer reservation.
		AUTO SWING (Vertical) button Controls the angle of the horizontal air deflector.
	ROOM TEMPERATURE setting button Value will change quicke when keep pressing.	

10.1.1. SHIFT VALUE

1. Press and hold (ON/OFF) button and (ON TIMER) button at the same time while giving a single press on the RESET button until remote controller now enter 'Shift value change mode'.
2. Press (ON/OFF) button so that the display indicates (FAN) (FAN) speed.
3. Select (FAN SPEED) button to choose Heating Shift or Cooling Shift Mode.

By setting fan speed to HIGH (H) or MED (M), it will go to Cooling Shift mode.

By setting fan speed to LOW (L) or SILENT (S), it will go to Heating Shift mode.



4. Press (ROOM TEMPERATURE) button to change the shift value (-3°C ~ 0 ~ 3°C).
5. Press (ON/OFF) button to end 'Shift value setting mode'.



NOTE:

1. There are total of 7 shift values ranging from -3 to 3.
2. The changed shift value will remain unchanged after turned off the power.

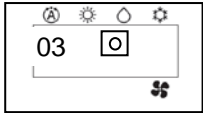
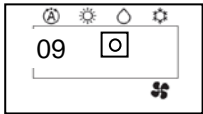
10.1.2. ERROR CODE INFORMATION

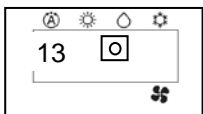
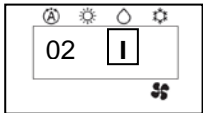
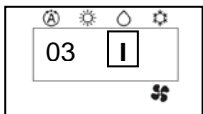
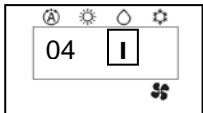
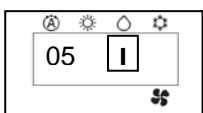
- In case failure occurs to the air conditioner, the error code will constantly appear on the wired remote controller display.

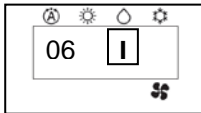
	TIMER LAMP BLINKING	LD301 BLINKING	CODE	MEANING
INDOOR	-	-	-	Normal
	1 time	-		Refrigerant cycle fault
	2 times	-	-	Outdoor unit is under forced operation
	3 times	9 times		Communication error between indoor and outdoor units
	9 times	-		Indoor thermistor
	10 times	-		Abnormal rotating numbers
	13 times	-		IC401 data reading error
OUTDOOR	4 times	2 times		Peak current cut
	4 times	3 times		Compressor abnormal low speed rotation
	4 times	4 times		Compressor switching failure
	4 times	5 times		Overload lower limit cut

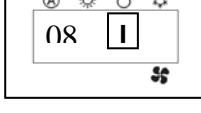
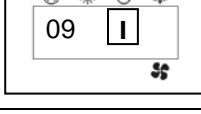
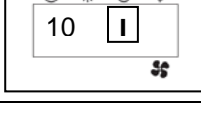
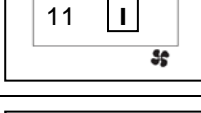
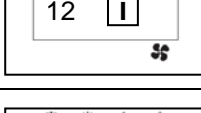
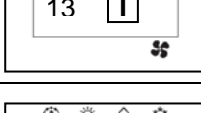
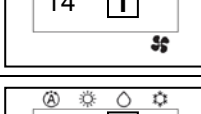
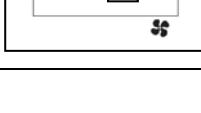
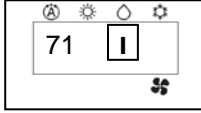
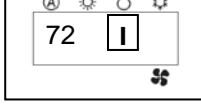
	TIMER LAMP BLINKING	LD301 BLINKING	CODE	MEANING
OUTDOOR	4 times	6 times		OH thermistor temperature rise
	4 times	7 times		Abnormal outdoor thermistor
	4 times	8 times		Accelaration defective
	4 times	9 times		Communication error
	4 times	10 times		Abnormal power source
	4 times	11 times		Fan stop for strong wind
	4 times	12 times		Fan motor fault
	4 times	13 times		EEPROM reading error
	4 times	14 times		Active converter defective
	4 times	15 times		Abnormal PWB circuit
		LD301 Lit LD302 BLINKING		
	4 times	1 times		Overheat thermostat
	4 times	2 times		Defrost thermostat

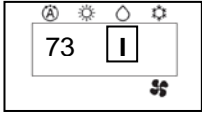
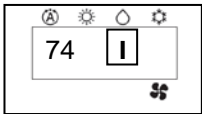
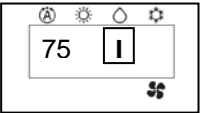
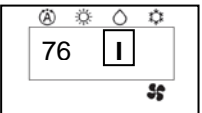
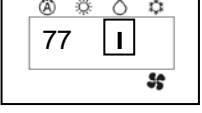
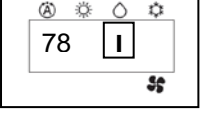
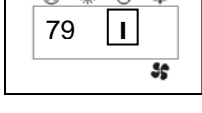
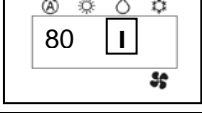
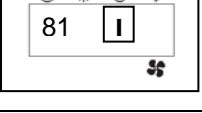
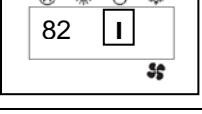
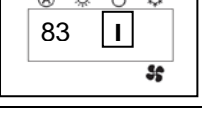
	TIMER LAMP BLINKING	LD301 Lit LD302 BLINKING	CODE	MEANING
OUTDOOR	4 times	3 times		Outdoor temperature thermostat
	4 times	4 times		Narrow pipe thermostat (indoor 1)
	4 times	5 times		Wide pipe thermostat (indoor 1)
	4 times	6 times		Narrow pipe thermostat (indoor 2)
	4 times	7 times		Wide pipe thermostat (indoor 2)
	4 times	8 times		Narrow pipe thermostat (indoor 3)
	4 times	9 times		Wide pipe thermostat (indoor 3)
	4 times	10 times		Narrow pipe thermostat (indoor 4)
	4 times	11 times		Wide pipe thermostat (indoor 4)
	4 times	12 times		Narrow pipe thermostat (indoor 5)
	4 times	13 times		Wide pipe thermostat (indoor 5)

10.2. H-LINK ADAPTOR – PSC 6RAD

10.2.1. SAFETY SUMMARY

DANGER:

- DO NOT pour water into the remote control switch (hereafter called “controller”). This product is equipped with electrical parts. This will cause serious electrical shock.

WARNING:

- DO NOT perform installation work and electrical wiring connection by yourself. Contact your distributor or dealer of HITACHI and ask then for installation work and electrical wiring by service person. The specified cable should be used to connect (i) room air conditioner and adaptor, and (ii) controller and adaptor.



CAUTION:



- DO NOT install the indoor unit, outdoor unit, controller and cable as such places as:
 - where there is oil vapor and dispersion of oil
 - where there is sulfuric environment (near the hot springs)
 - where there is a flammable gas
 - where there is salty environment (near the sea)
- DO NOT install the indoor unit, outdoor unit, controller and cable within approximately 3 meters from strong electromagnetic wave radiators, such as medical equipment. In case that the controller is installed in a place where there is electromagnetic wave direct-radiation, shield the controller and cables by covering with the steel box and running the cable through the metal conduit tube.
- In case that there is electric noise at the power source for the indoor unit, provide a noise filter.

10.2.2. INSTALLATION WORK

■ Before installation

Check the contents and the number of the accessories in the packing.

Adaptor	 <p>With two 1.8m cables</p>
1 piece of cover for hiding the covering	 <p>Attached 2 sided tapes</p>
Two-sided tape for attaching to Adaptor	 <p>110x40x3mm</p>

2 connectors for H-Link connection		
2 tapping screws for attaching to wall		φ3.0 x 10mm
2 screws for attaching to wooden wall		φ3.1 x 16mm

- 1) RAC adaptor can be installed to the wall as well as on the air conditioner itself
- 2) Install RAC adaptor in the vertical surface as shown below.

Upper side

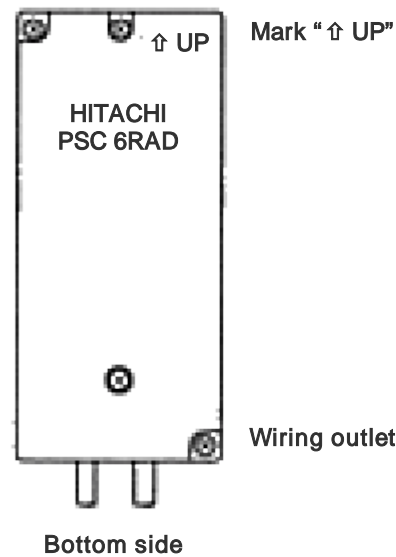

- 3) Installation procedure
 - a) When installing to the wall.
 - i) Fix the adaptor with 2 screws. Tapping screw is for metal surface, and other screw is for wooden surface.

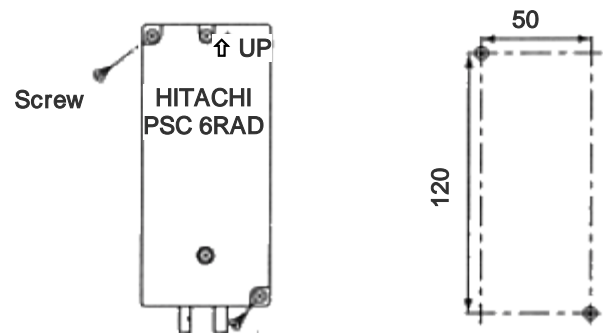

- ii) When using the cover
 - i) It can be installed at the right and left side of room air conditioner. Fix the cover and RAC adaptor with the two-sided tape (accessory).

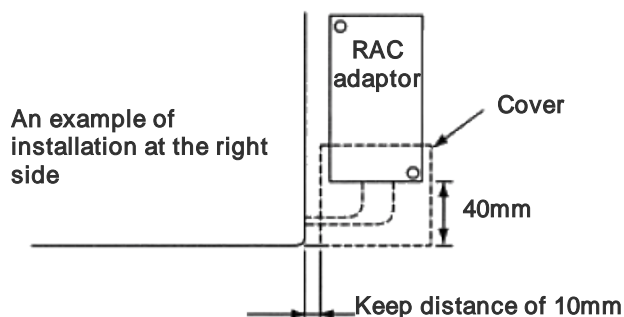

- b) When installing on the room air-conditioner
In case that it cannot be installed to the wall due to the space or material problem, install the RAC adaptor with the two-sided tape (accessory) on the room air-conditioner.
- Confirm if the piping cover of the unit can be removed when performing the service maintenance, and then fix the RAC adaptor in the side of room air-conditioner with two-sided tape. (Available at the right as well as left side)
 - Clean the surface to be installed with a dry cloth.

NOTE:

- Consider the following points since the adhesiveness changes according to the environmental conditions (temperature, humidity etc)
- The adhesiveness is decreased when there is humidity or oil.
- Warm the adhesive part and installation place of the two-sided tape to avoid the decrease of the adhesiveness in case the ambient temperature is low.
- DO NOT touch the adhesive part by fingers nor re-attach it many times. The adhesiveness has decreased and the RAC adaptor may fall off.
- DO NOT apply any force within 24 hours after installation.

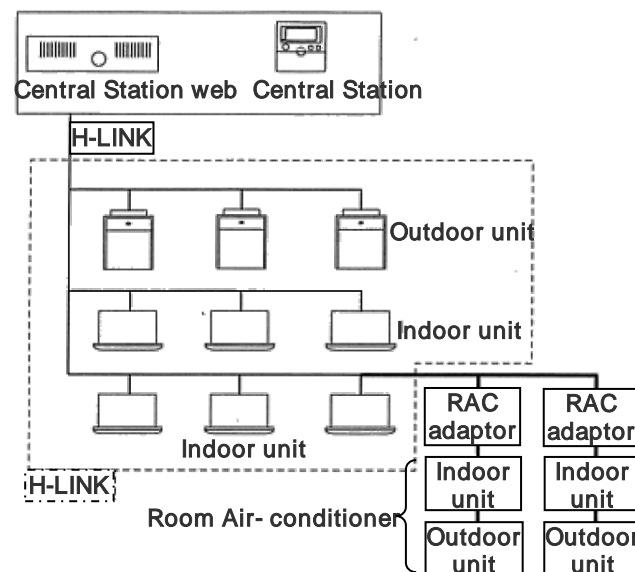
10.2.3. ELECTRICAL WIRING**■ System configuration****CAUTION:**

- Turn OFF the power supply of the room air-conditioner of the central control device when performing the wiring work
- DO NOT run all the H-LINK cable or power supply cable along the other signal cable, or malfunction may occur due to the noise, etc. If it is required to run along the other transmission cable, separate the cable more than 30cm, or run the cable through the metal tube and earth the tube.
- Follow local codes and regulations when performing electrical wiring and earth wiring.
- Transmissions cable used in H-LINK shall be 2 cores cable (0.7mm² to 1.25mm² for model: VCTF, VCT, CVV, MVVX, CVVX, VVR, VVF) or 2 cores twisted pair cable (model: KPEV, KPEV-Spec). Total length of cable shall be below 1000mm.
- DO NOT use wire with more than 3 cores.

■ Internal components and Wiring connections

Check the contents and the number of the accessories in the packing.

- Access
Open the cover by removing the ① and ② screws.

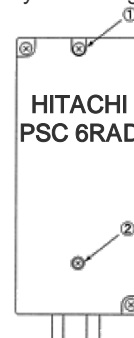

- Wiring Connection
Connection with Room Air-Conditioner
 - Remove the front cover of the room air-conditioner and the cover of electrical box.
 - The cable attached with the connector of the RAC adaptor shall be connected with the connector of indoor PCB

- iii) Install the electrical box cover paying attention not to clamp the cable. Read the installation manual of each room air-conditioner for confirming how to connect and how to assemble the cable of the RAC adaptor.

CAUTION:

- Disconnect the power plug before performing this work
- Turn OFF the break power source in case the power is supplied from the outdoor unit.

- Connection of Transmission Cable

H-LINK transmission cable connecting to RAC adaptor shall be connected to H-LINK.

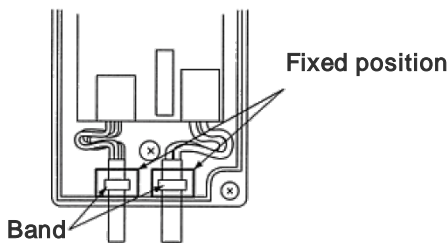
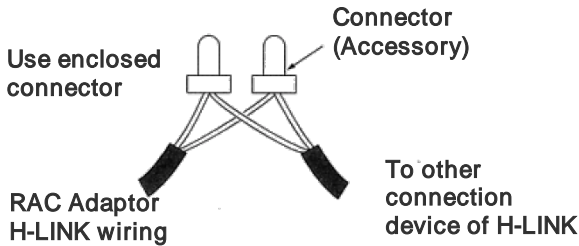

CAUTION:

- DO NOT connect incorrect wiring. It may cause the failure of the RAC Adaptor. Especially pay attention not to apply high voltage e.g. AC400/230V.
- DO NOT perform the wiring work while power to the central station or the RAC Adaptor is still being supplied. It may cause malfunction. Turn OFF devices when performing the wiring work.
- The RAC Adaptor side cable should not overload to the connector.
- DO NOT clamp the cable when attaching the RAC adaptor cover.
- Band should not be loose and in fixed position.

10.2.4. DIP SWITCH SETTING

- 1) Switch OFF the power of room air conditioner before setting the DIP switch. If the power is ON, the settings are INVALID.
- 2) The position of the DIP switch is shown below.

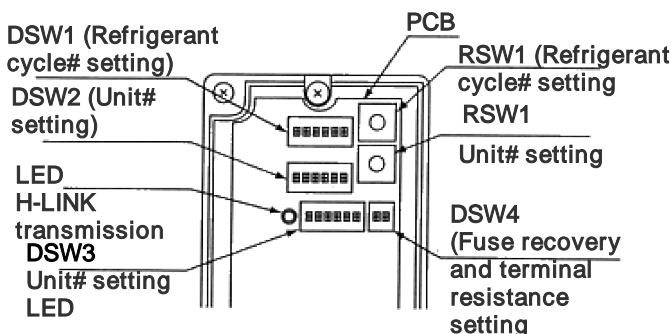

CAUTION:

- DO NOT turn ON various pins of DSW1 and DSW2

- 3) Set the refrigerant cycle# by RSW1 and DSW1

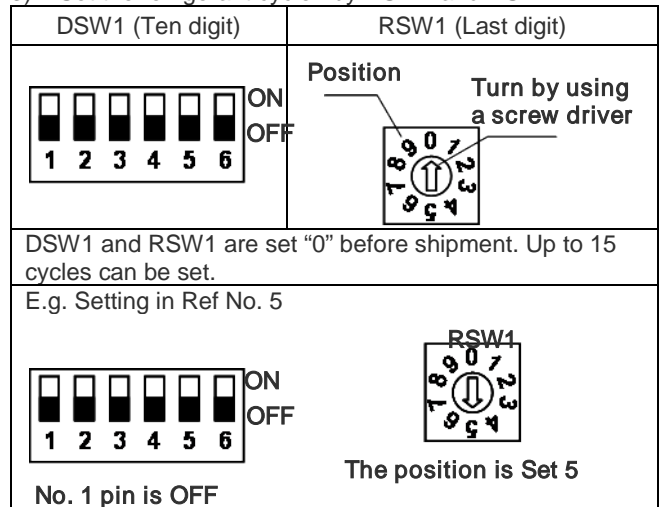

- 4) Set the unit No. by RSW2 and DSW2

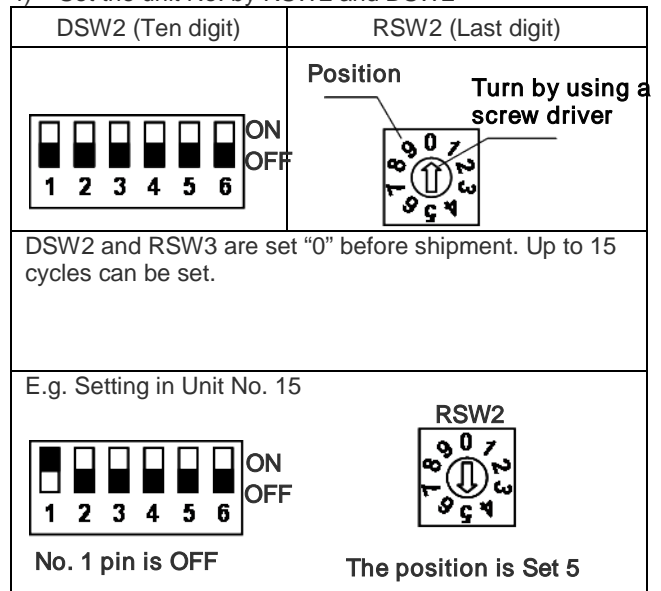

- 5) Slave unit.

In case of setting various RAC adaptors in the same refrigerant cycle, set the RAC adaptor with smallest Unit# as a master unit. In case of setting only one RAC adaptor in a refrigerant system, this adaptor should be a master unit. Set this procedure by DSW3.

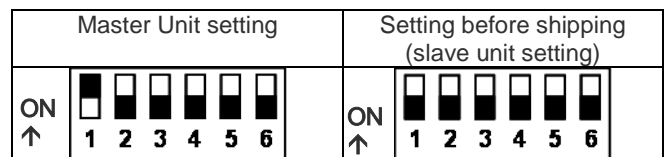

●: Master Unit setting

○: Setting before Shipping (Slave Unit setting)

		Indoor Unit#							
		0	1	2	3	4	5	6	7
Refrigerant Unit#	0	●	○	○	○	○			
	1			●	○	○			
	2				●	○	○	○	
	3		●						
	4								

CAUTION:

– DO NOT set various main adaptors in the same refrigerant cycle.

- 6) Procedure when applying 200V voltage to H-LINK wiring incorrectly.

In case of applying 200V voltage to H-LINK wiring incorrectly, the fuse installed in a transmission circuit on PCB will blow out. In this case, reconnect the wiring correctly and turn ON No. 2 pin of DSW4 on PCB. The transmission circuit can be recovered. (If applying this error again, the transmission circuit can not be recovered)

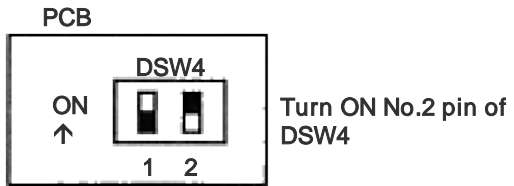

- 7) Terminating resistance is set in whole H-LINK system.
 - a) If H-LINK connecting devices like package air-conditioner are connected besides the RAC Adaptor, set the terminating resistance by those connecting devices. The terminating resistance should be set ON in only one position in whole H-LINK system.
 - b) In case that H-LINK is connected only by the RAC adaptor, set the terminating resistance by the RAC adaptor. The terminating resistance should be set ON in only one position in whole H-LINK system.

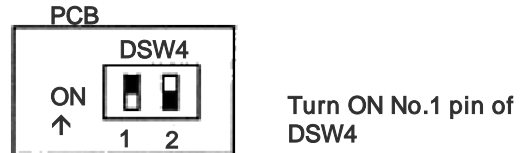

10.2.5. TEST RUN

Test run should be performed in the following after finishing the installation, wiring and setting. Refer to the installation manuals enclosed with the control system equipment.

- 1) Confirmation of RAC Adaptor Connection

Confirm if the RAC adaptor connection is recognized in the control system equipments. In case that it is not confirmed, check the transmission cable, refrigerant cycle #, indoor unit #, terminal resistance setting etc.
- 2) Registration

Confirm if the RAC adaptor connection is recognized.
- 3) Confirmation of RUN/STOP Operation.

Confirm if the room air-conditioner operate correctly by RUN/STOP from the central control system equipments. Check also if the room air-conditioner operation changes correctly by each setting.

10.3. DRY CONTACT (SPX-WDC3) APPLICATION (USING DIP SWITCH)

The dry contact system enables the operation of the air conditioner indoor unit to be controlled by using external dry contacts (with non voltage) such as card-key controller or window for facilities such as hotels.

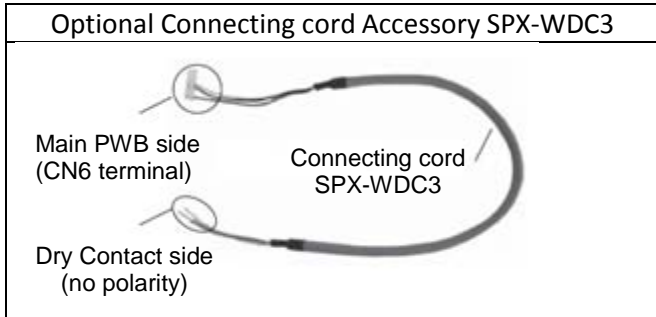

Note:

- 1) DRY CONTACT function is "Enable" by set pin No. 2 of the DIP SWITCH (DSW1) to ON position.
- 2) Select the proper setting for DRY CONTACT LOGIC INPUT pin No. 3 on DIP SWITCH (DSW1)
 - i) Set to OFF position (Hi Input) if the type of Dry Contact switch to be used (for the CARD KEY UNIT or Window) is of contact type a (Normally Open Type) as shown in below diagram.
 - ii) Set to ON position (Lo Input) if the type of Dry contact switch to be used (for the CARD KEY UNIT or Window) is of contact type b (Normally Close Type) as shown in below diagram.

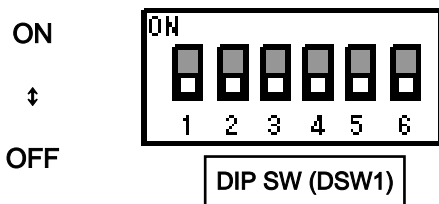

Pin No.	Function	Switch Position / Setting			
		OFF	Disable	ON	Enable
2	DRY CONTACT function	OFF	Disable	ON	Enable
3	DRY CONTACT Input Logic	OFF	HI Input Active	ON	LO Input Active

- Please decide the type of dry contact you will be using and set the position of the DIP Switch No. 2 and 3 accordingly

[1] CHECK DRY CONTACT OF CARD KEY UNIT

	AIR CONDITIONER Standby	AIR CONDITIONER Operating
	CARD KEY (Door Switch)	REMOVE
Contact type a	OPEN 	CLOSE
Contact type b	CLOSE 	OPEN

[2] SET THE POSITION OF DIP SWITCH

POSITION CONDITION OF DIP SWITCH	
<p>INITIAL CONDITION (CARD KEY NO USE) No.2 : OFF No.3 : OFF</p>	
<p>HI Input Active No.2 : ON No.3 : OFF</p>	
<p>LO Input Active No.2 : ON No.3 : ON</p>	

After all connection has been done as below diagram, ON the breaker and push ON button of wireless remote controller or wired remote controller to operate the air conditioner unit.

- When the CARD KEY is in insert condition, the air conditioner operation is allowable by remote controller.
- When the dry contact switch on the Card Key Unit is open (refer to diagram below for contact type a), the unit stops to operate (it takes 10 seconds to stop the unit operation after the dry contact switch on the card key turns off) and vice versa.
- When the card key is removed from the Card Key Unit, the wireless remote controller cannot be used.
- When the card key is removed from the Card Key Unit, the wired remote controller LCD display is activated; however it has no control over the unit.
- The suitable accessory Connecting Cord (accessory code#: SPX-WDC3) need to be used to connect the Card Key Unit's dry contact switch to the connector on the control board of the indoor unit

Example of wiring connection to Card Key Unit will be as below (reference only)

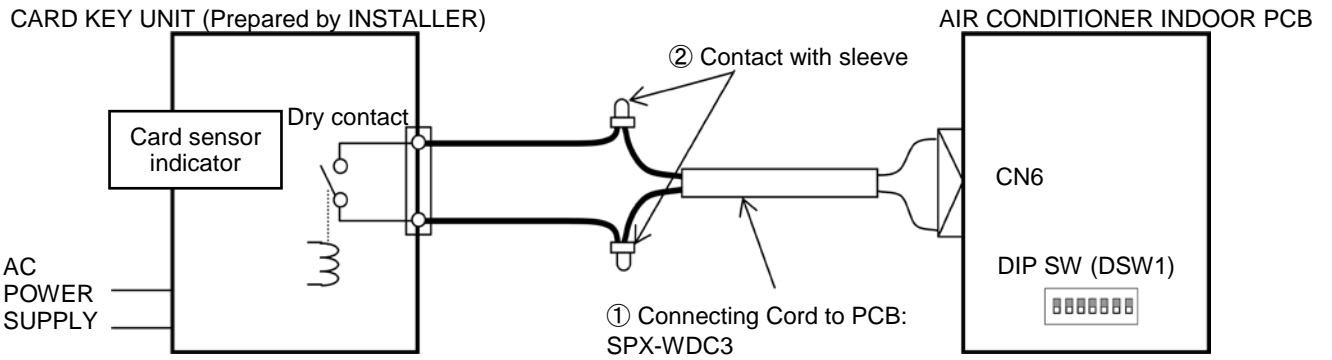

• CONNECTION EXAMPLE

i. Pin No. 3 of DIP SWITCH is set to OFF position (HI Input Active) for Dry Contact Type a

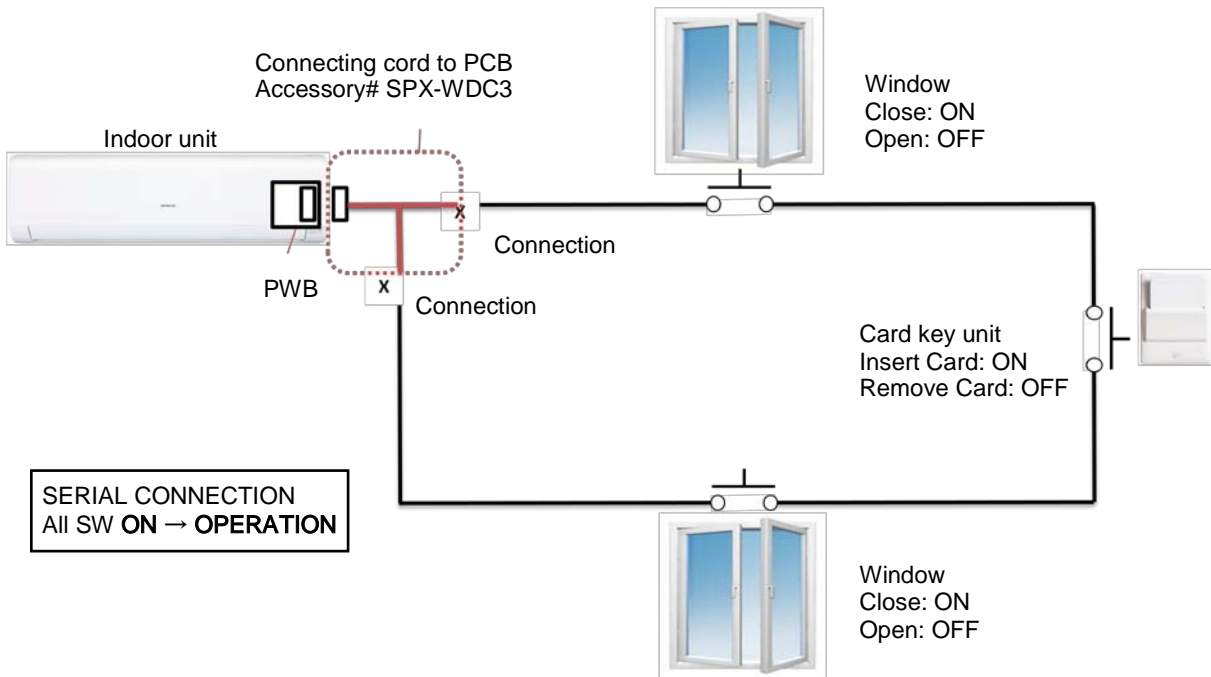

ii. Pin No. 3 of DIP SWITCH is set to ON position (LO Input Active) for Dry Contact Type b

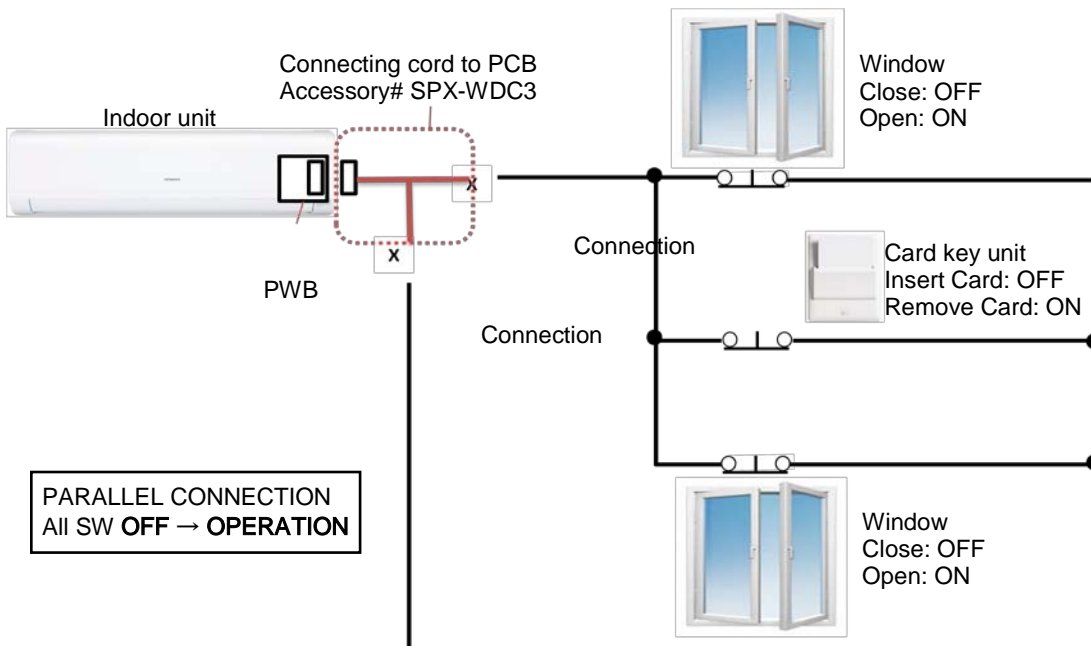

Please refer to the actual manual supplied with the optional connecting cords SPX-WDC3 for more details.

10.4. DISTRIBUTOR – SPX-DST1

The optional distributor is to be used together with the wired remote controller when there is a need to centralize the control of multiple indoor units using only a single wired remote controller.

A single distributor could be connected further to 3 separate distributors so that up to 13 units of indoor could be controlled by a single wired remote controller.

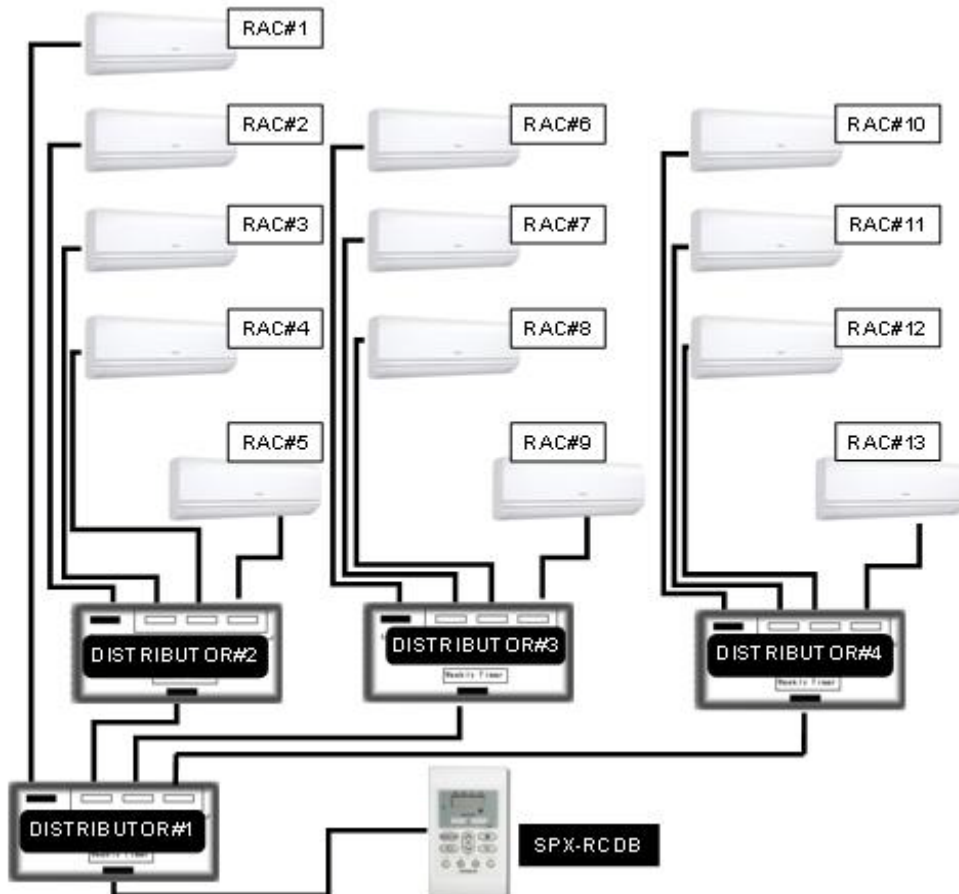
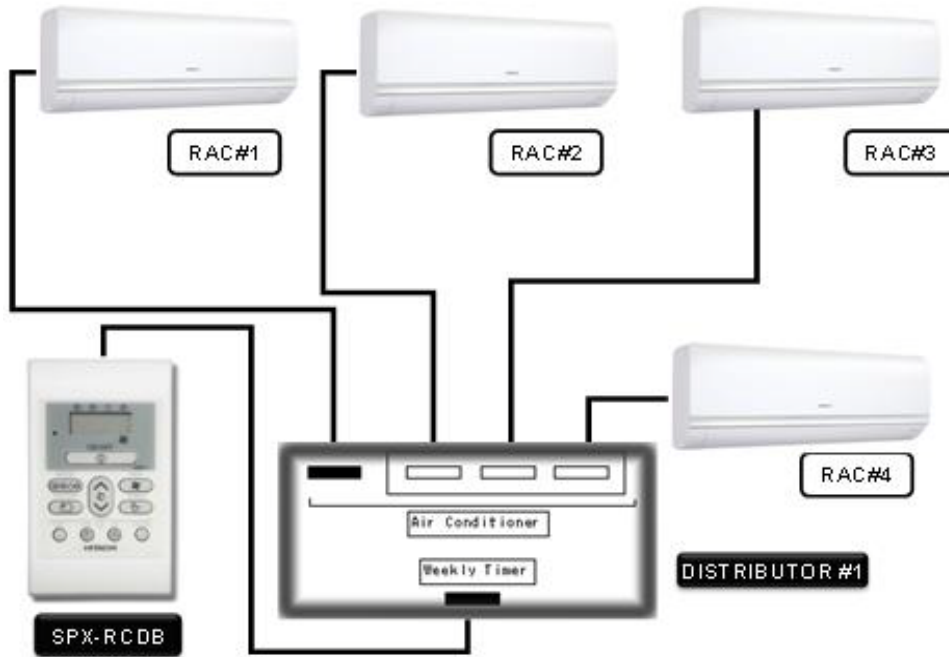

HITACHI

TC_ERP-FXB00-03/15