

TECHNICAL CATALOGUE

UTOPIA

R32 SERIES

R410A SERIES

MODELS

RAS-3HVRC2

RAS-(4-6)H(V)RC2E - RAS-(4-6)H(V)RP2E

RAS-(4-6)H(V)NC2E - RAS-(4-6)H(V)NP2E



Cooling & Heating

air

Contents

General Information	1
Features and benefits	2
General data	3
Capacities and selection data	4
Acoustic characteristic curves	5
Working range	6
General dimensions	7
Refrigerant cycle	8
Piping work and refrigerant charge	9
Electrical wiring	10
Troubleshooting	11

General Index

1.	General Information.....	1
1.1	General information.....	2
1.1.1	Introduction.....	2
1.2	Applied symbols.....	3
1.3	Norms and Regulations.....	3
1.4	Product guide.....	4
1.4.1	Classification of outdoor unit models.....	4
1.4.2	Classification of indoor unit models.....	4
1.4.3	Product line-up: Outdoor units.....	5
1.4.4	Outdoor unit accessory code list.....	6
1.4.5	Product line-up: indoor units.....	7
1.4.6	Product line-up: KPI energy recovery unit.....	11
1.4.7	Product line-up: DX-Interface.....	11
1.4.8	Product line-up: Econofresh.....	11
1.4.9	Multi-Kits.....	12
1.4.10	Individual remote controls.....	12
1.4.11	Receiver kit for combination with wireless remote control switch.....	13
1.4.12	Centralised remote controls.....	14
1.4.13	Building air conditioning controls.....	14
1.4.14	Gateways for building management systems (BMS).....	15
1.4.15	Control support devices.....	16
1.4.16	Control accessories.....	16
2.	Features and benefits.....	17
2.1	Features and benefits.....	18
2.1.1	Improvements of UTOPIA Prime / UTOPIA IVX Prime Series.....	18
2.1.2	R32 refrigerant.....	18
2.2	Eco-Design and Seasonal Efficiency.....	19
2.2.1	Eco-Design.....	19
2.2.2	Seasonal Efficiency.....	19
2.2.3	Energy classes and energy label (Lot 10).....	20
2.3	General features and benefits of the UTOPIA Prime / UTOPIA IVX Prime Series.....	22
2.3.1	Main features.....	22
2.4	Selection benefits.....	24
2.4.1	Wide range of UTOPIA outdoor units.....	24
2.4.2	Wide range of indoor units combinable with UTOPIA Prime and UTOPIA IVX Prime.....	25

2.5	Installation benefits.....	26
2.6	Start-up benefits.....	27
2.6.1	Automatic start-up test.....	27
2.6.2	Service verification.....	28
2.7	Maintenance benefits.....	29
2.7.1	Availability of maintenance tools.....	29
2.7.2	Simple maintenance.....	29
3.	General data.....	31
3.1	General information.....	32
3.2	General specifications.....	33
3.3	Cooling and heating performance.....	41
3.3.1	UTOPIA Prime single phase series.....	41
3.3.2	UTOPIA IVX Prime single phase series.....	41
3.3.3	UTOPIA Prime three phase series.....	42
3.3.4	UTOPIA IVX Prime three phase series.....	42
3.4	Component data.....	43
3.5	Electrical data.....	45
3.5.1	UTOPIA series.....	46
4.	Capacities and selection data.....	47
4.1	Combinability range.....	48
4.1.1	Connected number of indoor units.....	48
4.1.2	Connected capacity ratio.....	49
4.2	System selection procedure.....	50
4.2.1	Selection procedure (step 1).....	50
4.2.2	Selection procedure (step 2).....	52
4.3	Maximum cooling capacity.....	53
4.4	Maximum heating capacity.....	55
4.5	Correction indoor fan speed factor.....	57
4.5.1	Cooling.....	57
4.5.2	Heating.....	57
4.6	Piping length correction factor (f_{LC} , f_{LH}).....	57
4.7	Defrost Operation correction factor (f_D).....	59
4.8	Correction ratio due to humidity (CR).....	59
4.9	Correction factor according to altitude (f_{AL}).....	59

5.	Acoustic characteristic curves	61
5.1	Overall sound level.....	62
5.2	Sound pressure curves	63
5.3	Sound power curves.....	65
6.	Working range	67
6.1	Working range	68
6.1.1	Power supply.....	68
6.1.2	Temperature working range.....	68
6.1.3	Special DSW configuration for low ambient temperature (-15°C) - only for simultaneous operation mode units (UTOPIA Prime).....	69
7.	General dimensions	71
7.1	Dimensions.....	72
7.1.1	RAS-3HVRC2.....	72
7.1.2	RAS-(4-6)H(V)(R/N)(C/P)2E	73
7.2	Service space.....	74
7.2.1	Basic sizes	74
7.2.2	RAS-3HVRC2.....	75
7.2.3	RAS-(4-6)H(V)(R/N)(C/P)2E	77
8.	Refrigerant cycle	79
8.1	General notes.....	80
8.2	RAS-3HVRC2.....	80
8.3	RAS-(4-6)H(V)(R/N)(C/P)2E	81
9.	Piping work and refrigerant charge	83
9.1	Refrigerant pipe selection.....	84
9.1.1	Pipe size selection.....	84
9.1.2	Multikit or distributor selection	84
9.2	Refrigerant piping range.....	84
9.2.1	Refrigerant piping length	84
9.2.2	Piping system for header branch.....	85
9.2.3	Maximum length of refrigerant piping	86
9.2.4	Combinations of piping size and piping length	88
9.2.5	Refrigerant piping size and multikit/distributor.....	88
9.3	Copper pipes, sizes and connection	90
9.3.1	Copper pipes and sizes.....	90
9.3.2	Insulation	91

9.4	Refrigerant charge amount.....	92
9.4.1	Refrigerant charge before shipment (W_0 (kg)).....	92
9.4.2	Calculation method for the additional refrigerant charge.....	92
9.5	Caution in case of refrigerant leakage.....	94
9.5.1	Maximum permitted concentration of hydrofluorocarbon (HFC)	94
9.5.2	Calculation of refrigerant concentration.....	94
9.5.3	Countermeasure for R410A refrigerant leakage.....	95
10.	Electrical wiring	97
10.1	General information.....	98
10.1.1	Electromagnetic compatibility.....	98
10.1.2	Harmonics	99
10.2	General verifications.....	99
10.3	DIP and RSW switches settings.....	99
10.3.1	RAS-3HVRC2.....	99
10.3.2	RAS-(4-6)H(V)(R/N)(P/C)2E	102
10.4	System wiring diagram.....	105
10.4.1	Outdoor and indoor unit electrical wiring.....	105
10.4.2	Wire size.....	106
10.5	H-LINK II system	107
10.5.1	Features	107
10.5.2	Specifications	107
10.5.3	DIP Switch setting for 2, 3 and 4 indoor units systems	108
10.5.4	Examples of the system of connection between H-LINK and H-LINK II units.....	110
10.5.5	Examples of H-LINK II system	111
10.6	System Control - Main concept.....	113
10.6.1	UTOPIA Prime.....	113
10.6.2	UTOPIA IVX Prime.....	114
10.6.3	System control comparison.....	115
11.	Troubleshooting.....	117
11.1	On-screen displays during abnormal operation.....	118
11.2	Alarm codes	120

1 . General Information

Index

1.1	General information.....	2
1.1.1	Introduction.....	2
1.2	Applied symbols	3
1.3	Norms and Regulations.....	3
1.4	Product guide	4
1.4.1	Classification of outdoor unit models.....	4
1.4.2	Classification of indoor unit models.....	4
1.4.3	Product line-up: Outdoor units.....	5
1.4.4	Outdoor unit accessory code list	6
1.4.5	Product line-up: indoor units.....	7
1.4.6	Product line-up: KPI energy recovery unit.....	11
1.4.7	Product line-up: DX-Interface	11
1.4.8	Product line-up: Econofresh	11
1.4.9	Multi-Kits.....	12
1.4.10	Individual remote controls	12
1.4.11	Receiver kit for combination with wireless remote control switch.....	13
1.4.12	Centralised remote controls	14
1.4.13	Building air conditioning controls.....	14
1.4.14	Gateways for building management systems (BMS)	15
1.4.15	Control support devices.....	16
1.4.16	Control accessories.....	16

1.1 General information

© Copyright 2021 Johnson Controls-Hitachi Air Conditioning Spain, S.A.U. – All rights reserved.

No part of this publication may be reproduced, copied, filed or transmitted in any shape or form without the permission of Johnson Controls-Hitachi Air Conditioning Spain, S.A.U.

Within the policy of continuous improvement of its products, Johnson Controls-Hitachi Air Conditioning Spain, S.A.U. reserves the right to make changes at any time without prior notification and without being compelled to introducing them into products subsequently sold. This document may therefore have been subject to amendments during the life of the product.

Hitachi makes every effort to offer correct, up-to-date documentation. Despite this, printing errors cannot be controlled by Hitachi and are not its responsibility.

As a result, some of the images or data used to illustrate this document may not refer to specific models. No claims will be accepted based on the data, illustrations and descriptions included in this manual.

No type of modification must be made to the equipment without prior, written authorization from the manufacturer.

Hitachi pursues a policy of continued improvement in design and performance of Products. The right is therefore reserved to vary specifications without notice. Hitachi cannot anticipate every possible circumstance that might involve a potential hazard. No part of this manual may be reproduced without written permission.

1.1.1 Introduction

Hitachi UTOPIA Prime/ UTOPIA IVX Prime series is an outdoor unit series designed with the goal to cover the requirements of the split and multisplit systems, for installations where from one indoor unit (single system) to up to 4 indoor units, are connected to the same UTOPIA outdoor unit (depending on model).

New UTOPIA series consists in two different outdoor unit series: UTOPIA Prime and UTOPIA IVX Prime, which compliant with the Eco Design (ErP) and Energy Labelling (ELD) directives about seasonal energy performance:

- ErP 206/2012& ELD (626/2011) for models up to 12kW of Cooling capacity
- ErP 2016/2281 for models higher than 12kW of Cooling capacity

The Seasonal Energy Efficiency Ratio (SEER) in cooling and the Seasonal Coefficient of Performance (SCOP) in heating, show an approach values to the real energy consumption.

UTOPIA series incorporate the Hitachi inverter technology, which makes possible to adapt automatically and without the user operation the capacity of the unit, so the power input, to the real demand of the installation, increasing the system efficiency to unattainable levels with other technologies. All UTOPIA units are equipped with a heat pump, resulting in an air conditioning system valid for the whole year, in which the installation of additional and specific systems are not necessary.

Nominal capacity from 7 kW to 14 kW (cooling mode). Connectable indoor units up to 4 units (depending on model) and total combination power from 90% up to 115% for outdoor units from 4 to 6HP, or 90% up to 100% for 3HP outdoor units.

One of the main merits of Hitachi indoor units range is the combinability and flexibility of its indoor units SYSTEM FREE. This outstanding technology makes possible to use the same indoor units with both UTOPIA and SET FREE outdoor units, making easier the design, installation and control of the air conditioning installations.

1.2 Applied symbols

During normal air conditioning system design work or unit installation, greater attention must be paid in certain situations requiring particular care in order to avoid damage to the unit, the installation or the building or property.

Situations that jeopardise the safety of those in the surrounding area or that put the unit itself at risk will be clearly indicated in this manual.

A series of special symbols will be used to clearly identify these situations.

Pay close attention to these symbols and to the messages following them, as your safety and that of others depends on it.

DANGER

- *The text following this symbol contains information and instructions relating directly to your safety, in addition to hazards or unsafe practices which could result in severe personal injuries or death.*
- *Not taking these instructions into account could lead to serious, very serious or even fatal injuries to you and others in the proximities of the unit.*

In the texts following the danger symbol you can also find information on safe procedures during unit installation.

CAUTION

- *The text following this symbol contains information and instructions relating directly to your safety, in addition to hazards or unsafe practices which could result in minor personal injury or product or property damage*
- *Not taking these instructions into account could lead to minor injuries to you and others in the proximities of the unit.*
- *Not taking these instructions into account could lead to unit damage.*

In the texts following the caution symbol you can also find information on safe procedures during unit installation.

NOTE

- *The text following this symbol contains information or instructions that may be of use or that require a more thorough explanation.*
- *Instructions regarding inspections to be made on unit parts or systems may also be included.*

1.3 Norms and Regulations

Following Regulation EU N° 517/2014 on Certain Fluorinated Greenhouse gases, it is mandatory to fill in the label attached to the unit with the total amount of refrigerant charged on the installation.

Do not vent R32 into the atmosphere: R32 is fluorinated greenhouse gas covered by the Kyoto protocol global warming potential (GWP) R32 = 675.

Do not vent R410A into the atmosphere: R410A are fluorinated greenhouse gases covered by the Kyoto protocol global warming potential (GWP) R410A = 2088.

Tn of CO₂ equivalent of fluorinated greenhouse gases contained is calculated by indicated GWP * Total Charge (in kg) indicated in the product label and divided by 1000.

Appropriate refrigerant

The refrigerant used in each unit is identified on the specification label and manuals of the unit. Hitachi shall not be held liable for any failure, trouble, malfunction or accident caused by units illegally charged with refrigerants other than the specified one.

Consequences of charging non-specified refrigerant

It may cause mechanical failure, malfunction and other accidents.

It may cause operational failure of protection and safety devices of air conditioners.

It may also cause lubrication failure of the sliding part of the compressor due to deterioration of refrigerant oil.

In particular, hydrocarbon refrigerants (such as propane, R441A, R443A, GF-08, etc.) are not allowed, since these are combustible and may cause major accidents such as fire and explosion in case of improper handling.

Once a non-specified refrigerant has been charged, no further servicing (including draining of refrigerant) shall be performed, even in case of malfunction. Improper handling of refrigerant may be a cause of fire and explosion, and servicing in such cases may be considered an illegal act.

End clients and costumers shall be informed that servicing is not approved, and the installer who charged the non-specified refrigerant shall be asked to fix the unit.

Hitachi will accept no responsibility for units that have been charged with non-specified refrigerant once.

1.4 Product guide

1.4.1 Classification of outdoor unit models

Unit type (Outdoor unit): RAS

	Position-separating hyphen (fixed)									
	Capacity (HP): 3, 4, 5, 6									
	H = Heat pump									
	V = Single phase unit (1~ 230V 50Hz)									
	- = Three phase unit (3N~ 400V 50Hz)									
	R = R32 refrigerant									
	N = R410A refrigerant									
	C: Simultaneous operation mode									
	P: Individual operation mode									
	2 = series 2									
	E = Made in Europe									
	- = Made in Japan									
RAS	-	X	H	(X)	X	X	2	(X)		



1.4.2 Classification of indoor unit models

Unit type (indoor unit): RCI, RCIM, RCD, RPC, RPI, RPK, RPF, RPF1



	Position-separating hyphen (fixed)									
	Capacity (HP): 0.4, 0.6, 0.8, 1.0, 1.5, 2.0, 2.5, 3.0, 4.0, 5.0, 6.0, 8.0, 10.0, 16.0, 20.0									
	FS = SYSTEM FREE									
	R = R32 / R410A refrigerant									
	N = R410A refrigerant									
	H = Hotel (RPK-(0.4-1.5) only)									
	2/3/6 = series									
	P= Pair									
	E = Made in Europe									
	M = Made in Malaysia									
	- = Made in Japan or China									
	(-f) = Non-flammable insulation (RPI-(8.0-20.0)FSN3(P)E-f only)									
	(-EF) = Ducted indoor unit for econofresh assembly (RPI-(4.0-6.0)FSN6E-EF only)									
XXX	-	X.X	FS	(X)	(H)	X	(P)	(X)	(X)	

1.4.3 Product line-up: Outdoor units

◆ UTOPIA Prime (Simultaneous operation models)



❄️🔥									
R32					R410A				
1~ 230V 50Hz			3N~ 400V 50Hz		1~ 230V 50Hz			3N~ 400V 50Hz	
									
Unit	Code	Unit	Code	Unit	Code	Unit	Code	Unit	Code
RAS-3HVRC2	60289185								
		RAS-4HVRC2E	7E303034	RAS-4HRC2E	7E303134	RAS-4HVNC2E	7E305055	RAS-4HNC2E	7E305155
		RAS-5HVRC2E	7E303035	RAS-5HRC2E	7E303135	RAS-5HVNC2E	7E305056	RAS-5HNC2E	7E305156
		RAS-6HVRC2E	7E303036	RAS-6HRC2E	7E303136	RAS-6HVNC2E	7E305057	RAS-6HNC2E	7E305157

◆ UTOPIA IVX Prime (Individual operation models)

❄️🔥							
R32				R410A			
1~ 230V 50Hz		3N~ 400V 50Hz		1~ 230V 50Hz		3N~ 400V 50Hz	
							
Unit	Code	Unit	Code	Unit	Code	Unit	Code
RAS-4HVRP2E	7E303234	RAS-4HRP2E	7E303334	RAS-4HVNP2E	7E305255	RAS-4HNP2E	7E305355
RAS-5HVRP2E	7E303235	RAS-5HRP2E	7E303335	RAS-5HVNP2E	7E305256	RAS-5HNP2E	7E305356
RAS-6HVRP2E	7E303236	RAS-6HRP2E	7E303336	RAS-6HVNP2E	7E305257	RAS-6HNP2E	7E305357

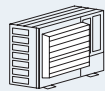
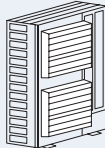
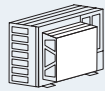
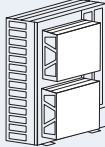
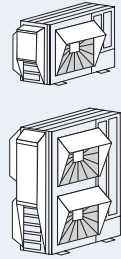

1.4.4 Outdoor unit accessory code list

Name	OU Reference	Description	Code	Figure
DBS-12L	RAS-3HVRC2	Drain discharge connection	60291491	
DBS-26	RAS-(4-6)H(V)(R/N)(C/P)2E	Drain discharge connection	60299192	
AG-264	RAS-3HVRC2	Air flow guide	60209100	
AG-335A	RAS-(4-6)H(V)(R/N)(C/P)2E	Air flow guide	60291432	
WSP-264	RAS-3HVRC2	Wind guard	60291831	
WSP-335A	RAS-(4-6)H(V)(R/N)(C/P)2E	Wind guard	60291432	
Snow protection hood				
Name	OU Reference	Description	Code	Figure
ZINC PLATE				
ASG-SP10FTB (Half)	RAS-3HVRC2	Air outlet	60292336	
ASG-SP11FTB (Full)			60292339	
ASG-NP335F1 (Half)	RAS-(4-6)H(V)(R/N)(C/P)2E		60291771	
ASG-SP11FB (Full)			60291782	
ASG-SP10BTB	RAS-3HVRC2	Air inlet of rear side	60292337	
ASG-SP10BE	RAS-(4-6)H(V)(R/N)(C/P)2E		60291938	
ASG-SP10LTB	RAS-3HVRC2	Air inlet of left side	60292338	
ASG-SP10LE	RAS-(4-6)H(V)(R/N)(C/P)2E		60291939	
STAINLESS PLATE				
ASG-NP335FS4 (Half)	RAS-(4-6)H(V)(R/N)(C/P)2E	Air outlet	60291940	
ASG-SP2 (Full)			60291947	
ASG-SP10BES2	RAS-(4-6)H(V)(R/N)(C/P)2E	Air inlet of rear side	60291943	
ASG-SP10LES2	RAS-(4-6)H(V)(R/N)(C/P)2E	Air inlet of left side	60291944	

NOTE

Hitachi has a range of accessories and remote control systems that can be used with the UTOPIA Prime and UTOPIA IVX Prime series outdoor units. Please, refer to the Controls Technical Catalogue.

1.4.5 Product line-up: indoor units

NOTE

- The indoor unit models and codes are the last updated at time of publication; other previous models and coming developments could be available for combination with the outdoor unit series.
- Check the indoor unit compatibility (model, series, size,...) with your outdoor model name.
- Check the exact classification for each unit (model, type, power and series) in "1.4.1 Classification of outdoor unit models".



◆ RCI and RCIM indoor units

RCI (R32 / R410A)		RCIM (R32 / R410A)	
			
			
4-way cassette		4-way cassette (compact)	
Unit	Code	Unit	Code
		RCIM-0.4FSRE (*1)	7E414148
		RCIM-0.6FSRE (*2)	7E414137
		RCIM-0.8FSRE	7E414100
RCI-1.0FSR	70405301	RCIM-1.0FSRE	7E414101
RCI-1.5FSR	70405302	RCIM-1.5FSRE	7E414102
RCI-2.0FSR	70405303	RCIM-2.0FSRE	7E414103
RCI-2.5FSR	70405304	RCIM-2.5FSRE	7E414104
RCI-3.0FSR	70405305		
RCI-4.0FSR	70405307		
RCI-5.0FSR	70405308		
RCI-6.0FSR	70405309		
Panel		Panel	
P-N23NA2 (without Motion Sensor)	70532000	P-AP56NAM (without Motion Sensor)	70533000
P-AP160KA3 (Standard panel without Motion Sensor, black)	60279337	P-AP56NAMS (Motion Sensor embedded)	70533100
P-GP160NAP (Iconic panel, white)	60297331	P-AP56NAMR (Receiver kit embedded)	70533500
P-GP160KAP (Iconic panel, black)	60297334		
P-GP160NAPU (Iconic panel, with elevating grille)	60297339		

NOTE

- The RCI and RCIM models must be used in combination with the indicated panels.
- (*1): Follow the detailed information about the combinability and restrictions for 0.4 HP Indoor Units, which can only be used in combination with current SET FREE Mini (RAS-(4-6)FS(V)NME, RAS-(8-12)FSXNME) and SET FREE (RAS-FSXNSE, RAS-FSXNPE).
- (*2): 0.6 HP Indoor Units can only be used in combination with SET FREE Mini (RAS-(4-6)FS(V)NME, RAS-(8-12)FSXNME) and SET FREE (RAS-FSXNSE, RAS-FSXNPE).





◆ RCD and RPC indoor units

RCD (R32 / R410A)				RPC (R32 / R410A)	
					
					
2-way cassette				Ceiling type	
Unit	Code	Unit	Code	Unit	Code
RCD-0.8FSR (*)	60279168				
RCD-1.0FSR (*)	60279169				
RCD-1.5FSR (*)	60279170			RPC-1.5FSR	60279267
RCD-2.0FSR (*)	60279171			RPC-2.0FSR	60279268
RCD-2.5FSR (*)	60279172			RPC-2.5FSR	60279269
RCD-3.0FSR (*)	60279173			RPC-3.0FSR	60279270
		RCD-4.0FSR (*)	60279174	RPC-4.0FSR	60279271
		RCD-5.0FSR (*)	60279175	RPC-5.0FSR	60279272
		RCD-6.0FSR (*)	60279176	RPC-6.0FSR	60279273
Panel		Panel			
P-AP90DNA	60297319	P-AP160DNA	60297320		

**NOTE**

- The RCD models must be used in combination with the indicated panels.
- (*): 1 indoor unit combinations with UTOPIA Prime / UTOPIA IVX Prime and UTOPIA IVX Standard / Premium series not allowed.

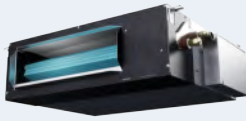
◆ RPI indoor units



DUCTED INDOOR UNIT (R32 / R410A)					
					
					
RPIL-FSRE		RPI-FSRE		RPIH-FSRE	
Unit	Code				
RPIL-0.4FSRE(*1)	7E426048				
RPIL-0.6FSRE (*2)	7E426037				
RPIL-0.8FSRE	7E426013				
RPIL-1.0FSRE	7E426014				
RPIL-1.5FSRE	7E426002	RPI-1.5FSRE	7E426015		
		RPI-2.0FSRE	7E426016		
		RPI-2.5FSRE	7E426017		
		RPI-3.0FSRE	7E426018		
		RPI-4.0FSRE	7E426020	RPIH-4.0FSRE	7E426007
		RPI-5.0FSRE	7E426021	RPIH-5.0FSRE	7E426008
		RPI-6.0FSRE	7E426022	RPIH-6.0FSRE	7E426009

 NOTE

- (*1): Follow the detailed information about the combinability and restrictions for 0.4 HP Indoor Units, which can only be used in combination with current SET FREE RAS-FSXNSE, RAS-FSXNPE and SIDE FLOW RAS-FS(X)NME.
- (*2) 0.6 HP Indoor Units can only be used in combination with SET FREE RAS-FSXNSE and RAS-FSXNPE series and SIDE FLOW RAS-FS(X)NME.

DUCTED INDOOR UNIT for ECONOFRESH ASSEMBLY (R410A)	
	
	
Unit	Code
RPI-4.0FSN6E-EF	7E426027
RPI-5.0FSN6E-EF	7E426028
RPI-6.0FSN6E-EF	7E426029

◆ RPK, RPF and RPFI indoor units

RPK (R32 / R410A)		RPF (R410A)		RPFI (R410A)	
					
Wall type		Floor type		Floor concealed type	
Unit	Code	Unit	Code	Unit	Code
RPK-0.4FSRM (*1)	60279204				
RPK-0.4FSRHM (*1)	60279221				
RPK-0.6FSRM (*2)	60279205				
RPK-0.6FSRHM (*2)	60279222				
RPK-0.8FSRM	60279206				
RPK-0.8FSRHM	60279223				
RPK-1.0FSRM	60279207				
RPK-1.0FSRHM	60279224	RPF-1.0FSN2E	7E450001	RPFI-1.0FSN2E	7E460001
RPK-1.5FSRM	60279208				
RPK-1.5FSRHM	60279225	RPF-1.5FSN2E	7E450002	RPFI-1.5FSN2E	7E460002
RPK-2.0FSRM	60279209	RPF-2.0FSN2E (*3)	7E450003	RPFI-2.0FSN2E (*3)	7E460003
RPK-2.5FSRM	60279210	RPF-2.5FSN2E (*3)	7E450004	RPFI-2.5FSN2E (*3)	7E460004
RPK-3.0FSRM	60279211				
RPK-4.0FSRM	60279212				
Expansion valve kit (*4)					
EV-1.5N1 (*4)	60921792				

 **NOTE**

- (*1): Follow the detailed information about the combinability and restrictions for 0.4 HP Indoor Units, which can only be used in combination with current SET FREE Mini (RAS-(4-6)FS(V)NME, RAS-(8-12)FSXNME) and SET FREE (RAS-FSXNSE, RAS-FSXNPE).
- (*2): 0.6 HP Indoor Units can only be used in combination with SET FREE Mini (RAS-(4-6)FS(V)NME, RAS-(8-12)FSXNME) and SET FREE (RAS-FSXNSE, RAS-FSXNPE).
- (*3) 1 indoor unit combinations with UTOPIA Prime / UTOPIA IVX Prime and UTOPIA IVX Standard / Premium series not allowed.
- (*4) For RPK-(0.4-1.5)FSRHM models only.

1.4.6 Product line-up: KPI energy recovery unit

KPI			
			
Energy recovery		Active (Energy Recovery+ R410A DX section)	
Unit	Code	Unit	Code
KPI-252E4E	70603000		
KPI-502E4E	70603001	KPI-502X4E	70603201
KPI-802E4E	70603002	KPI-802X4E	70603202
KPI-1002E4E	70603003	KPI-1002X4E	70603203
KPI-1502E4E	70603004		
KPI-2002E4E	70603005		

1.4.7 Product line-up: DX-Interface

DX-Interface (R410A)		
 <p>Control box</p> <p>Expansion valve box</p>	Unit	Code
	EXV-2.0E2	7E611000
	EXV-2.5E2	7E611001
	EXV-3.0E2	7E611002
	EXV-4.0E2	7E611003
	EXV-5.0E2	7E611004
	EXV-6.0E2	7E611005
	EXV-8.0E2	7E611006
	EXV-10.0E2	7E611007

1.4.8 Product line-up: Econofresh

Econofresh (R410A)	
	
Unit	Code
EF-456N1E	7E560001



i NOTE

The EF-456N1E unit can only be installed in combination with the following units:



- RPI-4.0FSN6E-EF (7E426027)
- RPI-5.0FSN6E-EF (7E426028)
- RPI-6.0FSN6E-EF (7E426029)

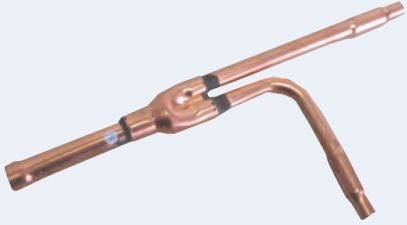





1.4.9 Multi-Kits

Name	Description	Code	Figure
E-102SN4	Branch Pipe	70524201	
E-162SN4		70524202	
MH-84AN1	Header Branch	70522009	

1.4.10 Individual remote controls





Name	Description	Code	Figure
PC-ARFP1E	Remote control with timer	70510003	
PC-ARH1E	Simplified remote control	70510004	
PC-AWR	Wireless remote control	60291969	

1.4.11 Receiver kit for combination with wireless remote control switch







Receiver kit name	Indoor unit application	Compatible wireless remote control	Code	Figure
on the panel				
PC-ALH3	RCI-FSR	PC-AWR	60291767	
PC-ALHC1	RCIM-FSRE	PC-AWR	70590906	
PC-ALHD1	RCD-FSR	PC-AWR	60292053	
PC-ALHP1	RPC-FSR	PC-AWR	60291823	
on the wall				
PC-ALHZ1	RPI(L/H)-FSRE(-EF) RPI-FSN(3/6)(P)E(-f) RPF(I)-FSN2E RCI-FSR RCIM-FSRE RCD-FSR RPK-FSR(H)M RPC-FSR	PC-AWR	60292245	

1

1.4.12 Centralised remote controls

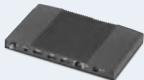
Name	Description	Code	Figure
PSC-A64GT	Touch screen central station	60291730	
PSC-A32MN	Touch screen central station mini	60291966	
PSC-A64S	Centralised remote control	60291479	
PSC-A16RS	Centralised ON/OFF control	60291484	





1.4.13 Building air conditioning controls

Name	Description	Code	Figure
CSNET Manager 2 T10	Centralised control with a touch interface of 10 inches which runs CSNET Manager 2 software to control the indoor units.	7E512203	
CSNET Manager 2 T15	Centralised control with a touch interface of 15 inches which runs CSNET Manager 2 software to control the indoor units.	7E512206	
CSNET Manager 2 SL	Centralised control interface screen-less which runs CSNET Manager 2 software to control the indoor units.	7E512204	
CSNET Lite	Centralised control which runs CSNET Lite software to control the indoor units in a small installations.	7E512205	
HC-A64NET	H-LINK gateway used by CSNET Manager Screens to communicate with indoor units (Max. 64 indoor units)	7E512200	
HC-IOTGW	airCloud PRO Gateway	60063203	





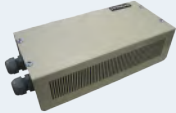

1.4.14 Gateways for building management systems (BMS)

Name	Description	Code	Figure
HC-A16MB	Integration with installation with intelligent control (Building Management System) Gateway Interface to MODBUS systems (Max. 16 indoor units).	7E513210	
HC-A64MB	Integration with installation with intelligent control (Building Management System) Gateway Interface to MODBUS systems (Max. 64 indoor units).	7E513205	
KNX001	Integration with installations with intelligent control (BMS) through CSNET WEB. Gateway Interface to KNX systems.	7E5121000	
HI-AC-KNX-16	Integration with installations with intelligent control (BMS) through CSNET Manager 2 and CSNET Lite. Gateway Interface to KNX systems.	70513303	
HI-AC-KNX-64	Integration with installations with intelligent control (BMS) through CSNET Manager 2 and CSNET Lite. Gateway Interface to KNX systems.	70513304	
HARC-BX E (A)	Integration with installation with intelligent control (Building Management System) Gateway Interface to LONWORKS systems. (H-LINK I communication) (Max. 64 units with 8 parameters)	60290874	
HARC-BX E (B)	Integration with installation with intelligent control (Building Management System) Gateway Interface to LONWORKS systems. (H-LINK I communication) (Max. 32 units with 16 parameters)	60290875	
HI-AC-BAC-16	BACnet gateway connectable to HC-A16MB	70513100	
HI-AC-BAC-64	BACnet gateway connectable to HC-A64MB	70513101	

1.4.15 Control support devices

Name	Description	Code	Figure
PSC-A1T	Programmable timer	60291482	
PSC-6RAD	H-LINK RAC Adapter	60063017	
PC-A1IO	Integration of external equipment into H-LINK	7E519000	
PSC-5HR	H-LINK Relay	60291105	
THM-R2AE	Remote temperature sensor (THM4)	7E299907	

1.4.16 Control accessories

Name	Description	Code	Figure
Wall support 2	Wall mounted support (for both CSNET Manager 2 T10 / T15)	7E512302	
Stand support	Stand mounted support (for both CSNET Manager 2 T10 / T15)	7E512301	
Din rail	Standard din rail for CSNET Lite	7E512303	
PCC-1A	Optional function connector	70590901	
PRC-10E1	2P-Extension cord (10 metres)	7E790211	
PRC-15E1	2P-Extension cord (15 metres)	7E790212	
PRC-20E1	2P-Extension cord (20 metres)	7E790213	
PRC-30E1	2P-Extension cord (30 metres)	7E790214	
Net Configuration Kit	Net configuration kit for HC-A(8/64)MB and HC-A64NET	7E512306	

2. Features and benefits

Index

2.1	Features and benefits.....	18
2.1.1	Improvements of UTOPIA Prime / UTOPIA IVX Prime Series.....	18
2.1.2	R32 refrigerant	18
2.2	Eco-Desing and Seasonal Efficiency	19
2.2.1	Eco-Design.....	19
2.2.2	Seasonal Efficiency.....	19
2.2.3	Energy classes and energy label (Lot 10).....	20
2.3	General features and benefits of the UTOPIA Prime / UTOPIA IVX Prime Series.....	22
2.3.1	Main features.....	22
2.4	Selection benefits.....	24
2.4.1	Wide range of UTOPIA outdoor units.....	24
2.4.2	Wide range of indoor units combinable with UTOPIA Prime and UTOPIA IVX Prime.....	25
2.5	Installation benefits.....	26
2.6	Start-up benefits.....	27
2.6.1	Automatic start-up test.....	27
2.6.2	Service verification	28
2.7	Maintenance benefits	29
2.7.1	Availability of maintenance tools	29
2.7.2	Simple maintenance.....	29

2.1 Features and benefits

2.1.1 Improvements of UTOPIA Prime / UTOPIA IVX Prime Series

UTOPIA Prime and UTOPIA IVX Prime series provides the following improvements to air conditioning installations:

- 1 Changing the compressor from scroll to advanced rotary.
- 2 Increased working range, in heating mode up to 24/18 °C (DB/WB).
- 3 Increased working range, in cooling mode for the OU simultaneous operation mode up to -15 °C.
- 4 External static pressure increases up to 30Pa.
- 5 Use of R32 refrigerant.
- 6 Individual control with R32 refrigerant.
- 7 Improvements in pipeline limitations. Fewer piping restrictions than in previous series.
- 8 Better efficiency than the previous series.

2.1.2 R32 refrigerant

R32 refrigerant has many benefits over R410A refrigerant.

Although both are “fluorinated greenhouse gases covered by the Kyoto protocol”, R32 has a much lower global warming potential (GWP=675) vs R410A (GWP=2088). This means that it has a lower TnCO₂ equivalence, as a much lower charge is required to obtain better performance due to its better thermodynamic characteristics.

An other advantage of the R32 over the R410A is its greater ease of recovery and reuse, taking into account that its installation and maintenance are very similar.

In short, the R32 reduces its environmental impact, being much more respectful of the ozone layer and with a low GWP. In addition, the use of R32 over R410A allows a refrigerant charge reduction of 7-12% for the same installation.

2.2 Eco-Desing and Seasonal Efficiency

To respond to the European Environmental Objectives of the 3 x 20 (-20% energy consumption, -20% CO2 emission, +20% renewable energy) within 2020, Europe revised the original Ecodesign Directive (Directive 2005/32/CE) and enlarged the applications covered. Initially the scope of Eco-Design was products using energy (E.u.P.). From now on, the scope of Eco-Design will be all products related to energy reduction (ex: air conditioning, windows...) and is called ErP (Energy related Products).

2.2.1 Eco-Design

The Eco-Design of Energy-related products (ErP) Directive provides consistent EU-wide rules for improving the environmental performance of energy related products (ErP) by requiring integration of eco considerations at the outset of product design – ensuring reduced energy consumption to benefit both businesses and consumers. It implies a consideration of the environmental aspect of any products or services developed. This approach consists of qualifying 'CO2 emission' and 'energy consumption' during the whole life of the product (from design to the end life, including transport).

Eco-Design analyses highlighted the fact that the major environmental impact is related to the "usage period" of the above products. For this reason, ErP fixes minimum performance levels to allow products coming in the European market. Simultaneously, ErP fixes technical communication contents to end user through a label (data on performance, sound level) in order to help them to make their choice.

ErP is applied to all air conditioning and heating equipment, whatever the type (air/air, air/water, water/water, boilers...), the capacity, the usage (heating, cooling, SHW) is, through different "Lots" and at different application frameworks. The first one, coming into application on 1st January 2013, was "Lot 10". It does concern all air conditioning systems (air/air), with a capacity lower than 12kw, operating in heating and/or cooling mode.

These regulations include air conditioning products, which are a key source of energy consumption in buildings, and require all manufacturers to calculate energy usage in a more realistic way, moving from nominal to seasonal, creating a more accurate calculation and representation of products in the market.

Key issues in terms of compliance are:

- (a) Fixing a minimum level of performance in heating and cooling mode
- (b) Fixing a maximum sound power level for indoor and outdoor units
- (c) Fixing communication of above characteristics to end users through labelling

Hitachi has always engineered the most environmentally-friendly heating and cooling products from its factories, and is proud to launch a complete range of fully ErP-compliant air conditioning products. Where product ranges and models fall outside the scope of the ErP directive (<12kW), there are a series of enhancements for RAC; in particular UTOPIA Series, which already are market leaders in Japan's Annual Performance Factor (APF) for seasonal efficiency.

2.2.2 Seasonal Efficiency

Seasonal Efficiency has been developed in the Eco Design Directive (EU's Energy Related Products Directive), which specifies the minimum requirements that manufacturers must integrate into their energy using products.

Target relies on a seasonal performance of the equipment called SCOP (heating mode) and SEER (cooling mode) for an average European climate. This performance value will replace historical nominal values of COP and EER.

The new calculation uses several rating temperatures for cooling and heating, and integrates partial capacity operation in the calculation. Since most systems operate most of the time under a partial load, the new methodology gives a better indication of expected real-life performance. The new seasonal efficiency calculation will also take into consideration the power consumed by devices in auxiliary modes like standby mode.

Seasonal Energy Efficiency Ratio (SEER) in cooling and the **Seasonal Coefficient of Performance (SCOP)** in heating give a more accurate estimation of the real performance of the equipment during the whole period of usage, all while considering:

- Several points of measure (In cooling mode: an outside temperature of 20°C, 25°C, 30°C and 35°C; in heating mode: an outside temperature of +12°C, +7°C, +2°C, and -7°C).
- Different compressor speeds (full load and partial load), auxiliary consumption (crankcase heaters, thermostat off mode, OFF mode...).
- Conditions of temperature (number of hours per outdoor temperature) for an identified climate (average climate for ErP compliance)
- Building heat load (called Pdesign)

Hitachi, in compliance with the Eco Design Directive, has developed the new outdoor units: new UTOPIA series, whose high efficiency level (including SEER and SCOP values) is properly informed to our customers to allow for an easy selection.

New UTOPIA series offer high seasonal efficiencies, as well as complete flexibility, with all outdoor units from both ranges being fully compatible with the System Free range of indoor units. Hitachi's UTOPIA technology has all the benefits of VRF, including individual control of each indoor unit with an increased number of indoor unit combinations in addition to delivering excellent part-load efficiency.

With cooling capacities and heating capacities from 2HP to 12HP, a maximum of 4 indoor units are connectable to a single outdoor unit, with individual control and efficiencies achieved as high as A++/A+ (depending on model/ combinations).

2.2.3 Energy classes and energy label (Lot 10)

The **energy efficiency** classes from A+++ to D are introduced based on SCOP and SEER values: The scale for energy labelling is:

A+++	SEER \geq 8,50	SCOP \geq 5,10
A++	6,10 \leq SEER < 8,50	4,60 \leq SCOP < 5,10
A+	5,60 \leq SEER < 6,10	4,00 \leq SCOP < 4,60
A	5,10 \leq SEER < 5,60	3,40 \leq SCOP < 4,00
B	4,60 \leq SEER < 5,10	3,10 \leq SCOP < 3,40
C	4,10 \leq SEER < 4,60	2,80 \leq SCOP < 3,10
D	3,60 \leq SEER < 4,10	2,50 \leq SCOP < 2,80
E	3,10 \leq SEER < 3,60	2,20 \leq SCOP < 2,50
F	2,60 \leq SEER < 3,10	1,90 \leq SCOP < 2,20
G	SEER < 2,60	SCOP < 1,90

The **Energy label** is the regulation compliant way of displaying product efficiency and sound level to any point of sales. This label displays 3 European climates: average climate (green), cold climate (blue), hot climate (orange). Regulation requirement is to display any information related to performances on average climate.

Climate used on ErP	Temperature used for product selection
Average	-10°C
Cold	-22°C
Hot	+2

Energy efficiency label for air conditioners up to 12 kW is supplied together with Hitachi UTOPIA units in order to facilitate our customers their decision when purchasing. Below there is a description of each information that will be found in the energy label.

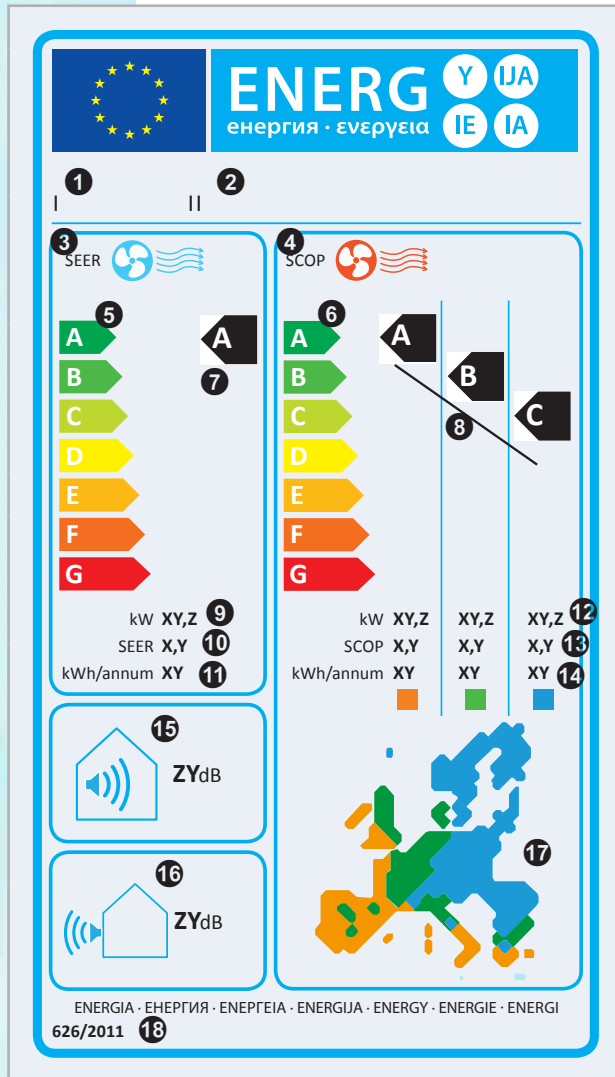

1	Manufacturer
2	Unit name
3	SEER (Seasonal Energy Efficiency) value in cooling mode
4	SCOP (Seasonal Coefficient of performance) value in heating mode
5	Energy efficiency classes SEER in cooling mode
6	Energy efficiency classes SCOP in heating mode
7	Energy efficiency class in cooling of the unit
8	Energy efficiency class in heating of the unit (the indication for the unit model is made for all three climate zones)
9	Nominal capacity in cooling mode
10	SEER value
11	Annual power consumption for cooling
12	Nominal capacity in the heating mode
13	SCOP value
14	Annual power consumption for heating
15	Operating noise for indoors (1)
16	Operating noise for outdoors (1)
17	Climate zones: Warm zone (Athens) (Orange) Moderate zone (Strasbourg) (Green) Cold zone (Helsinki) (Blue)
18	Time reference

(1) Maximally admissible			
Cooling capacity ≤ 6 kW		Cooling capacity > 6 kW ≤ 12 kW	
Indoor unit	Outdoor unit	Indoor unit	Outdoor unit
60 dB(A)	65 dB(A)	65 dB(A)	70 dB(A)

2

2.3 General features and benefits of the UTOPIA Prime / UTOPIA IVX Prime Series

- 1 Connected capacity ratio of Indoor Units from 90% up to 115% (from 90% up to 100% for 3HP).
- 2 Connection of up to 4 Indoor Units (depending on the models).
- 3 Compliance with Eco Design (ErP) and Energy Labelling (ELD) directives about seasonal energy performance:
 - ErP 206/2012&ELD (626/2011) for models up to 12kW of Cooling capacity.
 - ErP 2016/2281 for models higher than 12kW of Cooling capacity.
- 4 Minimum connectable capacity of Indoor Units as low as 0.8HP.

2.3.1 Main features

The number of the indoor units connectable to one outdoor units is:

HP	Maximum number of connectable indoor units
3	2
4	4
5	4
6	4

i NOTE

Please check chapter 4.1 [Combinability range](#).

				
	Outdoor unit model			
	3 HP	4 HP	5 HP	6 HP
Maximum number of connected indoor units	2	4		
Connected capacity ratio of indoor unit % (number of connected Indoor Units)	90-100% (1 or 2 units)	90-115% (1 to 4 units)		
Minimum capacity of indoor units (HP)	0.8			

i NOTE

Where the parameters of installation are close to their limit values (long indoor-to-indoor pipe distances, high outdoor-to-indoor height difference, long pipes in general, etc) it is recommended to follow table for best comfort (see chapter 4.1.2 [Connected capacity ratio](#))

Indoor unit with the highest capacity (HP)	0.8	1.0	1.3	1.5	1.8	2.0	2.3	2.5	3.0	4.0	5.0	6.0
Indoor unit with the lowest capacity (HP)	0.8		1.0			1.3		1.5		1.8		2.0

◆ Easy installation work

Multiple indoor units can be connected to one outdoor unit. As a result, piping and wiring work becomes as easy as when arranging just one refrigerant system. The installation work is made easier and with a shorter schedule, in comparison with the single type where an outdoor unit is required for each indoor unit.

Easy and shortened installation schedule become possible because four indoor units can be connected to one refrigerant system.

This helps to save more installation space and so increases flexibility in installation location.

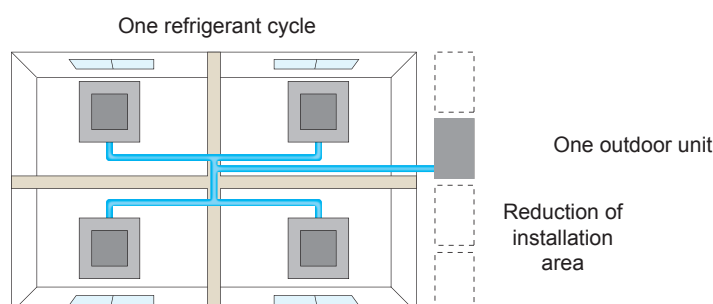

◆ Simultaneous operation on several indoor units for more homogeneous climatization in large open spaces

With UTOPIA Prime is possible for several indoor units connected to a same outdoor unit to operate with the same operation parameters and setting temperature, as it was a single indoor unit.

All indoor units are at the same Thermo-ON or Thermo-OFF status.

Simultaneous operation improves comfort versus monosplit PAC applications by providing a better air homogeneity due to the bigger number of indoor units (up to 4), which means a less centralized air flow. Compared versus another alternatives as multisplits provides longer piping distances needed for tertiary applications; compared to mini VRF systems it is a more cost efficient solution.

Example for common room (Simultaneous operation).

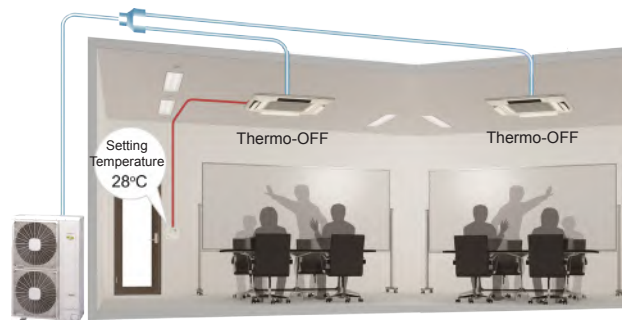

◆ Reduction of local temperature irregularity and achievement of optimal room conditions

With UTOPIA IVX Prime range it is possible a individual thermo-ON/OFF control, enabling control of multiple indoor units by one remote control switch. The air conditioning operation is adjusted to control the room temperature as appropriate, according to the different air-conditioning loads required for the interior zone and the perimeter zone of each room. As a result, this function provides comfortable air conditioning (achieving uniform temperatures) and energy-saving.

- Interior Zone: a zone where temperature is not affected by direct sunlight or outdoor air inflow
- Perimeter Zone: a zone where temperature is affected by direct sunlight or outdoor air inflow

Example for one room (Individual operation with one remote control and operating cable for remote control):

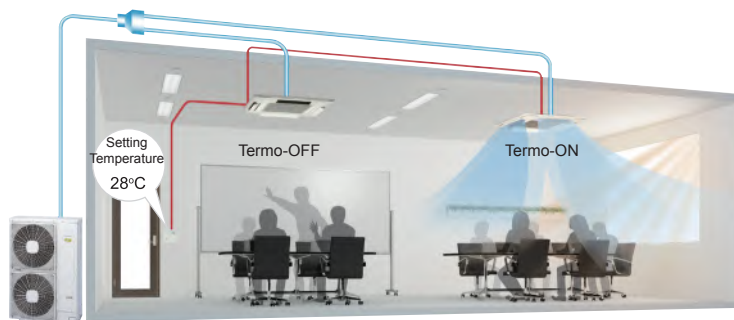

◆ Easy rearrangement for individual rooms

With UTOPIA IVX Prime range a multiple indoor units can be installed and operated individually even if rooms are partitioned. Individual operation can be controlled for each room by connecting the remote control switch to each indoor unit. It is possible to operate the indoor units of occupied rooms only, resulting in energy saving and flexibility for rearrangement of partitions.

Example for multiple rooms (Individual operation).

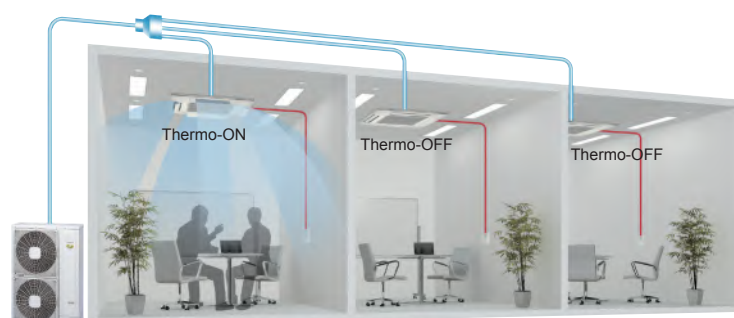

Selection benefits

◆ **Basic combinations (Example of 2 indoor units system)**

	UTOPIA IVX Prime		UTOPIA Prime	
Tset (Setting)	Individual setting	All Indoor units same setting	All Indoor units same setting	All Indoor units same setting
Running ON/OFF (indoor unit)	Individually	Simultaneously	Simultaneously	Simultaneously
Thermo-ON/OFF	Individually	Individually (both indoor units linked to same Tset)	Simultaneously (all units Thermo-ON if none of them reached Tset)	Simultaneously (all units Thermo-ON if none of them reached Tset)
Optional functions setting	Individually	Individually	Simultaneously All units same setting	Individually
Application (examples)	Multiple rooms	Large open space with non homogeneous load demand Multiple rooms with same Tset	Large open space	Large open space

◆ **Flexible combinations for Individual Operation (Combination example by using Individual Operation Function)**

These configurations are to be used with UTOPIA IVX Prime.

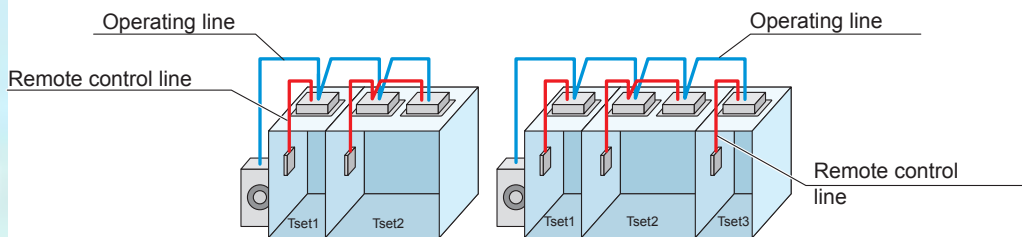

Flexible combinations are realized by using the remote control switches

◆ **Decreased defrosting operation time and extended heating operation time by control depending on amount of frost**

The amount of frost can be estimated from the length of last defrosting. If the amount of frost is less than the last time, then heating operation until next defrosting operation is extended automatically. As a result, unnecessary defrosting operation is avoided, increasing availability of continuous heating operation.

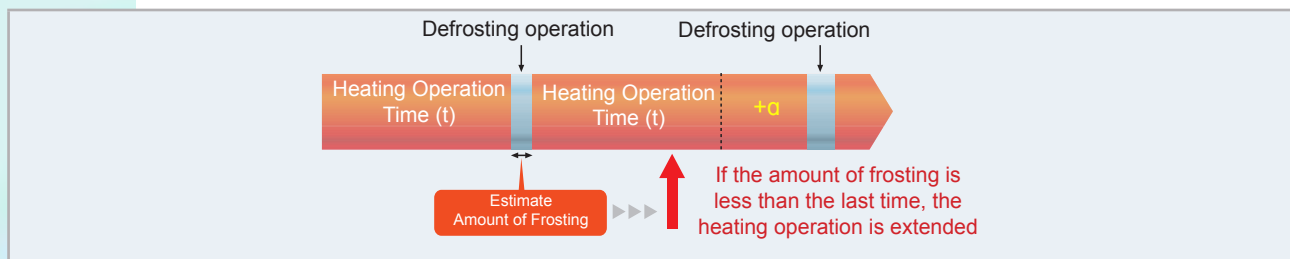











2.4 Selection benefits

2.4.1 Wide range of UTOPIA outdoor units

Series	Power Supply	3HP	4HP	5HP	6HP
UTOPIA Prime / UTOPIA IVX Prime R32 RAS-H(V)R(C/P)2E	1~ 230V 50Hz	●	●	●	●
	3N~ 400V 50Hz		●	●	●
UTOPIA Prime / UTOPIA IVX Prime R410A RAS-H(V)N(C/P)2E	1~ 230V 50Hz		●	●	●
	3N~ 400V 50Hz		●	●	●

2.4.2 Wide range of indoor units combinable with UTOPIA Prime and UTOPIA IVX Prime

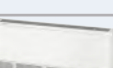
Hitachi indoor units have a wide range of capacities from 0.8 to 6.0 HP.

Model		SYSTEM FREE											
		Capacity (HP)											
		0.8	1.0	1.3	1.5	1.8	2.0	2.3	2.5	3.0	4.0	5.0	6.0
RCI-FSR 4-way cassette			●	●	●	●	●	●	●	●	●	●	●
RCIM-FSR 4-way cassette (compact)		●	●	●	●	●	●	●	●				
RCD-FSR 2-way cassette		●	●	●	●	●	●	●	●	●	●	●	●
RPC-FSR Ceiling type				●	●	●	●	●	●	●	●	●	●
RPIL-FSRE Indoor ducted unit (slim)		●	●		●								
RPI-FSRE Indoor ducted unit (Medium external static pressure)					●		●		●	●	●	●	●
RPIH-FSRE Indoor ducted unit (High external static pressure)											●	●	●
RPI-FSN6E-EF Indoor ducted unit for Econofresh											●	●	●
RPK-FSR(H)M Wall type		●	●	●	●	●	●	●	●	●	●		
RPF-FSN2E Floor type			●	●	●	●	●	●	●				
RPFI-FSN2E Floor concealed type			●	●	●	●	●	●	●				

- Constant capacity unit.
- Unit whose capacity can be set one step lower, marked with ●, using the DIP switch.
- Unit whose capacity can be set one step higher, marked with ●, using the DIP switch.

2.5 Installation benefits

◆ H-Link II bus

Easy connection

The communication bus is formed by a pair of small-diameter cores with no specific polarity. Given that no multi-way communication cables are used, the installation is simple, fast and effective. The connections cannot be confused.

The two-core non-polarity communication bus provides significant savings in terms of materials and installation, as the same cable is used for all the units and is quickly and simply connected directly to them.

Long distance

The total length of the communication bus between all the units can reach 1000 m. If the communication line must be longer (e.g. to expand the air conditioning system or to manage the units from a unified station in the building), the total distance can be extended to 5000 m by using the accessories available.

Auto-configuration of system units

The air conditioning system control systems are auto-configuring. They recognise the type of unit they are connected to, along with the type of indoor unit and its capacity. The installation is started quickly and efficiently.

It is also possible to configure all units manually to adjust the installation in line with personalised parameters.

Up to 160 units connected together in a single H-LINK II bus line

It is possible to connect up to 160 indoor units and up to 64 refrigerant cycles from the SYSTEM FREE range in a single H-LINK II bus line. To expand the installation or increase the bus lines available, simply add a new line.

All units are managed as one through the control systems installed.

Example of the H-LINK II system:

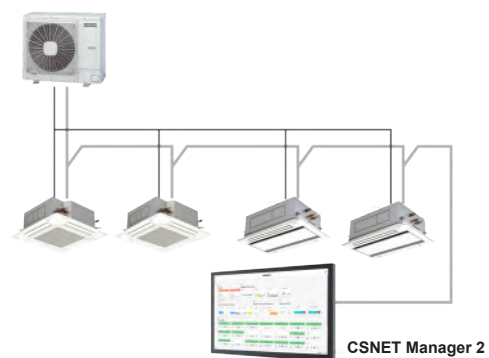

Specifications	
Transmission cable:	2 conductors
Transmission cable polarity:	No polarity
Maximum number of outdoor units connected:	64 units per H-LINK II system
Maximum number of indoor units connected:	160 units per H-LINK II system
Maximum number of devices:	200
Maximum wiring length:	Total 1000 m (5000 m (*))
Recommended cable:	Shielded twisted pair cable or shielded pair cable over 0.75 mm ² (equivalent to KPEV-S)
Voltage:	5 V DC



NOTE

- When the H-LINK II bus is used, the DIP switches must be adjusted. Otherwise, or if incorrectly adjusted, a transmission problem may occur.
- The H-LINK II system offers great flexibility for the design of air conditioning systems, as installation is simple and the total cost affordable. Furthermore, centralised management is possible by connecting the CSNET Manager 2 system to the H-LINK II network cables.
- Additionally, it is possible to manage the installation over the internet using the CSNET Manager 2.
- (*) Using 4 H-LINK relays PSC-5HR (sold separately as an option).

No need for remote control relay wiring in UTOPIA Prime

In the case of UTOPIA Prime systems comprising several indoor units (up to 4 indoor units), indoor units can be controlled from a single remote controller, without the need to link them up with dedicated remote control relay wiring.

A: Service cable.

B: Dedicated cable for remote control relay, not required when units are set to simultaneous operation.

The indoor units must be H-LINK II-compatible models.

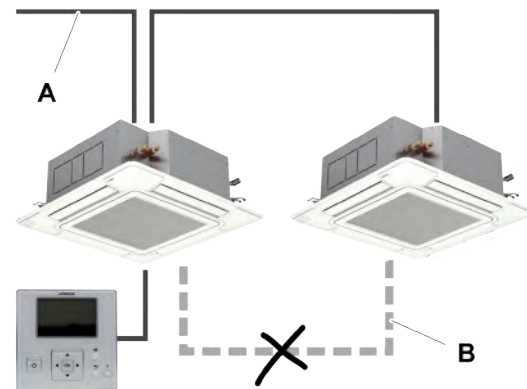

2.6 Start-up benefits

2.6.1 Automatic start-up test

The installation is started up automatically, therefore considerably reducing the time required for the process.

There are the following types of start-up:

- Test run and identification of the units forming the system.
- Test run from the remote control.
- Test run from the outdoor unit.

◆ Test run and identification of the system units

The test run can be carried out from either the rotating DIP switches on the outdoor unit or from the remote control for the indoor unit.

The seven-segment indicator on the outdoor unit provides all of the information required to check the system is operating properly.

The units forming part of the system are identified separately for the outdoor and indoor units:

- Outdoor units: the remote control can be used to allocate the series to which the operational outdoor units belong (e.g. single or multiple series).
- Indoor units: using the rotating DIP switch on each unit.

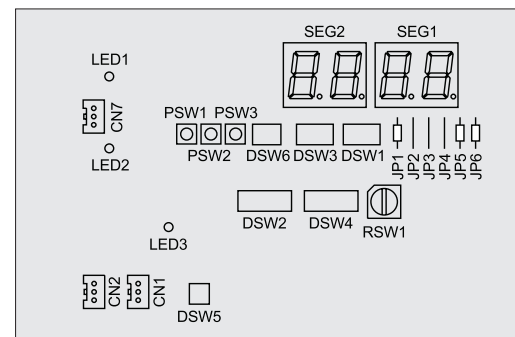

◆ Test run from the remote control

Three operations for the test run are possible from the remote control:

- 1 Auto-diagnostic: quick check of the operating conditions of the indoor units and outdoor unit.
- 2 Data memory query: in the event of an alarm, the remote control saves all the operating parameters of the unit at that particular time and the screen displays the corresponding fault code. The air conditioning system diagnostic is simple and effective.
- 3 Optional function setting: the remote control is able to make settings on up to 29 possible options, such as the four-degree offset in heating mode or the increase in fan speed. It is possible to set several indoor units at the same time and to modify the unit configuration once installation is complete.



◆ Test run from the outdoor unit

The seven-segment indicator on the outdoor unit displays parameters relating to its working order. Any incident arising during start-up or normal operation can be diagnosed from the indicator.

2.6.2 Service verification

◆ System operation control

The working order of the system is continuously monitored through the control system. All operating parameters that the system uses to manage the outdoor and indoor units are continuously supervised.

◆ Assisted-management air conditioning system

The air conditioning system can be conveniently managed using the Hitachi Service Tools assisted-management software.

This software allows for a laptop, for example, to be connected to the air conditioning system via an interface connected to the H-LINK II bus. Through different menus, the software effectively manages all of the systems connected and obtains data for optimised system performance.

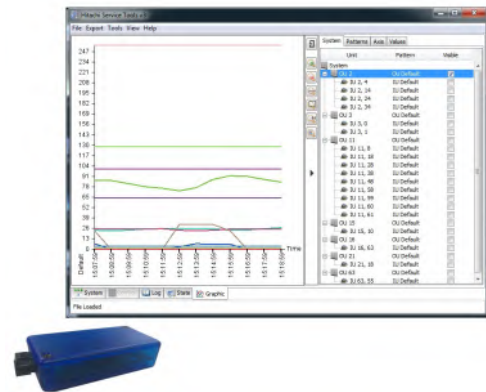

All of the data obtained using Hitachi Service Tools is collected in different formats and monitored in several ways. The software user can configure the processing of the data to monitor the parameters of most interest in each installation and allows reporting of the logged data, exporting each of its screens in different ways.

The data reports can be used to continuously check the correct working order of the system. Any deviation in the ranges of foreseen values is immediately detected.

Additionally, Service Tools adds the option to control the units remotely, helping the user to evolve its test without moving away of his computer and it is possible to configure its optional functions from Service Tools without the need to perform further setup on each unit.

Service Tools can be updated online using an internet connection. If properly configured and registered, Service Tools will check for new updates and advise the user to download them.

2.7 Maintenance benefits

2.7.1 Availability of maintenance tools

◆ Hitachi Service Tools

All of the functions of the Hitachi Service Tools software can also be used for unit maintenance (preventive or corrective). Any incident can be quickly detected and solved in a shorter time.

The CSNET WEB system is also a powerful tool that is extremely useful for maintenance work.

Hitachi has a range of different remote control systems that can be used with the SET FREE and UTOPIA outdoor units. Consult the corresponding Technical Catalogue for controls.



◆ Monitoring the system and simplifying maintenance work

The Hitachi Service Tools software is a very powerful tool for the control and management of air conditioning installations. To do so, it supervises the working order of the entire system and displays data that allows for potential incidents to be detected.

Management via software improves the advanced scheduling of planned technical stoppages and means that any unit can be inspected without altering the operation of the air conditioning system. The data obtained is processed and interpreted directly by the software, without the need to waste time or personnel on data reading or on-site checks.

◆ Decrease in operation costs

Monitored operation allows for real-time observation of the performance of the entire air conditioning system. The control system is responsible for ensuring all parts work according to the foreseen conditions, with the maximum performance and efficiency at all times. In this situation, the utmost benefit is obtained from the entire installation at minimum operation costs.

Any range of values tending to be outside that foreseen is an indication of a situation that must be corrected as quickly as possible. The management software clearly displays situations of this type and, therefore, is an interesting ally for reducing costs generated by extraordinary maintenance stoppages.

The more in-depth analysis of the tendencies offers a starting point for realistic maintenance schedules, adapted to the operating conditions of each system.

2.7.2 Simple maintenance

◆ Optimised design to simplify maintenance

The components of the indoor units of the entire range have a strong, long-lasting design bearing in mind the demanding requirements of the market insofar as maintenance cost reduction.

The interior structure of the units and the layout of the internal parts make any removal and assembly operations easier where technical work is required for some reason.

◆ Minimum or zero maintenance

All units and components of the UTOPIA range of outdoor units have been designed for simple, easy maintenance operations.

◆ Absence of replacement consumable

Parts subject to inspection are practically inexistent throughout the range. On some specific models, only the regular long-term replacement of the air and deodorising filters is required. Consumable or replacement parts are not required.

◆ Loyal to the Hitachi philosophy

The outdoor units of the UTOPIA range have been designed in line with Hitachi philosophy to guarantee the highest reliability and reduce maintenance work to an essential minimum.

3. General data

Index

3.1	General information.....	32
3.2	General specifications.....	33
3.3	Cooling and heating performance	41
3.3.1	UTOPIA Prime single phase series	41
3.3.2	UTOPIA IVX Prime single phase series	41
3.3.3	UTOPIA Prime three phase series	42
3.3.4	UTOPIA IVX Prime three phase series	42
3.4	Component data.....	43
3.5	Electrical data.....	45
3.5.1	UTOPIA series.....	46



3.1 General information

◆ Combination with indoor units and complementary systems

All the UTOPIA Prime and UTOPIA IVX Prime described in this Technical Catalogue can be combined with the indoor units indicated in the following table:

IU \ OU		UTOPIA Prime and UTOPIA IVX Prime	
		R32	R410A
		RAS-3HVRC2 RAS-(4-6)H(V)R(C/P)2E	RAS-(4-6)H(V)N(C/P)2E
New series	RCI-FSR	✓	✓
	RCIM-FSRE (*)	✓	✓
	RCD-FSR	✓	✓
	RPC-FSR	✓	✓
	RPIL-FSRE (*)	✓	✓
	RPI-FSRE	✓	✓
	RPIH-FSRE	✓	✓
	RPK-FSR(H)M (*)	✓	✓
	RPI-4.0FSN6E-EF	✗	✓
Previous series	RCI-FSN4	✗	✓
	RCIM-FSN4E (*)	✗	✓
	RCD-FSN3	✗	✓
	RPC-FSN3	✗	✓
	RPI-FSN5E (*)	✗	✓
	RPIM-FSN4E(DU) (*)	✗	✓
	RPK-FSN(H)4M (*)	✗	✓
	RPF-FSN2E	✗	✓
	RPFI-FSN2E	✗	✓
	KPI-E4E	✓	✓
	KPI-X4E	✗	✓
	EXV-E2	✗	✓

NOTE

- For older OU series, contact Hitachi CSC.
- (*): The minimum capacity of indoor units that can be used in combination with R32 and R410A UTOPIA Prime and UTOPIA IVX Prime series is 0.8HP.

3.2 General specifications

◆ UTOPIA Prime with R32 refrigerant for single phase units

OUTDOOR UNITS		RAS-3HVRC2	RAS-4HVRC2E	RAS-5HVRC2E	RAS-6HVRC2E
Power supply	-	1~ 230V 50Hz	1~ 230V 50Hz	1~ 230V 50Hz	1~ 230V 50Hz
Nominal cooling capacity	kW	7.1	10.0	11.9	14.0
Nominal heating capacity	kW	8	11.2	14.0	16.0
Minimum - Maximum connectable indoor units	-	1 - 2	1 - 4	1 - 4	1 - 4
Minimum - Maximum connected capacity	%	90% - 100%	90% - 115%	90% - 115%	90% - 115%
Noise level cooling (sound pressure) (night mode)	dB(A)	54 (48)	54 (51)	54 (51)	56 (51)
Noise level heating (sound pressure)	dB(A)	52	54	54	56
Noise level (sound power)	dB(A)	69	70	70	72
Air flow (cooling / heating)	m ³ /min	45	80	80	80
Dimensions (H x W x D)	mm	629 x 799(+95) x 300	1140 x 950 x 370	1140 x 950 x 370	1140 x 950 x 370
Net weight	kg	48	84	84	84
Recommended circuit breaker	A	20	25	25	25
Maximum current	A	15.8	22.5	22.5	22.5
Running current cooling	A	7.6	12.4	16.3	21.1
Running current heating	A	8.1	12.8	17.0	17.6
Size of power cable (according to EN 60335-1)	quantity x mm ²	3 x 4.0	3 x 6.0	3 x 6.0	3 x 6.0
Size of transmission cable between indoor unit and outdoor unit	quantity x mm ²	2 x 0.75	2 x 0.75	2 x 0.75	2 x 0.75
Piping diameter (liquid / gas)	mm (inch)	Ø9.52 (3/8) / Ø15.88 (5/8)	Ø9.52 (3/8) / Ø15.88 (5/8)	Ø9.52 (3/8) / Ø15.88 (5/8)	Ø9.52 (3/8) / Ø15.88 (5/8)
Minimum piping length	m	5	5	5	5
Maximum piping length (chargeless)	m	20	20	20	20
Maximum piping length	m	50	75	75	75
Height difference (higher OU / lower OU)	m	30 / 20	30 / 20	30 / 20	30 / 20
Refrigerant	-	R32	R32	R32	R32
Refrigerant charge before shipment	kg	1.7	3	3	3
Additional refrigerant charge needed	g/m	45	45	45	45
Compressor type	-	Rotative DC Inverter driven	Rotative DC Inverter driven	Rotative DC Inverter driven	Rotative DC Inverter driven

◆ **UTOPIA Prime with R32 refrigerant for three phase units**

OUTDOOR UNITS		RAS-4HRC2E	RAS-5HRC2E	RAS-6HRC2E
Power supply	-	3N~ 400V 50Hz	3N~ 400V 50Hz	3N~ 400V 50Hz
Nominal cooling capacity	kW	10.0	11.9	14.0
Nominal heating capacity	kW	11.2	14.0	16.0
Minimum - Maximum connectable indoor units	-	1 - 4	1 - 4	1 - 4
Minimum - Maximum connected capacity	%	90% - 115%	90% - 115%	90% - 115%
Noise level cooling (sound pressure) (night mode)	dB(A)	54 (51)	54 (51)	56 (51)
Noise level heating (sound pressure)	dB(A)	54	54	56
Noise level (sound power)	dB(A)	70	70	72
Air flow (cooling / heating)	m ³ /min	80	80	80
Dimensions (H x W x D)	mm	1140 x 950 x 370	1140 x 950 x 370	1140 x 950 x 370
Net weight	kg	86	86	86
Recommended circuit breaker	A	20	20	20
Maximum current	A	15	15	15
Running current cooling	A	4.4	5.7	7.4
Running current heating	A	4.5	6.0	6.2
Size of power cable (according to EN 60335-1)	quantity x mm ²	5 x 4.0	5 x 4.0	5 x 4.0
Size of transmission cable between indoor unit and outdoor unit	quantity x mm ²	2 x 0.75	2 x 0.75	2 x 0.75
Piping diameter (liquid / gas)	mm (inch)	Ø9.52 (3/8) / Ø15.88 (5/8)	Ø9.52 (3/8) / Ø15.88 (5/8)	Ø9.52 (3/8) / Ø15.88 (5/8)
Minimum piping length	m	5	5	5
Maximum piping length (chargeless)	m	20	20	20
Maximum piping length	m	75	75	75
Height difference (higher OU / lower OU)	m	30 / 20	30 / 20	30 / 20
Refrigerant	-	R32	R32	R32
Refrigerant charge before shipment	kg	3	3	3
Additional refrigerant charge needed	g/m	45	45	45
Compressor type	-	Rotative DC Inverter driven	Rotative DC Inverter driven	Rotative DC Inverter driven

◆ **UTOPIA Prime with R410A refrigerant for single phase units**

OUTDOOR UNITS		RAS-4HVNC2E	RAS-5HVNC2E	RAS-6HVNC2E
Power supply	-	1~ 230V 50Hz	1~ 230V 50Hz	1~ 230V 50Hz
Nominal cooling capacity	kW	10.0	11.9	14.0
Nominal heating capacity	kW	11.2	14.0	16.0
Minimum - Maximum connectable indoor units	-	1 - 4	1 - 4	1 - 4
Minimum - Maximum connected capacity	%	90% - 115%	90% - 115%	90% - 115%
Noise level cooling (sound pressure) (night mode)	dB(A)	54 (51)	54 (51)	56 (51)
Noise level heating (sound pressure)	dB(A)	54	54	56
Noise level (sound power)	dB(A)	70	70	72
Air flow (cooling / heating)	m ³ /min	80	80	80
Dimensions (H x W x D)	mm	1140 x 950 x 370	1140 x 950 x 370	1140 x 950 x 370
Net weight	kg	84	84	84
Recommended circuit breaker	A	25	25	25
Maximum current	A	22.5	22.5	22.5
Running current cooling	A	13.8	18.3	23.7
Running current heating	A	12.6	17.0	17.6
Size of power cable (according to EN 60335-1)	quantity x mm ²	3 x 6.0	3 x 6.0	3 x 6.0
Size of transmission cable between indoor unit and outdoor unit	quantity x mm ²	2 x 0.75	2 x 0.75	2 x 0.75
Piping diameter (liquid / gas)	mm (inch)	Ø9.52 (3/8) / Ø15.88 (5/8)	Ø9.52 (3/8) / Ø15.88 (5/8)	Ø9.52 (3/8) / Ø15.88 (5/8)
Minimum piping length	m	5	5	5
Maximum piping length (chargeless)	m	20	20	20
Maximum piping length	m	75	75	75
Height difference (higher OU / lower OU)	m	30 / 20	30 / 20	30 / 20
Refrigerant	-	R410A	R410A	R410A
Refrigerant charge before shipment	kg	3.2	3.2	3.2
Additional refrigerant charge needed	g/m	60	60	60
Compressor type	-	Rotative DC Inverter driven	Rotative DC Inverter driven	Rotative DC Inverter driven

◆ **UTOPIA Prime with R410A refrigerant for three phase units**

OUTDOOR UNITS		RAS-4HNC2E	RAS-5HNC2E	RAS-6HNC2E
Power supply	-	3N~ 400V 50Hz	3N~ 400V 50Hz	3N~ 400V 50Hz
Nominal cooling capacity	kW	10.0	11.9	14.0
Nominal heating capacity	kW	11.2	14.0	16.0
Minimum - Maximum connectable indoor units	-	1 - 4	1 - 4	1 - 4
Minimum - Maximum connected capacity	%	90% - 115%	90% - 115%	90% - 115%
Noise level cooling (sound pressure) (night mode)	dB(A)	54 (51)	54 (51)	56 (51)
Noise level heating (sound pressure)	dB(A)	54	54	56
Noise level (sound power)	dB(A)	70	70	72
Air flow (cooling / heating)	m ³ /min	80	80	80
Dimensions (H x W x D)	mm	1140 x 950 x 370	1140 x 950 x 370	1140 x 950 x 370
Net weight	kg	86	86	86
Recommended circuit breaker	A	20	20	20
Maximum current	A	15	15	15
Running current cooling	A	4.9	6.4	8.3
Running current heating	A	4.4	6.0	6.2
Size of power cable (according to EN 60335-1)	quantity x mm ²	5 x 4.0	5 x 4.0	5 x 4.0
Size of transmission cable between indoor unit and outdoor unit	quantity x mm ²	2 x 0.75	2 x 0.75	2 x 0.75
Piping diameter (liquid / gas)	mm (inch)	Ø9.52 (3/8) / Ø15.88 (5/8)	Ø9.52 (3/8) / Ø15.88 (5/8)	Ø9.52 (3/8) / Ø15.88 (5/8)
Minimum piping length	m	5	5	5
Maximum piping length (chargeless)	m	20	20	20
Maximum piping length	m	75	75	75
Height difference (higher OU / lower OU)	m	30 / 20	30 / 20	30 / 20
Refrigerant	-	R410A	R410A	R410A
Refrigerant charge before shipment	kg	3.2	3.2	3.2
Additional refrigerant charge needed	g/m	60	60	60
Compressor type	-	Rotative DC Inverter driven	Rotative DC Inverter driven	Rotative DC Inverter driven

◆ **UTOPIA IVX Prime with R32 refrigerant for single phase units**

OUTDOOR UNITS		RAS-4HVRP2E	RAS-5HVRP2E	RAS-6HVRP2E
Power supply	-	1~ 230V 50Hz	1~ 230V 50Hz	1~ 230V 50Hz
Nominal cooling capacity	kW	10.0	12.5	14.0
Nominal heating capacity	kW	11.2	14.0	16.0
Minimum - Maximum connectable indoor units	-	1 - 4	1 - 4	1 - 4
Minimum - Maximum connected capacity	%	90% - 115%	90% - 115%	90% - 115%
Noise level cooling (sound pressure) (night mode)	dB(A)	54 (51)	56 (51)	56 (51)
Noise level heating (sound pressure)	dB(A)	54	56	56
Noise level (sound power)	dB(A)	70	72	72
Air flow (cooling / heating)	m ³ /min	80	80	80
Dimensions (H x W x D)	mm	1140 x 950 x 370	1140 x 950 x 370	1140 x 950 x 370
Net weight	kg	84	84	84
Recommended circuit breaker	A	25	25	25
Maximum current	A	22.5	22.5	22.5
Running current cooling	A	12.1	16.5	21.1
Running current heating	A	12.6	16.4	17.6
Size of power cable (according to EN 60335-1)	quantity x mm ²	3 x 6.0	3 x 6.0	3 x 6.0
Size of transmission cable between indoor unit and outdoor unit	quantity x mm ²	2 x 0.75	2 x 0.75	2 x 0.75
Piping diameter (liquid / gas)	mm (inch)	Ø9.52 (3/8) / Ø15.88 (5/8)	Ø9.52 (3/8) / Ø15.88 (5/8)	Ø9.52 (3/8) / Ø15.88 (5/8)
Minimum piping length	m	5	5	5
Maximum piping length (chargeless)	m	20	20	20
Maximum piping length	m	75	75	75
Height difference (higher OU / lower OU)	m	30 / 20	30 / 20	30 / 20
Refrigerant	-	R32	R32	R32
Refrigerant charge before shipment	kg	3	3	3
Additional refrigerant charge needed	g/m	45	45	45
Compressor type	-	Rotative DC Inverter driven	Rotative DC Inverter driven	Rotative DC Inverter driven

◆ **UTOPIA IVX Prime with R32 refrigerant for three phase units**

OUTDOOR UNITS		RAS-4HRP2E	RAS-5HRP2E	RAS-6HRP2E
Power supply	-	3N~ 400V 50Hz	3N~ 400V 50Hz	3N~ 400V 50Hz
Nominal cooling capacity	kW	10.0	12.5	14.0
Nominal heating capacity	kW	11.2	14.0	16.0
Minimum - Maximum connectable indoor units	-	1 - 4	1 - 4	1 - 4
Minimum - Maximum connected capacity	%	90% - 115%	90% - 115%	90% - 115%
Noise level cooling (sound pressure) (night mode)	dB(A)	54 (51)	56 (51)	56 (51)
Noise level heating (sound pressure)	dB(A)	54	56	56
Noise level (sound power)	dB(A)	70	72	72
Air flow (cooling / heating)	m ³ /min	80	80	80
Dimensions (H x W x D)	mm	1140 x 950 x 370	1140 x 950 x 370	1140 x 950 x 370
Net weight	kg	86	86	86
Recommended circuit breaker	A	20	20	20
Maximum current	A	15	15	15
Running current cooling	A	4.3	5.8	7.4
Running current heating	A	4.4	5.8	6.2
Size of power cable (according to EN 60335-1)	quantity x mm ²	5 x 4.0	5 x 4.0	5 x 4.0
Size of transmission cable between indoor unit and outdoor unit	quantity x mm ²	2 x 0.75	2 x 0.75	2 x 0.75
Piping diameter (liquid / gas)	mm (inch)	Ø9.52 (3/8) / Ø15.88 (5/8)	Ø9.52 (3/8) / Ø15.88 (5/8)	Ø9.52 (3/8) / Ø15.88 (5/8)
Minimum piping length	m	5	5	5
Maximum piping length (chargeless)	m	20	20	20
Maximum piping length	m	75	75	75
Height difference (higher OU / lower OU)	m	30 / 20	30 / 20	30 / 20
Refrigerant	-	R32	R32	R32
Refrigerant charge before shipment	kg	3	3	3
Additional refrigerant charge needed	g/m	45	45	45
Compressor type	-	Rotative DC Inverter driven	Rotative DC Inverter driven	Rotative DC Inverter driven

◆ **UTOPIA IVX Prime with R410A refrigerant for single phase units**

OUTDOOR UNITS		RAS-4HVNP2E	RAS-5HVNP2E	RAS-6HVNP2E
Power supply	-	1~ 230V 50Hz	1~ 230V 50Hz	1~ 230V 50Hz
Nominal cooling capacity	kW	10.0	12.5	14.0
Nominal heating capacity	kW	11.2	14.0	16.0
Minimum - Maximum connectable indoor units	-	1 - 4	1 - 4	1 - 4
Minimum - Maximum connected capacity	%	90% - 115%	90% - 115%	90% - 115%
Noise level cooling (sound pressure) (night mode)	dB(A)	54 (51)	56 (51)	56 (51)
Noise level heating (sound pressure)	dB(A)	54	56	56
Noise level (sound power)	dB(A)	70	72	72
Air flow (cooling / heating)	m ³ /min	80	80	80
Dimensions (H x W x D)	mm	1140 x 950 x 370	1140 x 950 x 370	1140 x 950 x 370
Net weight	kg	84	84	84
Recommended circuit breaker	A	25	25	25
Maximum current	A	22.5	22.5	22.5
Running current cooling	A	13.6	18.5	23.7
Running current heating	A	12.4	16.4	17.6
Size of power cable (according to EN 60335-1)	quantity x mm ²	3 x 6.0	3 x 6.0	3 x 6.0
Size of transmission cable between indoor unit and outdoor unit	quantity x mm ²	2 x 0.75	2 x 0.75	2 x 0.75
Piping diameter (liquid / gas)	mm (inch)	Ø9.52 (3/8) / Ø15.88 (5/8)	Ø9.52 (3/8) / Ø15.88 (5/8)	Ø9.52 (3/8) / Ø15.88 (5/8)
Minimum piping length	m	5	5	5
Maximum piping length (chargeless)	m	20	20	20
Maximum piping length	m	75	75	75
Height difference (higher OU / lower OU)	m	30 / 20	30 / 20	30 / 20
Refrigerant	-	R410A	R410A	R410A
Refrigerant charge before shipment	kg	3.2	3.2	3.2
Additional refrigerant charge needed	g/m	60	60	60
Compressor type	-	Rotative DC Inverter driven	Rotative DC Inverter driven	Rotative DC Inverter driven

◆ **UTOPIA IVX Prime with R410A refrigerant for three phase units**

OUTDOOR UNITS		RAS-4HNP2E	RAS-5HNP2E	RAS-6HNP2E
Power supply	-	3N~ 400V 50Hz	3N~ 400V 50Hz	3N~ 400V 50Hz
Nominal cooling capacity	kW	10.0	12.5	14.0
Nominal heating capacity	kW	11.2	14.0	16.0
Minimum - Maximum connectable indoor units	-	1 - 4	1 - 4	1 - 4
Minimum - Maximum connected capacity	%	90% - 115%	90% - 115%	90% - 115%
Noise level cooling (sound pressure) (night mode)	dB(A)	54 (51)	56 (51)	56 (51)
Noise level heating (sound pressure)	dB(A)	54	56	56
Noise level (sound power)	dB(A)	70	72	72
Air flow (cooling / heating)	m ³ /min	80	80	80
Dimensions (H x W x D)	mm	1140 x 950 x 370	1140 x 950 x 370	1140 x 950 x 370
Net weight	kg	86	86	86
Recommended circuit breaker	A	20	20	20
Maximum current	A	15	15	15
Running current cooling	A	4.8	6.5	8.3
Running current heating	A	4.3	5.8	6.2
Size of power cable (according to EN 60335-1)	quantity x mm ²	5 x 4.0	5 x 4.0	5 x 4.0
Size of transmission cable between indoor unit and outdoor unit	quantity x mm ²	2 x 0.75	2 x 0.75	2 x 0.75
Piping diameter (liquid / gas)	mm (inch)	Ø9.52 (3/8) / Ø15.88 (5/8)	Ø9.52 (3/8) / Ø15.88 (5/8)	Ø9.52 (3/8) / Ø15.88 (5/8)
Minimum piping length	m	5	5	5
Maximum piping length (chargeless)	m	20	20	20
Maximum piping length	m	75	75	75
Height difference (higher OU / lower OU)	m	30 / 20	30 / 20	30 / 20
Refrigerant	-	R410A	R410A	R410A
Refrigerant charge before shipment	kg	3.2	3.2	3.2
Additional refrigerant charge needed	g/m	60	60	60
Compressor type	-	Rotative DC Inverter driven	Rotative DC Inverter driven	Rotative DC Inverter driven

3.3 Cooling and heating performance

3.3.1 UTOPIA Prime single phase series

System combination			Cooling				Heating				
Refrigerant	Outdoor unit	Indoor unit	SEER	EER	Energy Class	P Design (35°C)	SCOP	COP	Energy Class	P Design (-10°C)	
			-	-	-	kW	-	-	-	kW	
R32	RAS-3HVRC2	RCI-3.0FSR	7.33	3.93	A++	7.10	4.20	4.11	A+	6.00	
		RPI-3.0FSRE	6.70	3.47	A++	7.10	3.92	3.63	A	6.00	
		RPC-3.0FSR	7.02	3.91	A++	7.10	4.09	3.52	A+	6.00	
		RPK-3.0FSR(H)M	7.04	3.37	A++	7.10	3.90	3.01	A	5.60	
	RAS-4HVRC2E	RCI-4.0FSR	6.93	3.90	A++	10.00	4.36	4.23	A+	8.70	
		RPIH-4.0FSRE	7.18	3.73	A++	10.00	4.38	3.73	A+	8.70	
		RPI-4.0FSRE	6.44	3.62	A++	10.00	4.04	3.71	A+	8.70	
		RPC-4.0FSR	5.93	3.47	A+	10.00	4.13	3.47	A+	8.70	
	RAS-5HVRC2E	RCI-5.0FSR	6.60	3.52	A++	11.90	4.26	3.98	A+	11.93	
		RPI(H)-5.0FSRE	7.06	3.37	A++	11.90	4.36	3.52	A+	11.93	
		RPI-5.0FSRE	6.10	3.26	A++	11.90	4.03	3.42	A+	11.93	
		RPC-5.0FSR	6.09	3.06	A+	11.90	4.09	3.21	A+	11.93	
	RAS-6HVRC2E	2 x RCI-3.0FSR	7.35	3.24	-	14.00	4.73	4.40	-	14.20	
		2 x RPI-3.0FSRE	7.30	3.09	-	14.00	4.73	4.40	-	14.20	
	R410A	RAS-4HVNC2E	RCI-4.0FSR	6.69	3.50	A++	10.00	4.40	4.30	A+	8.70
			RPIH-4.0FSRE	6.90	3.33	A++	10.00	4.44	3.79	A+	8.70
RPI-4.0FSRE			6.21	3.24	A++	10.00	4.09	3.71	A+	8.70	
RPC-4.0FSR			5.72	3.10	A+	10.00	4.18	3.53	A+	8.70	
RAS-5HVNC2E		RCI-5.0FSR	6.35	3.15	A++	11.90	4.24	3.98	A+	11.93	
		RPI(H)-5.0FSRE	6.77	3.01	A++	11.90	4.34	3.52	A+	11.93	
		RPI-5.0FSRE	5.87	2.92	A+	11.90	3.93	3.42	A	11.93	
		RPC-5.0FSR	5.86	2.74	A+	11.90	4.09	3.21	A+	11.93	
RAS-6HVNC2E		2 x RCI-3.0FSR	7.01	2.85	-	14.00	4.71	4.40	-	14.20	
		2 x RPI-3.0FSRE	6.99	2.81	-	14.00	4.70	4.40	-	14.20	

3.3.2 UTOPIA IVX Prime single phase series

System combination			Cooling				Heating			
Refrigerant	Outdoor unit	Indoor unit	SEER	EER	Energy Class	P Design (35°C)	SCOP	COP	Energy Class	P Design (-10°C)
			-	-	-	kW	-	-	-	kW
R32	RAS-4HVRP2E	2 x RCI-2.0FSR	7.31	3.98	A++	10.00	4.60	4.31	A++	8.70
		2 x RPI-2.0FSRE	5.94	3.55	A+	10.00	3.91	3.71	A	8.70
	RAS-5HVRP2E	-	8.35	3.66	-	12.50	4.75	4.13	-	11.93
	RAS-6HVRP2E	-	7.35	3.24	-	14.00	4.73	4.40	-	14.20
R410A	RAS-4HVNP2E	2 x RCI-2.0FSR	7.04	3.56	A++	10.00	4.64	4.38	A++	8.70
		2 x RPI-2.0FSRE	5.75	3.24	A+	10.00	3.91	3.71	A	8.70
	RAS-5HVNP2E	-	7.80	3.26	-	12.50	4.68	4.13	-	11.93
	RAS-6HVNP2E	-	7.01	2.85	-	14.00	4.71	4.40	-	14.20

3.3.3 UTOPIA Prime three phase series

System combination			Cooling				Heating			
Refrigerant	Outdoor unit	Indoor unit	SEER	EER	Energy Class	P Design (35°C)	SCOP	COP	Energy Class	P Design (-10°C)
			-	-	-	kW				-
R32	RAS-4HRC2E	RCI-4.0FSR	6.62	3.90	A++	10.00	4.36	4.23	A+	8.70
		RPIH-4.0FSRE	6.84	3.73	A++	10.00	4.38	3.73	A+	8.70
		RPI-4.0FSRE	6.17	3.62	A++	10.00	4.04	3.63	A+	8.70
		RPC-4.0FSR	5.70	3.47	A+	10.00	4.12	3.47	A+	8.70
		RPK-4.0FSR(H)M	6.18	2.42	A++	10.00	3.80	2.82	A	7.40
	RAS-5HRC2E	RCI-5.0FSR	6.37	3.52	A++	11.90	4.25	3.98	A+	11.93
		RPI(H)-5.0FSRE	6.79	3.37	A++	11.90	4.36	3.52	A+	11.93
		RPI-5.0FSRE	5.89	3.26	A+	11.90	4.03	3.42	A+	11.93
		RPC-5.0FSR	5.89	3.06	A+	11.90	4.09	3.21	A+	11.93
	RAS-6HRC2E	2 x RCI-3.0FSR	7.25	3.24	-	14.00	4.73	4.40	-	14.20
2 x RPI-3.0FSRE		7.20	3.09	-	14.00	4.73	4.40	-	14.20	
R410A	RAS-4HNC2E	RCI-4.0FSR	6.42	3.50	A++	10.00	4.40	4.30	A+	8.70
		RPIH-4.0FSRE	6.60	3.33	A++	10.00	4.43	3.79	A+	8.70
		RPI-4.0FSRE	5.96	3.24	A+	10.00	4.09	3.71	A+	8.70
		RPC-4.0FSR	5.51	3.10	A	10.00	4.17	3.53	A+	8.70
		RPK-4.0FSR(H)M	5.92	2.16	A+	10.00	3.83	2.87	A	7.40
	RAS-5HNC2E	RCI-5.0FSR	6.13	3.15	A++	11.90	4.23	3.98	A+	11.93
		RPI(H)-5.0FSRE	6.52	3.01	A++	11.90	4.34	3.52	A+	11.93
		RPI-5.0FSRE	5.68	2.92	A+	11.90	3.93	3.42	A	11.93
		RPC-5.0FSR	5.67	2.74	A+	11.90	4.09	3.21	A+	11.93
	RAS-6HNC2E	2 x RCI-3.0FSR	6.92	2.85	-	14.00	4.71	4.40	-	14.20
2 x RPI-3.0FSRE		6.90	2.81	-	14.00	4.70	4.40	-	14.20	

3.3.4 UTOPIA IVX Prime three phase series

System combination			Cooling				Heating			
Refrigerant	Outdoor unit	Indoor unit	SEER	EER	Energy Class	P Design (35°C)	SCOP	COP	Energy Class	P Design (-10°C)
			-	-	-	kW				-
R32	RAS-4HRP2E	2 x RCI-2.0FSR	6.96	3.98	A++	10.00	4.60	4.31	A++	8.70
		2 x RPI-2.0FSRE	5.71	3.55	A+	10.00	3.91	3.71	A	8.70
	RAS-5HRP2E	-	8.20	3.66	-	12.50	4.75	4.13	-	11.93
	RAS-6HRP2E	-	7.25	3.24	-	14.00	4.73	4.40	-	14.20
R410A	RAS-4HNP2E	2 x RCI-2.0FSR	6.72	3.56	A++	10.00	4.64	4.38	A++	8.70
		2 x RPI-2.0FSRE	5.54	3.24	A	10.00	3.91	3.71	A	8.70
	RAS-5HNP2E	-	7.67	3.26	-	12.50	4.68	4.13	-	11.93
	RAS-6HNP2E	-	6.92	2.85	-	14.00	4.71	4.40	-	14.20

3.4 Component data

◆ RAS-(3-6)H(V)(R/N)C2(E)

MODEL		RAS-3HVRC2	RAS-4H(V)(R/N)C2E	RAS-5H(V)(R/N)C2E	RAS-6H(V)(R/N)C2E
Heat exchanger	Type	Multi-pass cross-finned tube			
	Pipe material	Copper			
	Outer diameter	mm	7	7	
	Rows	2			
	Number of tubes in the heat exchanger		44	108	
	Fin material	Aluminium			
	Fin pitch		1.45	1.4	
	Maximum operating pressure	MPa	4.15		
	Total front area	m ²	0.47	1.11	
	Number of heat exchanger per unit	1			
Fan	Fan type	Direct drive propeller fan			
	Fans per unit	1			
	Outer diameter	mm	449	544	
	Revolutions	rpm	970	822	
	Nominal air flow	m ³ /min	45	80	
Motor	Shell	Drip-proof type enclosure			
	Starting	Direct current control			
	Power	W	50	200	
	Quantity		1	1	
	Insulation class	E			
Compressor	Model	GTD163UKQA8LTH	GTH356SDPC9FQ		
	Oil type	ACS68R	ACS68R		
	Quantity	0.75	1.65		

◆ RAS-(4-6)H(V)(R/N)P2E

MODEL		RAS-4H(V)(R/N)P2E	RAS-5H(V)(R/N)P2E	RAS-6H(V)(R/N)P2E
Heat exchanger	Type	Multi-pass cross-finned tube		
	Pipe material	Copper		
	Outer diameter	mm	7	
	Rows	2		
	Number of tubes in the heat exchanger	108		
	Fin material	Aluminium		
	Fin pitch	1.4		
	Maximum operating pressure	MPa	4.15	
	Total front area	m ²	1.11	
	Number of heat exchanger per unit	1		
Fan	Fan type	Direct drive propeller fan		
	Fans per unit	1		
	Outer diameter	mm	544	
	Revolutions	rpm	822	
	Nominal air flow	m ³ /min	80	
Motor	Shell	Drip-proof type enclosure		
	Starting	Direct current control		
	Power	W	200	
	Quantity	1		
	Insulation class	E		
Compressor	Model	GTH356SDPC9FQ		
	Oil type	ACS68R		
	Quantity	1.65		

3.5 Electrical data

Keywords:

- U: Power supply.
- PH: Phase.
- f: Frequency.
- STC: Starting current: Less than maximum current.
- IPT: Total input power.
- RNC: Running current.
- MC: Maximum current.
- CB: Circuit breaker
- ELB: Earth leakage breaker (N° of poles/A/mA)

CAUTION

- *Ensure specifically that there is an Earth Leakage Breaker (ELB) installed for the units (outdoor and indoor unit).*
- *If the installation is already equipped with an Earth Leakage Breaker (ELB), ensure that its rated current is large enough to hold the current of the units (outdoor and indoor unit).*

NOTE

- *Electric fuses can be used instead of magnetic Circuit Breakers (CB). In that case, select fuses with similar rated values as the CB.*
- *The Earth Leakage Breaker (ELB) mentioned on this Technical Catalogue is also commonly known as Residual Current Device (RCD) or Residual Current Circuit Breaker (RCCB).*
- *The Circuit Breakers (CB) are also known as Thermal-Magnetic Circuit Breakers or just Magnetic Circuit Breakers (MCB).*

3.5.1 UTOPIA series

Outdoor unit	Main unit power			Applicable voltage		Unit data						CB (A)	ELB (N°. of poles/A/ mA)	
	U (V)	PH	f (Hz)	U max (V)	U min (V)	STC (A)	Cooling		Heating		MC (A)			Max. IPT (kW)
							RNC (A)	IPT (kW)	RNC (A)	IPT (kW)				
RAS-3HVRC2	230	1	50	253	207	-	7.6	1.67	8.1	1.79	15.8	3.5	20	2/40/30
RAS-4HVRC2E							12.4	2.56	12.8	2.65	22.5	4.6	25	
RAS-5HVRC2E							16.3	3.38	17.0	3.52	22.5	4.6	25	
RAS-6HVRC2E							21.1	4.38	17.6	3.64	22.5	4.6	25	
RAS-4HVNC2E							13.8	2.86	12.6	2.60	22.5	4.6	25	
RAS-5HVNC2E							18.3	3.78	17.0	3.52	22.5	4.6	25	
RAS-6HVNC2E							23.7	4.91	17.6	3.64	22.5	4.6	25	
RAS-4HVRP2E							12.1	2.51	12.6	2.60	22.5	4.6	25	
RAS-5HVRP2E							16.5	3.42	16.4	3.39	22.5	4.6	25	
RAS-6HVRP2E							21.1	4.38	17.6	3.64	22.5	4.6	25	
RAS-4HVNP2E							13.6	2.81	12.4	2.56	22.5	4.6	25	
RAS-5HVNP2E							18.5	3.83	16.4	3.39	22.5	4.6	25	
RAS-6HVNP2E							23.7	4.91	17.6	3.64	22.5	4.6	25	
RAS-4HNC2E	400	3	50	440	360	-	4.9	2.86	4.4	2.60	15	6.7	20	4/40/30
RAS-5HNC2E							6.4	3.78	6.0	3.52	15	6.7	20	
RAS-6HNC2E							8.3	4.91	6.2	3.64	15	6.7	20	
RAS-4HRC2E							4.4	2.56	4.5	2.65	15	6.7	20	
RAS-5HRC2E							5.7	3.38	6.0	3.52	15	6.7	20	
RAS-6HRC2E							7.4	4.38	6.2	3.64	15	6.7	20	
RAS-4HRP2E							4.3	2.51	4.4	2.60	15	6.7	20	
RAS-5HRP2E							5.8	3.42	5.8	3.39	15	6.7	20	
RAS-6HRP2E							7.4	4.38	6.2	3.64	15	6.7	20	
RAS-4HNP2E							4.8	2.81	4.3	2.56	15	6.7	20	
RAS-5HNP2E							6.5	3.83	5.8	3.39	15	6.7	20	
RAS-6HNP2E							8.3	4.91	6.2	3.64	15	6.7	20	

 **NOTE**

Specifications in these tables are subject to change without notice in order that Hitachi may bring the latest innovations to their customers.

4 . Capacities and selection data

Index

4.1	Combinability range.....	48
4.1.1	Connected number of indoor units	48
4.1.2	Connected capacity ratio.....	49
4.2	System selection procedure	50
4.2.1	Selection procedure (step 1)	50
4.2.2	Selection procedure (step 2)	52
4.3	Maximum cooling capacity	53
4.4	Maximum heating capacity.....	55
4.5	Correction indoor fan speed factor	57
4.5.1	Cooling	57
4.5.2	Heating	57
4.6	Piping length correction factor (f_{LC} , f_{LH}).....	57
4.7	Defrost Operation correction factor (f_D).....	59
4.8	Correction ratio due to humidity (CR).....	59
4.9	Correction factor according to altitude (f_{AL}).....	59

4.1 Combinability range

4.1.1 Connected number of indoor units

Range of operation capacity control from 90 to 100% for 1 or 2 indoor units (RAS-3HVRC2) and 90 up to 115% for 1 to 4 indoor units (RAS-(4-6)H(V)(R/N)(C/P)2E).

Outdoor unit	Minimum combination capacity (HP)	Maximum combination capacity (HP)	Maximum Combination quantity	Minimum indoor unit capacity (HP)
RAS-3HVRC2	2.7	3	2	0.8
RAS-4H(V)R(C/P)2E	3.6	4.6	4	0.8
RAS-5H(V)R(C/P)2E	4.5	5.75	4	0.8
RAS-6H(V)R(C/P)2E	5.4	6.9	4	0.8
RAS-4H(V)N(C/P)2E	3.6	4.6	4	0.8
RAS-5H(V)N(C/P)2E	4.5	5.75	4	0.8
RAS-6H(V)N(C/P)2E	5.4	6.9	4	0.8



NOTE

- In case of installation in cold territories (where Outdoor Temperature may fall below -5°C) or in places where Heating load is large, install a number of units with a connected capacity ratio under 100%.
- Please check the piping chapter for other restrictions and limitations to adequate the combinability and the number of indoor units installed.
- See "9. Piping work and refrigerant charge" for detailed information and additional remarks about combinability.

4.1.2 Connected capacity ratio

	❄️☀️			
	Outdoor unit model			
	3 HP	4 HP	5 HP	6 HP
Maximum number of connected indoor units	2	4		
Connected capacity ratio of indoor unit % (number of connected Indoor Units)	90-100% (1 or 2 units)	90-115% (1 to 4 units)		
Minimum capacity of indoor units (HP)	0.8			

NOTE

Where the parameters of installation are close to their limit values (long indoor-to-indoor pipe distances, high outdoor-to-indoor height difference, long pipes in general, etc) it is recommended to follow Table 1 (see remarks) for best comfort.

◆ Remarks

1 Table 1

Indoor unit with the highest capacity (HP)	0.8	1.0	1.3	1.5	1.8	2.0	2.3	2.5	3.0	4.0	5.0	6.0
Indoor unit with the lowest capacity (HP)	0.8		1.0		1.3		1.5		1.8		2.0	

2 In systems where all the units belong to the 4-Way RCI-FSR model, the maximum allowed capacity ratio of connected indoor units is 100%, and the maximum number of connectable indoor units are:

OU model	3 HP	4 HP	5 HP	6 HP
Maximum number of IU	1	2		

- 3 When installing RPF(I)-2.0FSN2E or RPF(I)-2.5FSN2E, single combination with UTOPIA Prime / UTOPIA IVX Prime and UTOPIA IVX Standard / UTOPIA IVX Premium series is not allowed.
- 4 In case of installation in cold territories (where outdoor temperature may fall below -5°C) or in places where heating load is large, install a number of units with a connected capacity ratio under 100%.
- 5 Please check the piping chapter for other restrictions and limitations to adequate the combinability and the number of indoor units installed.

4.2 System selection procedure

This combinability allows the outdoor unit to be smaller capacity when compared with other air conditioning systems, in case of the total combination horsepower, but considering that maximum load demands can not be simultaneous.

A: morning peak heat load in the eastern area. (example: 3 HP)

B: evening peak heat load in the western area. (example: 3.5 HP)

C: maximum simultaneous load for the entire building.

D: eastern area load.

E: total load.

F: western area load.

G: load.

H: time.

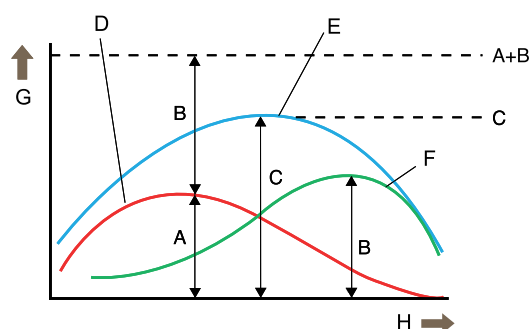

The diagram shows a typical building with a morning peak heat load on the east zone equivalent to a 3 HP unit. In the afternoon a peak occurs on the west zone equivalent to a 3.5 HP unit.

Therefore, a conventional system would require total installed plant of $A+B : 3 \text{ HP} + 3.5 \text{ HP} = 6.5 \text{ HP}$ (next capacity available is 8 HP). The maximum simultaneous load on the whole building occurs at noon and is equivalent to a 6 HP capacity (as example). A RAS-6H(V)(R/N)(C/P)2E unit can be selected, and this capacity can be directed either to the east or west zone as dictated by the systems controls. Then the UTOPIA series 6 HP outdoor unit can be selected, against the 8 HP required in a typical system (25% reduction).

The following figure shows the capacity curve depending on the combined indoor units.

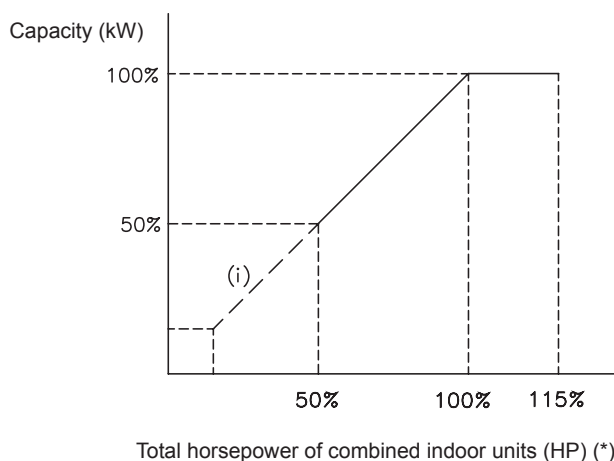

i NOTE

- (*) This range can be different depending the outdoor and indoor unit model.
- (i) Capacity when some indoor units are off

4.2.1 Selection procedure (step 1)

Considering the layout of the building, the possible position of the indoor units and the air flow distribution, select the unit features that provide the greatest efficiency and comfort. Decide a position for the outdoor unit that facilitates service and maintenance tasks.

- 1 **Determine the total load required for each room.**
- 2 **Select, per each room, the appropriate Indoor Unit according to the required load and the installation characteristics.**

In some, situations, it should be useful to adjust the capacity of the indoor units in order to adapt the unit to the actual installation requirements. This function is performed by dip switch setting and it's possible in some HP indoor unit models.

In case of an installation with ducts (outdoor unit with RPI indoor unit) the fan performance for duct calculations should be considered. The RPI units are designed with different static pressure ranges in order to fulfil all installation necessities.

3 Pre-select the outdoor units that covers the installation's cooling load requirements

If the required loads will not be simultaneous (for example: the maximum required loads of room 1 (east zone) occurs at the morning and the maximum required loads of room 2 (west zone) occurs at the afternoon.), select the outdoor unit that cover the maximum simultaneous load on the installation and check that the total combination horsepower must not be higher than the limits, using the following:

$$\text{Total combination horsepower} = (\text{Total indoor unit horsepower} / \text{Outdoor unit horsepower}) \times 100$$

4 Calculation of f_{LC} (Cooling piping length correction factor)

The length of the refrigerant piping used and the height difference between the outdoor unit and the indoor units directly affect the performance of the unit. This concept is quantified in the piping length correction factor.

To determine this value it is necessary refer to the piping length correction factor tables that are based on the equivalent piping length in meter and height between outdoor and indoor units. For the equivalent one-way piping length between indoor unit and outdoor unit (m) consider the following:

One 90° elbow is 0.5 m.

One 180° bend is 1.5 m.

One Multi-kit is 0.5 m.

5 Calculation of f_{AL} (Correction factor according to altitude)

The capacity is affected by the altitude of the installation location. When the altitude is above sea level, capacity must be corrected with the altitude correction factor according to the "Correction factor due to altitude" table.

6 Cooling capacity correction (Q_c) due to the piping length and altitude factor

The actual cooling capacity of the pre-selected unit must be calculated applying the necessary correction factors:

$$Q_c = Q_{MC} \times f_{LC} \times f_{AL}$$

Q_c : Actual cooling capacity of the outdoor unit (kW).

Q_{MC} : Maximum cooling capacity of the outdoor unit (kW).

f_{LC} : Cooling piping length correction factor.

f_{AL} : Corrections factor according to altitude.

7 Cooling capacity correction of the outdoor unit (Q_{AC}) depending of the humidity of the indoor unit

The correction ratio due to humidity is the coefficient that corrects the sensible heat capacity of a unit according to the relative humidity of the air entering the indoor unit. The greater the relative humidity the lower will be the sensible heat capacity and vice versa.

The following formula is used to apply an adjustment to the cooling capacity showed in the tables due to the difference between the real indoor air inlet dry bulb temperature vs the one used for calculate the nominal cooling capacity data.

$$Q_{AC} = Q_c + (CR \times (DB_R - DB))$$

Q_{AC} : Actual cooling capacity of the outdoor unit (kW) (at given real % humidity)

Q_c : Corrected cooling capacity of the outdoor unit by piping length (kW) (at given 50 % humidity)

CR : Correction ratio due to humidity.

DB_R : Real Dry Bulb evaporator temperature (°C).

DB : Dry Bulb evaporator temperature (°C) for each wet bulb temperature from the tables (HR = 50 %).

8 Actual indoor units capacity

Once it is known the actual outdoor units cooling capacity, it must be calculated the actual cooling capacity of each indoor unit, according to the following formula:

$$Q_{CI} = Q_{AC} \times (Q_{NCI} / Q_{NCC})$$

Q_{CI} : Actual cooling capacity of the indoor unit (kW).

Q_{AC} : Actual cooling capacity of the outdoor unit (kW).

Q_{NCI} : Nominal cooling capacity of the indoor unit (kW).

Q_{NCC} : Nominal cooling capacity of the combination (kW).

9 Sensible heat capacity (SHC)

Once the calculation of the indoor units cooling capacity has been completed, the sensible heat capacity can be calculated using the following formula:

$$SHC = Q_{ci} \times SHF$$

SHC: Sensible heat capacity (kW).

Q_{ci} : Actual cooling capacity of the indoor unit (kW).

SHF: Sensible heat factor.

10 Checks

Check that the total capacity and sensible heat capacity (SHC) are greater than the estimated cooling load by the different rooms to be conditioned. Therefore, it can be said that the selected outdoor unit meets the minimum cooling requirements set for the system.

Corrected total cooling capacity (kW) _{TOTAL}	≥	Estimated total cooling load (kW) _{TOTAL}
Corrected sensible heat capacity (kW) _{TOTAL}	≥	Estimated sensible heat capacity (kW) _{TOTAL}
Corrected total cooling capacity (kW) _{ROOMn}	≥	Estimated total cooling load (kW) _{ROOMn}
Corrected sensible heat capacity (kW) _{ROOMn}	≥	Estimated sensible heat capacity (kW) _{ROOMn}

4.2.2 Selection procedure (step 2)

1 Calculate the heating requirements for each room

See if the pre-selected indoor units and outdoor units have the necessary nominal heating capacity for each room.

2 Heating capacity correction (Q_H)

The actual heating capacity of the pre-selected outdoor unit (in cooling mode (step 1)) must be calculated applying the necessary correction factors:

$$Q_H = Q_{MH} \times f_{LH} \times f_D \times f_{AL}$$

Q_H : Actual heating capacity of the outdoor unit (kW)

Q_{MH} : Maximum heating capacity of the outdoor unit (kW)

f_{LH} : Heating piping length correction factor

f_D : Defrost correction factor

f_{AL} : Corrections factor according to altitude.

Calculation of f_{LH}

Referring to the diagrams for "[4.6 Piping length correction factor \(fLC, fLH\)](#)".

Calculation of f_D

In situations where the ambient temperature is lower than 7 °C DB, frost may build up on the heat exchanger. In this case, the heating capacity for the unit may be reduced because of the time spent by the unit in removing the frost up.

The defrost correction factor takes this time into account to apply the heating capacity correction.

3 Heating capacity of each indoor unit (Q_{HI})

Once the real heating capacity of the outdoor unit has been determined, its heating capacity in combination with the indoor units, can be calculated.

$$Q_{HI} = Q_H \times (Q_{NHI} / Q_{NHC})$$

Q_{HI} : Actual heating capacity of the indoor unit (kW).

Q_H : Actual heating capacity of the outdoor unit (kW)

Q_{NHI} : Nominal heating capacity of the indoor unit (kW)

Q_{NHC} : Nominal heating capacity of the combination (kW)

If the corrected heating capacity is greater than the estimated heating load by the different rooms to be conditioned, it can be said that the selection is valid for both cooling and heating.

Actual heating capacity (kW) _{TOTAL}	≥	Estimated heating capacity (kW) _{TOTAL}
Actual heating capacity (kW) _{ROOMn}	≥	Estimated heating capacity (kW) _{ROOMn}

4.3 Maximum cooling capacity

Tables are based on the following conditions:

The tables are based on High speed of indoor fan. To calculate the cooling capacity of medium or low speed of indoor fan, multiply cooling capacity of high speed by Correction Curve Factor (Chapter "4.5 Correction indoor fan speed factor").

◆ R32 single phase

All temperatures in °C.

Outdoor unit	Outdoor air inlet temperature (DB)	Indoor air inlet temperature WB (°C) / (DB (°C))								
		15/(21)			19/(27)			23/(32)		
		CAP max	IPT	EER	CAP max	IPT	EER	CAP max	IPT	EER
RAS-3HVRC2	25	7.70	2.48	3.11	8.50	2.50	3.40	9.10	2.46	3.69
	30	7.41	2.14	3.47	8.22	2.17	3.78	8.80	2.15	4.10
	35	7.26	2.15	3.38	8.00	2.17	3.69	8.60	2.15	4.01
	40	6.69	2.03	3.29	7.30	2.03	3.60	7.93	2.03	3.90
RAS-4HVR(C/P)2E	25	10.6	3.10	3.42	11.8	3.17	3.73	13.1	3.24	4.04
	30	10.3	3.18	3.24	11.5	3.26	3.53	12.8	3.34	3.83
	35	10.0	3.35	2.99	11.2	3.44	3.26	12.4	3.51	3.53
	40	9.7	3.56	2.72	10.9	3.67	2.97	11.9	3.69	3.22
RAS-5HVR(C/P)2E	25	13.2	3.90	3.39	14.7	3.98	3.70	15.8	3.94	4.01
	30	12.7	3.95	3.21	14.3	4.08	3.51	15.4	4.05	3.81
	35	12.1	4.08	2.97	14.0	4.33	3.24	14.8	4.21	3.51
	40	11.5	4.25	2.71	13.0	4.40	2.96	14.0	4.36	3.21
RAS-6HVR(C/P)2E	25	14.0	4.02	3.47	15.3	4.04	3.78	18.1	4.41	4.11
	30	13.6	4.13	3.29	14.9	4.17	3.59	15.9	4.09	3.89
	35	12.5	4.13	3.04	14.0	4.38	3.20	15.2	4.23	3.60
	40	11.9	4.29	2.77	13.3	4.39	3.02	14.6	4.44	3.28

NOTE

IPT data considering Outdoor Unit only.

◆ R32 three phase

All temperatures in °C.

Outdoor unit	Outdoor air inlet temperature (DB)	Indoor air inlet temperature WB (°C) / (DB (°C))								
		15/(21)			19/(27)			23/(32)		
		CAP max	IPT	EER	CAP max	IPT	EER	CAP max	IPT	EER
RAS-4HR(C/P)2E	25	10.6	3.10	3.42	11.8	3.17	3.73	13.1	3.24	4.04
	30	10.3	3.18	3.24	11.5	3.26	3.53	12.8	3.34	3.83
	35	10.0	3.35	2.99	11.2	3.44	3.26	12.4	3.51	3.53
	40	9.7	3.56	2.72	10.9	3.67	2.97	11.9	3.69	3.22
RAS-5HR(C/P)2E	25	13.2	3.90	3.39	14.7	3.98	3.70	15.8	3.94	4.01
	30	12.7	3.95	3.21	14.3	4.08	3.51	15.4	4.05	3.81
	35	12.1	4.08	2.97	14.0	4.33	3.24	14.8	4.21	3.51
	40	11.5	4.25	2.71	13.0	4.40	2.96	14.0	4.36	3.21
RAS-6HR(C/P)2E	25	15.5	5.43	2.86	17.0	5.46	3.12	18.1	5.35	3.38
	30	15.1	5.58	2.71	16.6	5.62	2.95	17.7	5.52	3.21
	35	14.3	5.70	2.50	16.0	5.87	2.73	16.9	5.71	2.96
	40	13.5	5.91	2.28	15.1	6.06	2.49	16.2	5.99	2.70

NOTE

IPT data considering Outdoor Unit only.

Maximum cooling capacity

◆ R410A single phase

All temperatures in °C.

Outdoor unit	Outdoor air inlet temperature (DB)	Indoor air inlet temperature WB (°C) / (DB (°C))								
		15/(21)			19/(27)			23/(32)		
		CAP max	IPT	EER	CAP max	IPT	EER	CAP max	IPT	EER
RAS-4HVN(C/P)2E	25	10.6	3.42	3.10	11.8	3.49	3.38	13.1	3.57	3.38
	30	10.3	3.51	2.94	11.5	3.59	3.20	12.8	3.68	3.20
	35	10.0	3.69	2.71	11.2	3.79	2.95	12.4	3.87	3.02
	40	9.7	3.93	2.47	10.9	4.05	2.69	11.9	4.07	2.69
RAS-5HVN(C/P)2E	25	13.2	4.39	3.01	14.7	4.48	3.28	15.8	4.44	3.56
	30	12.7	4.46	2.85	14.3	4.60	3.11	15.4	4.56	3.37
	35	12.1	4.60	2.63	14.0	4.88	2.87	14.8	4.75	3.12
	40	11.5	4.79	2.40	13.0	4.96	2.62	14.0	4.92	2.85
RAS-6HVN(C/P)2E	25	14.0	4.53	3.08	15.3	4.56	3.36	18.1	4.96	3.65
	30	13.6	4.66	2.92	14.9	4.69	3.18	15.9	4.61	3.46
	35	12.5	4.65	2.69	14.0	4.91	2.85	15.2	4.77	3.19
	40	11.9	4.83	2.46	13.3	4.95	2.68	14.6	5.00	2.91

 **NOTE**

IPT data considering Outdoor Unit only.

◆ R410A three phase

All temperatures in °C.

Outdoor unit	Outdoor air inlet temperature (DB)	Indoor air inlet temperature WB (°C) / (DB (°C))								
		15/(21)			19/(27)			23/(32)		
		CAP max	IPT	EER	CAP max	IPT	EER	CAP max	IPT	EER
RAS-4HN(C/P)2E	25	10.6	3.42	3.10	11.8	3.49	3.38	13.1	3.57	3.38
	30	10.3	3.51	2.94	11.5	3.59	3.20	12.8	3.68	3.20
	35	10.0	3.69	2.71	11.2	3.79	2.95	12.4	3.87	3.02
	40	9.7	3.93	2.47	10.9	4.05	2.69	11.9	4.07	2.69
RAS-5HN(C/P)2E	25	13.2	4.39	3.01	14.7	4.48	3.28	15.8	4.44	3.56
	30	12.7	4.46	2.85	14.3	4.60	3.11	15.4	4.56	3.37
	35	12.1	4.60	2.63	14.0	4.88	2.87	14.8	4.75	3.12
	40	11.5	4.79	2.40	13.0	4.96	2.62	14.0	4.92	2.85
RAS-6HN(C/P)2E	25	15.5	6.11	2.54	17.0	6.15	2.77	18.1	6.03	3.00
	30	15.1	6.28	2.40	16.6	6.33	2.62	17.7	6.22	2.85
	35	14.3	6.42	2.22	16.0	6.61	2.42	16.9	6.43	2.63
	40	13.5	6.66	2.03	15.1	6.83	2.21	16.2	6.75	2.40

 **NOTE**

IPT data considering Outdoor Unit only.

4.4 Maximum heating capacity

Tables are based on the following conditions:

The tables are based on High speed of indoor fan. To calculate the cooling capacity of medium or low speed of indoor fan, multiply cooling capacity of high speed by Correction Curve Factor (Chapter "4.5 Correction indoor fan speed factor").

The Tables does not include decreasing capacity by defrosting operation.

◆ R32 refrigerant single and three phase

All temperatures in °C.

Outdoor unit	Outdoor air inlet temperature (DB)	Indoor air inlet temperature WB (°C) / (DB (°C))															
		15		16		18		20		22		24		26		28	
		CAP max	IPT	CAP max	IPT	CAP max	IPT	CAP max	IPT	CAP max	IPT	CAP max	IPT	CAP max	IPT	CAP max	IPT
RAS-3HVR2	-20	4.00	1.97	3.97	1.99	3.91	2.04	3.85	2.08	3.80	2.14	3.74	2.19	3.68	2.24	3.62	2.30
	-15	4.78	2.12	4.75	2.15	4.69	2.20	4.63	2.26	4.58	2.33	4.52	2.39	4.46	2.45	4.40	2.53
	-10	5.60	2.33	5.57	2.36	5.51	2.42	5.45	2.49	5.40	2.57	5.34	2.64	5.28	2.72	5.22	2.81
	-5	6.60	2.48	6.57	2.51	6.50	2.58	6.44	2.66	6.37	2.73	6.31	2.82	6.24	2.90	6.18	3.00
	0	7.92	2.40	7.89	2.43	7.82	2.50	7.75	2.58	7.69	2.66	7.62	2.74	7.56	2.83	7.49	2.93
	5	10.00	2.44	9.96	2.48	9.88	2.55	9.81	2.63	9.73	2.71	9.65	2.80	9.58	2.89	9.50	2.99
	10	11.09	2.41	11.05	2.44	10.96	2.51	10.87	2.59	10.78	2.67	10.70	2.75	10.61	2.84	10.52	2.94
	15	11.60	2.37	11.60	2.42	11.60	2.51	11.60	2.61	11.60	2.71	11.60	2.82	11.60	2.94	11.60	3.06
RAS-4H(V)(C/P)2E	-20	8.20	3.61	8.09	3.63	7.88	3.67	7.66	3.71	7.42	3.74	7.19	3.77	6.96	3.80	6.73	3.83
	-15	9.39	3.74	9.29	3.77	9.09	3.83	8.89	3.89	8.68	3.95	8.46	4.01	8.24	4.06	8.02	4.12
	-10	10.55	3.90	10.47	3.94	10.31	4.03	10.14	4.12	9.94	4.19	9.73	4.27	9.52	4.35	9.31	4.43
	-5	11.74	3.92	11.67	3.97	11.53	4.07	11.38	4.17	11.19	4.26	11.00	4.36	10.81	4.46	10.62	4.57
	0	12.92	3.70	12.86	3.75	12.74	3.86	12.62	3.97	12.45	4.08	12.26	4.18	12.07	4.29	11.88	4.40
	5	14.01	3.58	13.97	3.64	13.89	3.76	13.77	3.87	13.62	3.98	13.45	4.09	13.28	4.21	13.11	4.33
	10	15.48	4.05	15.47	4.12	15.45	4.27	15.35	4.41	15.23	4.55	15.07	4.68	14.91	4.82	14.75	4.97
	15	17.12	4.84	17.10	4.92	17.07	5.10	17.05	5.29	16.94	5.46	16.78	5.62	16.62	5.80	16.46	5.98
RAS-5H(V)(C/P)2E	-20	8.62	4.01	8.58	4.07	8.51	4.19	8.44	4.31	8.40	4.46	8.37	4.62	8.34	4.79	8.31	4.97
	-15	10.26	4.32	10.22	4.38	10.15	4.52	10.12	4.67	10.03	4.81	10.00	4.99	9.97	5.18	9.94	5.38
	-10	11.95	4.66	11.92	4.74	11.87	4.90	11.79	5.05	11.74	5.22	11.72	5.42	11.70	5.63	11.68	5.86
	-5	13.65	4.81	13.61	4.89	13.53	5.04	13.46	5.21	13.37	5.37	13.31	5.56	13.25	5.76	13.19	5.98
	0	15.84	4.79	15.79	4.87	15.69	5.02	15.60	5.18	15.49	5.34	15.40	5.52	15.31	5.71	15.22	5.91
	5	18.04	4.89	18.00	4.97	17.92	5.13	17.81	5.30	17.67	5.46	17.54	5.64	17.41	5.83	17.28	6.03
	10	19.04	5.26	19.00	5.35	18.92	5.52	18.79	5.69	18.65	5.87	18.47	6.04	18.29	6.22	18.11	6.42
	15	19.74	5.88	19.69	5.98	19.60	6.17	19.49	6.37	19.35	6.57	19.13	6.75	18.91	6.95	18.69	7.16
RAS-6H(V)(C/P)2E	-20	9.30	4.03	9.25	4.09	9.15	4.20	9.10	4.33	9.03	4.47	9.00	4.63	8.97	4.81	8.94	5.00
	-15	11.04	4.33	11.01	4.40	10.96	4.54	10.89	4.68	10.85	4.85	10.82	5.02	10.79	5.22	10.76	5.42
	-10	12.80	4.65	12.76	4.72	12.96	4.97	12.64	5.03	12.59	5.21	12.55	5.39	12.51	5.59	12.47	5.81
	-5	14.87	4.88	14.82	4.96	14.73	5.11	14.64	5.28	14.55	5.45	14.48	5.64	14.41	5.85	14.34	6.07
	0	17.46	4.91	17.41	4.99	17.31	5.15	17.20	5.31	17.08	5.48	16.97	5.66	16.86	5.85	16.75	6.06
	5	20.11	5.07	20.04	5.14	19.90	5.30	19.75	5.46	19.61	5.63	19.45	5.81	19.29	6.00	19.13	6.20
	10	21.15	5.44	21.10	5.53	21.00	5.71	20.89	5.90	20.80	6.10	20.66	6.30	20.52	6.52	20.38	6.75
	15	22.31	6.18	22.22	6.27	22.04	6.45	21.90	6.65	21.76	6.87	21.64	7.10	21.52	7.35	21.40	7.61

NOTE

IPT data considering Outdoor Unit only.

Maximum heating capacity

◆ R410A refrigerant single and three phase

All temperatures in °C.

Outdoor unit	Outdoor air inlet temperature (DB)	Indoor air inlet temperature WB (°C) / (DB (°C))															
		15		16		18		20		22		24		26		28	
		CAP max	IPT	CAP max	IPT	CAP max	IPT	CAP max	IPT	CAP max	IPT	CAP max	IPT	CAP max	IPT	CAP max	IPT
RAS-4H(V)(C/P)2E	-20	8.20	3.56	8.09	3.57	7.88	3.62	7.66	3.65	7.42	3.68	7.19	3.71	6.96	3.74	6.73	3.78
	-15	9.39	3.68	9.29	3.71	9.09	3.77	8.89	3.83	8.68	3.88	8.46	3.94	8.24	4.00	8.02	4.06
	-10	10.55	3.83	10.47	3.87	10.31	3.96	10.14	4.04	9.94	4.12	9.73	4.19	9.52	4.27	9.31	4.35
	-5	11.74	3.85	11.67	3.90	11.53	4.00	11.38	4.10	11.19	4.19	11.00	4.28	10.81	4.38	10.62	4.49
	0	12.92	3.63	12.86	3.69	12.74	3.79	12.62	3.90	12.45	4.00	12.26	4.10	12.07	4.21	11.88	4.32
	5	14.01	3.52	13.97	3.58	13.89	3.69	13.77	3.80	13.62	3.91	13.45	4.02	13.28	4.13	13.11	4.26
	10	15.48	3.98	15.47	4.05	15.45	4.20	15.35	4.33	15.23	4.47	15.07	4.59	14.91	4.73	14.75	4.88
	15	17.12	4.76	17.10	4.84	17.07	5.01	17.05	5.20	16.94	5.36	16.78	5.52	16.62	5.69	16.46	5.88
RAS-5H(V)(C/P)2E	-20	8.62	4.01	8.58	4.07	8.51	4.19	8.44	4.31	8.40	4.46	8.37	4.62	8.34	4.79	8.31	4.97
	-15	10.26	4.32	10.22	4.38	10.15	4.52	10.12	4.67	10.03	4.81	10.00	4.99	9.97	5.18	9.94	5.38
	-10	11.95	4.66	11.92	4.74	11.87	4.90	11.79	5.05	11.74	5.22	11.72	5.42	11.70	5.63	11.68	5.86
	-5	13.65	4.81	13.61	4.89	13.53	5.04	13.46	5.21	13.37	5.37	13.31	5.56	13.25	5.76	13.19	5.98
	0	15.84	4.79	15.79	4.87	15.69	5.02	15.60	5.18	15.49	5.34	15.40	5.52	15.31	5.71	15.22	5.91
	5	18.04	4.89	18.00	4.97	17.92	5.13	17.81	5.30	17.67	5.46	17.54	5.64	17.41	5.83	17.28	6.03
	10	19.04	5.26	19.00	5.35	18.92	5.52	18.79	5.69	18.65	5.87	18.47	6.04	18.29	6.22	18.11	6.42
	15	19.74	5.88	19.69	5.98	19.60	6.17	19.49	6.37	19.35	6.57	19.13	6.75	18.91	6.95	18.69	7.16
RAS-6H(V)(C/P)2E	-20	9.30	4.03	9.25	4.09	9.15	4.20	9.10	4.33	9.03	4.47	9.00	4.63	8.97	4.81	8.94	5.00
	-15	11.04	4.33	11.01	4.40	10.96	4.54	10.89	4.68	10.85	4.85	10.82	5.02	10.79	5.22	10.76	5.42
	-10	12.80	4.65	12.76	4.72	12.96	4.97	12.64	5.03	12.59	5.21	12.55	5.39	12.51	5.59	12.47	5.81
	-5	14.87	4.88	14.82	4.96	14.73	5.11	14.64	5.28	14.55	5.45	14.48	5.64	14.41	5.85	14.34	6.07
	0	17.46	4.91	17.41	4.99	17.31	5.15	17.20	5.31	17.08	5.48	16.97	5.66	16.86	5.85	16.75	6.06
	5	20.11	5.07	20.04	5.14	19.90	5.30	19.75	5.46	19.61	5.63	19.45	5.81	19.29	6.00	19.13	6.20
	10	21.15	5.44	21.10	5.53	21.00	5.71	20.89	5.90	20.80	6.10	20.66	6.30	20.52	6.52	20.38	6.75
	15	22.31	6.18	22.22	6.27	22.04	6.45	21.90	6.65	21.76	6.87	21.64	7.10	21.52	7.35	21.40	7.61

**NOTE**

IPT data considering Outdoor Unit only.

4.5 Correction indoor fan speed factor

4.5.1 Cooling

The tables are based on High speed of indoor fan. To calculate the cooling capacity of medium or low speed of indoor fan, multiply cooling capacity of high speed by correction indoor fan speed factor.

Indoor unit fan speed	Outdoor unit HP
	3 - 6
High	1.00
Medium	0.98
Low	0.95

4.5.2 Heating

The tables are based on High speed of indoor fan. To calculate the cooling capacity of medium or low speed of indoor fan, multiply cooling capacity of high speed by correction indoor fan speed factor.

The tables does not include decreasing capacity by defrosting operation.

Indoor unit fan speed	Outdoor unit HP
	3 - 6
High	1.00
Medium	0.98
Low	0.97

4.6 Piping length correction factor (f_{LC} , f_{LH})

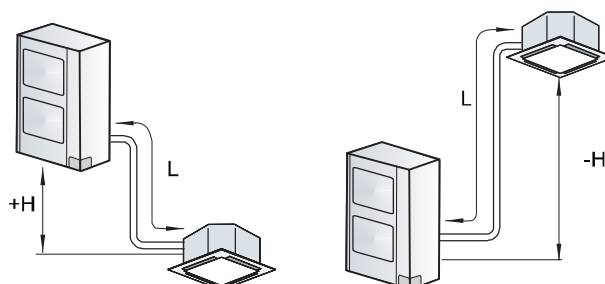

The correction factor is based on the equivalent piping length in meters (EL) and the height between outdoor and indoor units in meters (H).

H: Height between indoor unit and outdoor unit (m).

- $H > 0$: Position of outdoor unit is higher than position of indoor unit (m).
- $H < 0$: Position of outdoor unit is lower than position of indoor unit (m).

L: Actual one-way piping length between indoor unit and outdoor unit (m).

EL: Equivalent one-way piping length between indoor unit and outdoor unit (m).

- One 90° elbow is 0.5 m.
- One 180° bend is 1.5 m.
- One Multi-kit is 0.5 m.



NOTE

In order to ensure correct unit selection, consider the farthest indoor unit.

Cooling

RAS-3HVRC2

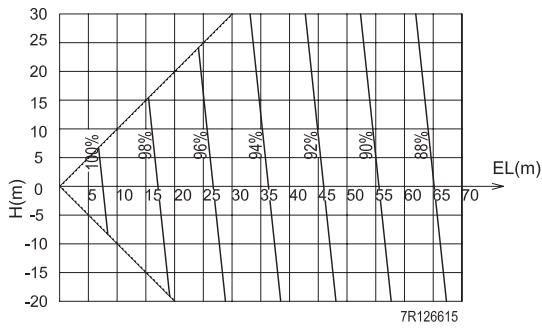

RAS-4H(V)(R/N)(C/P)2E

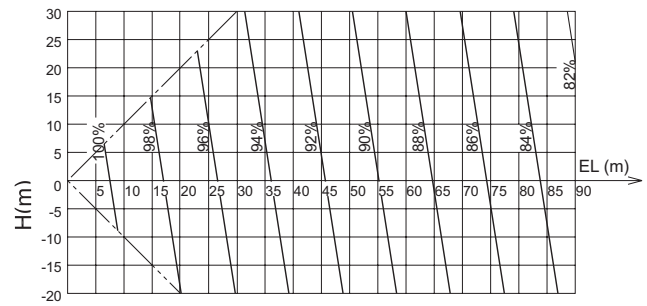

RAS-5H(V)(R/N)(C/P)2E

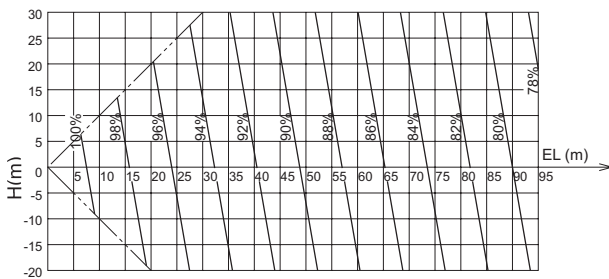

RAS-6H(V)(R/N)(C/P)2E

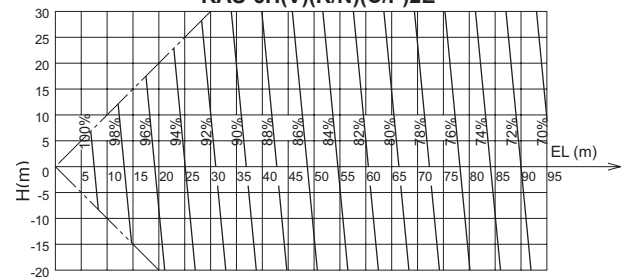

Heating

RAS-3HVRC2

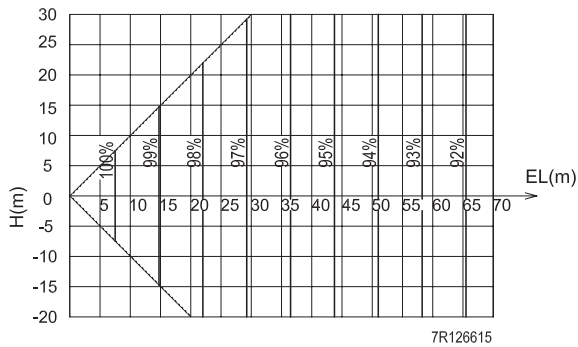

RAS-4H(V)(R/N)(C/P)2E

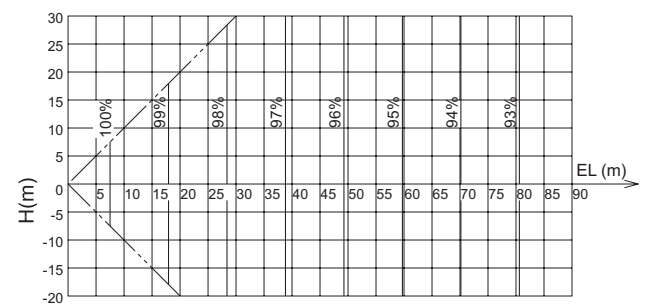

RAS-5H(V)(R/N)(C/P)2E

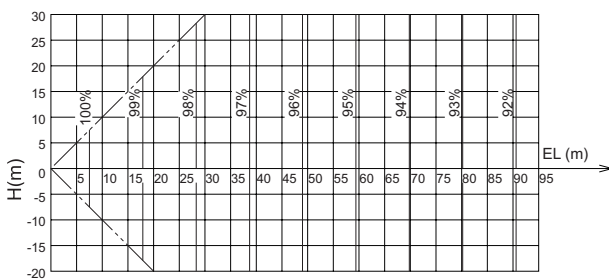

RAS-6H(V)(R/N)(C/P)2E

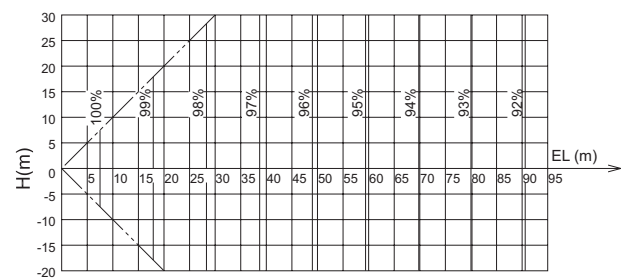

4.7 Defrost Operation correction factor (f_D)

The heating capacity does not include operation during frost or defrosting.

When this type of operation is taken in account, the heating capacity must be corrected according to the following equation:

Correction heating capacity = Correction factor x heating capacity

Outdoor inlet air temperature (°C DB)	-7	-5	-3	0	3	5	7
Correction factor	0.95	0.93	0.88	0.85	0.87	0.90	1.00



NOTE

- Defrost correction factor corresponds to a relative humidity of 85%. If the condition changes, the correction factor will be different.
- Defrost correction factor is not valid for special conditions such as during snow or operation in a transitional period.

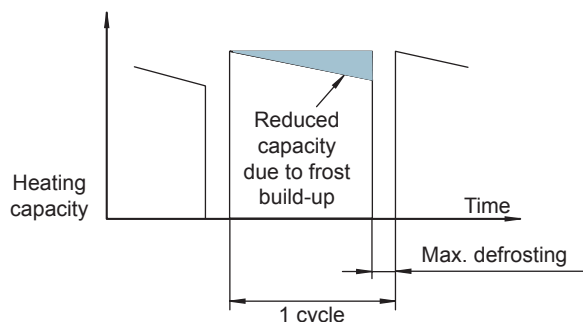

4.8 Correction ratio due to humidity (CR)

The cooling capacity data for the outdoor units is taken from the cooling capacity tables. The tables are calculated on the basis of a relative humidity of 50%.

In some situations, it's possible that the temperature condition of the ambient to be conditioned, specifies other different relative humidity, which affect at the Dry Bulb temperature. In this cases, it's necessary to calculate the difference between the indoor air inlet dry bulb temperature required by the system and the indoor air inlet dry bulb temperature shown in the cooling capacity data.

This temperature difference requires an adjustment of the cooling capacity of the system.

$Q_{AC} = Q_C + (CR \times (DB_R - DB))$

Model	CR
RAS-3HVRC2	0.34
RAS-4H(V)(R/N)(C/P)2E	0.43
RAS-5H(V)(R/N)(C/P)2E	0.51
RAS-6H(V)(R/N)(C/P)2E	0.59

4.9 Correction factor according to altitude (f_{AL})

The capacity is affected by the altitude of the installation location. When the altitude is above sea level, capacity must be corrected with the altitude correction factor according to the following equation:

Correction capacity = Altitude Correction factor x Capacity

Altitude (m)	0	300	600	900	1200	1500	1800	2100	2400	2700	3000
Correction factor	1	0.97	0.94	0.90	0.88	0.84	0.81	0.78	0.75	0.72	0.69

5. Acoustic characteristic curves

Index

5.1	Overall sound level.....	62
5.2	Sound pressure curves	63
5.3	Sound power curves.....	65



5.1 Overall sound level

The overall sound level has been measured in an anechoic chamber so reflected sound should be taken into consideration when installing the unit.

Test Conditions:

- 1 Distance of the unit from the measuring point: 1 meter from the unit's front surface; 1.5 meter from floor level:

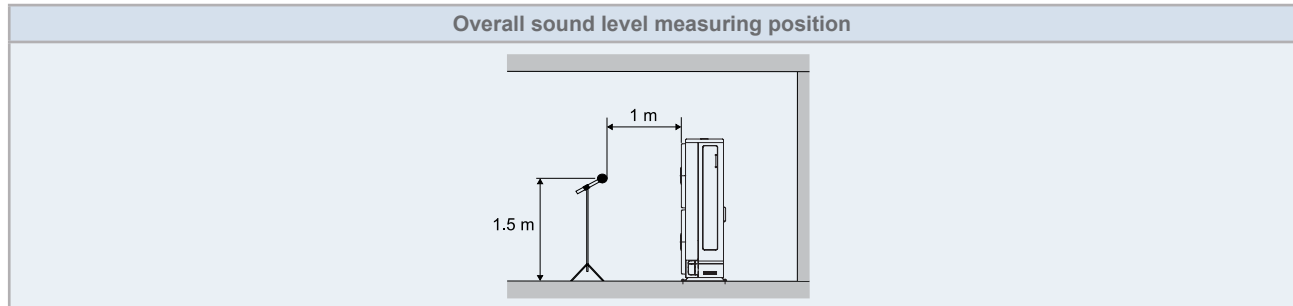

- 2 Power supply:

- a. Single phase units: 1~ 230V 50Hz.
- b. Three phase units: 3N~ 400V 50Hz.

i **NOTE**

The sound data is measured in an anechoic chamber, so reflected sound should be taken into consideration when installing the unit.

5.2 Sound pressure curves

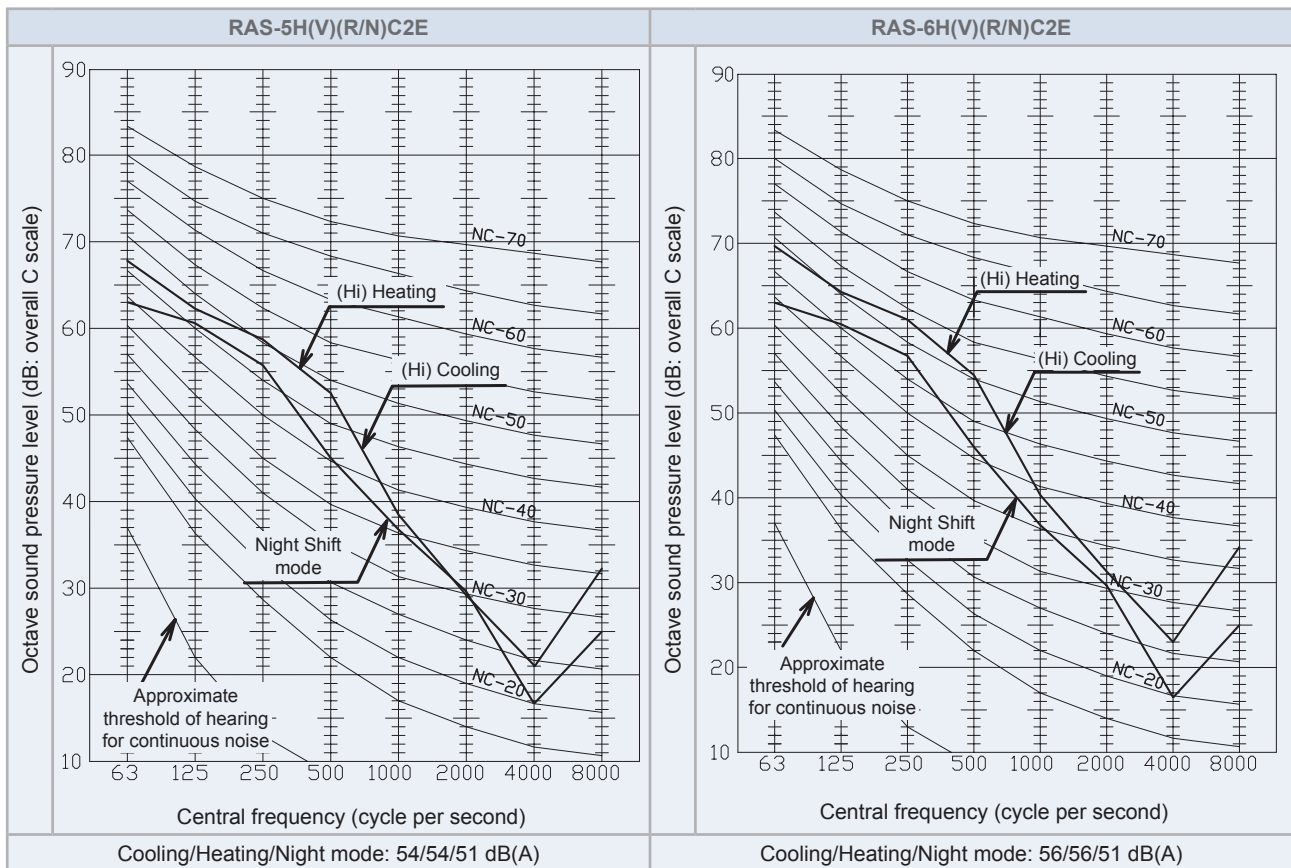
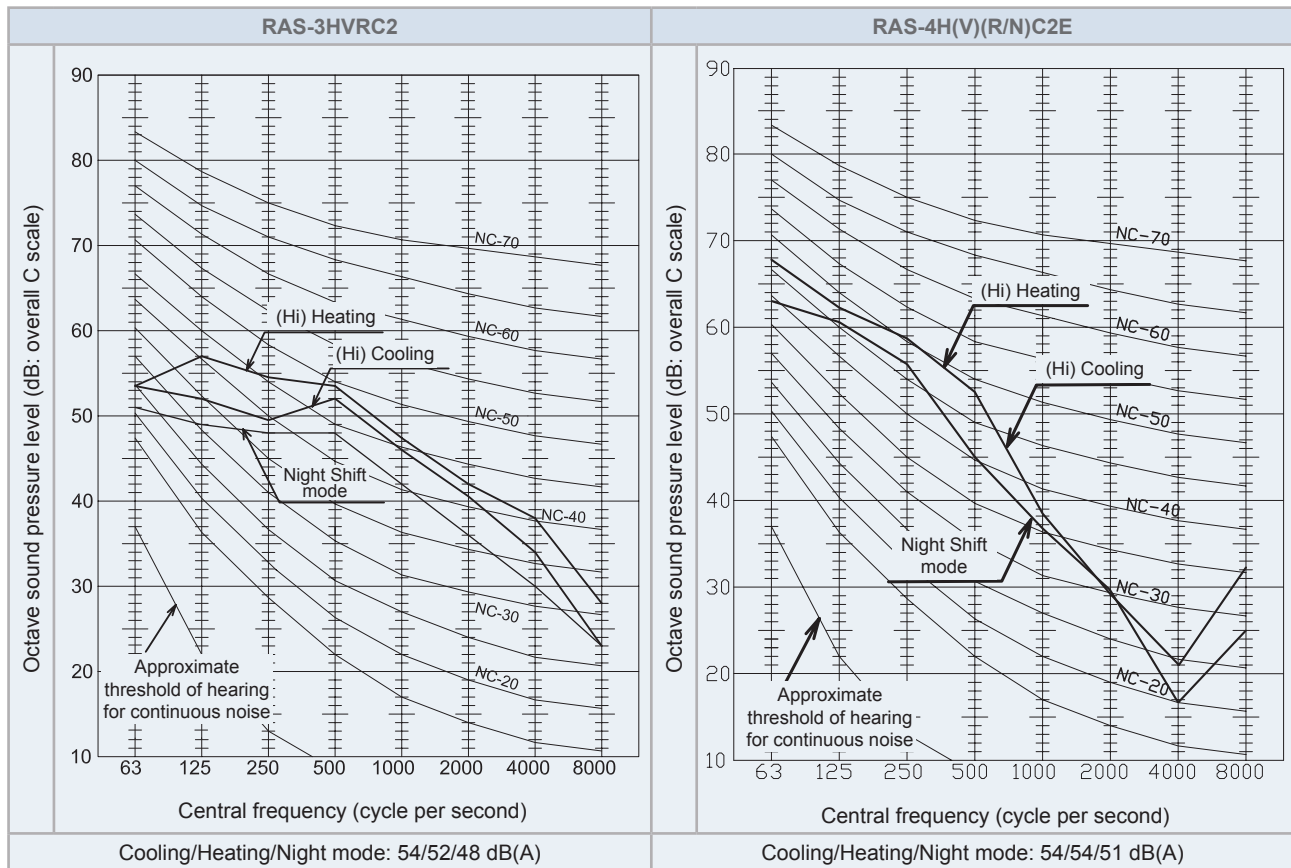

5

Sound pressure curves

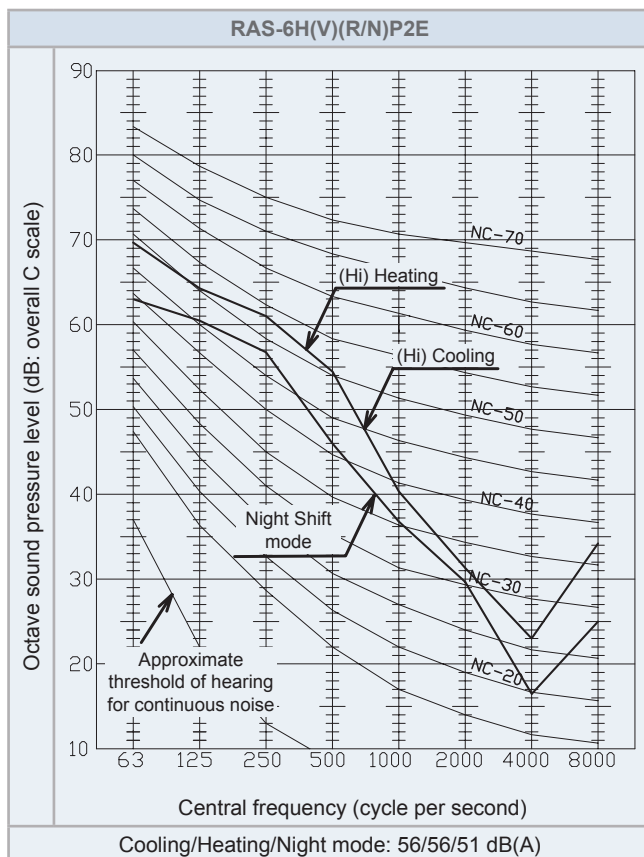
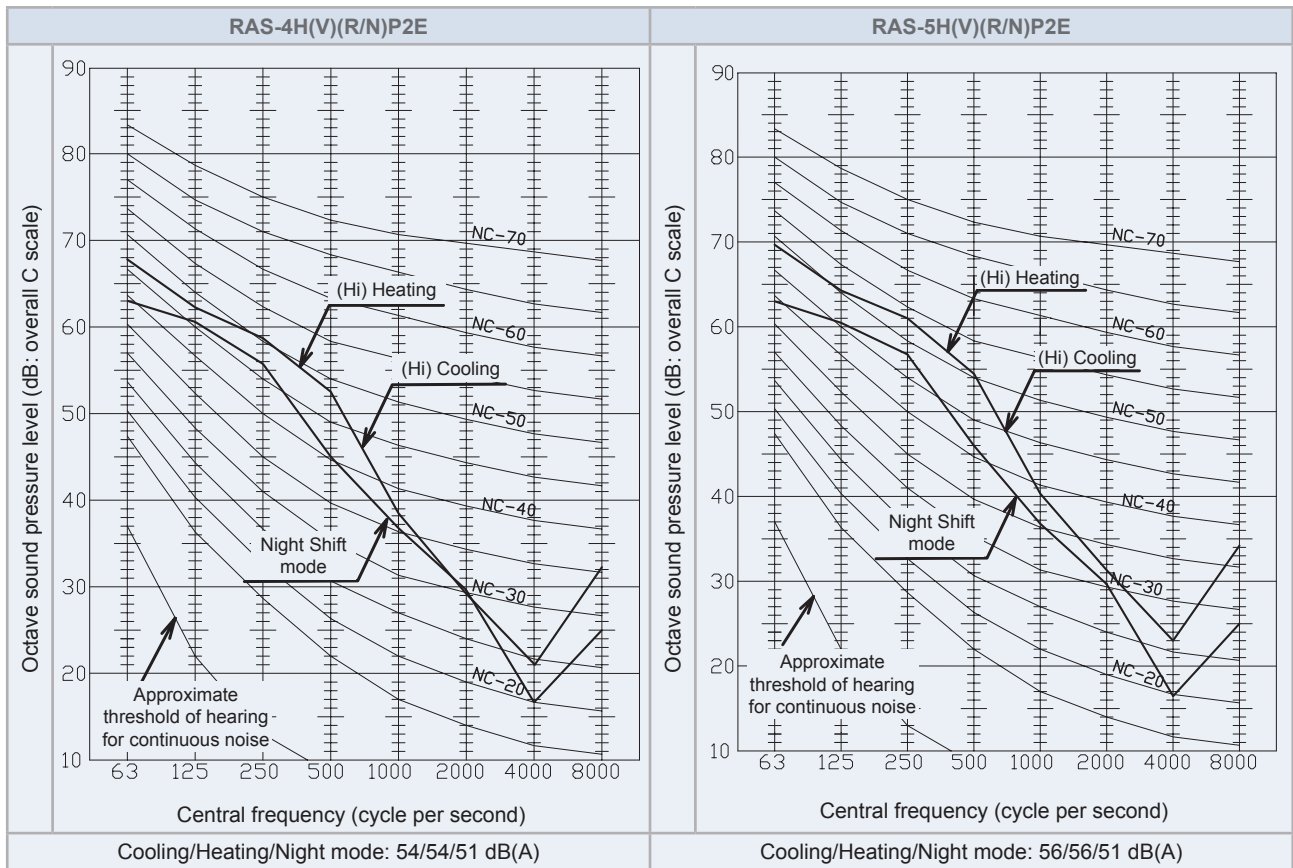

5.3 Sound power curves

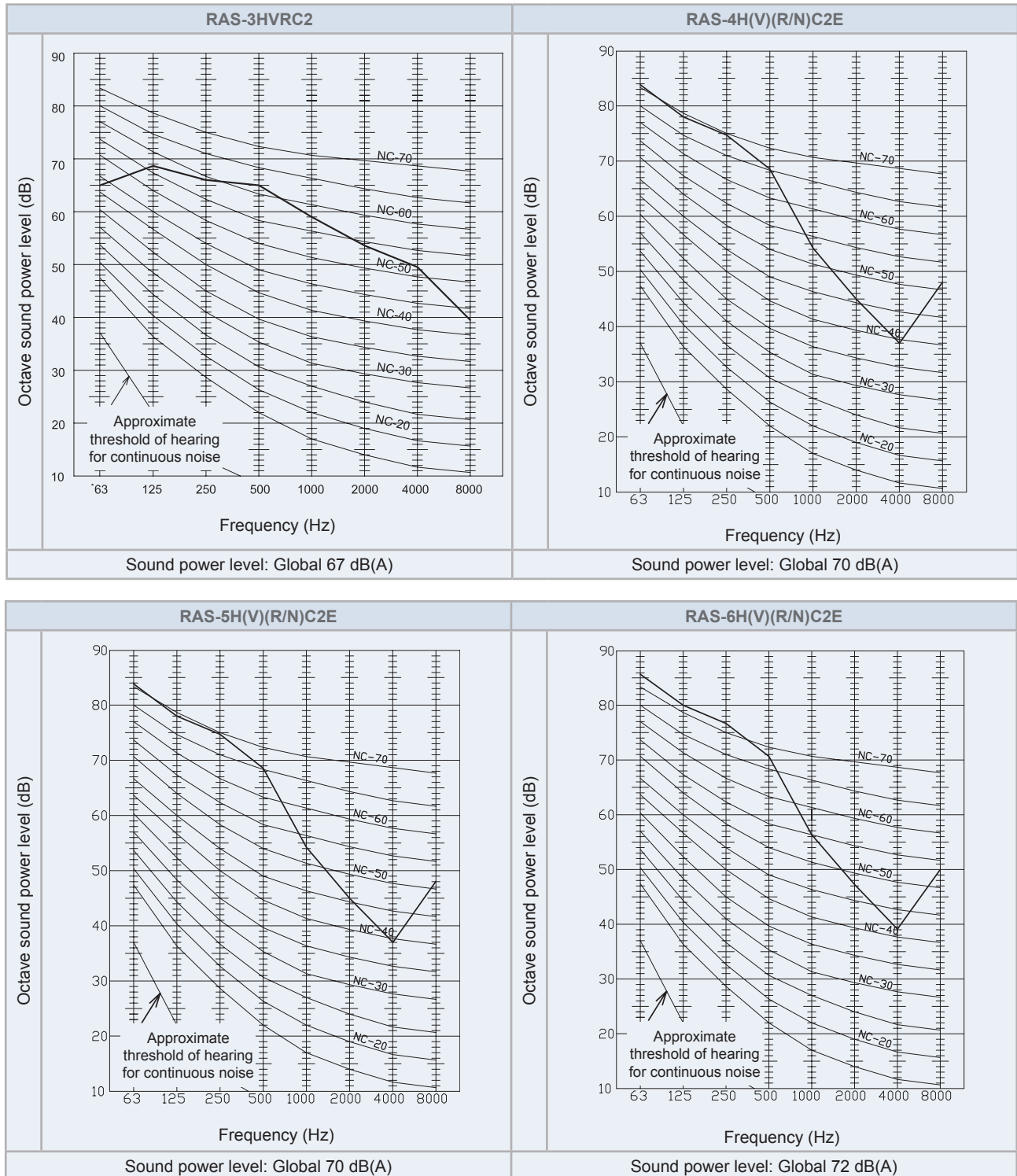

5

Sound power curves

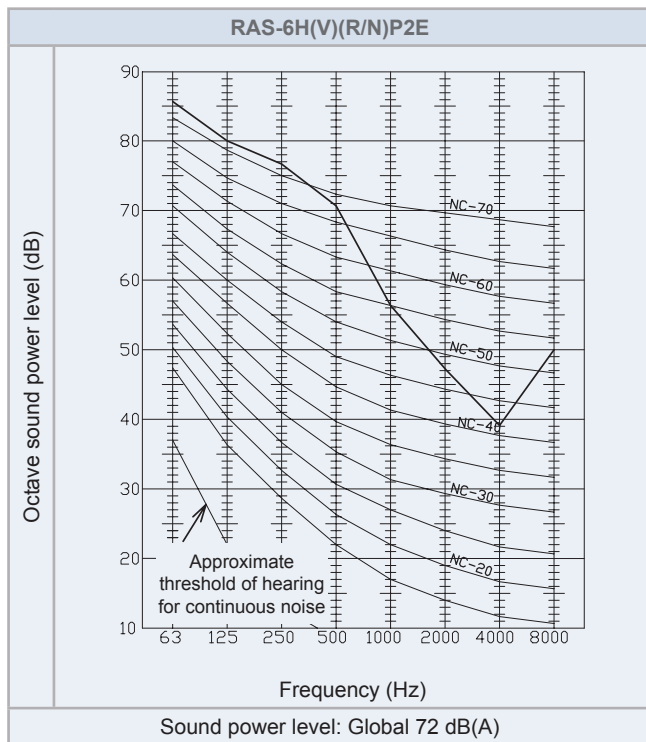
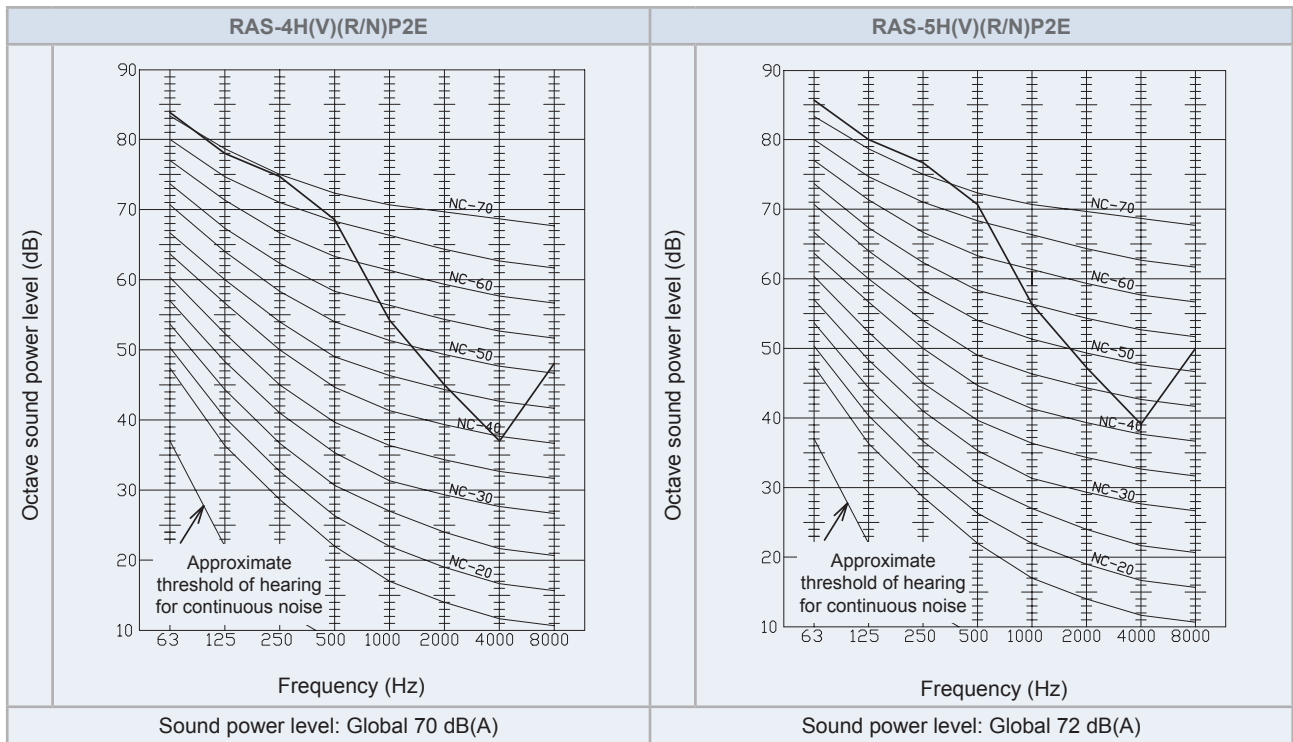

6 . Working range

Index

6.1	Working range	68
6.1.1	Power supply	68
6.1.2	Temperature working range.....	68
6.1.3	Special DSW configuration for low ambient temperature (-15°C) - only for simultaneous operation mode units (UTOPIA Prime).....	69

6.1 Working range

6.1.1 Power supply

Nominal power supply:

Single phase: 1~ 230V 50Hz / Three phase: 3N~ 400V 50Hz

Operating voltage

Between 90 and 110% of the nominal voltage.

Voltage imbalance for nominal power supply 3N~ 400V 50Hz

Up to 3% of each phase, measured at the main terminal of the outdoor unit.

Starting voltage

Always higher than 85% of the nominal voltage.

Relative Humidity limit

Lower than 80%

6.1.2 Temperature working range

The new UTOPIA series has been designed for the following temperatures.

		Cooling mode	Heating mode
Indoor side air inlet temperature	Minimum	21 °C DB / 15 °C WB	15 °C DB
	Maximum	32 °C DB / 23 °C WB	27 °C DB
Outdoor side air inlet temperature	Minimum	-15 °C DB - Simultaneous operation mode -5 °C DB - Individual operation mode	-20 °C WB
	Maximum	46 °C DB - for external static pressure 0Pa, otherwise outdoor temp: 43 °C DB	18 °C WB



NOTE

DB: Dry Bulb; WB: Wet Bulb.

Cooling mode for UTOPIA Prime

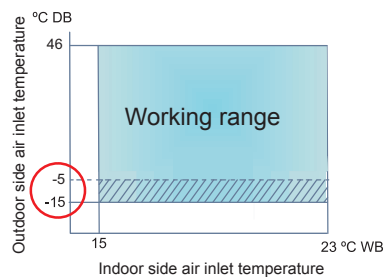

NOTE

The outdoor ambient temperature limit is extended down from -5°C to -15°C under special DSW configuration for low temperature (see chapter 6.1.3 Special DSW configuration for low ambient temperature (-15°C) - only for simultaneous operation mode units (UTOPIA Prime)).

Cooling mode for UTOPIA IVX Prime

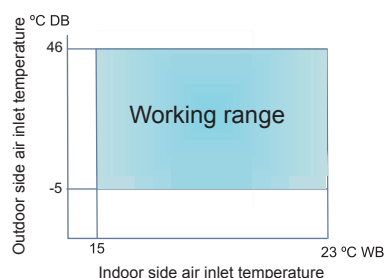

Heating mode

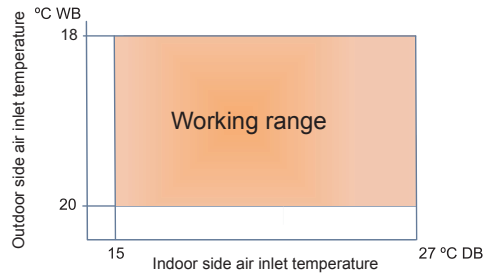

6.1.3 Special DSW configuration for low ambient temperature (-15°C) - only for simultaneous operation mode units (UTOPIA Prime)

The outdoor ambient temperature limit is extended down from -5°C to -15°C under this configuration.

Only when		Mandatory setting (OU)
Cooling mode operation		DSW2 PIN 3 = ON

 NOTE

Capacity and efficiency can vary depending on ambient conditions, working settings, control and protections, etc.

 CAUTION

Additionally, the wind guard must be installed in RAS-3HVRC2 and RAS-(4-6)H(V)(R/N)C2E.

7 . General dimensions

Index

7.1	Dimensions.....	72
7.1.1	RAS-3HVRC2.....	72
7.1.2	RAS-(4-6)H(V)(R/N)(C/P)2E	73
7.2	Service space.....	74
7.2.1	Basic sizes	74
7.2.2	RAS-3HVRC2.....	75
7.2.3	RAS-(4-6)H(V)(R/N)(C/P)2E	77

7.1 Dimensions

7.1.1 RAS-3HVRC2

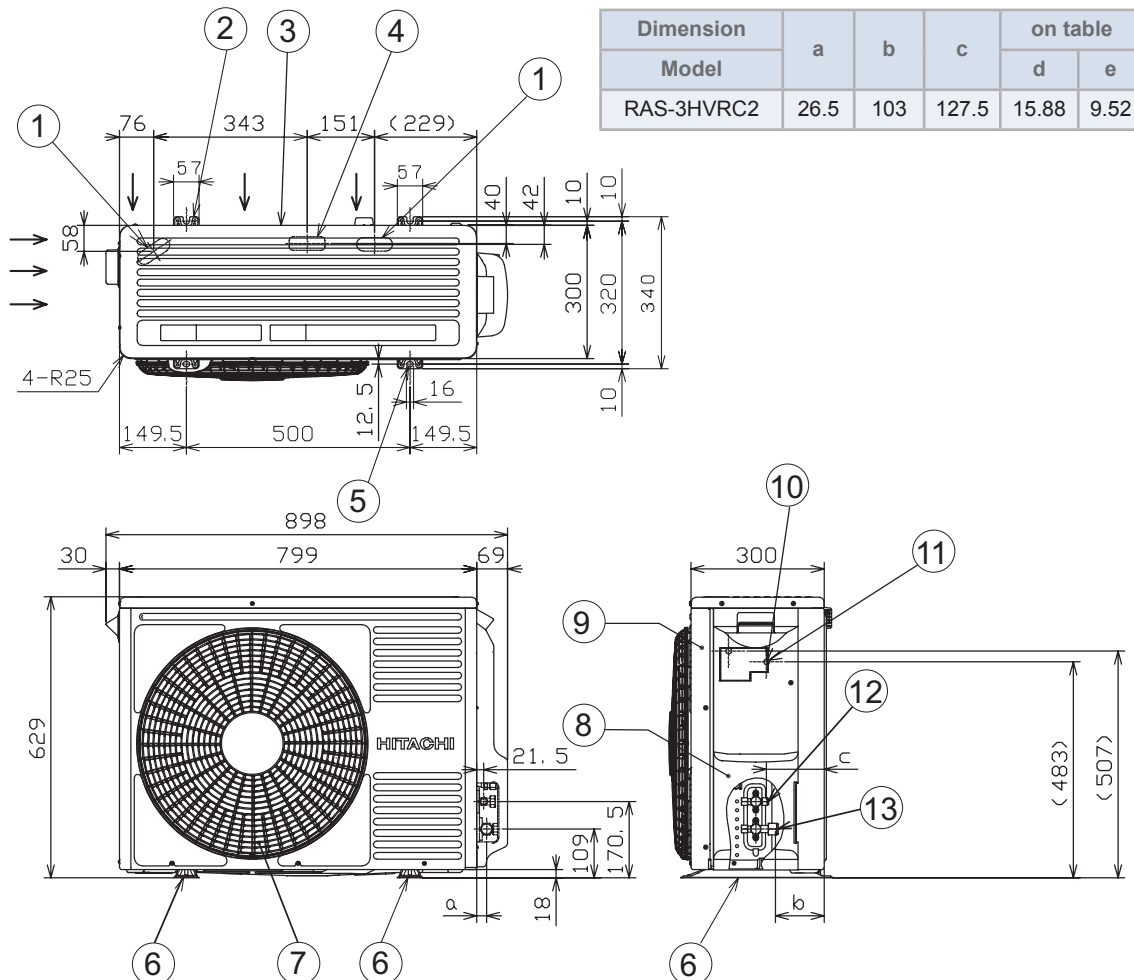

Units in mm.

Number	Description	Remarks
1	Punched drain hole	30x80 long hole
2	Attachment hole for M10 anchor bolt	2-U cut hole
3	Air suction inlet	—
4	Punched drain hole	For drain pipe
5	Attachment hole for M10 anchor bolt	2-Long hole
6	Foot part	
7	Air discharge outlet	—
8	Pipe cover	—
9	Service cover	—
10	Terminal board for power supply and transmission Terminal screw of power supply wire (M5) Terminal screw of transmission wire (M4)	—
11	Terminal screw of earth wire (M5)	—
12	Connection of refrigerant liquid pipe	With flare nut for Øe copper pipe
13	Connection of refrigerant gas pipe	With flare nut for Ød copper pipe

7.1.2 RAS-(4-6)H(V)(R/N)(C/P)2E

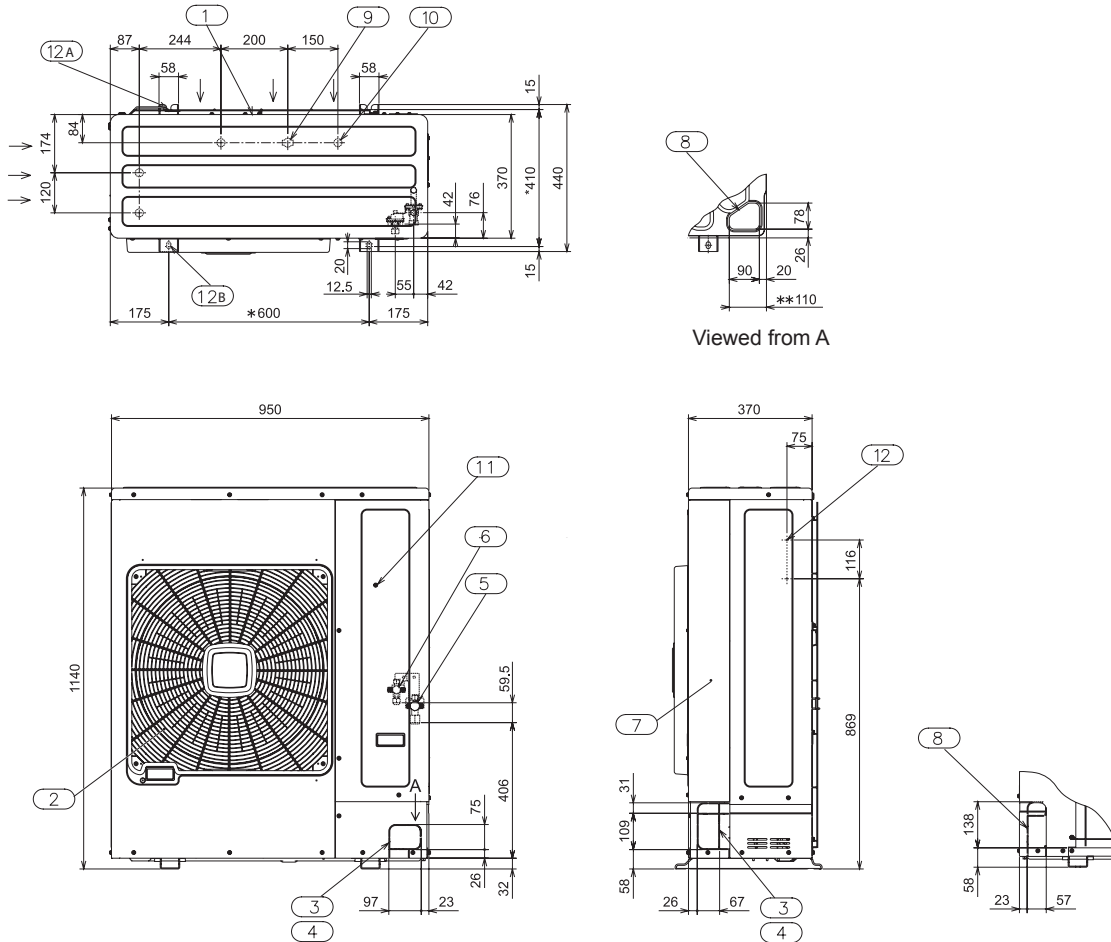

Units in mm.

Number	Description	Remarks
1	Air inlet	—
2	Air outlet	—
3	Holes for power supply wiring	—
4	Holes for control line wiring	—
5	Gas piping connection	—
6	Liquid piping connection	—
7	Service panel	—
8	Refrigerant piping hole	—
9	Drain hole	—
10	Drain hole	—
11	Earth terminal wiring	(M5)
12	Holes for fixing machine to wall	A: 2-U cut holes / B: 2 - holes

7.2 Service space

7.2.1 Basic sizes

◆ RAS-3HVRC2

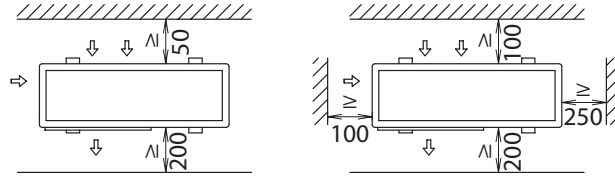

◆ RAS-(4-6)H(V)(R/N)(C/P)2E

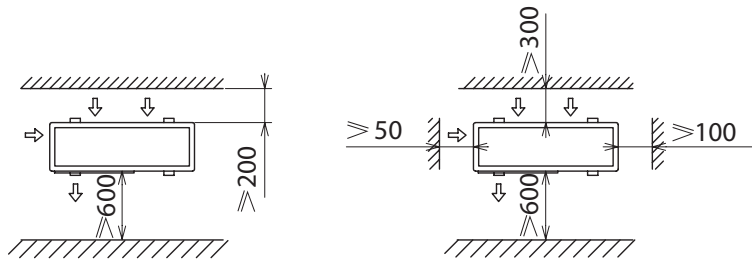

Units in mm.

i NOTE

Please refer to the Service Manual for specific information.

7.2.2 RAS-3HVRC2

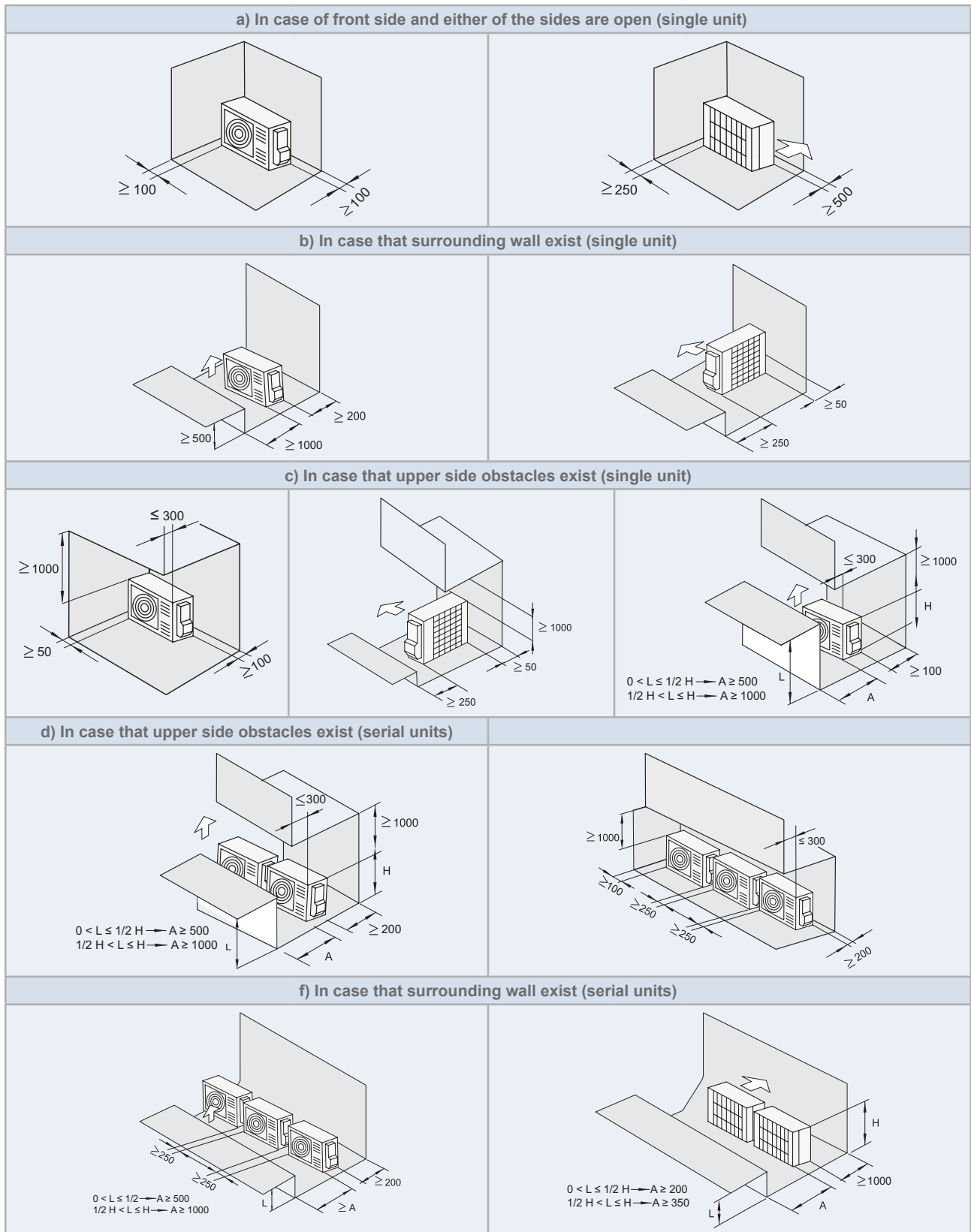

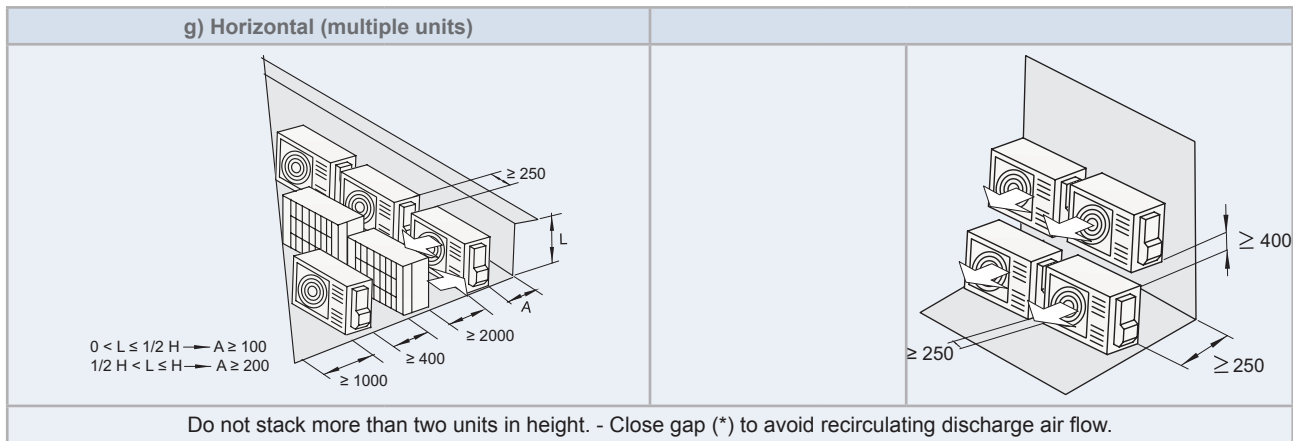

<p>Follow the instructions below to install on the rooftop or a location without surrounding buildings, where strong wind is expected against the product.</p> <p>Choose a location where the outlet or inlet side of the product will not be exposed to strong wind.</p> <p>When the outlet is exposed to strong wind: Direct strong wind may cause lack of air flow and adversely affect to the operation.</p>		<p>⚠ CAUTION</p> <p>Excessive strong wind against the outdoor unit outlet may cause inverse rotation and damage the fan and motor.</p>				
<p>In case of blowing strong wind to air outlet the wind guard (optional) is available to avoid strong wind</p>		<p>Wind guard model</p> <table border="1"> <thead> <tr> <th>Model</th> <th>Number of set required</th> </tr> </thead> <tbody> <tr> <td>WSP-264</td> <td>1</td> </tr> </tbody> </table>	Model	Number of set required	WSP-264	1
Model	Number of set required					
WSP-264	1					
<p>Air flow guide</p>		<p>Air flow guide model</p> <table border="1"> <thead> <tr> <th>Model</th> <th>Number of set required</th> </tr> </thead> <tbody> <tr> <td>AG-264</td> <td>1</td> </tr> </tbody> </table>	Model	Number of set required	AG-264	1
Model	Number of set required					
AG-264	1					

i NOTE

- The wind guard must be set at annual cooling operation (in DSW2 switch 3).
- For ambient temperature ≤ 10°C, it is recommended to set the wind guard at cooling operation.

7.2.3 RAS-(4-6)H(V)(R/N)(C/P)2E

(Unit: mm)

Blocked in Inlet Side	
Upper Side Open	
Single Installation	Multiple Installation (Two units or more)
Upper Side Blocked	
Single Installation	Multiple Installation (Two units or more)
Outlet Side Blocked	
Upper Side Open	
Single Installation	Multiple Installation (Two units or more)

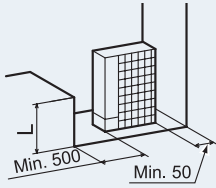
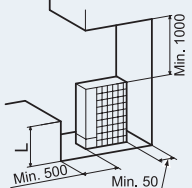
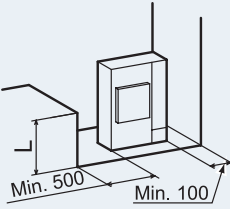
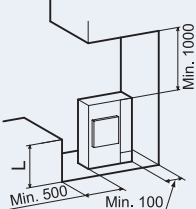
Right and Left Blocked	
Upper Side Open	Upper Side Blocked
Single Installation	
	
	

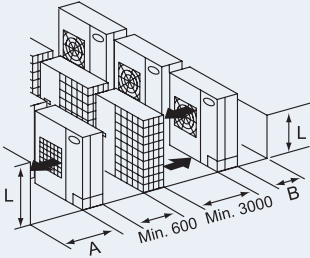
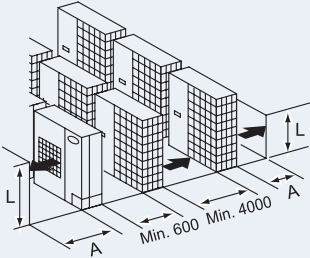
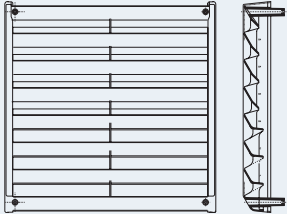
Multi-Row and Multiple Installations															
															
Mount the airflow guide and provide sufficient space on both right and left sides.		When using airflow guide (AG-335A, optional), check that the discharged air is not short-circuited to the air inlet side.													
<table border="1"> <thead> <tr> <th colspan="2">A</th> <th colspan="2">B</th> </tr> </thead> <tbody> <tr> <td>$0 < L \leq 1/2H$</td> <td>$1/2H < L \leq H$</td> <td>$0 < L \leq 1/2H$</td> <td>$1/2H < L \leq H$</td> </tr> <tr> <td>Min. 600</td> <td>Min. 1400</td> <td>Min. 300</td> <td>Min. 350</td> </tr> </tbody> </table>		A		B		$0 < L \leq 1/2H$	$1/2H < L \leq H$	$0 < L \leq 1/2H$	$1/2H < L \leq H$	Min. 600	Min. 1400	Min. 300	Min. 350	When $L > H$ use a base for outdoor unit to make $L \leq H$. Close the base not to allow the outlet air bypassed.	
A		B													
$0 < L \leq 1/2H$	$1/2H < L \leq H$	$0 < L \leq 1/2H$	$1/2H < L \leq H$												
Min. 600	Min. 1400	Min. 300	Min. 350												

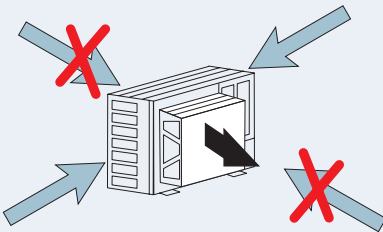
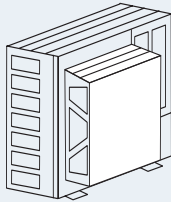
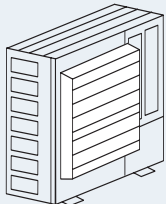
<p>Follow the instructions below to install on the rooftop or a location without surrounding buildings, where strong wind is expected against the product.</p> <p>Choose a location where the outlet or inlet side of the product will not be exposed to strong wind.</p> <p>When the outlet is exposed to strong wind: Direct strong wind may cause lack of air flow and adversely affect to the operation.</p>		<p>⚠ CAUTION</p> <p>Excessive strong wind against the outdoor unit outlet may cause inverse rotation and damage the fan and motor.</p>				
<p>In case of blowing strong wind to air outlet the wind guard (optional) is available to avoid strong wind</p>		<p>Wind guard model</p> <table border="1"> <thead> <tr> <th>Model</th> <th>Number of set required</th> </tr> </thead> <tbody> <tr> <td>WSP-335A</td> <td>1</td> </tr> </tbody> </table>	Model	Number of set required	WSP-335A	1
Model	Number of set required					
WSP-335A	1					
<p>Air flow guide</p>		<p>Air flow guide model</p> <table border="1"> <thead> <tr> <th>Model</th> <th>Number of set required</th> </tr> </thead> <tbody> <tr> <td>AG-335A</td> <td>1</td> </tr> </tbody> </table>	Model	Number of set required	AG-335A	1
Model	Number of set required					
AG-335A	1					

8 . Refrigerant cycle

Index

8.1	General notes.....	80
8.2	RAS-3HVRC2.....	80
8.3	RAS-(4-6)H(V)(R/N)(C/P)2E	81

8.1 General notes

Mark	Part name
A	Gas line refrigerant piping connection
B	Liquid line refrigerant piping connection
C	Outdoor unit

8.2 RAS-3HVRC2

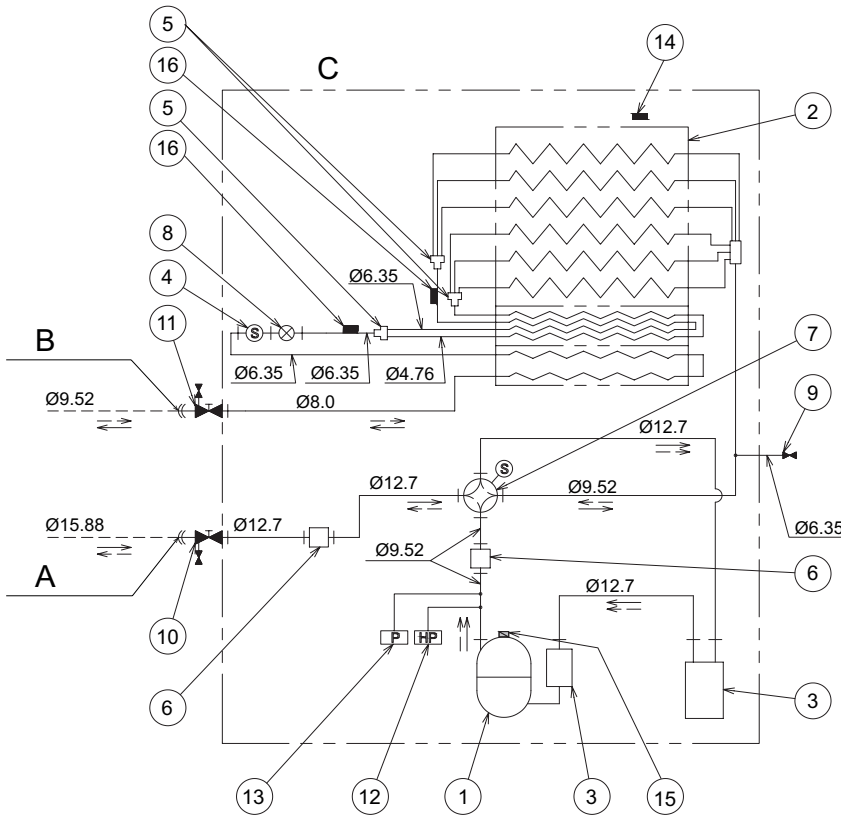

Nº	Part name
1	Compressor
2	Air side heat exchanger
3	Accumulator
4	Refrigerant strainer
5	Distributor
6	Silencer
7	4-way valve
8	OU electronic expansion valve
9	Refrigerant check joint
10	Stop valve for gas line
11	Stop valve for liquid line
12	High pressure switch for protection
13	Pressure switch for control
14	Ambient thermistor
15	Discharge gas thermistor
16	Pipe thermistor

						Refrigerant
Heating refrigerant flow	Cooling refrigerant flow	Water flow (Heating/ Cooling)	Field supplied piping line	Flare nut connection	Brazed connection	R32

G0000069481

8.3 RAS-(4-6)H(V)(R/N)(C/P)2E

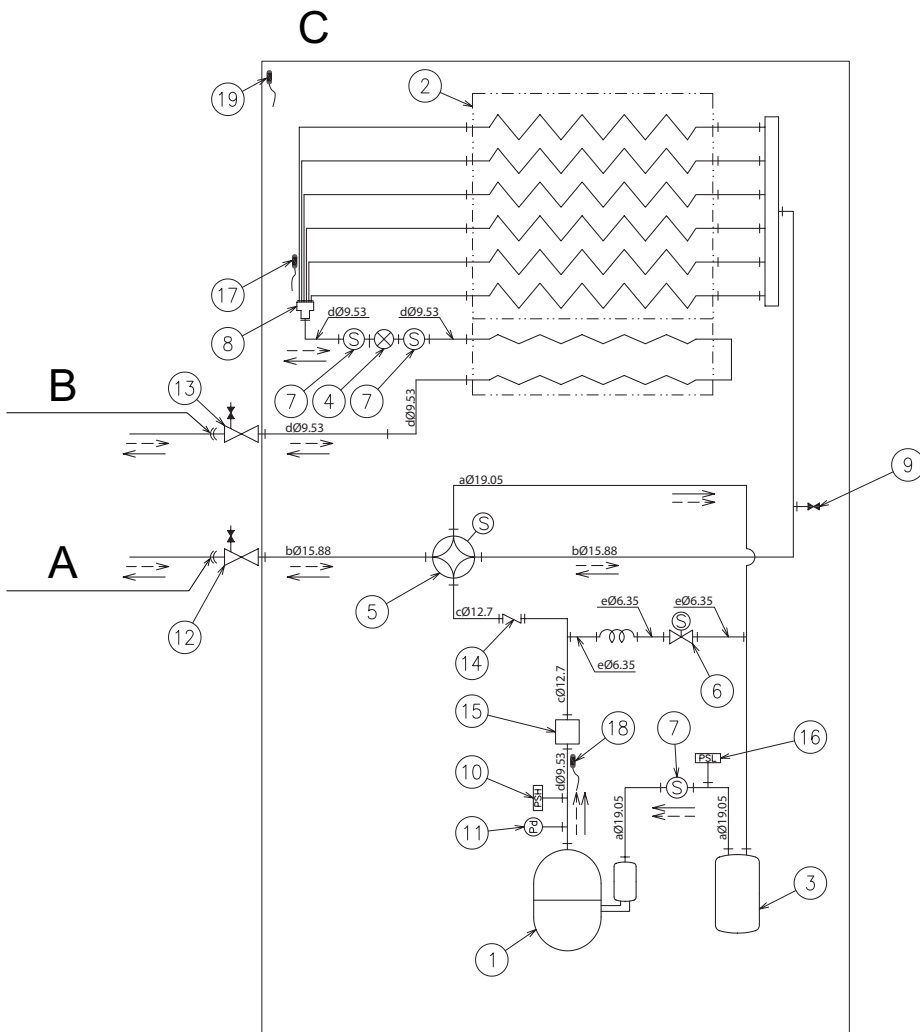

N°	Part name
1	Compressor
2	Air side heat exchanger
3	Accumulator
4	Micro-computer controlled expansion valve
5	4-way valve
6	Solenoid valve for gas bypass
7	Strainer
8	Distributor
9	Check joint
10	High pressure switch for protection
11	Pressure sensor (High pressure control)
12	Stop valve for gas line
13	Stop valve for liquid line
14	Check valve
15	Silencer
16	Pressure switch (Low pressure control)
17	Liquid pipe thermistor (Te)
18	Discharge gas thermistor (Td)
19	Ambient thermistor (Ta)

Mark	ODxT	Material
a	19.05Dx1.2T	C1220T-0
b	15.88Dx1.0T	
c	12.7Dx1.0T	
d	9.53Dx0.8T	
e	6.35Dx1.07T	

OD: Outer Diameter (mm)

T: Thickness (mm)

←	---	⇨	---	⇨	+	Refrigerant
Heating refrigerant flow	Cooling refrigerant flow	Water flow (Heating/ Cooling)	Field supplied piping line	Flare nut connection	Brazed connection	R32 R410A

XEKS2000

9. Piping work and refrigerant charge

Index

9.1	Refrigerant pipe selection.....	84
9.1.1	Pipe size selection.....	84
9.1.2	Multikit or distributor selection	84
9.2	Refrigerant piping range.....	84
9.2.1	Refrigerant piping length	84
9.2.2	Piping system for header branch.....	85
9.2.3	Maximum length of refrigerant piping	86
9.2.4	Combinations of piping size and piping length	88
9.2.5	Refrigerant piping size and multikit/distributor.....	88
9.3	Copper pipes, sizes and connection	90
9.3.1	Copper pipes and sizes.....	90
9.3.2	Insulation.....	91
9.4	Refrigerant charge amount.....	92
9.4.1	Refrigerant charge before shipment (W_0 (kg)).....	92
9.4.2	Calculation method for the additional refrigerant charge.....	92
9.5	Caution in case of refrigerant leakage.....	94
9.5.1	Maximum permitted concentration of hydrofluorocarbon (HFC)	94
9.5.2	Calculation of refrigerant concentration.....	94
9.5.3	Countermeasure for R410A refrigerant leakage.....	95

9.1 Refrigerant pipe selection

9.1.1 Pipe size selection

Select the pipe size in line with the following instructions:

- 1 Between the outdoor unit and the branch pipe (multikit): select the same pipe connection size as for the outdoor unit.
- 2 Between the branch pipe (multikit) and the indoor unit: select the same pipe connection size as for the indoor unit.
- 3 Between branch pipes (multikits): select the pipe connection size according the equivalent indoor unit size if adding up the units after the branch pipe.

CAUTION

- Do not use refrigerant pipe sizes other than those indicated in this Technical Catalogue. The diameter of the refrigerant pipes depends directly on the outdoor unit capacity.
- If larger diameter gas refrigerant pipes are used, the circuit lubrication oil tends to separate from the gas carrying it. The compressor will be seriously damaged due to a lack of lubrication.
- If smaller diameter gas refrigerant pipes are used, the gas or liquid refrigerant will have serious difficulties in circulating. System performance will be affected. The compressor will run under more severe conditions than foreseen and will be damaged in a short space of time.

9.1.2 Multikit or distributor selection

Pipe connection size on outdoor units, indoor units and the multikit or distributor vary according to the system.

The sizes of the indoor and outdoor units could be different.

9.2 Refrigerant piping range

9.2.1 Refrigerant piping length

The refrigerant piping between the indoor unit and the outdoor unit should be designed using the following chart.

Keep the design point within the area of the chart, which is showing the applicable height difference according to piping length.

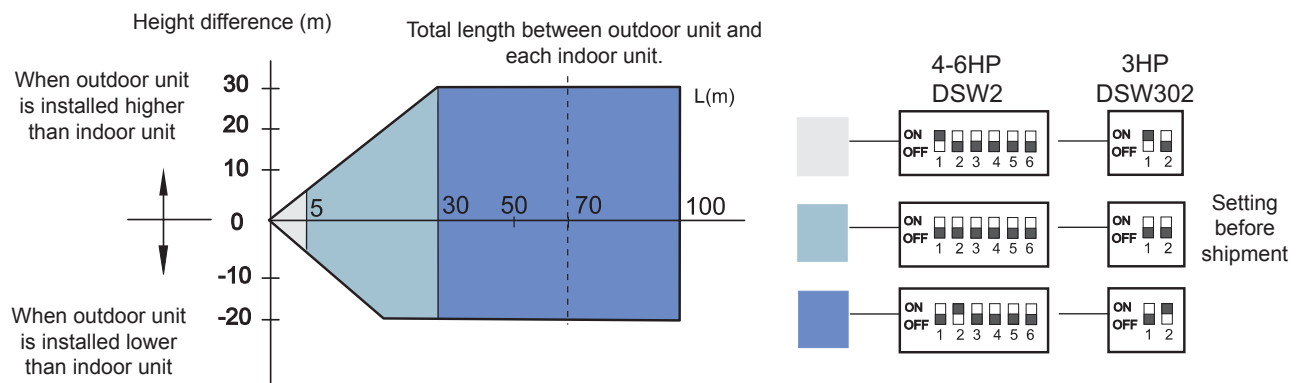

9.2.2 Piping system for header branch

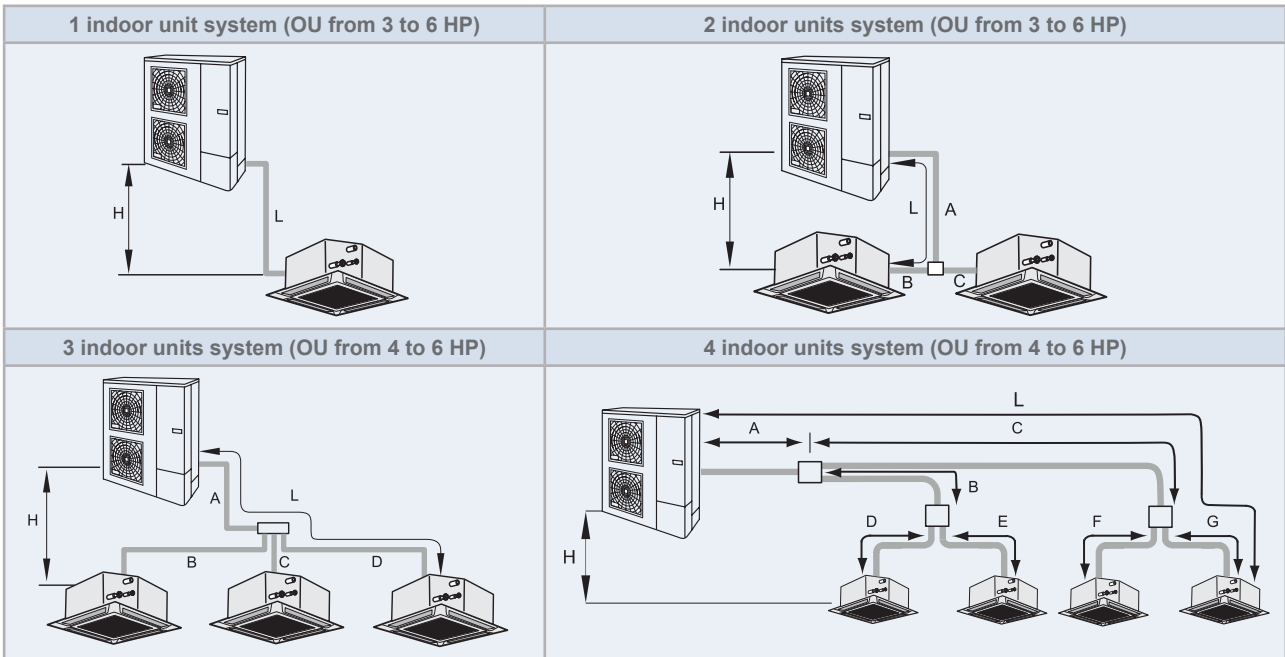

(diagrams are shown as an example)

9.2.3 Maximum length of refrigerant piping

(m)

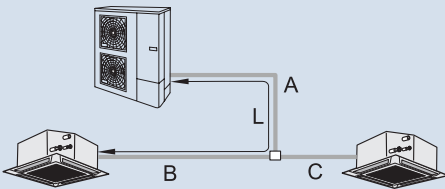
Outdoor Unit		3 HP	4 HP	5 HP	6 HP	
Maximum piping length between the outdoor unit and the farthest indoor unit	Actual length (L)	50	75			
	Equivalent length (EL)	70	95			
Total piping length	2 units (A+B+C)	50	85			
	3 units (A+B+C+D)	--	85			
	4 units (A+B+C+D+E+F+G)	--	85			
Maximum piping line after first branch	2 units (B, C)	15	15			
	2 and 3 units (B, C, D)	--	15			
	4 units (B+D, B+E, C+F, C+G)	--	15			
Maximum height difference, Outdoor / Indoor (H) (Outdoor Unit is higher / lower)		30 / 20				
Maximum height difference Indoor / Indoor		3				
Maximum height difference: branch pipe/indoor (2,3 and 4 indoor units system) branch pipe/branch pipe (4 indoor units system)		3				
Maximum length difference of the several branches:		< 8	< 10			
(B-C) (2 and 3 unit system)	<p><i>Example:</i></p> 					
(B-D) (3 unit system)						
(C-D) (3 unit system)						
(C+G)-(C+F) (4 unit system)						
(B+E)-(B+D) (4 unit system)						
(C+G)-(B+E) (4 unit system)						
(C+G)-(B+D) (4 unit system)						
(C+F)-(B+E) (4 unit system)						
(C+F)-(B+D) (4 unit system)						



NOTE

- The liquid piping and the gas piping must be of the same piping length and run along the same route.
- Install the branch piping as much as possible near the indoor units.
- Install Multi-Kits at the same horizontal level.

◆ Maximum height difference (clarification)

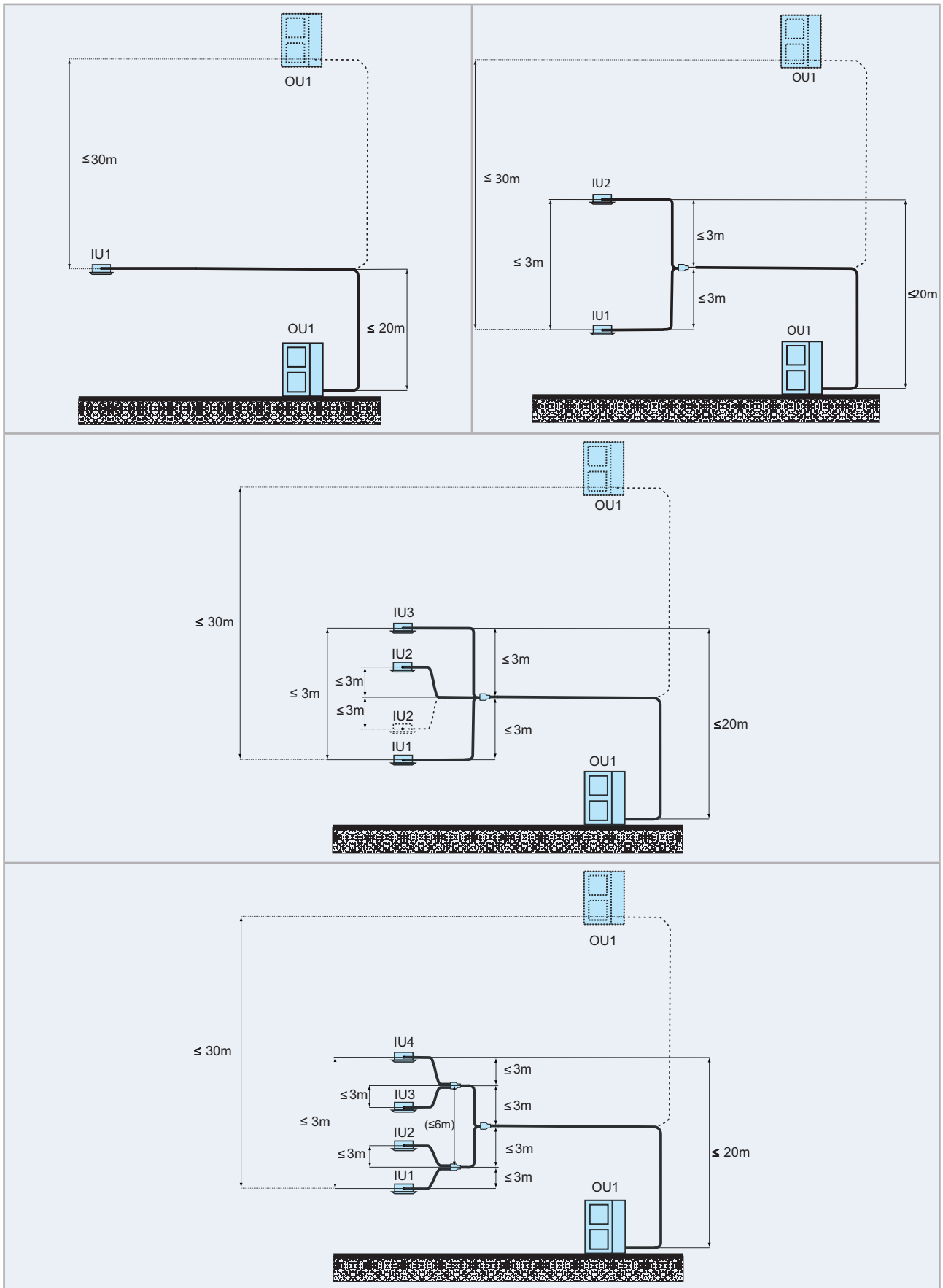

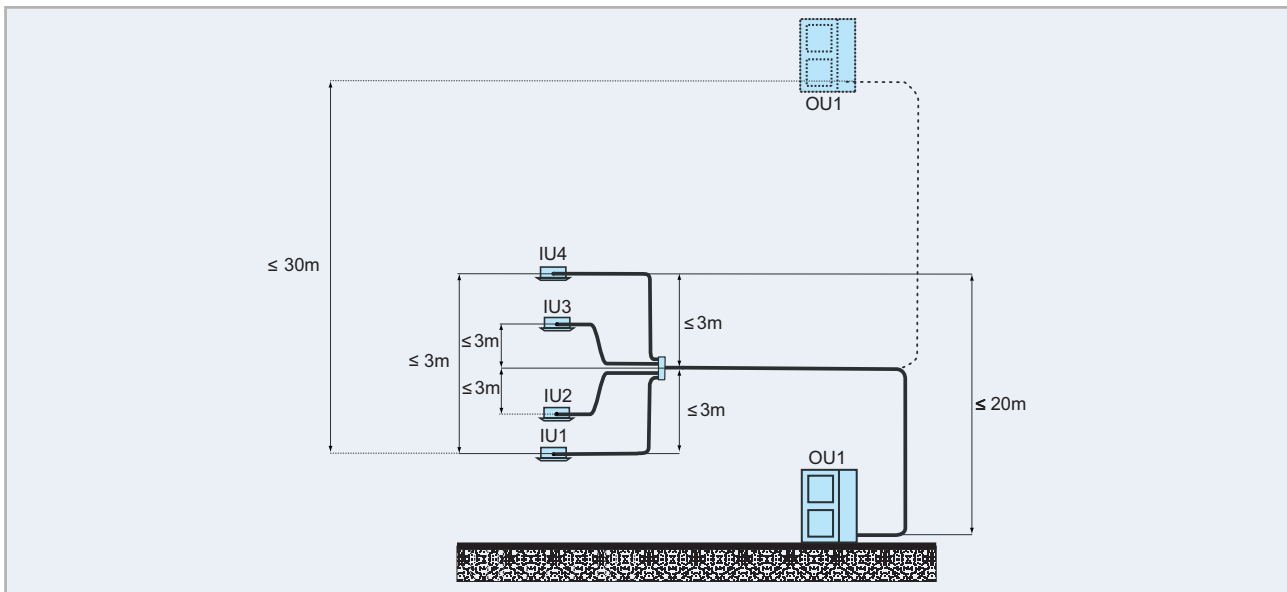

i NOTE

All pictures are as example. Branch and headers are not showed as real sizes or real picture, for the installation of this components follow the technical documentation.

9.2.4 Combinations of piping size and piping length

Liquid	Ø6.35				Ø9.52					Ø12.70				Ø15.88			
	Ø9.52	Ø12.70	Ø15.88	Ø19.05	Ø12.70	Ø15.88	Ø19.05	Ø22.20	Ø25.40	Ø15.88	Ø19.05	Ø22.20	Ø25.40	Ø28.58	Ø22.20	Ø25.40	Ø28.58
3 HP	-	30 ⁽¹⁾⁽²⁾	30 ⁽²⁾	-	30 ⁽¹⁾	50	-	-	-	-	-	-	-	-	-	-	-
4 - 5 - 6 HP	-	-	5 ⁽²⁾	5 ⁽²⁾	40 ⁽¹⁾	75	50 ⁽⁴⁾	-	-	30 ⁽³⁾	30 ⁽³⁾⁽⁴⁾	-	-	-	-	-	-

- (1). Reducing gas pipe size will lower cooling capacity due to larger pressure loss in gas piping and narrow operation range.
- (2). Reducing liquid pipe size will narrow operation range due to indoor unit relation with expansion valve capacity.
- (3). Increasing liquid pipe size will require additional refrigerant charge.
- (4). When using Ø19.05 gas pipe (soft-annealed), please switch ON DSW2-4# in the Outdoor Unit PCB.

Default combination

9.2.5 Refrigerant piping size and multikit/distributor

Select the piping connection sizes according to the following procedures

- Between outdoor unit and branch pipe: Select the same pipe connection size as the pipe size of the outdoor unit.
- Between branch pipe and indoor unit: Select the same pipe connection size as the pipe size of the indoor unit.

1 indoor unit system

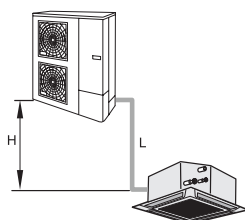

Outdoor Unit HP	Pipe Size (L)	
	Gas	Liquid
3 - 6	Ø15.88	Ø9.52

2 indoor units system

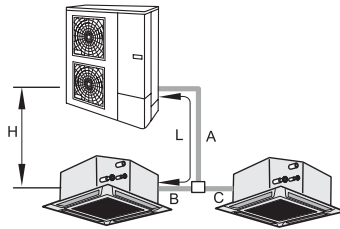

(mm)

Outdoor Unit HP	Pipe Size (A)		Branch pipe
	Gas	Liquid	
3 - 6	Ø15.88	Ø9.52	E-102SN4

(mm)

Indoor unit capacity	Pipe Size (B, C)	
	Gas	Liquid
≤ 1.5 HP	Ø12.70	Ø6.35
1.8/2.0HP	Ø15.88	Ø6.35
≥ 2.3 HP	Ø15.88	Ø9.52

Connections including Indoor Units 8 and 10 HP are not possible

3 indoor units system

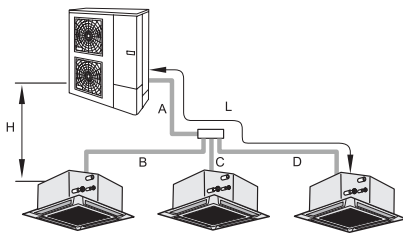

(mm)

Outdoor Unit HP	Pipe Size (A)		Header Branch
	Gas	Liquid	
4 / 5 / 6	Ø15.88	Ø9.52	MH-84AN1

(mm)

Indoor unit capacity	Pipe Size (B, C, D)	
	Gas	Liquid
≤ 1.5 HP	Ø12.70	Ø6.35
1.8/2.0HP	Ø15.88	Ø6.35
≥ 2.3 HP	Ø15.88	Ø9.52

4 indoor units system

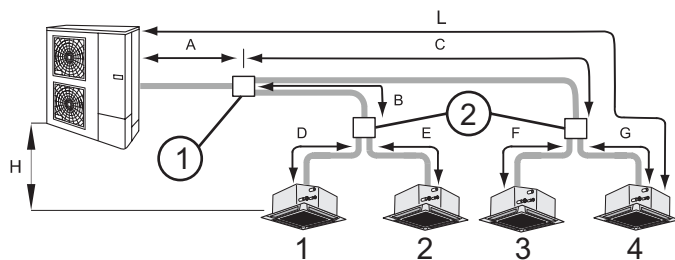

(mm)

Outdoor Unit HP	Pipe Size (A)		Branch pipe ①
	Gas	Liquid	
4 / 5 / 6	Ø15.88	Ø9.52	E-102SN4

(mm)

Total Indoor Unit capacity after branch pipe 1+2 or 3+4	Pipe Size (B, C)		Branch line ②
	Gas	Liquid	
≤ 1.5 HP	Ø12.70	Ø6.35	E-102SN4
from 1.8 to 2.0 HP	Ø15.88	Ø6.35	E-102SN4
≥ 2.3 HP	Ø15.88	Ø9.52	E-102SN4

Indoor Unit capacity	Pipe Size (D, E, F, G)	
	Gas	Liquid
≤ 1.5 HP	Ø12.70	Ø6.35
1.8/2.0HP	Ø15.88	Ø6.35
≥ 2.3 HP	Ø15.88	Ø9.52

i NOTE

Recommended capacity ratio for 4 indoor units system:

Capacity indoor unit 1+2 / Capacity 1+2+3+4 < 60%

Capacity indoor unit 3+4 / Capacity 1+2+3+4 < 60%

If the capacity ratio of branch of indoor units 1 and 2 is bigger than 60 % of total capacity of the system or capacity ratio of branch of indoor unit 3 and 4 is bigger than 60 % of total capacity of the system, please contact with your Hitachi Dealer or Hitachi Customer Service Department.

9.3 Copper pipes, sizes and connection

9.3.1 Copper pipes and sizes

- 1 Prepare locally-supplied copper pipes.
- 2 Select the pipe size of a suitable thickness and material. Use the table below to select the required piping.

Nominal diameter (according to European Standards EN-12735-1)		Minimum thickness (mm)	Copper type
(mm)	(in.)		
Ø6.35	1/4	0.80	Coil (Soft)
Ø9.52	3/8	0.80	Coil (Soft)
Ø12.70	1/2	0.80	Coil (Soft)
Ø15.87	5/8	1.00	Straight lengths (half hard) / Coil (Soft)
Ø19.05	3/4	1.00	Coil (Soft)

- 3 Select clean copper pipes. Make sure there is no dust and moisture inside. Blow the inside of the pipes through with oxygen-free nitrogen to remove any dust and foreign materials before connecting pipes.
- 4 After connecting the refrigerant piping, seal the open space between the knockout hole and refrigerant pipes by using insulation material as shown below:

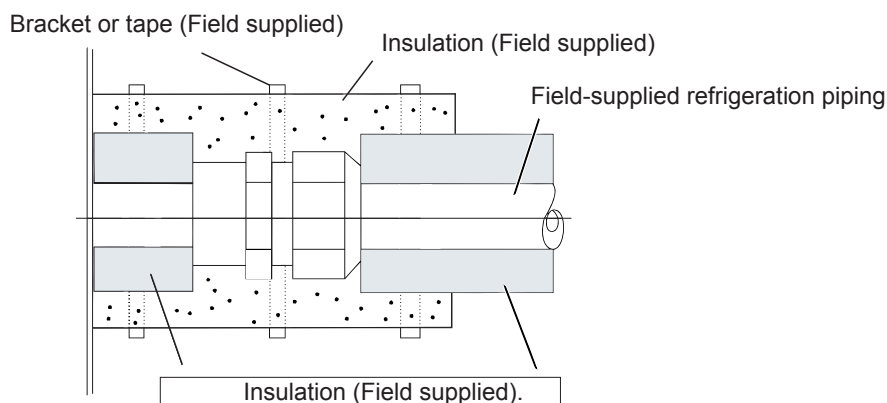

i NOTE

- Do not use saws, grindstone or other tools which might create copper dust.
- When cutting pipes, secure the part to be soldered as shown in the Service Manual.
- Strictly follow national or local regulations regarding occupational health and safety.
- Wear appropriate means of protection during cutting or brazing operations and installation (gloves, eye protection, etc).

i NOTE

- A system with no moisture or oil contamination will give maximum performance and life-cycle as compared with a poorly prepared system. Take particular care to ensure that all copper piping is clean and dry internally.
- To ensure this, blow oxygen free nitrogen through the pipes.

! CAUTION

- Cap the end of the pipe when the pipe is to be inserted through a hole.
- Do not place pipes directly on the ground without a cap or vinyl tape covering the end, as it shown in the figure.

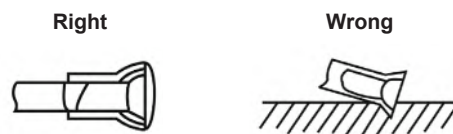

- If piping installation cannot be completed until the following day or longer, solder the ends of the piping to close them and load with oxygen-free nitrogen using an access device such as a Schrader valve to avoid moisture and contamination by extraneous particles.
- Do not use insulation material containing NH₃ as it can damage the copper piping material and may be a source of future leakage.

9.3.2 Insulation

Attach insulation to Multikit branch (field-supplied or package with each one depending on model) using vinyl tape. Also attach insulation to field-supplied piping to prevent capacity decrease due to ambient air conditions and dewing on pipe surface caused by low pressure.

i NOTE

When polyethylene foam is applied, a thickness of 10 mm for the liquid piping and from 15 mm to 20 mm for the gas piping is recommended.

! CAUTION

Perform insulation work after the surface temperature decreases to the room temperature. If not, the insulation material may melt. If the ends of the piping system are open after finishing the installation work, securely attach caps or vinyl bags to the ends of the piping to prevent moisture or dust entering.

9.4 Refrigerant charge amount

Although refrigerant has been charged into this unit, additional refrigerant charge is required according to piping length.

- The additional refrigerant quantity should be determined and charged into the system according to the following procedure.
- Record the additional refrigerant quantity in order to facilitate maintenance and servicing activities.

CAUTION

- *When charging refrigerant, measure the amount precisely. Overloading or underloading of refrigerant may cause compressor problems. If the actual piping length is less than 5 m consult your dealer.*
- **Appropriate refrigerant**
The refrigerant used in each unit is identified on the specification label and manuals of the unit. Hitachi shall not be held liable for any failure, trouble, malfunction or accident caused by units illegally charged with refrigerants other than the specified one.
- **Consequences of charging non-specified refrigerant**
- *It may cause mechanical failure, malfunction and other accidents. It may cause operational failure of protection and safety devices of air conditioners. It may also cause lubrication failure of the sliding part of the compressor due to deterioration of refrigerant oil.*
- *In particular, hydrocarbon refrigerants (such as propane, R441A, R443A, GF-08, etc.) are not allowed, since these are combustible and may cause major accidents such as fire and explosion in case of improper handling.*
- *Once a non-specified refrigerant has been charged, no further servicing (including draining of refrigerant) shall be performed, even in case of malfunction. Improper handling of refrigerant may be a cause of fire and explosion, and servicing in such cases may be considered an illegal act.*
- *End clients and costumers shall be informed that servicing is not approved, and the installer who charged the non-specified refrigerant shall be asked to fix the unit.*

9.4.1 Refrigerant charge before shipment (W_0 (kg))

W_0 is the outdoor unit refrigerant charge before shipment explained before, and it's shown in the following table:

UTOPIA series 2

Model	Refrigerant charge before shipment (W_0 (kg))	Additional refrigerant charge (P) (g/m)	Maximum additional charge (kg)
RAS-3HVNC1	1.9	40	1.2
RAS-4HVR(C/P)2E	3.0	45	2.9
RAS-5HVR(C/P)2E			
RAS-6HVR(C/P)2E			
RAS-4HR(C/P)2E			
RAS-5HR(C/P)2E			
RAS-6HR(C/P)2E	3.2	60	3.9
RAS-4HVN(C/P)2E			
RAS-5HVN(C/P)2E			
RAS-6HVN(C/P)2E			
RAS-4HN(C/P)2E			
RAS-5HN(C/P)2E			
RAS-6HN(C/P)2E			

9.4.2 Calculation method for the additional refrigerant charge

Calculate the additional refrigerant charge amount according to the following steps:

◆ Step 1: Additional refrigerant charge calculation for liquid piping (W_1 (kg))

Outdoor units have been charged with refrigerant for 20 m of actual piping length: In systems with longer actual piping length, an additional refrigerant charge is required.

Use the following formula:

$$W_1 = (L-20) \times P$$

L: Total piping length (m)

P: Additional refrigerant charge (kg/m) (Refer to the "9.4.1 Refrigerant charge before shipment (W_0 (kg))" chapter)

Refrigerant charge amount



Do not exceed the allowed maximum additional charge.

◆ Step 2: Charging work

Charge refrigerant into the system according to the instructions in the Service Manual.

◆ Step 3: Total refrigerant charge of the system (W_{TOT} (kg))

The total refrigerant charge of this system is calculated by the following formula:

$$W_{TOT} = W_0 + W_1$$

System example (W _{TOT}) =		+		=		kg
--------------------------------------	--	---	--	---	--	----

◆ Step 4: Record the refrigerant charge

Fill the “F-Gas Label” with the refrigerant charge quantity in order to facilitate maintenance and servicing activities:

(EN) REFRIGERANT INFORMATION, (ES) INFORMACIÓN SOBRE EL REFRIGERANTE, (FR) INFORMATION SUR LE FLUIDE FRIGORIGÈNE, (DE) KÜHLMITTELINFORMATION, (IT) INFORMAZIONI SUL REFRIGERANTE, (PR) INFORMAÇÕES SOBRE O REFRIGERANTE, (DA) OPLYSNINGER OM KØLEMIDDEL, (NL) INFORMATIE OVER KOELSTOF, (SV) KYLNINGSSINFORMATION, (EL) ΣΤΟΙΧΕΙΑ ΨΥΚΤΙΚΟΥ ΜΕΣΟΥ, (BG) ИНФОРМАЦИЯ ЗА ХЛАДИЛНИЙ АГЕНТ, (CS) INFORMACE O CHLADIVU, (ET) KÜLMAAGENTSI INFORMATSIOON, (HR) INFORMACIJA O RASHLADNOM MEDIJU, (HU) HŰTŐKÖZEG INFORMÁCIÓ, (LT) INFORMACIJA APIE FREONĄ, (LV) INFORMĀCIJA PAR FREONU, (PL) INFORMACJE O CZYNNIKU, (RO) INFORMAȚII AGENT FRIGORIFIC, (RU) Рефигерант-Рефригерант-Флуиде фригоригене-Кühlmittel-Көлемдік-Көелістік-Кылыңгыс-Медзю-Хлазиднен агент-Чиладиво-Күлмайне-Рашладна твар- Hűtőközeg-Érzős- Saldymo agensas- Czynniki chłodniczy- Agent frigorific:

(1) GWP: PCA, PRP, PAG, GSP, VAP [675] t CO₂ = (1) x (2) / 1000

(EN) Factory charge (Refer to nameplate), (ES) Carga de fábrica (consulte placa de características), (FR) Charge en usine (Reportez-vous à l'Étiquette des Spécifications), (DE) Werksbefüllung (Siehe Typenschild), (IT) Quantità già caricata (Fare riferimento alla piastrina delle specifiche), (PR) Carga de fábrica (Fare riferimento alla piastrina delle specifiche), (DA) Påfyldt fra fabrikken (Se specificationsmærket), (NL) Infabriek gevuld (Zie specificatielabel), (SV) Påfyllning från fabriken (Se märkeskennet), (EL) Εργαστηριακή πλήρωση (Ανατρέξτε στην πινακίδα προδιαγραφών), (BG) Заводско зареждане (Съответно пропусковия етикет), (CS) Náplň z výroby (Viz revizní štítek jednotky), (ET) Tehase kogus (Vastavalt Spetsifikatsioonilehel), (HR) Tvorničko punjenje (Obatrite pozornost na specifikacijsku tablicu), (HU) Gyári töltés (Aztartású szett), (LT) Gamylinis kiekis (Žiūrėti angimamo etiketės), (LV) Uzpildīts rūpnīcā (Skatieties specifikāciju etiķetē), (PL) Napełnienie fabryczne (Zgodnie ze specyfikacją na tabliczce), (RO) Încărcatura din fabrică (Referitor la Eticheta cu specificații), (RU) Каргца аггунтвна, (PT) Carga adicional, (DA) Ekstra påfyldning, (NL) Extra vulling, (SV) Tillägare påfyllning, (EL) Προσθετιή πλήρωση, (BG) Допълнително зареждане, (CS) Dodatečná náplň, (ET) Lisakogus, (HR) Dodatno punjenje, (HU) További töltés, (LT) Papildyti, (LV) Papilduzpilde, (PL) Dodatkowe napełnienie, (RO) Încărcatură suplimentară,

(2) (EN) Total Charge, (ES) Carga total, (FR) Charge totale, (DE) Gesamfüllmenge, (IT) Carica totale, (PT) Carga total, (DA) Samlet påfyldning, (NL) Totale vulling, (SV) Total påfyllning, (EL) Συνολική πλήρωση, (BG) Общо зареждане комбинирно, (CS) Celková náplň, (ET) Üldine kogus, (HR) Ukupno punjenje, (HU) Teljes töltés, (LT) Bendras kiekis, (LV) Kopējā uzpilde, (PL) Całkowite napełnienie, (RO) Încărcatură totală.

(EN) REFRIGERANT INFORMATION, (ES) INFORMACIÓN SOBRE EL REFRIGERANTE, (FR) INFORMATION SUR LE FLUIDE FRIGORIGÈNE, (DE) KÜHLMITTELINFORMATION, (IT) INFORMAZIONI SUL REFRIGERANTE, (PR) INFORMAÇÕES SOBRE O REFRIGERANTE, (DA) OPLYSNINGER OM KØLEMIDDEL, (NL) INFORMATIE OVER KOELSTOF, (SV) KYLNINGSSINFORMATION, (EL) ΣΤΟΙΧΕΙΑ ΨΥΚΤΙΚΟΥ ΜΕΣΟΥ, (BG) ИНФОРМАЦИЯ ЗА ХЛАДИЛНИЙ АГЕНТ, (CS) INFORMACE O CHLADIVU, (ET) KÜLMAAGENTSI INFORMATSIOON, (HR) INFORMACIJA O RASHLADNOM MEDIJU, (HU) HŰTŐKÖZEG INFORMÁCIÓ, (LT) INFORMACIJA APIE FREONĄ, (LV) INFORMĀCIJA PAR FREONU, (PL) INFORMACJE O CZYNNIKU, (RO) INFORMAȚII AGENT FRIGORIFIC, (RU) Рефигерант-Рефригерант-Флуиде фригоригене-Кühlmittel-Көлемдік-Көелістік-Кылыңгыс-Медзю-Хлазиднен агент-Чиладиво-Күлмайне-Рашладна твар- Hűtőközeg-Érzős- Saldymo agensas- Czynniki chłodniczy- Agent frigorific:

(1) GWP: PCA, PRP, PAG, GSP, VAP [2088] t CO₂ = (1) x (2) / 1000

(EN) Factory charge (Refer to nameplate), (ES) Carga de fábrica (consulte placa de características), (FR) Charge en usine (Reportez-vous à l'Étiquette des Spécifications), (DE) Werksbefüllung (Siehe Typenschild), (IT) Quantità già caricata (Fare riferimento alla piastrina delle specifiche), (PR) Carga de fábrica (Fare riferimento alla piastrina delle specifiche), (DA) Påfyldt fra fabrikken (Se specificationsmærket), (NL) Infabriek gevuld (Zie specificatielabel), (SV) Påfyllning från fabriken (Se märkeskennet), (EL) Εργαστηριακή πλήρωση (Ανατρέξτε στην πινακίδα προδιαγραφών), (BG) Заводско зареждане (Съответно пропусковия етикет), (CS) Náplň z výroby (Viz revizní štítek jednotky), (ET) Tehase kogus (Vastavalt Spetsifikatsioonilehel), (HR) Tvorničko punjenje (Obatrite pozornost na specifikacijsku tablicu), (HU) Gyári töltés (Aztartású szett), (LT) Gamylinis kiekis (Žiūrėti angimamo etiketės), (LV) Uzpildīts rūpnīcā (Skatieties specifikāciju etiķetē), (PL) Napełnienie fabryczne (Zgodnie ze specyfikacją na tabliczce), (RO) Încărcatura din fabrică (Referitor la Eticheta cu specificații), (RU) Каргца аггунтвна, (PT) Carga adicional, (DA) Ekstra påfyldning, (NL) Extra vulling, (SV) Tillägare påfyllning, (EL) Προσθετιή πλήρωση, (BG) Допълнително зареждане, (CS) Dodatečná náplň, (ET) Lisakogus, (HR) Dodatno punjenje, (HU) További töltés, (LT) Papildyti, (LV) Papilduzpilde, (PL) Dodatkowe napełnienie, (RO) Încărcatură suplimentară,

(2) (EN) Total Charge, (ES) Carga total, (FR) Charge totale, (DE) Gesamfüllmenge, (IT) Carica totale, (PT) Carga total, (DA) Samlet påfyldning, (NL) Totale vulling, (SV) Total påfyllning, (EL) Συνολική πλήρωση, (BG) Общо зареждане комбинирно, (CS) Celková náplň, (ET) Üldine kogus, (HR) Ukupno punjenje, (HU) Teljes töltés, (LT) Bendras kiekis, (LV) Kopējā uzpilde, (PL) Całkowite napełnienie, (RO) Încărcatură totală.

- ① Factory Charge
- ② Additional Charge
- ③ Total Charge
- ④ t CO₂

9.5 Caution in case of refrigerant leakage

DANGER

- *Fitters and the designers of the installations must strictly observe local and national legislation, and local codes regarding safety requirements in the event of refrigerant leaks.*
- *The following standards may be applicable, if local regulations are not available. International Organization for Standardization, ISO5149 or European Standard, EN378 for R410A refrigerant gas.*
- *The following standards may be applicable, if local regulations are not available. International Organization for Standardization, ISO 817 and International Electrotechnical Commission, IEC 60335-2-40:2018 and European Standard, EN 378-1:2016 for R32 refrigerant gas.*

9.5.1 Maximum permitted concentration of hydrofluorocarbon (HFC)

R410A Refrigerant circuit

The R410A refrigerant gas, used in the equipment, is fireproof and non-toxic.

The maximum permissible concentration of HFC R410A gas in the air is 0.44 kg/m³, according to Standard EN378-1. Consequently, effective measures must be adopted to maintain the concentration of R410A gas in the air below 0.44 kg/m³ in case of leakage.

DANGER

In the event of a leak, the gas will spread around the room, displacing the air, and could therefore result in asphyxia.

NOTE

Before the indoor unit installation, confirm that the room can keep the lower gas concentration than the limit value in order to take the emergency countermeasures even if the gas leakage is occurred.

R32 Refrigerant circuit

The unit installation and refrigerant piping should comply with the relevant local and national regulations for the designed refrigerant.

Due to R32 refrigerant and depending on final refrigerant charge amount, a minimum floor area for installation must be considered.

- If total refrigerant charge amount <1.84kg, there are no additional minimum floor area requirements.
- If total refrigerant charge amount ≥1.84kg, there are additional minimum floor area requirements to be checked.

NOTE

In case of not achieving the minimum floor area, contact with your dealer.

9.5.2 Calculation of refrigerant concentration

R410A Refrigerant circuit

- 1 Calculate the total quantity of refrigerant R (kg) charged in the system. To do so, connect all the indoor units of the rooms in which you wish to have air conditioning.
- 2 Calculate the volume V (m³) of each room.
- 3 Calculate the refrigerant concentration C (kg/m³) of the room in accordance with the following formula:

$$C = R / V$$

R : Total quantity of refrigerant charged (kg).

V : Room volume (m³).

C : Refrigerant concentration (≤ 0.44 kg/m³ for R410A gas).

R32 Refrigerant circuit

- The following chart and table shows the minimum floor area (A_{\min}) required for the installation of an indoor unit from a refrigerant system containing a certain refrigerant charge (m_c) of R32 (A2L refrigerant), and supposing a total room height not lower than 2.2 m. (According to IEC 60335-2-40:2018 and EN 378-1:2016).
- For $m_c < 1.84$ kg, IEC 60335-2-40:2018 and EN 378-1:2016 do not establish any minimum floor area restriction. In that case check local regulations to ensure that no hard restrictions may apply.

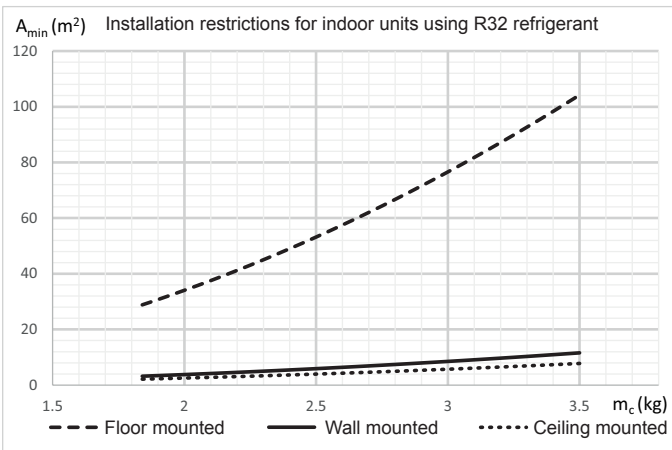

$$A_{min} = (m_c * / (2.5 * LFL^{(5/4)} * h_0)^2$$

- A_{min} : Minimum installation area of an Indoor unit for a given refrigerant charge m_c (kg) and considering the installation height h_0 (m²)
- h_0 : Installation height of the bottom side of the indoor unit + distance from the indoor unit bottom side to the lowest part for which a refrigerant leak may release to the indoor area
- m_c : total system refrigerant charge that could be released to the indoor area in case of undetected refrigerant leak.
- LFL: Lower Flammability Limit for R32, 0,307 kg/m³ as established by EN 378-1:2016 and ISO 817

Minimum floor area for equipment installed inside			
m_c (kg)	A_{min} (m ²)	A_{min} (m ²)	A_{min} (m ²)
	Floor mounted	Wall mounted	Ceiling mounted
1.84	28.81	3.20	2.14
1.9	30.72	3.41	2.29
2.0	34.04	3.78	2.53
2.1	37.53	4.17	2.79
2.2	41.19	4.58	3.06
2.3	45.02	5.00	3.35
2.4	49.02	5.45	3.65
2.5	53.19	5.91	3.96
2.6	57.53	6.39	4.28
2.7	62.04	6.89	4.61
2.8	66.72	7.41	4.96
2.9	71.58	7.95	5.32
3.0	76.6	8.51	5.70
3.1	81.79	9.09	6.08
3.2	87.15	9.68	6.48
3.3	92.68	10.30	6.89
3.4	98.39	10.93	7.32
3.5	104.26	11.58	7.75
4.0	136.17	15.13	10.13
4.5	172.34	19.15	12.82
5.0	212.77	23.64	15.83
6.0	306.39	34.04	22.79
7.0	417.03	46.34	31.02
8.0	544.69	60.52	40.51
9.0	689.38	76.60	51.28
10.0	851.08	94.56	63.30

- Floor mounted: Refrigerant parts not sealed installed <0.6m height
- Wall mounted: Refrigerant parts not sealed installed >1.8m height
- Ceiling mounted: Refrigerant parts not sealed installed >2.2m height

9.5.3 Countermeasure for R410A refrigerant leakage

The room should have the following characteristics in case of a leak of refrigerant:

- 1 Opening without shutter to permit the circulation of fresh air in the room.
- 2 Opening without door measuring 0.15%, or greater, of the floor surface.
- 3 There must be a ventilator fan connected to a gas leak detector, with a ventilator capacity of 0.92 m³/min or greater.

⚠ DANGER

Special attention should be given to areas where the refrigerant may be deposited and stay in the room, such as basements or similar, as it is heavier than air.

10 . Electrical wiring

Index

10.1	General information.....	98
10.1.1	Electromagnetic compatibility.....	98
10.1.2	Harmonics	99
10.2	General verifications.....	99
10.3	DIP and RSW switches settings.....	99
10.3.1	RAS-3HVRC2.....	99
10.3.2	RAS-(4-6)H(V)(R/N)(P/C)2E	102
10.4	System wiring diagram.....	105
10.4.1	Outdoor and indoor unit electrical wiring.....	105
10.4.2	Wire size.....	106
10.5	H-LINK II system	107
10.5.1	Features	107
10.5.2	Specifications	107
10.5.3	DIP Switch setting for 2, 3 and 4 indoor units systems	108
10.5.4	Examples of the system of connection between H-LINK and H-LINK II units	110
10.5.5	Examples of H-LINK II system	111
10.6	System Control - Main concept	113
10.6.1	UTOPIA Prime	113
10.6.2	UTOPIA IVX Prime	114
10.6.3	System control comparison	115

10.1 General information

DANGER

- Do not connect or adjust any wiring or connections unless the main power switch is OFF. Check and test to ensure that if there is more than one source of power supply, all are turned OFF.
- Use an earth leakage breaker with medium sensitivity, and an activation speed of 0.1 sec or less. If this is not fitted, there is a risk of electric shock and/or fire.
- Install an earth leakage breaker, fuse or circuit breaker of the specific capacity for each outdoor unit power line. Not fitting it may cause an electric shock or fire.
- Check that the earth wire is securely connected, tagged and locked in accordance with national and local codes.
- Never connect the earth cable to the refrigerant pipes. The gas in the pipes could cause a fire.
- Do not connect the earth cable to the lighting arrest system. The electrical potential of earth would increase abnormally.

CAUTION

- Before any work to the electrical wiring or regular inspections, switch off the mains power supply of the indoor and outdoor units. Wait three minutes before starting installation or maintenance work.
- Make sure that the interior and exterior fans have come to a complete standstill before starting work on the electrical wiring or regular inspections.
- Protect cables, the drainage pipe, electrical components, etc. from rodents and insects; otherwise these might damage unprotected components and this could result in fire.
- Do not allow cables to come into contact with the refrigerant pipes, metal edges, printed circuit boards (PCB) or the electric components inside the unit; the cables may be damaged and this could result in fire.
- Firmly secure the cables inside the indoor unit with plastic flanges.
- Connecting the operating line cables incorrectly may lead to faults in the PCB.
- Secure the cable of the remote control switch with the cord clamp inside the electrical box.
- Before starting work on the installation of the outdoor unit, set the DSW required to supply voltage in the correct position.

NOTE

- Fix the rubber bushes with adhesive when the outdoor unit ducts are not used.
- Use shielded twisted pair cable (more than 0.75 mm²) for operation wiring between outdoor unit and indoor unit, and operation wiring between indoor unit and indoor unit. (Do not use wire with more than 3 cores).
- H-LINK twist pair shielded cable must be grounded in the outdoor unit side.
- Use shielded wires for intermediate wiring to protect the units from noise obstacle at length of less than 300 m and size complied with local code.

10.1.1 Electromagnetic compatibility

Following the Council Directive 2004/108/EC (89/336/EEC), relating to electromagnetic compatibility, next table indicates: Maximum permissible system impedance Z_{max} at the interface point of the user's supply, in accordance with EN61000-3-11.

MODEL	Z_{max} (Ω)	MODEL	Z_{max} (Ω)
RAS-3HVRC2	0.43	RAS-4HRC2E	-
RAS-4HVRC2E	0.30	RAS-5HRC2E	-
RAS-5HVRC2E	0.30	RAS-6HRC2E	-
RAS-6HVRC2E	0.30	RAS-4HNC2E	-
RAS-4HVNC2E	0.30	RAS-5HNC2E	-
RAS-5HVNC2E	0.30	RAS-6HNC2E	-
RAS-6HVNC2E	0.30	RAS-4HRP2E	-
RAS-4HVRP2E	0.30	RAS-5HRP2E	-
RAS-5HVRP2E	0.30	RAS-6HRP2E	-
RAS-6HVRP2E	0.30	RAS-4HNP2E	-
RAS-4HVNP2E	0.30	RAS-5HNP2E	-
RAS-5HVNP2E	0.30	RAS-6HNP2E	-
RAS-6HVNP2E	0.30		

10.1.2 Harmonics

Harmonics situation of each model regarding EN 61000-3-2 and EN 61000-3-12 is as follows:

MODELS SITUATION REGARDING EN 61000-3-2 and EN 61000-3-12 S _{sc} "xx"	MODEL	S _{sc} "xx" (KVA)
Equipment complying with EN 61000-3-2 (professional use)	RAS-3HVRC2	-
	RAS-(4-6)H(R/N)(C/P)2E	633
Equipment complying with EN 61000-3-12	RAS-(4-6)HV(R/N)(C/P)2E	-

10.2 General verifications

- 1 Make sure the electric components supplied by the installer (main power switches, circuit breakers, wires, connectors and connection terminals) have been selected correctly in line with the electrical data given.
 - a. The electricity supply to the unit should be via an exclusive power control switch and protective circuit breaker, certified and installed in accordance with local or national safety regulations.
 - b. The electricity supply for the outdoor and indoor units should be separate. Connect the voltage supply wiring for each group of indoor units to the same outdoor unit.
- 2 Check that the supply voltage is between 90 and 110% of the rated voltage. Where the voltage capacity is too low, it will not be possible to start the system due to the drop in voltage.
- 3 Sometimes, the refrigeration/heating system is not able to operate correctly in the following cases:
 - When the system is supplied from the same supply line as other major consumers (heavy machinery, power inverter systems, cranes, welding machinery, etc).
 - When the supply cables of the major consumers and the refrigeration/heating system are very close together.

In these cases, induction in the wiring to the refrigeration/heating system may arise due to a rapid change in the electricity consumption of the above consumers and their start-up. Therefore before starting installation work, check the regulations and standards concerning adequate protection of the power supply line.

NOTE

For further information, please refer to the applicable legislation in the country in which the unit is to be fitted.

- 4 During the preliminary preparation work of the electricity supply line for the unit, the provisions in local and national legislation must never be violated.
- 5 Check that the earth cable is correctly connected.

10.3 DIP and RSW switches settings

TURN OFF all power source before setting. Without turning OFF, the switches do not work and the contents of the setting are invalid.

Mark of "■" indicates the position of dip switches. Set the dip switches according to the following figures.

10.3.1 RAS-3HVRC2

◆ Quantity and Position of DIP Switches

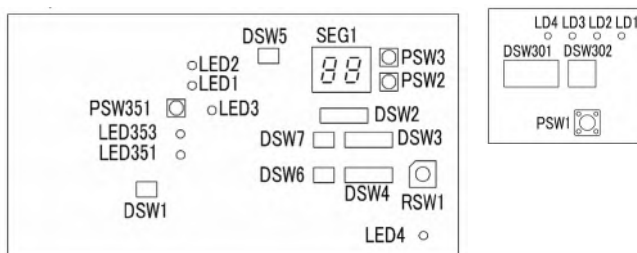

CAUTION

Before changing the settings of the DSWs, the voltage supply should be disconnected. Otherwise, the new settings will not be valid.

◆ **DSW301: Test run mode**

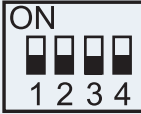
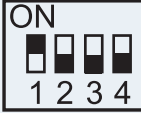
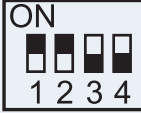
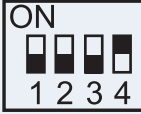
Setting before shipment	
Cooling	
Heating	
Forced stop of compressor	





◆ **DSW302: Piping Length Setting (Setting is required)**

Setting before shipment	
Pipe length (<5m)	
Pipe length (≥30m)	

◆ **DSW1: For test run**

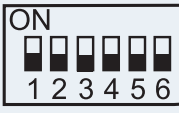
When set pin number 1 to ON, the electric current detection is cancelled. Pin number 1 should be set back to OFF after electrical work.	
---	---

◆ **DSW2: Optional function setting**

Factory setting	
Optional function setting	
External input / output setting mode	
Annual cooling	

◆ **DSW3: Capacity Setting (No setting is required)**

Factory setting	
-----------------	--

◆ **DSW4 / RSW1: Refrigerant cycle number setting (Setting is required)**

Setting for the tens digit	
Setting position Set by inserting slotted screwdriver into the groove (setting for the last digit)	

◆ **DSW5: Transmission setting of end terminal resistance**

Factory setting	
Cancellation	

In the case that the outdoor units quantity in the same H-LINK is 2 or more, set No. 1 pin of DSW5 at “OFF” side from the 2nd refrigerant group outdoor unit. If only one outdoor unit is used, no setting is required.

Setting for transmission

It is required to set the outdoor unit number refrigerant cycle and end terminal resistance for the H-LINK.

In the same refrigerant cycle, set the same refrigerant cycle number for the outdoor unit and the indoor units.

Example incase of setting before cycle number 25

DSW4: Turn ON pin number 2	
RSW1: set dial number 5	

Turn OFF DSW5 number 1 pin for cancel of end terminal resistance setting

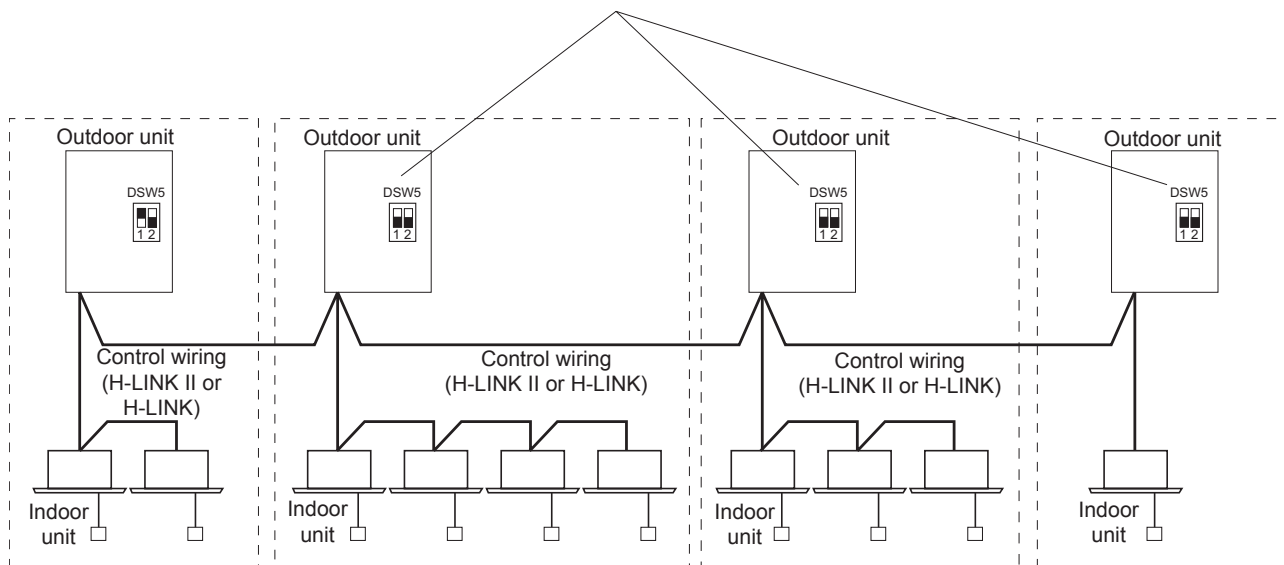

◆ **DSW6: No setting is required (do not change)**

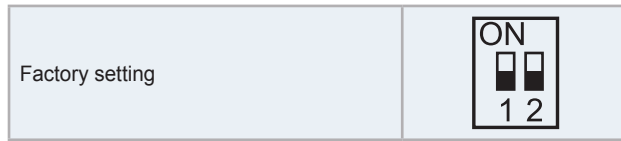

◆ **DSW7: No setting is required (do not change)**

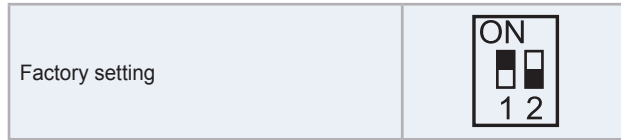

10.3.2 RAS-(4-6)H(V)(R/N)(P/C)2E

◆ **Quantity and Position of DIP Switches**

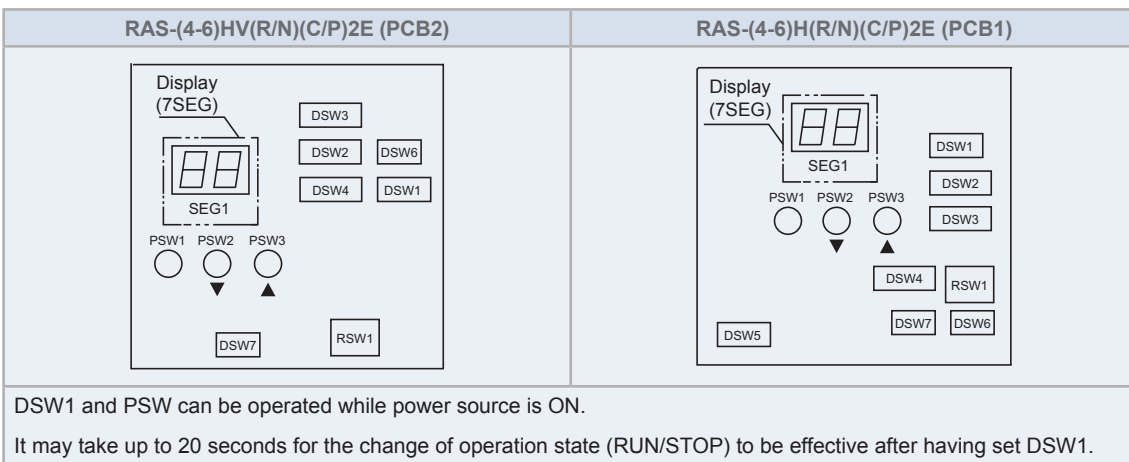

⚠ CAUTION

Before changing the settings of the DSWs, the voltage supply should be disconnected. Otherwise, the new settings will not be valid.

◆ **DSW1: For test run**

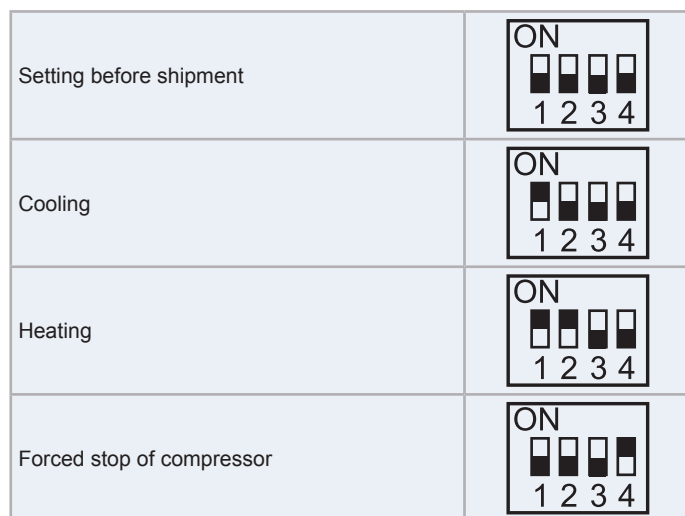

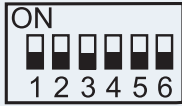
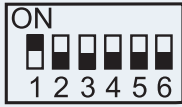
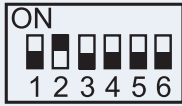
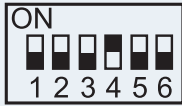
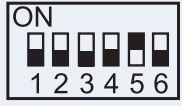
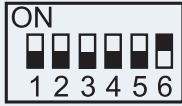

◆ **DSW2: Optional function setting**

Pipe length setting should be performed as follows according to the on-site pipe length.	Setting before shipment	ON 
	Pipe length (≤5m)	ON 
	Pipe length (≥30m)	ON 
Control to support existing pipes or when using Ø19,05 gas pipe (soft-annealed), switch ON DSW2 pin 4 in the outdoor unit PCB	ON 	
Optional function setting mode (The optional function selection mode becomes available)	ON 	
External input/output setting mode (The input / output signals selection mode becomes available).	ON 	

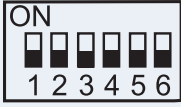

◆ **DSW3: Capacity Setting (No setting is required)**

Factory setting	RAS-4HV(R/N)(C/P)2E	RAS-5HV(R/N)(C/P)2E	RAS-6HV(R/N)(C/P)2E
	RAS-4H(R/H)(C/P)2E	RAS-5H(R/N)(C/P)2E	RAS-6H(R/N)(C/P)2E

◆ **DSW4 / RSW1: Refrigerant cycle number setting (Setting is required)**

Setting for the tens digit	ON 
Setting position Set by inserting slotted screwdriver into the groove (setting for the last digit)	

◆ **DSW5: Transmission setting of end terminal resistance**

Factory setting	
Cancellation	



In the case that the outdoor units quantity in the same H-LINK is 2 or more, set No. 1 pin of DSW5 at “OFF” side from the 2nd refrigerant group outdoor unit. If only one outdoor unit is used, no setting is required.

Setting for transmission

It is required to set the outdoor unit number refrigerant cycle and end terminal resistance for the H-LINK.

In the same refrigerant cycle, set the same refrigerant cycle number for the outdoor unit and the indoor units.

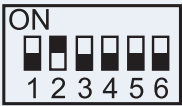
Example incase of setting before cycle number 25

DSW4: Turn ON pin number 2	
RSW1: set dial number 5	

Turn OFF DSW5 number 1 pin for cancel of end terminal resistance setting

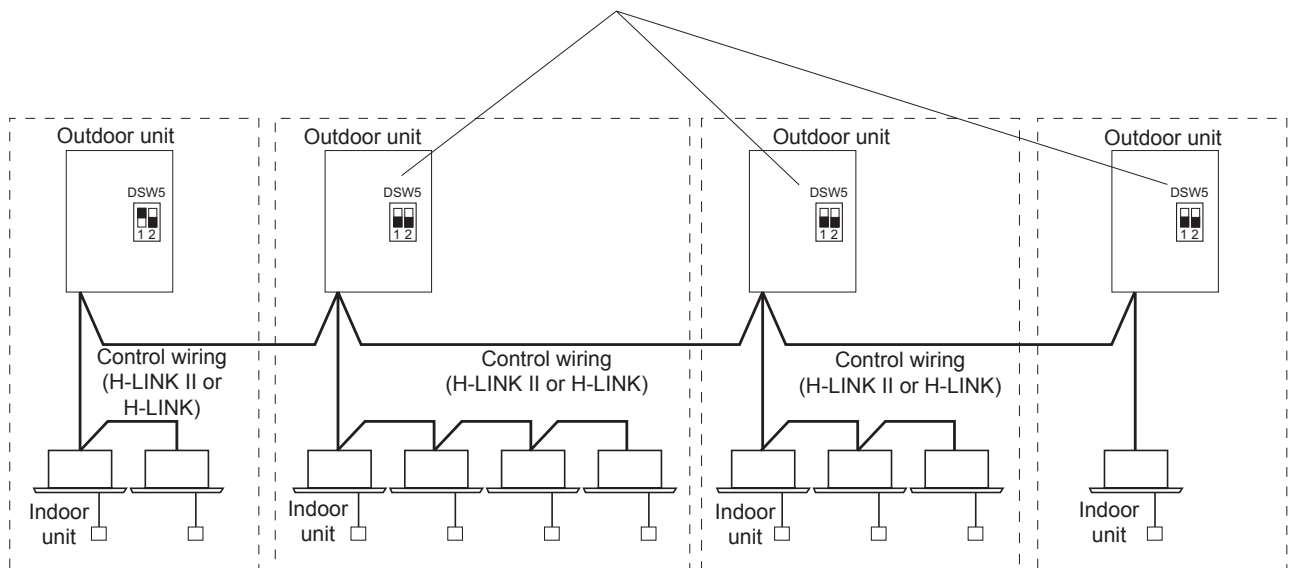

◆ **DSW6: No setting is required (do not change)**

	RAS-(4-6)H(V)(R/N)C2E	RAS-(4-6)H(V)(R/N)P2E
Factory setting		

◆ **DSW7: No setting is required (do not change)**

	RAS-(4-6)H(V)(R/N)C2E	RAS-(4-6)H(V)(R/N)P2E
Factory setting		

10.4 System wiring diagram

10.4.1 Outdoor and indoor unit electrical wiring

- Connect the electrical wires between the indoor unit and the outdoor unit as show in the figure.
- When installing the electrical wiring, follow local codes and regulations.
- The refrigerant piping and the control wiring are connected to the units in the same refrigerant cycle.
- Use shielded twisted pair cable (more than 0.75 mm²) for operation wiring between the outdoor unit and indoor unit, and operation wiring between indoor unit and indoor unit.
- Use a 2-core wire for the operating line (do not use wire with more than 3 cores).
- Use shielded wires for intermediate wiring to protect the units from noise interference at lengths of less than 300 m. The size must comply with local code.
- Open a hole near the connection hole of power source wiring when multiple outdoor units are connected from a single power source line.
- The recommended breaker sizes are detailed in the “10.4.2 Wire size” section.
- In the case that a conduit tube for field-wiring is not used, fix rubber bushes with adhesive on the panel.
- All field wiring and equipment must comply with local and international codes.
- H-LINK twist pair shielded cable must be grounded in the outdoor unit side.

i NOTE

Take care with the connection of the operating line. Incorrect connection may cause a failure of the PCB.

Power source from the outdoor unit to the indoor unit

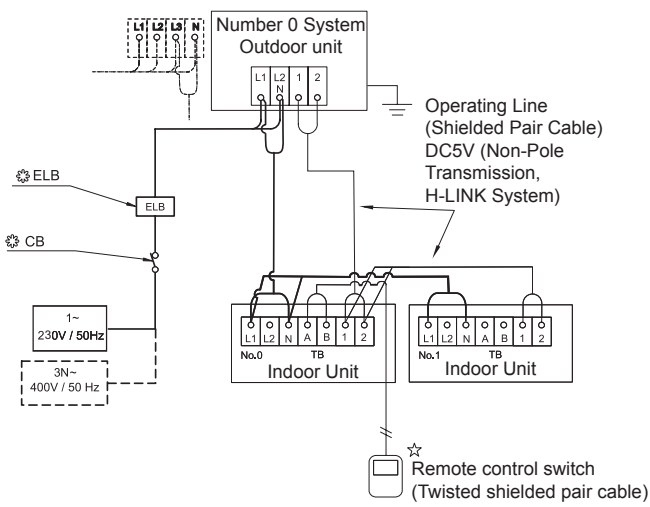

Independent power source of outdoor unit and indoor unit

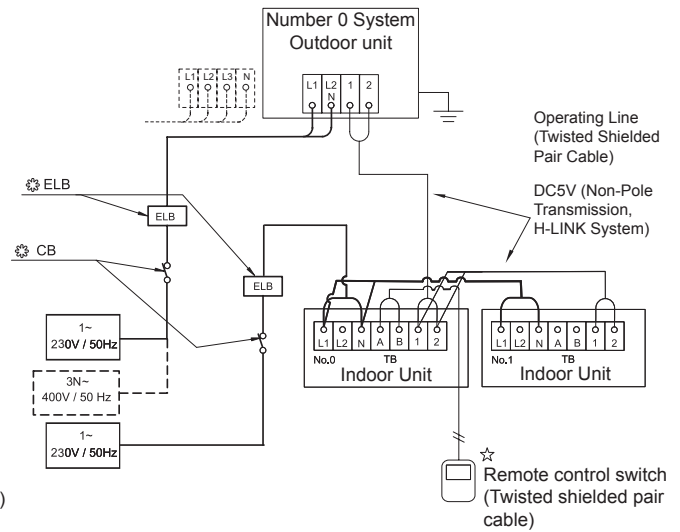

- TB Terminal board
- CB Circuit Breaker (field supplied)
- ELB Earthleakage Breaker (field supplied)
- A Power source from the outdoor unit to the indoor unit
- Field Wiring
- ⊗ Field supplied
- ☆ Optional Accessory

10.4.2 Wire size

Recommended minimum sizes for field provided wires:

Use wires which are not lighter than the ordinary polychloroprene sheathed flexible cord (code designation 60245 IEC 57).

Model	Power supply	Power source cable size	Transmitting cable size
		EN60 335-1	EN60 335-1
All Indoor Units (except 8, 10, 16 and 20HP)	1~ 230V 50Hz or 1~ 220-240V 50Hz (depending on the model)	0.75 mm ²	0.75 mm ²
RAS-3HVRC2	1~ 230V 50Hz	4.0 mm ²	
RAS-(4-6)HV(R/N)(C/P)2E		6.0 mm ²	
RAS-(4-6)H(R/N)(C/P)2E	3N~ 400V 50Hz	4.0 mm ²	

i NOTE

Follow local codes and regulations when selecting field wires, Circuit breakers and Earth Leakage breakers.

10.5 H-LINK II system

The H-LINK II is the wiring connection system between units.

The H-LINK II wiring system only needs:

- Two transmission wires connecting each indoor and outdoor unit for a total of 64 refrigerant cycles.
- Connection wiring for all indoor and outdoor units in series.

CAUTION

The H-LINK II system cannot be applied to the models with the old cycle, nor to units with an old transmission.

10.5.1 Features

- The total wiring length is considerably reduced compared to traditional connections.
- Only one connection is required for the wiring between the indoor and outdoor units.
- The wiring connection of the complementary central control devices is easy.

NOTE

CSNET WEB / CSNET Manager is centralized control system which allows the installation to be controlled remotely. It can be connected at any point of the local corporate network, or even via the Internet.

10.5.2 Specifications

A: outdoor unit.

B: indoor unit.

C: refrigerant cycle.

D: transmission cables.

E: refrigerant piping.

- Transmission cable: 2-wire.
- Polarity of transmission cable: non-polar wire.
- The maximum number of units that can be connected is 64 outdoor units and 160 indoor units (including UTOPIA and/or SET FREE models) per H-LINKII system.
- Maximum wiring length: total 1000 m (including CSNET Manager 2).
- It is possible to increase the maximum wiring length up to 5000 m by using up to four PSC-5HR units.
- Recommended cable: shielded twisted pair cable, over 0.75 mm² (Equivalent to KPEV-S).
- Voltage: 5 V DC.

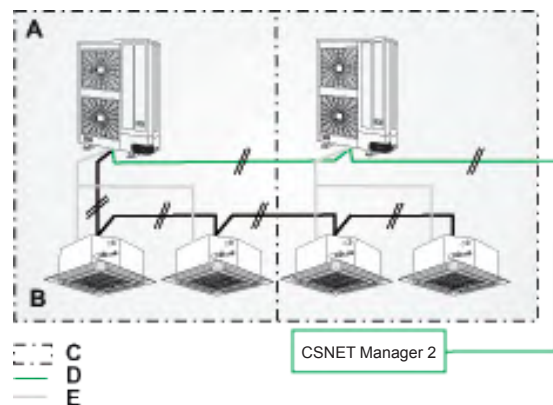

CAUTION

For the H-LINK II system must use twisted shielded pair cable or shielded pair cable.

10.5.3 DIP Switch setting for 2, 3 and 4 indoor units systems

Dip switch of indoor and outdoor unit PCB - H-LINK II

The DIP switches of all the indoor and outdoor units have to be set and the impedance of the transmission circuit adapted.

- Example of the setting of the DIP switches.

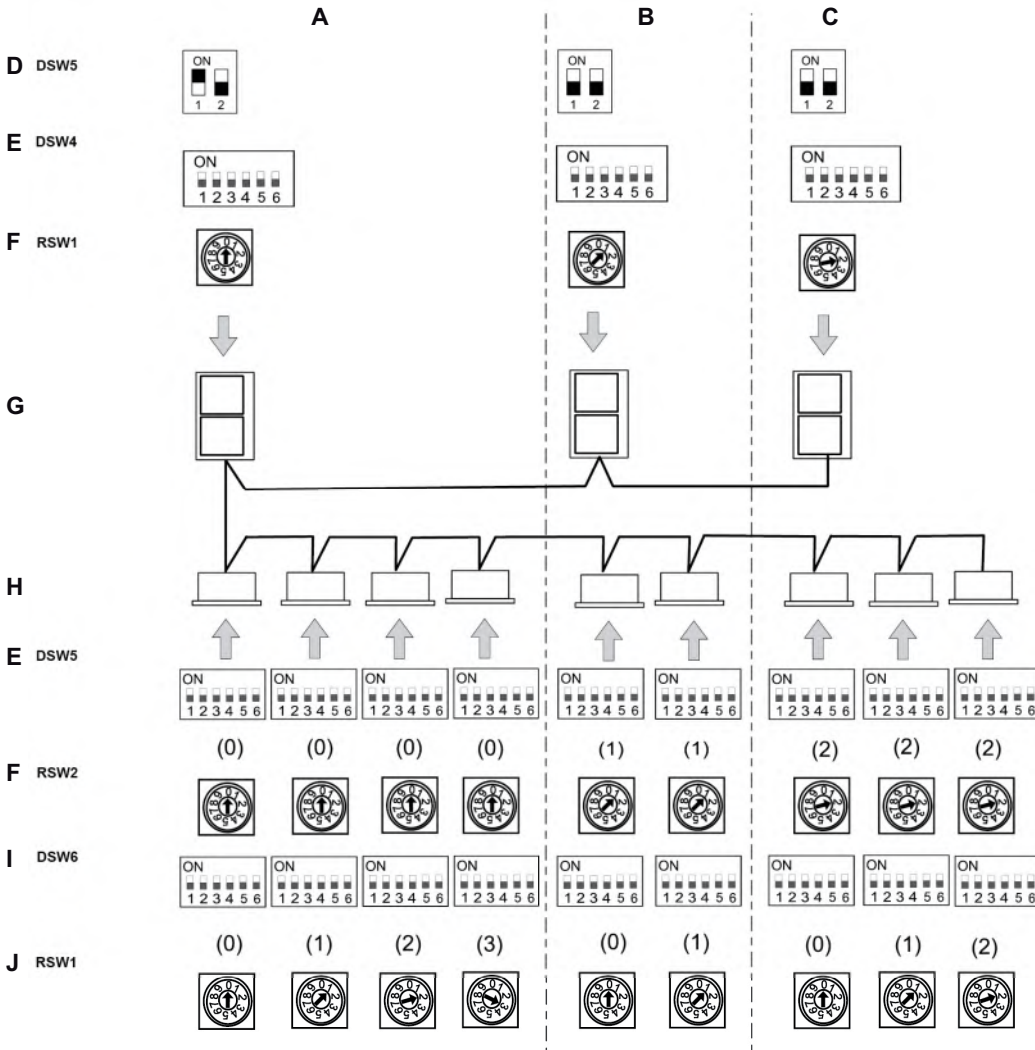

A: Cycle number 0.

B: Cycle number 1.

C: Cycle number 2.

D: Terminal resistance.

E: Number of refrigerant cycle (setting for the tens digit).





F: Number of refrigerant cycle (setting for the last digit).

G: Outdoor units.

H: Indoor units.

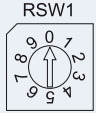
I: Address of the indoor unit (setting for the tens digit).

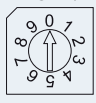
J: Address of the indoor unit (setting for the last digit).

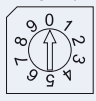
Unit	Name of DIP switch	Ref.	Setting before the Shipment	Function
Outdoor Unit	Refrigerant cycle	DSW4 RSW1	 	For setting the refrigerant cycle address of the outdoor unit. Set the DSW4 and RSW1 to overlap the setting of other outdoor units in the same H-LINK system.
	Resistance of terminal	DSW5		To adapt the impedance of the transmission circuit, adjust DSW5 according to the number of outdoor units of the H-LINK system.
Indoor Unit	Refrigerant cycle	DSW5 RSW1/2	 	For setting the refrigerant cycle address of the indoor unit. Set the DSW5 and RSW2 corresponding to the address of outdoor unit in the same refrigerant cycle.
	Address of the indoor unit	DSW6 RSW1/2	 	Setting indoor unit address. Set the DSW6 and RSW1 not to overlap the setting of other indoor units in the same refrigerant cycle. (If no set, the automatic address function is performed.)

Name of DIP switch	DIP switch and rotary switch (Factory setting)	Indoor unit model
Refrigerant cycle	DSW5 - RWS1	RPK-(0.4-4.0)FSR(H)M RCD-(0.8-6.0)FSR RCI-(1.0-6.0)FSR RPC-(1.5-6.0)FSR RCIM-(0.4-2.5)FSRE RPI-(0.4-6.0)FSRE
	DSW5 - RWS2	RPF(I)-(1.0-2.5)FSN2E RPI-(4.0-6.0)FSN6E-EF RPI-(8.0-10.0)FSRE (-f) RPI-(16.0/20.0)FSN3PE(-f)
Address of the indoor unit	DSW6 - RWS1	RPF(I)-(1.0-2.5)FSN2E RPI-(8.0-10.0)FSN3E(-f) RPI-(16.0/20.0)FSN3PE(-f)
	DSW6 - RWS2	RPK-(0.4-4.0)FSR(H)M RCD-(0.8-6.0)FSR RCI-(1.0-6.0)FSR RPC-(1.5-6.0)FSR RCIM-(0.4-2.5)FSRE RPI-(0.4-6.0)FSRE RPI-(4.0-6.0)FSN6E-EF

10.5.4 Examples of the system of connection between H-LINK and H-LINK II units

In the case of mixed systems with H-LINK and H-LINK II, set the H-LINK units in the first 16 position of the system, as in the following example where 42 systems are connected, 16 with indoor FSN1E units and 26 with indoor FSN4E units.

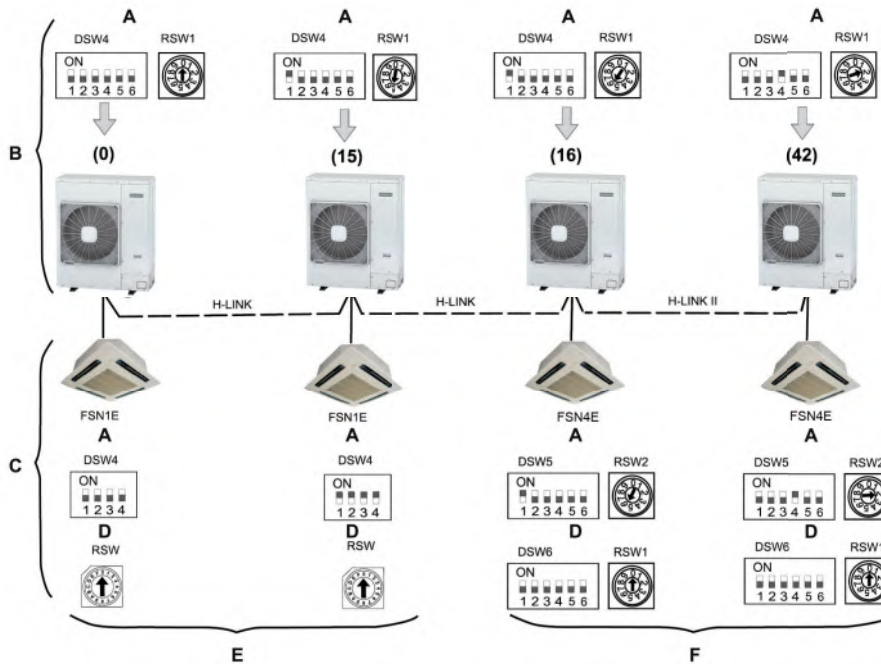

A: Refrigerant cycle.

B: Outdoor unit.

C: Indoor unit.

D: Indoor unit address.

E: Either the current remote control switch (H-LINK) or the new one (H-LINK II) can be used.

F: Only the new remote control switch (H-LINK II) can be used.

i NOTE

- The maximum number of indoor units than an H-LINK II can control is 160.
- If you use PSC-5S and the CSNET WEB 2.0 (systems only compatible with H-LINK) bear in mind that it will only recognize 16 indoor and 16 outdoor units.

10.5.5 Examples of H-LINK II system

Two cases:

1. Using H-LINK II system for air conditioning systems without a central control device (Neither Centralised remote controls nor Building air controls)

- Line connection with all units

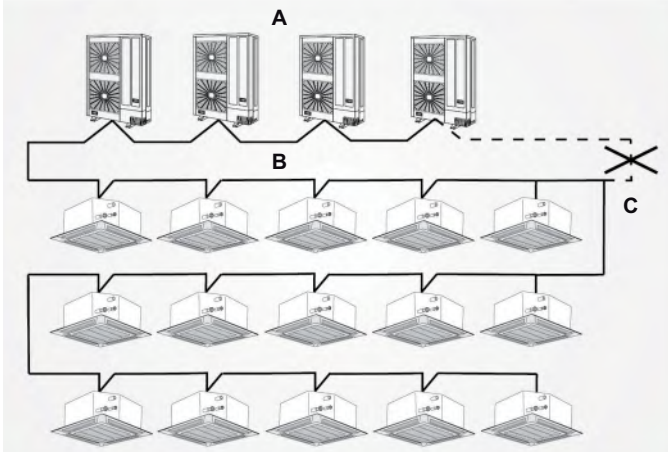

- A: Outdoor units.
- B: Indoor units.
- C: Do not install wiring in a loop.

- Line connection for each floor.

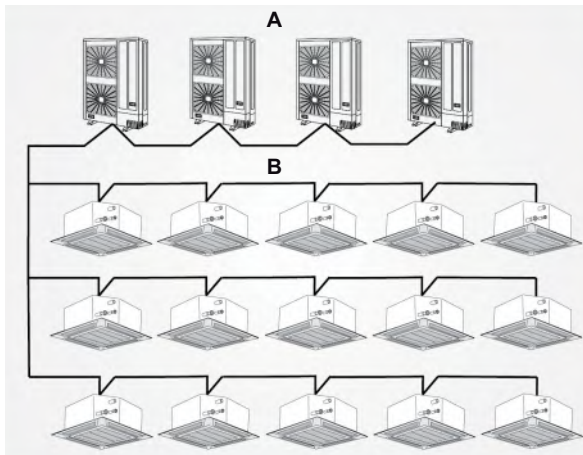

- A: Outdoor units.
- B: Indoor units.

- Connection with one main line and with the branch lines for the units.

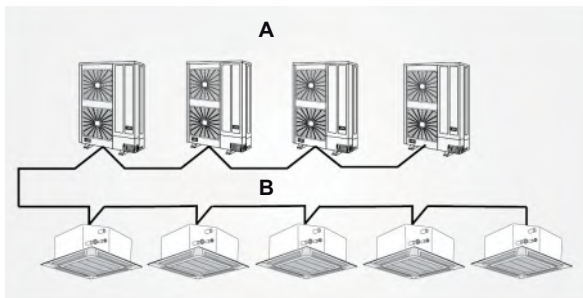

- A: Outdoor units.
- B: Indoor units.

⚠ CAUTION

- The maximum number of units that can be connected is 64 outdoor units and 160 indoor units (including UTOPIA and/or SET FREE, SET FREE Mini).
- Do not install the wiring in a loop.
- If the H-LINK II system is not used when carrying out the electrical wiring as shown above, it must be used once the wiring of the instrument is completed. The DIP switches must therefore be set as specified in the DIP switches on the PCB.

2. Using the H-LINK II system for air conditioning systems with a central control device (Either Centralised remote controls or Building air conditioning control)

- If the central control device is used when carrying out electrical wiring, it can be connected at any point of the H-LINK II wiring.

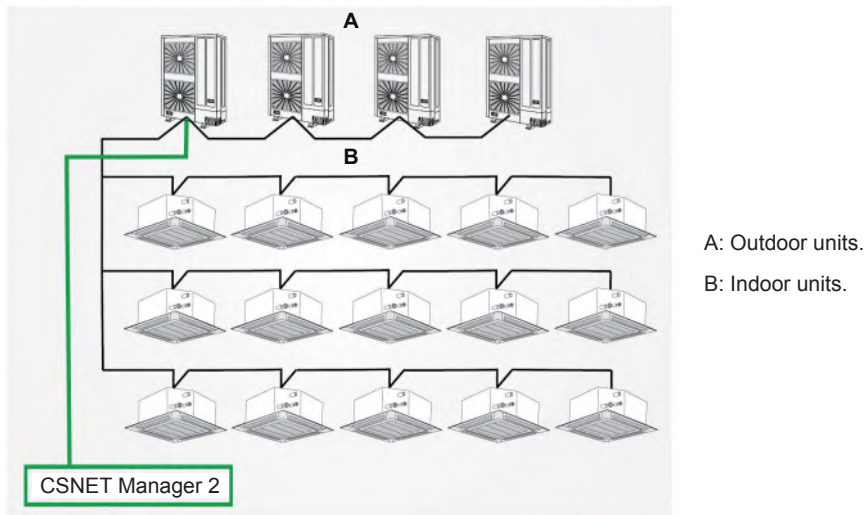

- If the central control device is not used when electrical wiring is carried out, you must connect the H-LINK II wiring to all the systems. The easiest method is usually to connect the outdoor units.

10.6 System Control - Main concept

10.6.1 UTOPIA Prime

When the UTOPIA Prime system is in Thermo-ON, the system will switch to Thermo-OFF as soon as there is an indoor unit that has no demand. The system will return to Thermo-ON when all units are in demand.

◆ Simultaneous operation (only available with UTOPIA Prime)

In the simultaneous operation mode, all indoor units are sharing both operation parameters (Tset, operation mode, fan speed, etc.) and also Thermo-ON/OFF status. All units operate simultaneously as if they were a single indoor unit. All indoor units will go to Thermo-ON status if all of them have load demand, all units will go to Thermo-OFF one of the units has no load demand (has reached Tset).

This unit can be operated simultaneously with 2, 3 and 4 indoor units combinations.

Only one remote control switch (PC-ARFP1E or later models) can be installed.

The remote control switch can control without transmission wiring up to 4 units (FSN4 series or higher) simultaneously.

All optional functions set in the remote controller switch are apply with the same setting to all indoor units.

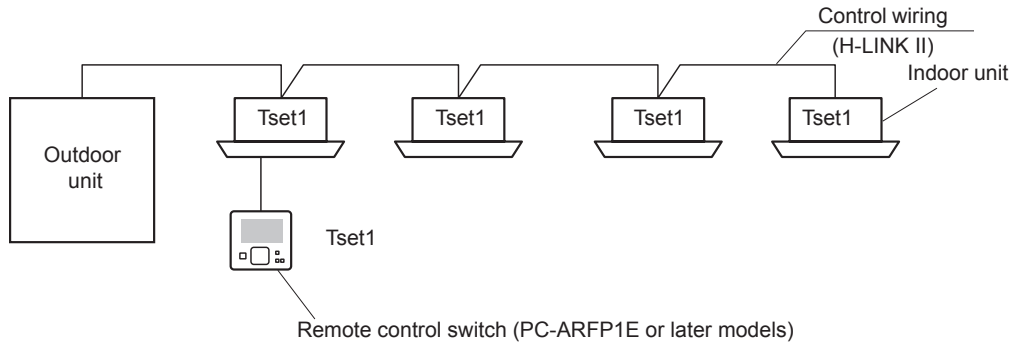

In case indoor units need to have different optional function settings, but with the same setting temperature, then it will have to be wired the operating cable for remote control (transmission wiring).

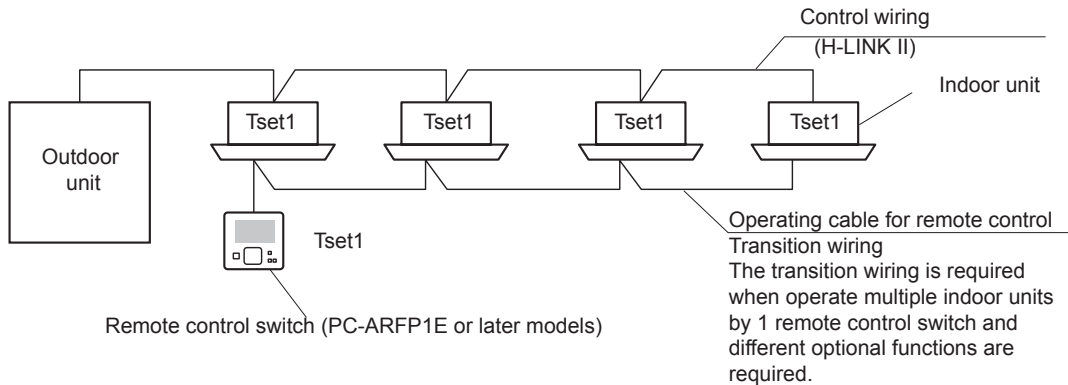

10.6.2 UTOPIA IVX Prime

The UTOPIA IVX Prime system remains in Thermo-ON as long as there is a load demand for one indoor unit. If the system is in Thermo-OFF, it will switch to Thermo-ON as soon as the first unit has load demand.

◆ Individual Operation (only available with UTOPIA IVX Prime)

In the individual operation control mode, each of the indoor units can have its independent temperature setting and Thermo-ON/OFF status (as well as optional functions), even connected to a same outdoor unit. Indoor units will switch on whenever they have load demand in an autonomous way, independently of other indoor unit needs.

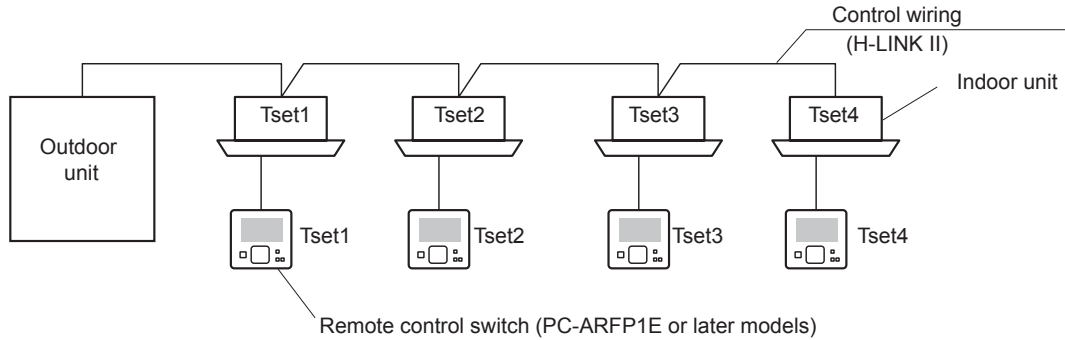

◆ Individual Thermo-ON/OFF Operation (group control, only available with UTOPIA IVX Prime)

In the individual Thermo-ON/OFF control mode, also known as group control, all indoor units connected to the same remote controller are sharing same operation mode (Tset, operation mode, fan speed, etc.). Even if sharing same operating parameters, each of them will have its independent Thermo-ON/OFF status, so they will switch on whenever they have load demand in an autonomous way, independently of other indoor unit needs.

Additionally can be set other parameters (optional functions like fan stop, etc) per each indoor unit.

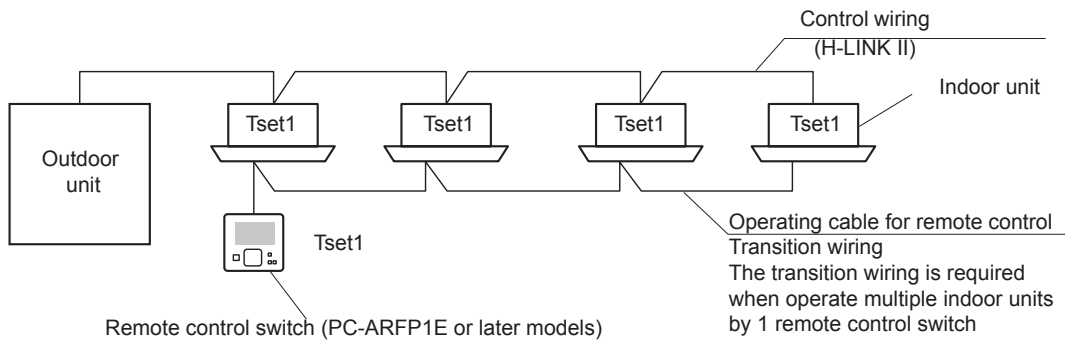

10.6.3 System control comparison

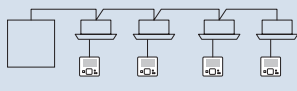
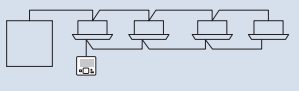
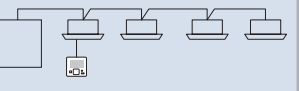
				
Control Method		Individual control	Group control	Simultaneous control
Operation Method		by one Remote Control Switch per each indoor unit	by one Remote Control Switch per each group	by only one Remote Control Switch
1	ON/OFF	Yes		
2	Setting of Operation Mode	Yes (*1)		
3	Room Temperature Setting	Yes		
4	Fan Speed Setting	Yes		
5	Timer Setting	Yes		
6	ON/OFF by Timer Control	Yes		
7	Operation Indication	Yes		
8	Alarm Indication	Yes		
9	Self-Checking	Yes		
10	Test Mode	Yes		
11	Individual Louver Setting	Yes (*2)		
12	Motion Sensor Setting	Yes (*3)		

 **NOTE**

Yes: Available

*1): Cooling and heating can not be operated simultaneously. Only if all units in one group are connected to the same outdoor unit.

*2): Only for RCI-FSR series with PC-ARFP1E or later models

*3): Only for units equipped with motion sensor + PC-ARFP1E or later models. Do not mix other indoor unit, air panel and remote control switch if set from one remote control switch.

11 . Troubleshooting

Index

11.1 On-screen displays during abnormal operation.....	118
11.2 Alarm codes	120

11.1 On-screen displays during abnormal operation

Abnormal operation can be produced due to the following reasons:

• **Malfunction**

The RUN (red) indicator flashes.

The ALARM indicator appears on the liquid crystal display.

The screen also displays the following items:

- A: indoor unit address.
- B: Refrigerant cycle number.
- C: Alarm code.
- D: Model code.
- E: If there are various indoor units connected, the above mentioned information is shown for each one of them.

Write down the indications and contact your Hitachi service supplier.

• **Power supply failure**

All displays disappear.

If the unit stops due to a power shortage, it will not start again, even though the power comes back on. Carry out the start-up operations again.

If the power failure lasts less than 2 seconds, the unit will start again automatically.

• **Electrical noise**

The displays can disappear from the screen and the unit can stop. This is because the microcomputer has been activated to protect the unit from electrical noise.

i NOTE

If the wireless remote control is used for the wall-type indoor unit, remove the connectors (CN25) that are connected to the indoor PCB. Otherwise the unit will not work. The stored data cannot be erased unless the remote control is initialised.

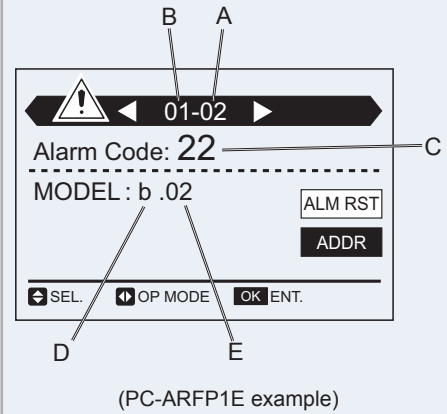

Model code	
Indication	Model
H	Heat pump
P	Inverter
F	Multi (SET-FREE)
C	Cooling only
E	Other
b	Prime and IVX Prime
L	KPI

◆ **PC-ARFP1E Troubleshooting help menu**

PC-ARFP1E remote controller have a Troubleshooting function in Help Menu.

Make sure that the troubleshooting is read carefully before requesting for repairs.

Select "Troubleshooting" from the help menu and press "OK". The list of troubleshooting will be displayed.

1 Select a problem from the list by pressing "▲" or "▼" and press "OK". The details of the selected problem will be displayed.

2 Press "▲" or "▼" to scroll the text up and down.

3 Press "↵" (return). The screen will return to the list of troubleshooting.

4 Press "↵" (return). The screen will return to the help menu.

To return to the normal mode, press "↵" (return) again.

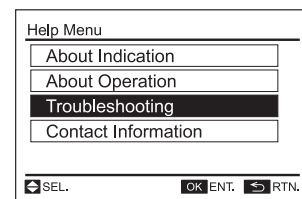
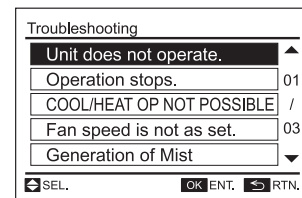
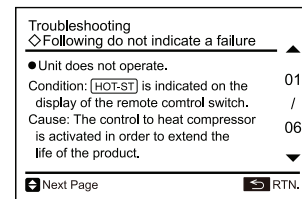
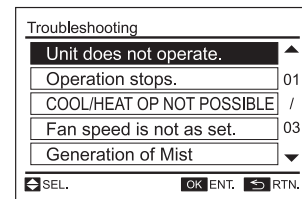
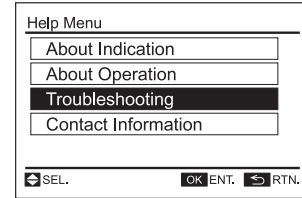
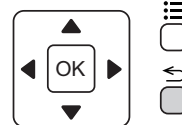
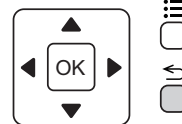
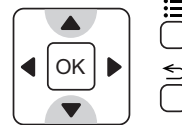
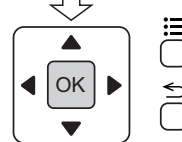
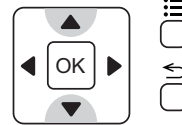
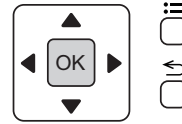
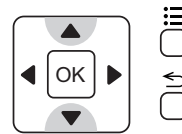

11.2 Alarm codes

Code	Category	Content of Abnormality	Leading Cause
01	Indoor unit	Activation of protection device (Float switch (*))	Activation of float switch (High water level in drain pan, abnormality of drain pipe, float switch, or drain pan)
02	Outdoor unit	Activation of protection device (High pressure cut or High compressor temperature cut)	Activation of PSH (pipe clogging, excessive refrigerant, inert gas mixing) or activation of High temperature compressor thermostat (shortage of refrigerant or system refrigerant leakage)
03	Communication	Abnormal communication between Indoor units and outdoor units	Incorrect wiring, loose terminals, disconnected communication cable, blowout of fuse, indoor unit power OFF, Outdoor fuse meltdown
04		Abnormal communication between inverter PCB and Outdoor PCB	Inverter PCB - outdoor PCB communication failure (loose connector, wire breaking, blowout of fuse)
05	Supply phase	Abnormality of power supply phases	Incorrect power supply, open-phase
06	Voltage	Abnormal inverter voltage	Outdoor voltage decrease, insufficient power capacity
07	Cycle	Decrease in discharge gas superheat	Excessive refrigerant charge, failure of thermistor, incorrect wiring, incorrect piping connection, expansion valve locking at opened position (Disconnect connector)
08		Excessively high discharge gas temperature	Insufficient Refrigerant Charge, Pipe Clogging, Failure of Thermistor, Incorrect Wiring, Incorrect Piping Connection, Expansion Valve Locking at Closed Position (Disconnect Connector)
09	Fan motor	Activation of protection device for outdoor fan	Fan motor overheat, locking
0A	Communication	Abnormal communication between outdoor units	Incorrect wiring, broken cable, loose terminals
0b	Outdoor unit	Incorrect outdoor unit address setting	Duplication of address setting for outdoor units (Sub units) in same refrigerant cycle number
0C		Main unit of the outdoor unit incorrectly set	Two (or more) outdoor units set as "Main Unit" exist in same refrigerant cycle number
11	Sensor on Indoor Unit	Abnormality of inlet air thermistor	Incorrect wiring, disconnecting wiring, breaking wire, short circuit
12		Abnormality of outlet air thermistor	
13		Abnormality of freeze protection thermistor	
14		Abnormality of gas piping thermistor	
15		Abnormality of outdoor air thermistor (Econofresh)	
16		Abnormality of remote sensor (DOAS)	
17	Abnormality of thermistor built-in remote Controller (DOAS)		
18	Indoor fan motor	Abnormality of indoor fan system	Abnormality of indoor fan motor (Step-out), indoor fan controller failure
19		Activation of protection device for indoor fan	Fan motor overheat, lockup
1A	Indoor fan controller	Abnormality of fan controller fin temperature	Abnormality of fin thermistor or fan controller, heat exchanger clogging, abnormality of fan motor
1b		Activation of overcurrent protection	Abnormality of fan motor
1C		Problem with current sensor	Abnormality of fan controller current sensor
1d		Activation fan controller protection	Driver IC error signal detection, instantaneous overcurrent
1E		Abnormality of indoor fan controller voltage	Indoor voltage decrease, insufficient capacity of power supply wiring
20	Sensor on Outdoor Unit	Abnormality of the compressor thermistor	Incorrect wiring, disconnecting wiring, breaking wire, short circuit
21		Abnormality of high pressure sensor	
22		Abnormality of outdoor air thermistor	
24		Abnormality of heat exchanger liquid pipe thermistor	

Code	Category	Content of Abnormality	Leading Cause
31	System	Incorrect capacity setting of outdoor unit and indoor unit	Incorrect capacity setting of outdoor unit and indoor unit, excessive or insufficient indoor unit total capacity code
32		Incorrect setting of other indoor unit number (RPK series only)	Problem with a different Indoor Unit in the same refrigerant cycle; (Failure at the power supply, defective PCB)
35		Incorrect indoor unit number setting	Duplication of indoor unit number in same refrigerant cycle number
36		Incorrect of indoor unit combination	Outdoor unit is R32 designed and there is at least one indoor unit not supporting R32 refrigerant.
38		Abnormality of picking up circuit for protection (outdoor unit)	Failure of protection detecting device (incorrect wiring of outdoor PCB)
3A	Outdoor Unit	Abnormal outdoor unit capacity	Outdoor unit capacity > Permitted maximum
3b		Incorrect setting of outdoor unit models combination or voltage	Incorrect setting of main and sub units(s) combination or voltage
3d		Abnormal communication between main unit and sub unit(s)	Incorrect wiring, disconnect wire, breaking wire, PCB failure
3E		Abnormal combination between inverter PCB and outdoor PCB	Incorrect combination between inverter PCB and outdoor PCB
43	Protection Device	Activation of the protection device from compression ratio decrease	Abnormal compression (failure of compressor or inverter, loose power supply connection)
44		Activation of the protection device from excessively high suction pressure	Overload during cooling, high temperature with heating, locked expansion valve
45		Activation of the protection device from excessively high discharge pressure	Overload (obstruction of Heat exchanger or clogging, short circuit) mixture of inert gas
47		Activation of the protection device from excessively low suction pressure (protection from vacuum operation)	Shortage or leakage of refrigerant, piping clogging, expansion valve close-locked, fan motor locked
48		Abnormality of current sensor for inverter	Overload operation, compressor failure, failure of DIP-IPM, heat exchanger clogged, locked compressor, EVI/EVO failure or overcharge
49	Outdoor Unit	Shortage of energy transfer at IDU and ODU side	Shortage of refrigerant due to gas leakage
50		Compressor continuously in operation under very low discharge pressure	Abnormality operation at a low ambient temperature
51	Sensor	Abnormality of current sensor for inverter	Current sensor failure
53	Inverter	Protection activation of inverter module	Driver IC error signal detection (inverter module abnormality, protection for overcurrent, voltage decrease, short circuit), instantaneous overcurrent. Failure of compressor, clogging of heat exchanger
54		Inverter fin temperature increase	Abnormal inverter fin thermistor, clogging of heat exchanger, abnormal outdoor fan.
55		Inverter Module abnormality	Failure of inverter module (PCB failure)
57	Fan Controller	Activation of fan controller protection	Driver IC error signal detection (protection for overcurrent, voltage decrease, short circuit), instantaneous overcurrent, disconnected wire or incorrect wiring between control PCB and inverter PCB, incorrect wiring or fan motor abnormality.
88		Alarm for abnormality of fan or compressor driver	The fan or the compressor driver do not transfer an identification code
5A		Abnormal fan controller fin temperature	Fin thermistor fault, heat exchanger clogging, fan motor fault
5b		Activation of overcurrent protection	Fan motor failure
5C		Abnormality of fan controller sensor	Failure of current sensor (instantaneous overcurrent, increase of fin temperature, low voltage, ground fault, step-out)
A1	Indoor Unit	Active filter abnormality detection	Active filter abnormality

Code	Category	Content of Abnormality	Leading Cause
b0	Indoor Unit	Incorrect setting of unit model code	Incorrect setting of indoor unit model
b1		Incorrect setting of unit and refrigerant cycle number	The setting number of the indoor units is over 64 or the indoor unit address not correct
b3		Wrong combination of indoor unit and remote control switches	Wrong combination of indoor unit and remote control switches
b2		Abnormality of EEPROM	EEPROM failure, incorrect data of EEPROM
b5		Incorrect indoor unit connection number setting	There are more than 17 units not corresponding to H-LINK II connected to one system
b6		Abnormal communication between indoor PCB and indoor fan controller (**)	Communication failure, disconnected communication cable, abnormal connection
b7		Transmission abnormality between the indoor and the PCB for 2 fans	Transmission abnormality between the indoor unit and the PCB for 2 fans
bF		Abnormality in the number of connected sub-PCB	Abnormality in the number of connected sub-PCB
EE	Compressor	Compressor protection alarm (it can not be reset from wired controller)	This alarm code appears when the following alarms* occurs three times within 6 hours *02, 07, 08, 39, 43 To 45, 47

**NOTE**

- (*) In the case of RPI-16/20, the fan motor of both units is stopped immediately upon occurrence of an alarm at either of the units (upper or lower side). The remote control switch indicates the cause of alarm (codes 1, 11, 12, 13, 14, 19) for the unit where the alarm has occurred, while alarm code 19 (Fan motor stoppage) is indicated for the other unit. Therefore it is necessary to check both units only in case of occurrence of alarm 19.
- (**) When the RUN indicator flashes every 4 seconds, there is a transmission failure between the indoor unit and the remote control switch (Loose connector, Incorrect Wiring, Disconnected Wire, Broken Wire).



Hitachi certifies that our products have met EU consumer safety, health and environmental requirements.



ER-0198/1996



GA-1999/0044

Johnson Controls-Hitachi Air Conditioning Spain, S.A.U. is certified with:
ISO 9001 of AENOR, Spain for its Quality Management accordance with the standard.
ISO 14001 of AENOR Spain for its Environmental Management systems accordance with the standard.



JQA-1084



EC97J1107

Hitachi air conditioning products are manufactured according to:
ISO 9001 of JQA, Japan for its Quality Management accordance with the standard.
ISO 14001 of JACO, Japan for its Environmental Management accordance with the standard.



Hitachi participates in the Eurovent Certification Programme; the certified data of certified models are listed in the Eurovent Certification Online Directory (www.eurovent-certification.com).

Cooling & Heating

Johnson Controls-Hitachi Air Conditioning Spain, S.A.U.
Ronda Shimizu, 1 - Políg. Ind. Can Torrella
08233 Vacarisses (Barcelona) Spain

© Copyright 2021 Johnson Controls-Hitachi Air Conditioning Spain, S.A.U. – All rights reserved.