

AIR CONDITIONER OPTIONAL PARTS

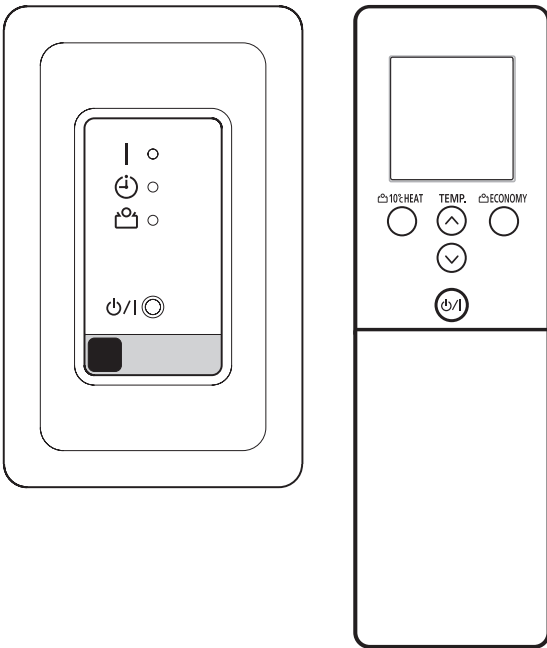

INSTALLATION MANUAL

IR receiver unit (for duct)
For authorized service personnel only.

English

INSTALLATIONSANLEITUNG

IR-Empfängereinheit (Für Luftkanalsysteme)
Nur für autorisiertes Fachpersonal.

Deutsch

MANUEL D'INSTALLATION

Kit Récepteur IR (pour conduit)
Pour le personnel de service agréé uniquement.

Français

MANUAL DE INSTALACIÓN

Unité de réception infrarouge (para ducto)
Únicamente para personal de servicio autorizado.

Español

MANUALE D'INSTALLAZIONE

Unidad receptora de infrarrojos (per condotto)
A uso esclusivo del personale tecnico autorizzato.

Italiano

ΕΓΧΕΙΡΙΔΙΟ ΕΓΚΑΤΑΣΤΑΣΗΣ

Μονάδα δέκτη IR (αγωγού)
Μόνο για εξουσιοδοτημένο τεχνικό προσωπικό.

Ελληνικά

MANUAL DE INSTALAÇÃO

Unidade do recetor de infravermelhos (para conduta)
Somente para o pessoal do serviço técnico autorizado.

Português

РУКОВОДСТВО ПО УСТАНОВКЕ

ИК-приемник (для кассетного типа)
Только для авторизованного обслуживающего персонала.

Русский

KURULUM KILAVUZU

Kızılötesi alıcı ünite (Oluk için)
Yalnızca yetkili servis personeli için.

Türkçe



PART NO. 9378626072

INSTALLATION MANUAL

PART No. 9378626072
IR receiver unit (for duct)

Contents

1. SAFETY PRECAUTIONS	1
2. ACCESSORIES	1
3. OPTIONAL PARTS.....	2
4. FUNCTIONS AND DIMENSIONS	2
5. SELECTING THE INSTALLATION LOCATION	2
6. INSTALLING THE RECEIVER UNIT	
6.1. Select the wiring pattern.....	3
6.2. Select the installation method	3
7. WIRING.....	3
8. TURNING ON THE POWER.....	4
9. SETTING THE REMOTE CONTROLLER	
9.1. Load batteries (R03/LR03 × 2).....	4
9.2. Installing the remote controller holder.....	4
10. FUNCTION SETTING	5
11. SELECTING THE REMOTE CONTROLLER CUSTOM CODE.....	5
12. TEST RUN	5
13. ERROR CODES	6

1. SAFETY PRECAUTIONS











- Let the customer keep this installation manual because it is needed when the air conditioner or receiver unit is serviced or moved.

⚠ WARNING	This mark indicates procedures which, if improperly performed, might lead to the death or serious injury of the user.
<ul style="list-style-type: none"> Never touch electrical components immediately after the power supply has been turned off. Electrical shock may occur. After turning off the power, always wait 5 minutes or more before touching electrical components. 	
<ul style="list-style-type: none"> For the air conditioner to operate satisfactorily, install it as outlined in this installation manual. 	
<ul style="list-style-type: none"> Installation work must be performed in accordance with national wiring standards by authorized personnel only. 	
<ul style="list-style-type: none"> Do not cut, shorten, or extend the cable in the standard parts. 	
<ul style="list-style-type: none"> Do not turn on the power until all installation work is complete. 	

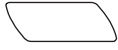
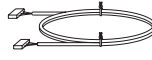
⚠ CAUTION	This mark indicates procedures which, if improperly performed, might possibly result in personal harm to the user, or damage to property.
<ul style="list-style-type: none"> Do not wire the receiver unit wire together with or parallel to the connection cables, transmission cables, remote controller cables, bus cable and power supply cables of the indoor and outdoor units. It may cause erroneous operation. 	
<ul style="list-style-type: none"> Do not install the receiver unit cable near a source of electromagnetic waves. 	
<ul style="list-style-type: none"> Do not install where there is the danger of combustible gas leakage. 	
<ul style="list-style-type: none"> Do not install near heat sources, steam. 	

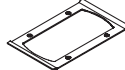
2. ACCESSORIES

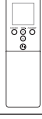
The following installation parts are supplied.
Use them as required.

Name and Shape	Q'ty	Application
Installation manual 	1	This manual
Operating manual 	1	Instruction book for operation
Receiver unit 	1	For receiving the signal from the remote controller
Cover 	1	For covering receiver unit
Insulation 	1	For protecting PCB from dust
Receiver unit wire A 5m 	1	For connecting receiver unit wire B to receiver unit
Receiver unit wire B 0.2m 	1	For connecting receiver unit wire A to PCB of indoor unit
Bracket (cover) 	1	For fixing receiver unit to the wall or ceiling
Screw (M3 x 12mm) 	2	For installing remote controller holder to the wall
Screw (M4 x 20mm) 	2	For installing receiver unit to the wall or ceiling
Remote controller 	1	For air conditioner operation
Battery (R03/LR03) 	2	For remote controller
Remote controller holder 	1	Use as remote controller holder

3. OPTIONAL PARTS

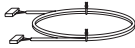
Name and Shape	Q'ty	Application	Part No.
Receiver unit wire C 10m 	1	For extending the receiver unit wire	9710358012

4. FUNCTIONS AND DIMENSIONS

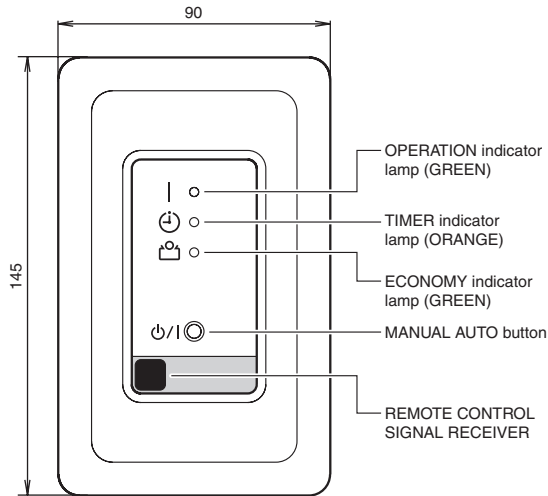

Dimensions

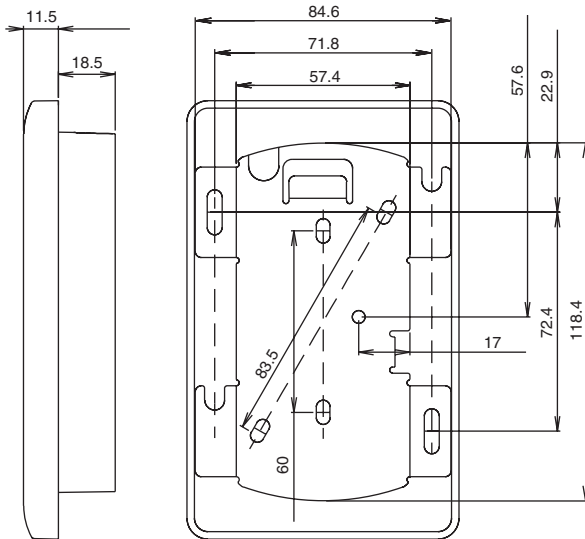

Unit: mm

5. SELECTING THE INSTALLATION LOCATION

Consult the customer and determine the installation location according to the following:

- (1) The receiver unit cable can be extended up to 10m. (To extend the wiring, purchase the optional receiver unit wire C.)
- (2) The signal reception angle of the receiver unit is shown in the figures below.
- (3) Do not install the receiver unit near a fluorescent light. (The unit must be at least 1m away from a light source.)
- (4) Do not install the receiver unit where it will be exposed to direct sunlight.
- (5) Do not install the receiver unit where it will be exposed directly to the airflow from the indoor unit.

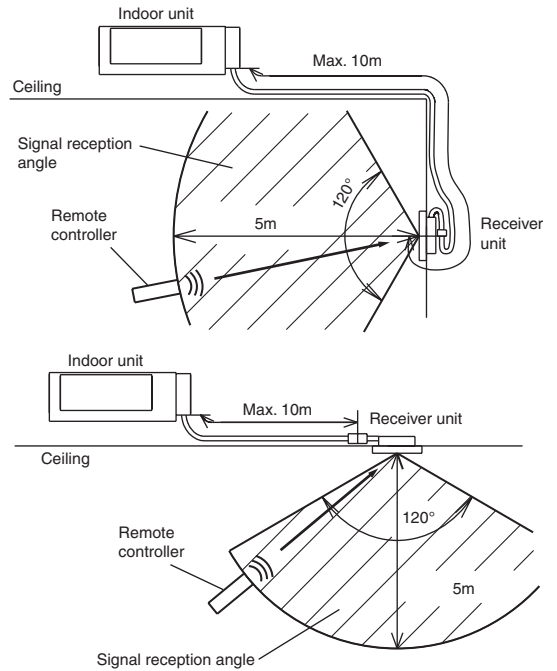

6. INSTALLING THE RECEIVER UNIT

CAUTION

- Do not touch the PCB or PCB parts of receiver unit directly with your hands.
- Fixing of the holder cover with the screws in the standard parts may be unsuitable if the wall or ceiling material is weak. If so, prepare screws suitable for the wall or ceiling material, and fix it.

6.1. Select the wiring pattern

Pattern A From the top of the receiver unit: No additional work is necessary.

Pattern B From behind the receiver unit: Perform the following procedure to route the wiring behind the receiver unit.

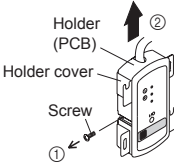
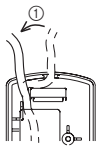
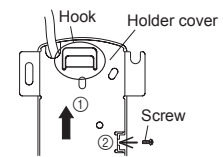
 <p>1 Remove the screw. 2 Remove holder (PCB) from holder cover.</p>	 <p>1 Route the wiring as shown in the figure.</p>
 <p>1 Reattach holder cover. (Make sure that the hook on the holder cover is caught on the holder [PCB].) 2 Fix holder (PCB) by the screw.</p>	

6.2. Select the installation method



Method 1 Receiver unit embedded in a wall or ceiling:
Refer to "I. Embedding the receiver unit."

Method 2 Receiver unit attached to a wall or ceiling:
Refer to "II. Attaching the receiver unit."

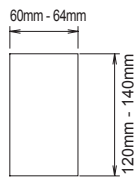
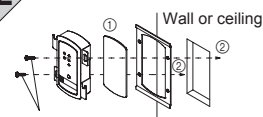
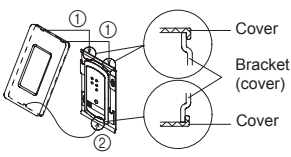
I. Embedding the receiver unit (Wiring pattern A or B)

	 <p>1 Affix the insulation to the holder cover. 2 Attach the holder cover and bracket (cover) to the wall or ceiling with the screws (included with the standard parts).</p>
 <p>1 Install the cover. Hook the 2 projections on the top of the cover onto the bracket (cover), and then hook the projection on the bottom of the cover onto the bracket (cover). 2 Make sure that there is no gap between the cover and the wall or ceiling.</p>	

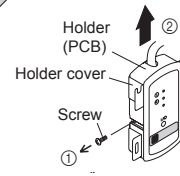
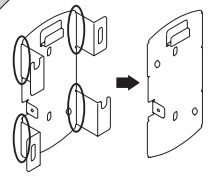
II. Attaching the receiver unit (Wiring pattern A)

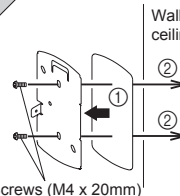
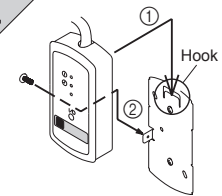
 <p>1 Remove the screw. 2 Remove holder (PCB) from holder cover.</p>	 <p>1 Cut the projections in the areas indicated with a  and remove them. (Be careful not to injure yourself on the cut edges of the holder cover.)</p>
 <p>1 Affix the insulation to the holder cover. 2 Attach the holder cover to the wall or ceiling with the screws (included with the standard parts).</p>	
 <p>1 Reattach holder cover. (Make sure that the hook on the holder cover is caught on the holder [PCB].) 2 Fix holder (PCB) by the screw.</p>	

7. WIRING

⚠ WARNING

- Before starting work, make sure that power is not being supplied to the indoor unit.
- Always fasten the outside covering of the connection cord with the cord clamp. (If the insulator is chafed, electric leakage may occur.)

⚠ CAUTION

- Do not touch the PCB or PCB parts of indoor unit directly with your hands.
- When fixing the wiring, be careful to avoid touching the edge of the indoor unit or the control box.
- Install the remote controller wires so as not to be direct touched with your hand.
- Make sure to use and roll an insulation tube of more than 1 mm thick at the connection point of the receiver unit wire A and the receiver unit wire B.

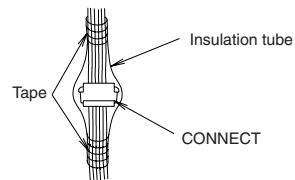

PROCEDURE

Please refer to the installation manual of each indoor unit for details.

If the wiring length is 10m, replace with receiver unit wire C (optional parts).
Receiver unit wire A 5m

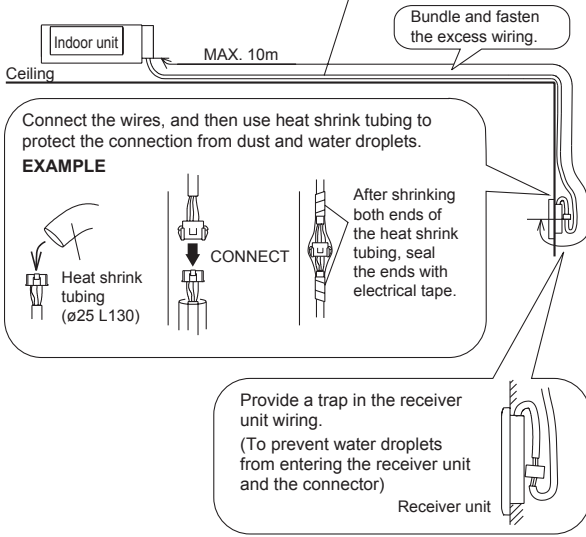

8. TURNING ON THE POWER

- ① Turn on the breaker.
- ② Make sure that the operation indicator lamp and timer indicator lamp are slowly flashing alternately.
 - If the auto restart function has been set, the air conditioner will operate with the settings immediately before the power supply was turned off.
 - If an error has occurred, the lamps on the receiver unit will flash quickly to indicate the error code. (Referring to 13 of this installation manual)

9. SETTING THE REMOTE CONTROLLER

9.1. Load batteries (R03/LR03 × 2)

⚠ WARNING

- Take care to prevent infants and young children from accidentally swallowing the batteries.

⚠ CAUTION

- Do not attempt to recharge dry batteries.
- Do not use dry batteries that has been recharged.
- When not using the remote controller for an extended period, remove the batteries to avoid possible leakage and damage to the unit.
- If leaking battery fluid comes in contact with your skin, eyes, or mouth, immediately wash with copious amounts of water, and consult your physician.
- Dead batteries should be removed immediately and disposed of properly, either in a battery collection receptacle or to the appropriate authority.

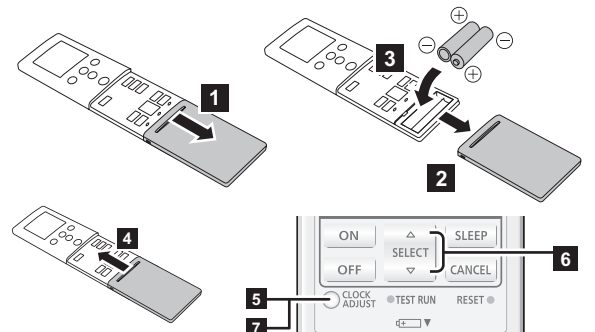

- 5 Press "CLOCK ADJUST" button to start clock setting.
- 6 Set the time by pressing "SELECT (Δ ∇)" button. *By pressing the "TEMP. (Λ ∇)" buttons, the time indicator can be changed from a 24-hour to a 12-hour clock.
Pressing Δ or ∇ changes the value by the minute.
Pressing down on Δ or ∇ changes the value by 10 minutes.
- 7 To complete, press the "CLOCK ADJUST" button again close to the indoor unit. Settings may not be properly sent if pressed from a distance.

Notes:

- Use specified type of batteries only.
- Do not mix different types or new and used batteries together.
- Batteries can be used about 1 year in ordinary use.
- If the remote control range noticeably shortens, or the display is pale or difficult to see, replace the batteries, and press the "RESET" button as shown in page 4.

9.2. Installing the remote controller holder

Check that the indoor unit correctly receives the signal from the remote controller, then install the remote controller holder.

⚠ CAUTION

Do not install the remote controller holder in the following conditions:

- Any places exposed in direct sunlight
- Positions affected by the heat from a stove or heater

- Install the remote controller a maximum distance of 5 m from the remote control signal receiver. After installing the remote controller, check that it operates correctly.
- Install the remote controller holder to a wall, pillar, etc. with the tapping screw.

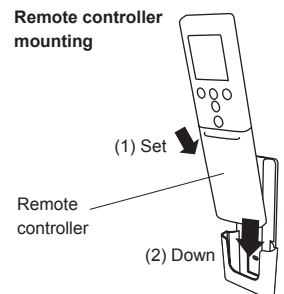
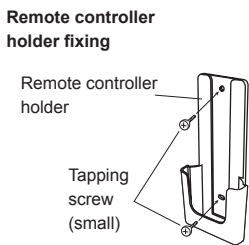

10. FUNCTION SETTING

Perform the "FUNCTION SETTING" according to the installation conditions using the remote controller.

CAUTION

- Confirm whether the wiring work for outdoor unit has been finished.
- Confirm that the cover for the electrical enclosure on the outdoor unit is in place.

- This procedure changes to the function settings used to control the indoor unit according to the installation conditions. Incorrect settings can cause the indoor unit to malfunction.
- After the power is turned on, perform the "FUNCTION SETTING" according to the installation conditions using the remote controller.
- The settings may be selected between the following two: Function Number or Setting Value.
- Settings will not be changed if invalid numbers or setting values are selected.
- Refer to the installation manual enclosed with the remote controller when the wired remote controller (option) is used.

Selecting the Function Number and Setting Value

- (1) While pressing the "ECONOMY" button and "TEMP." (Λ) button simultaneously, press the "RESET" button to enter the function setting mode.
- (2) Press the "10°C HEAT" button

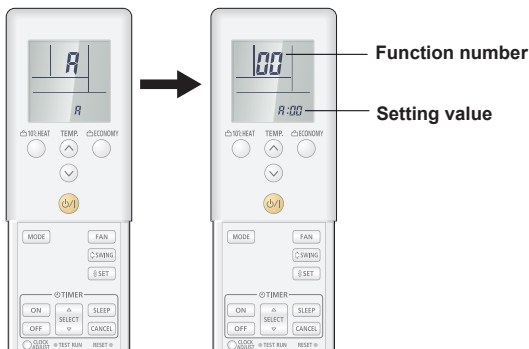

- (3) Press the "TEMP." (Λ / √) buttons to select the function number. (Press the "10°C HEAT" button to switch between the left and right digits.)
- (4) Press the "ECONOMY" button to proceed to setting value. (Press the "ECONOMY" button again to return to the function number selection.)
- (5) Press the "TEMP." (Λ / √) buttons to select the setting value. (Press the "10°C HEAT" button to switch between the left and right digits.)
- (6) Press the "MODE" button once to send the function setting information. Please confirm the beeping sound.
- (7) Next, please press "Start/Stop (ϕ/I)" button once to fix the function setting. Please confirm the beeping sound.
- (8) Press the "RESET" button to cancel the function setting mode.
- (9) After completing the FUNCTION SETTING, be sure to turn off the power and turn it on again.

CAUTION

- After turning off the power, wait 30 seconds or more before turning on it again. The function setting does not become active unless the power is turned off then on again.

Remote controller custom code

(Only for wireless remote controller)

The indoor unit custom code can be changed. Select the appropriate custom code.

(♦... Factory setting)

Setting Description	Function Number	Setting Value
♦ A	44	00
B		01
C		02
D		03

Function Details

To change the function settings, refer to the installation manual of the indoor unit.

11. SELECTING THE REMOTE CONTROLLER CUSTOM CODE

When two or more air conditioners are installed in a room and the remote controller is operating an air conditioner other than the one you wish to set, change the custom code of the remote controller to operate only the air conditioner you wish to set (4 selections possible).

When two or more air conditioners are installed in a room, please contact your retailer to set the individual air conditioner custom codes.

Selecting the Remote Controller Custom Code

Use the following steps to select the custom code of the remote controller. (Note that the air conditioner cannot receive a signal if the air conditioner has not been set for the matching custom code.)

- (1) Press the "Start/Stop (ϕ/I)" button until only the clock is displayed on the remote controller display.
- (2) Press the "MODE" button for at least 5 seconds to display the current custom code (initially set to A).
- (3) Press the "TEMP." (Λ / √) buttons to change the custom code between A→B→C→D. Match the code on the display to the air conditioner custom code.
- (4) Press the "MODE" button again to return to the clock display. The custom code will be changed.



- If no buttons are pressed within 30 seconds after the custom code is displayed, the system returns to the original clock display. In this case, start again from step 1.
- The air conditioner custom code is set to A prior to shipment.

12. TEST RUN

Check items

- (1) Is operation of each button on the remote control unit normal?
 - (2) Does each lamp light normally?
 - (3) Do air flow direction louvers operate normally?
 - (4) Is the drain normal?
 - (5) Do not have an abnormal noise and vibration during operation?
- Do not operate the air conditioner in test run for a long time.

[Operation method]

- For the operation method, refer to the operating manual.
- The outdoor unit, may not operate, depending on the room temperature. In this case, keep on pressing the "MANUAL AUTO" button of the indoor unit for more than 10 seconds. The OPERATION indicator lamp and TIMER indicator lamp will begin to flash simultaneously during cooling test run.

Then, heating test run will begin in about 3 minutes when HEAT is selected by the remote controller operation [reverse cycle model only]. (Please follow the operating manual for remote controller operation.)

- To end test operation, press the remote controller "Start/Stop (ϕ/I)" button. (When the air conditioner is running by pressing the "TEST RUN" button, the OPERATION Lamp and TIMER Lamp will simultaneously flash slowly.)

13. ERROR CODES

If you use a wired type remote control, error codes will appear on the remote control display. If you use a wireless remote control, the lamp on the IR receiver unit will output error codes by way of blinking patterns. See the lamp blinking patterns and error codes in the table below.

An error display is displayed only during operation.

Error display			Wired remote controller Error code	Description
OPERATION lamp (green)	TIMER lamp (orange)	ECONOMY lamp (green)		
●(1)	●(1)	◇	11	Serial communication error
●(1)	●(2)	◇	12	Wired remote controller communication error
●(1)	●(5)	◇	15	Check run unfinished Automatic airflow adjustment error
●(1)	●(6)	◇	16	Peripheral unit transmission PCB connection error
●(1)	●(8)	◇	18	External communication error
●(2)	●(1)	◇	21	Unit number or Refrigerant circuit address setting error [Simultaneous Multi]
●(2)	●(2)	◇	22	Indoor unit capacity error
●(2)	●(3)	◇	23	Combination error
●(2)	●(4)	◇	24	• Connection unit number error (indoor secondary unit) [Simultaneous Multi] • Connection unit number error (indoor unit or branch unit) [Flexible Multi]
●(2)	●(6)	◇	26	Indoor unit address setting error
●(2)	●(7)	◇	27	Primary unit, secondary unit setup error [Simultaneous Multi]
●(2)	●(9)	◇	29	Connection unit number error in wired remote controller system
●(3)	●(1)	◇	31	Power supply interruption error
●(3)	●(2)	◇	32	Indoor unit PCB model information error
●(3)	●(3)	◇	33	Indoor unit motor electricity consumption detection error
●(3)	●(5)	◇	35	Manual auto switch error
●(3)	●(9)	◇	39	Indoor unit power supply error for fan motor

Error display			Wired remote controller Error code	Description
OPERATION lamp (green)	TIMER lamp (orange)	ECONOMY lamp (green)		
●(3)	●(10)	◇	3A	Indoor unit communication circuit (wired remote controller) error
●(4)	●(1)	◇	41	Room temp. sensor error
●(4)	●(2)	◇	42	Indoor unit heat ex. middle temp. sensor error
●(4)	●(4)	◇	44	Human sensor error
●(5)	●(1)	◇	51	Indoor unit fan motor error
●(5)	●(3)	◇	53	Drain pump error
●(5)	●(7)	◇	57	Damper error
●(5)	●(15)	◇	5U	Indoor unit error
●(6)	●(1)	◇	61	Outdoor unit reverse/missing phase and wiring error
●(6)	●(2)	◇	62	Outdoor unit main PCB model information error or communication error
●(6)	●(3)	◇	63	Inverter error
●(6)	●(4)	◇	64	Active filter error, PFC circuit error
●(6)	●(5)	◇	65	Trip terminal L error
●(6)	●(8)	◇	68	Outdoor unit rush current limiting resistor temp. rise error
●(6)	●(10)	◇	6A	Display PCB microcomputers communication error
●(7)	●(1)	◇	71	Discharge temp. sensor error
●(7)	●(2)	◇	72	Compressor temp. sensor error
●(7)	●(3)	◇	73	Outdoor unit Heat Ex. liquid temp. sensor error
●(7)	●(4)	◇	74	Outdoor temp. sensor error

Error display			Wired remote controller Error code	Description
OPERATION lamp (green)	TIMER lamp (orange)	ECONOMY lamp (green)		
●(7)	●(5)	◇	75	Suction Gas temp. sensor error
●(7)	●(6)	◇	76	• 2-way valve temp. sensor error • 3-way valve temp. sensor error
●(7)	●(7)	◇	77	Heat sink temp. sensor error
●(8)	●(2)	◇	82	• Sub-cool Heat Ex. gas inlet temp. sensor error • Sub-cool Heat Ex. gas outlet temp. sensor error
●(8)	●(3)	◇	83	Liquid pipe temp. sensor error
●(8)	●(4)	◇	84	Current sensor error
●(8)	●(6)	◇	86	• Discharge pressure sensor error • Suction pressure sensor error • High pressure switch error
●(9)	●(4)	◇	94	Trip detection
●(9)	●(5)	◇	95	Compressor rotor position detection error (permanent stop)
●(9)	●(7)	◇	97	Outdoor unit fan motor 1 error
●(9)	●(8)	◇	98	Outdoor unit fan motor 2 error
●(9)	●(9)	◇	99	4-way valve error
●(9)	●(10)	◇	9A	Coil (expansion valve) error
●(10)	●(1)	◇	A1	Discharge temp. error
●(10)	●(3)	◇	A3	Compressor temp. error
●(10)	●(4)	◇	A4	High pressure error
●(10)	●(5)	◇	A5	Low pressure error
●(13)	●(2)	◇	J2	Branch boxes error [Flexible Multi]

Display mode ● : 0.5s ON / 0.5s OFF

◇ : 0.1s ON / 0.1s OFF

() : Number of flashing