

DESIGN & TECHNICAL MANUAL

Compact series (Single phase type)

WATERSTAGE™

INNOVATIVE SOLUTION OF DOMESTIC HEATING

**Air to Water
Monobloc type**



CONTENTS

1. MONOBLOC UNIT

SINGLE PHASE TYPE : WP*A080LA, WP*A100LA

2. CONTROL SYSTEM

UTW-SCB*A (Control box)

WATERSTAGE™

1. MONOBLOC UNIT

SINGLE PHASE TYPE :

WP*A080LA

WP*A100LA

CONTENTS

1. MONOBLOC UNIT

1. FEATURES	MO01 - 01
2. SPECIFICATIONS	MO01 - 05
2-1. NOMINAL CAPACITY AND NOMINAL INPUT	MO01 - 05
2-2. TECHNICAL SPECIFICATIONS	MO01 - 06
2-3. ELECTRICAL SPECIFICATIONS	MO01 - 07
3. DIMENSIONS	MO01 - 08
3-1. DIMENSIONAL DRAWING	MO01 - 08
3-2. INSTALLATION PLACE	MO01 - 09
4. PIPING DIAGRAM	MO01 - 11
5. WIRING DIAGRAM	MO01 - 12
5-1. WIRING DIAGRAM	MO01 - 12
6. CAPACITY TABLES	MO01 - 13
6-1. HEATING CAPACITY	MO01 - 13
6-2. COOLING CAPACITY	MO01 - 15
7. OPERATION NOISE	MO01 - 17
7-1. NOISE LEVEL CURVE	MO01 - 17
7-2. SOUND LEVEL CHECK POINT	MO01 - 18
8. OPERATION RANGE	MO01 - 19
9. HYDRAULIC PERFORMANCE	MO01 - 20
9-1. STATIC PRESSURE DROP UNIT	MO01 - 20
10. SAFETY DEVICES	MO01 - 21
11. STANDARD ACCESSORIES	MO01 - 22

1. FEATURES

MODELS :

WP*A080LA, WP*A100LA



FEATURES

Compact design

Compact model

Comfort and energy saving realized by world's top class compact design

8kW 10kW



WP*A080LA
WP*A100LA



Control box
UTW-SCB*A

- Compact & Light weight design



- All-in-one model

Compact design which built in all hydraulic components and the heat pump unit make refrigerant piping work unnecessary. Easy installation and maintenance are realized.



Easy
installation &
maintenance!

WATERSTAGE outline (Monobloc type)

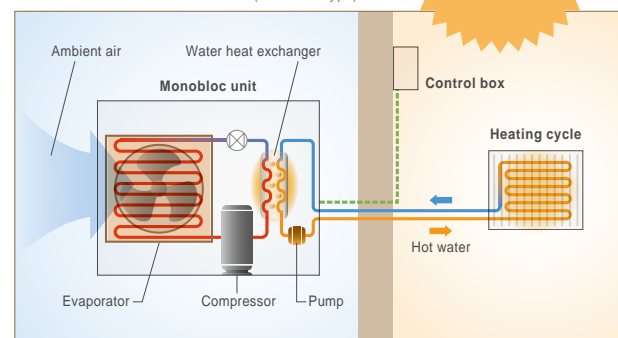

● High performance

High efficiency technology

DC INVERTER
Smooth water temperature control realized by DC inverter control.

HIGH EFFICIENT PLATE WATER HEAT EXCHANGER
Very compact size achieved by a thin high-efficiency heat exchanger

DC FAN MOTOR
High performance, high efficiency small DC fan motor mounted.

DC TWIN ROTARY COMPRESSOR
High efficient DC twin rotary compressor corresponding to low outdoor temperature

• High COP

High COP is realized by using a DC twin rotary compressor, inverter technology, and high efficient water heat exchanger.



*Condition : Outdoor Temp. 7°C Heating Temp. 35°C.

• High leaving water temperature

High leaving water temperature of 55°C keeps to -20°C of outdoor temperature without heater.

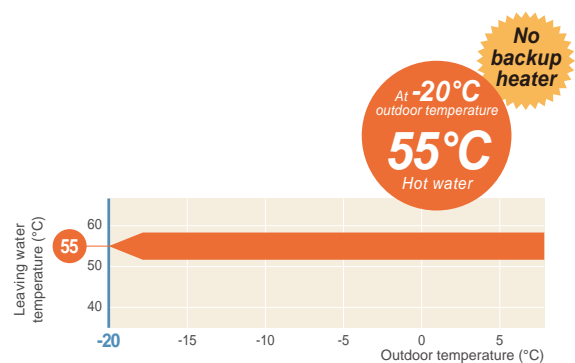

• Wide operation range

Possible to operate heating under -20°C of outdoor temperature.

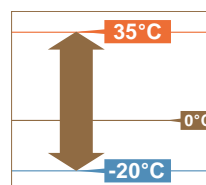

● Extensibility

Wide Comfort

Wide comfort by **WATERSTAGE**

The clean energy produced by **WATERSTAGE** reliably delivers “comfort” to diverse spaces in the home up to the living room, bedrooms, bath and swimming pool.

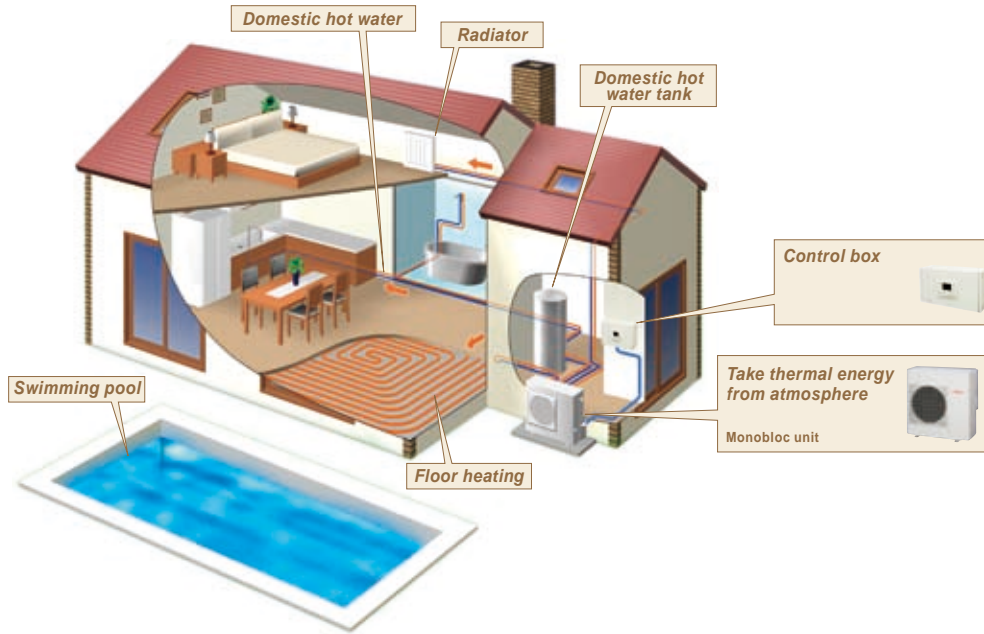

• System Configuration

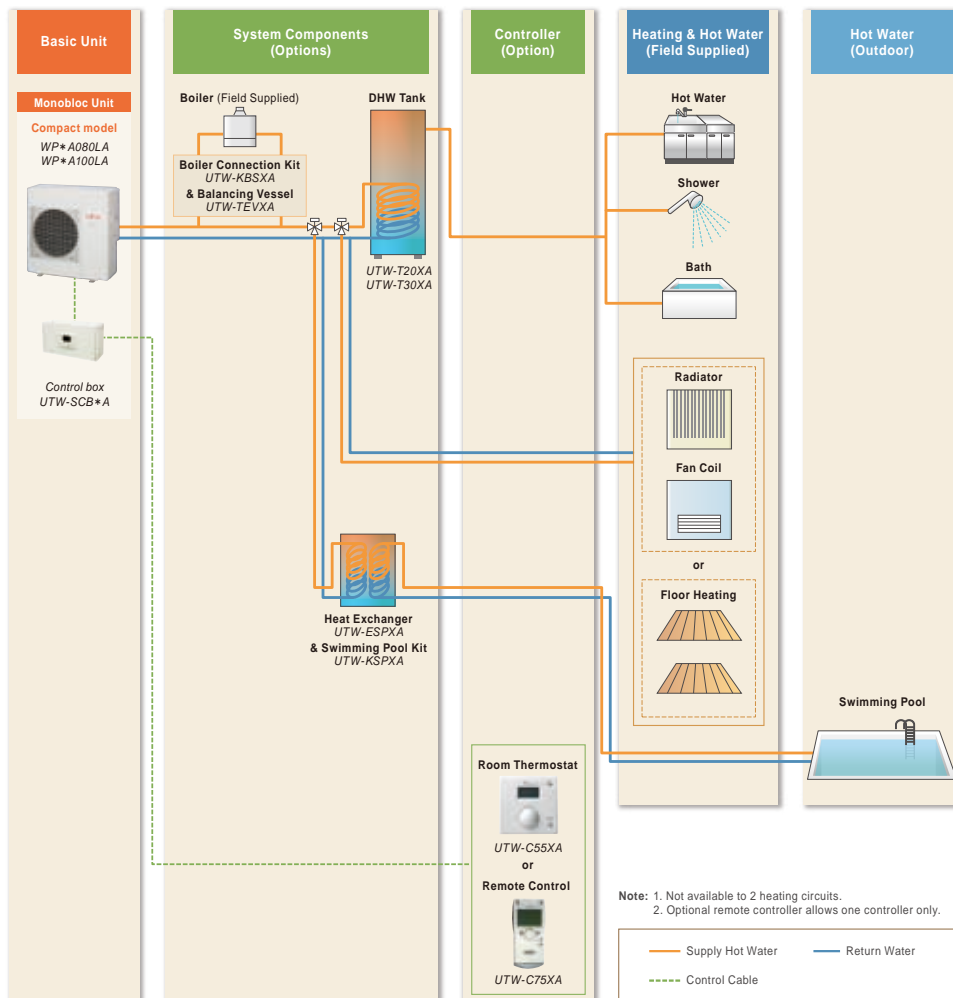

● High reliability

- Anti-freeze function

Water circulation and compressor can be automatically performed at low outdoor temperature. Freezing of circulated water can be prevented.

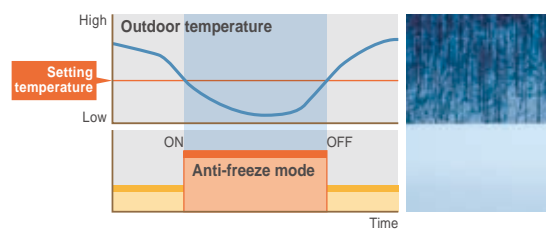

- Easy installation & maintenance
 - No installation of refrigerant circuit connections.
 - Closed type enables decrease in the supply frequency of circulating water.
 - Easy access for maintenance operations

2. SPECIFICATIONS

2-1. NOMINAL CAPACITY AND NOMINAL INPUT

Model name (Monobloc unit)			WP*A080LA	WP*A100LA	
+7°C/+35°C floor heating	Heating capacity	Minimum	2.41		
		Nominal	8.00	10.00	
		Maximum	11.32		
	Input power	Nominal	1.78	2.30	
COP	-		4.50	4.35	
+7°C/+45°C radiators	Heating capacity	Minimum	3.69		
		Nominal	7.80	9.80	
		Maximum	10.33		
	Input power	Nominal	2.23	2.88	
COP	-		3.50	3.40	
+2°C/+35°C floor heating	Heating capacity	Nominal	kW	7.40	8.10
	Input power		-	2.73	3.00
	COP		-	2.71	2.70

2-2. TECHNICAL SPECIFICATIONS

Model name (Monobloc unit)				WP*A080LA	WP*A100LA	
Enclosure	Colour			BEIGE		
	Material			Steel sheet		
Dimensions (H x W x D)	Net	mm	881.5 x 850 x 330			
	Gross		1,040 x 945 x 555			
Weight	Net	kg (lb.)	82 (181)			
	Gross		88 (194)			
Main components	Pump	Type	Water cooled			
		Nr.of speed	3			
	Input power		W	116 *		
	Water side Heat exchanger	Type		Braze plate		
		Q'ty		1		
		Water volume	l	1.8		
	Water flow rate Nom.	Water flow rate Min.	l/min	10		
		Heating	l/min	22.9	28.7	
		Cooling		18.3	20.4	
	Expansion vessel	Insulation material		EPDM form		
		Volume	l	8		
Max.water pressure		bar	4.5			
Pre pressure	1bar(+/-20%)					
Water circuit	Piping connections diameter		inch	1		
	Piping			1		
	Safety valve		bar	3		
	Manometer			Yes		
	Drain valve/Fill valve			YES/NO		
	Air purge valve			YES		
Heat exchanger type	Dimensions (H x W x D)		mm	840 x 788.2 x 36.4		
	Fin pitch			1.4		
	Rows & Stages			2 x 40		
	Pipe type			Copper		
	Fin	Type (Material)		Corrugate (Aluminum)		
Surface treatment		Corrosion resistance				
Fan	Airflow rate	Heating	m ³ /h	1,910		
	Type x Q'ty			Propeller x 1		
	Discharge direction			Horizontal		
	Motor Quantity			1		
	Motor output		W	100		
Compressor	Type x Q'ty			DC 2 rotary x 1		
	Motor output		W	1,700		
Operation range	Heating	Min	°CDB	-20		
		Max		35		
	Sanitary water	Min		-20		
		Max		35		
Water side	Heating	°C	8 to 55			
Sound pressure level	Heating		dBA	51		
Refrigerant	Type			R410A		
	Charge		g	1,500		
	Control			Expansion valve (electric type)		
	Nr of circuits			1		
Refrigerant oil	Type			FV50S		
	Charged volume		l	0.90		
Connection pipe	Drain	Q'ty	1			
		Size	mm	18		
	Method			Hole		
Defrost method			Reverse cycle			
Defrost control			Outdoor defrost temperature sensor			
Capacity control method			Inverter control			

*: The value is at Full speed and full flow

2-3. ELECTRICAL SPECIFICATIONS

Model name (Monobloc unit)			WP*A080LA	WP*A100LA
Available voltage range			1N~ 196 to 253V 50Hz	
Power supply	Voltage	V	1N~ 230V	
	Frequency	Hz	50	
*1) Max. operating current	Heating	A	16.1	18.3
*2) Starting current			—	—
*3) Wiring spec.	Main fuse (Circuit breaker) Current		25.0	
	Power cable	mm ²	3.5 to 4.0	
Wiring connections	For power supply	Quantity	3	
	For connection with control box		4	
		Remark	Included earth wiring	

*1) The maximum current is the total current of indoor unit and outdoor unit.

*2) The compressor with inverter control has low electrical power consumption at start-up.

*3) Wiring spec. :

Selected sample

(Selected based on Japan Electrotechnical Standard and Codes Committee E0005)

3. DIMENSIONS

3-1. DIMENSIONAL DRAWING

■ MODELS : WP*A080L, WP*A100L

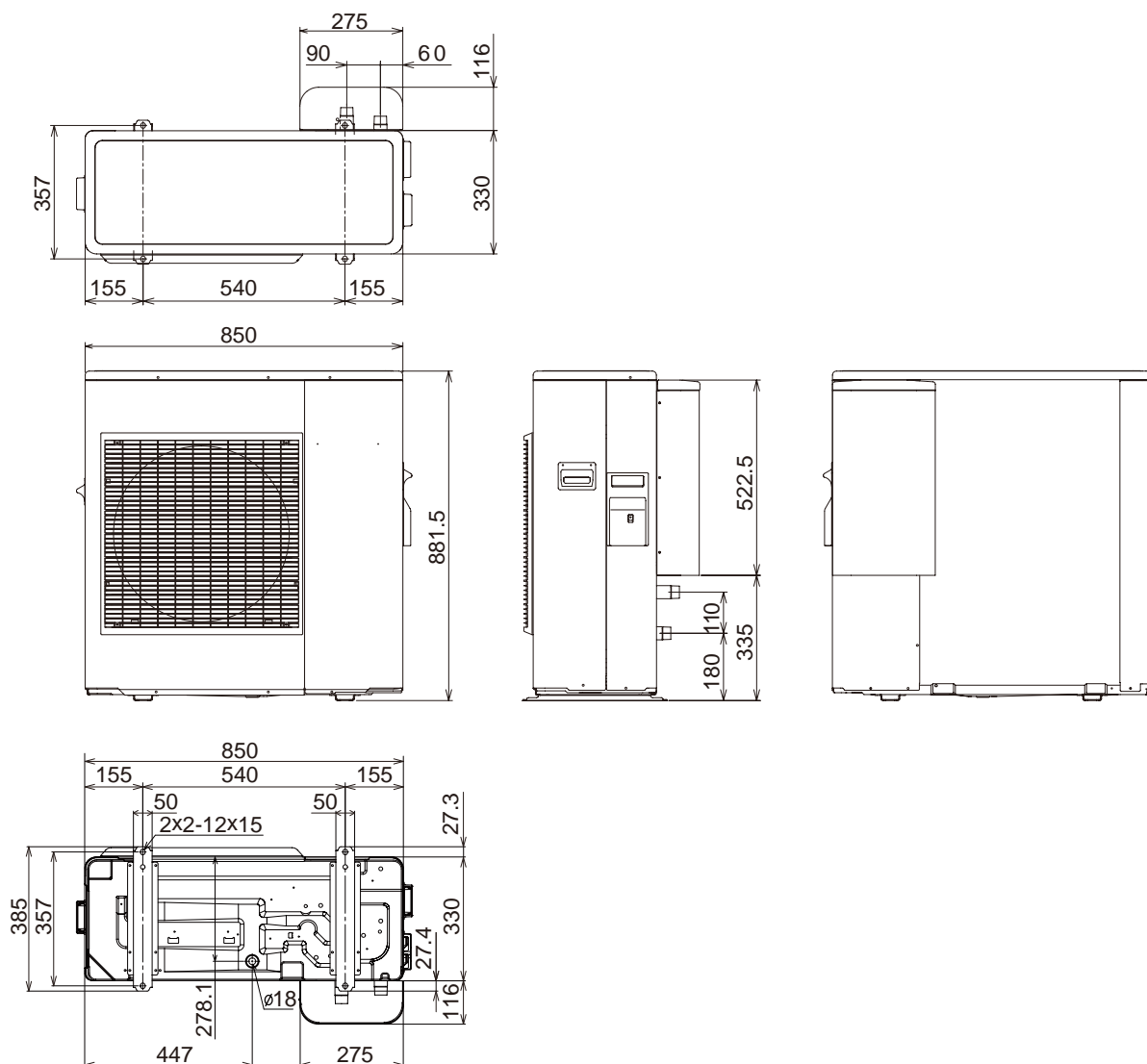

● Main components

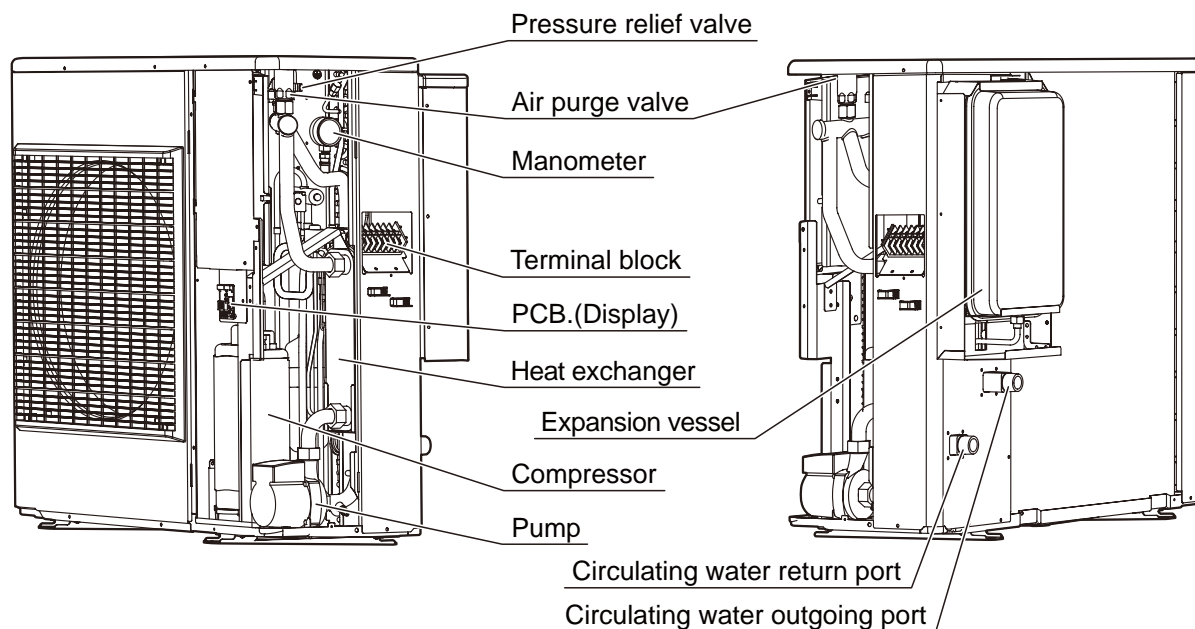

3-2. INSTALLATION PLACE

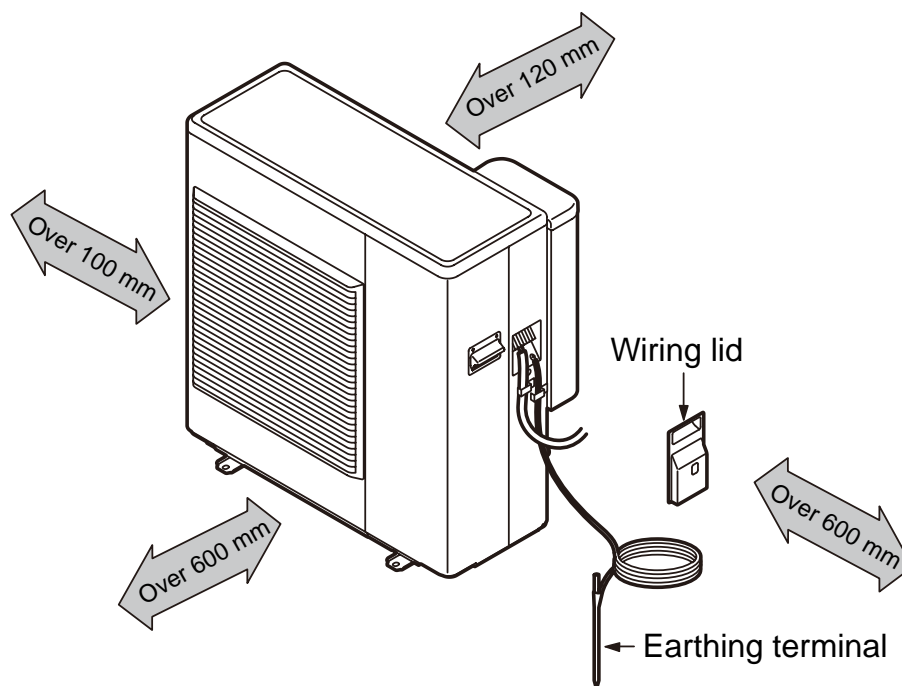

- Anchor the unit to the concrete or the block with bolts ($\varnothing 10$ mm) and nuts firmly and horizontally.
- In case the vibration may affect the house, use an anti-vibration gum and fix the Unit.

● Selecting the installation place

⚠ WARNING

Select installation locations that can properly support the weight of the units. Install the units securely so that they do not topple or fall.

⚠ CAUTION

- Do not install where there is the danger of combustible gas leakage.
- Do not install the unit near heat source of heat, steam, or flammable gas.
- If children under 10 years old may approach the unit, take preventive measures so that they cannot reach the unit.

⚠ WARNING

When installing the outdoor unit where it may be exposed to strong wind, fasten it securely.

Decide the mounting position with the customer as follows:

- (1) Install the unit in a location which can withstand the weight of the unit and vibration, and which can install horizontally.
- (2) Provide the indicated space to ensure good airflow.
- (3) If possible, do not install the unit where it will be exposed to direct sunlight.
(If necessary, install a blind that does not interfere with the airflow.)
- (4) Do not install the unit near a source of heat, steam, or flammable gas.
- (5) During heating operation, drain water flows from the outdoor unit. Therefore, install the outdoor unit in a place where the drain water flow will not be obstructed.
(Reverse cycle model only)
- (6) Do not install the unit where strong wind blows or where it is very dusty.
- (7) Do not install the unit where people pass.
- (8) Install the unit in a place where it will be free from being dirty or getting wet by rain as much as possible.

● Installation procedure

⚠ WARNING

- Install the unit where it will not be tilted by more than 5°.
- When installing the unit where it may be exposed to strong wind, fasten it securely.

⚠ CAUTION

- When the outdoor temperature is 0 °C or less, do not use drain pipe and drain cap.
If the drain pipe and drain cap are used, the drain water in the pipe may freeze in extremely cold weather.
- In the area with heavy snowfall, if the intake and outlet of unit is blocked with snow, it might become difficult to get warm and it is likely to cause of the breakdown.
Please construct a canopy and a pedestal or place the unit on a high stand (local configured).

4. PIPING DIAGRAM

■ MODELS : WP*A080L, WP*A100L

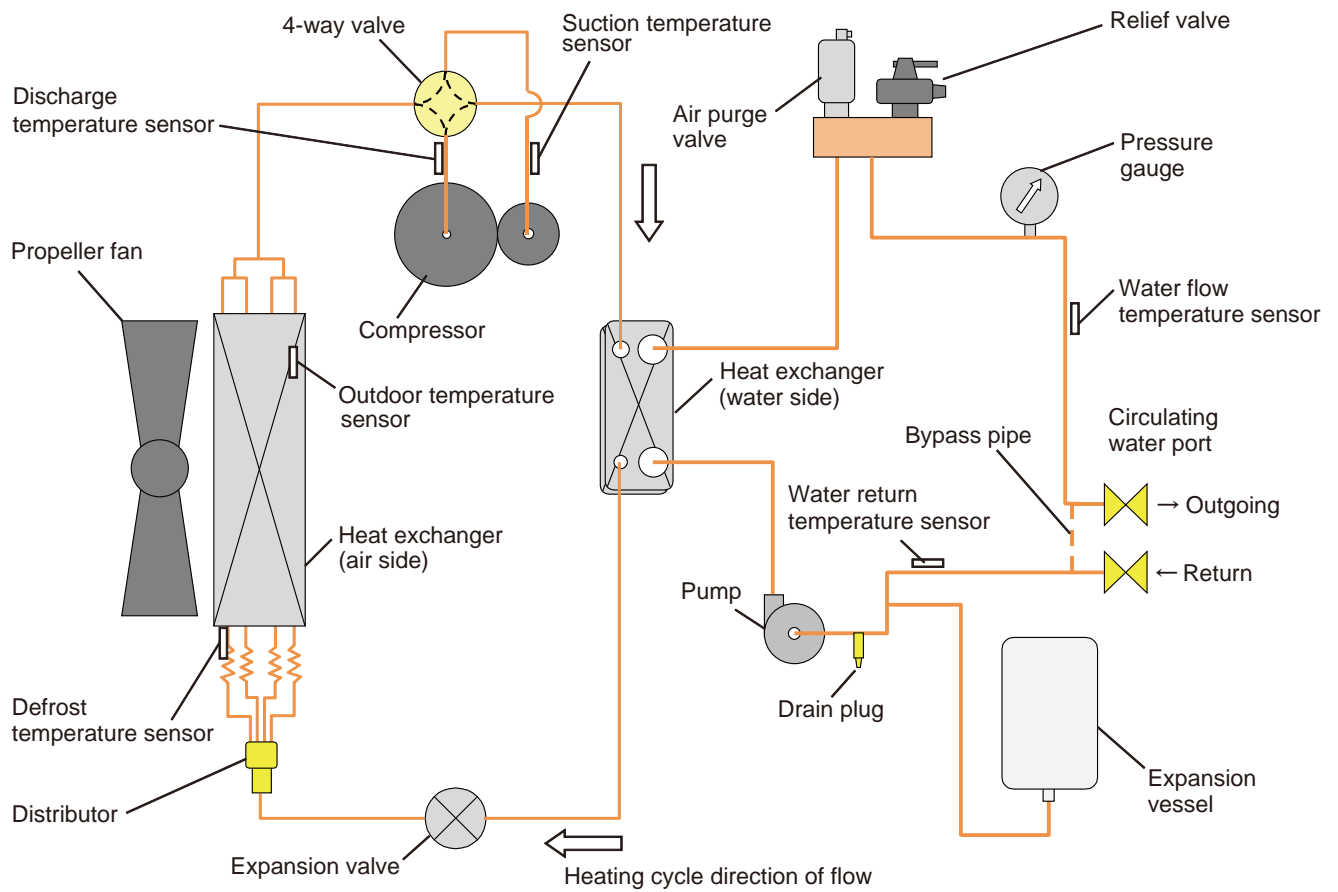

5. WIRING DIAGRAM

5-1. WIRING DIAGRAM

■ MODELS : WP*A080L, WP*A100L

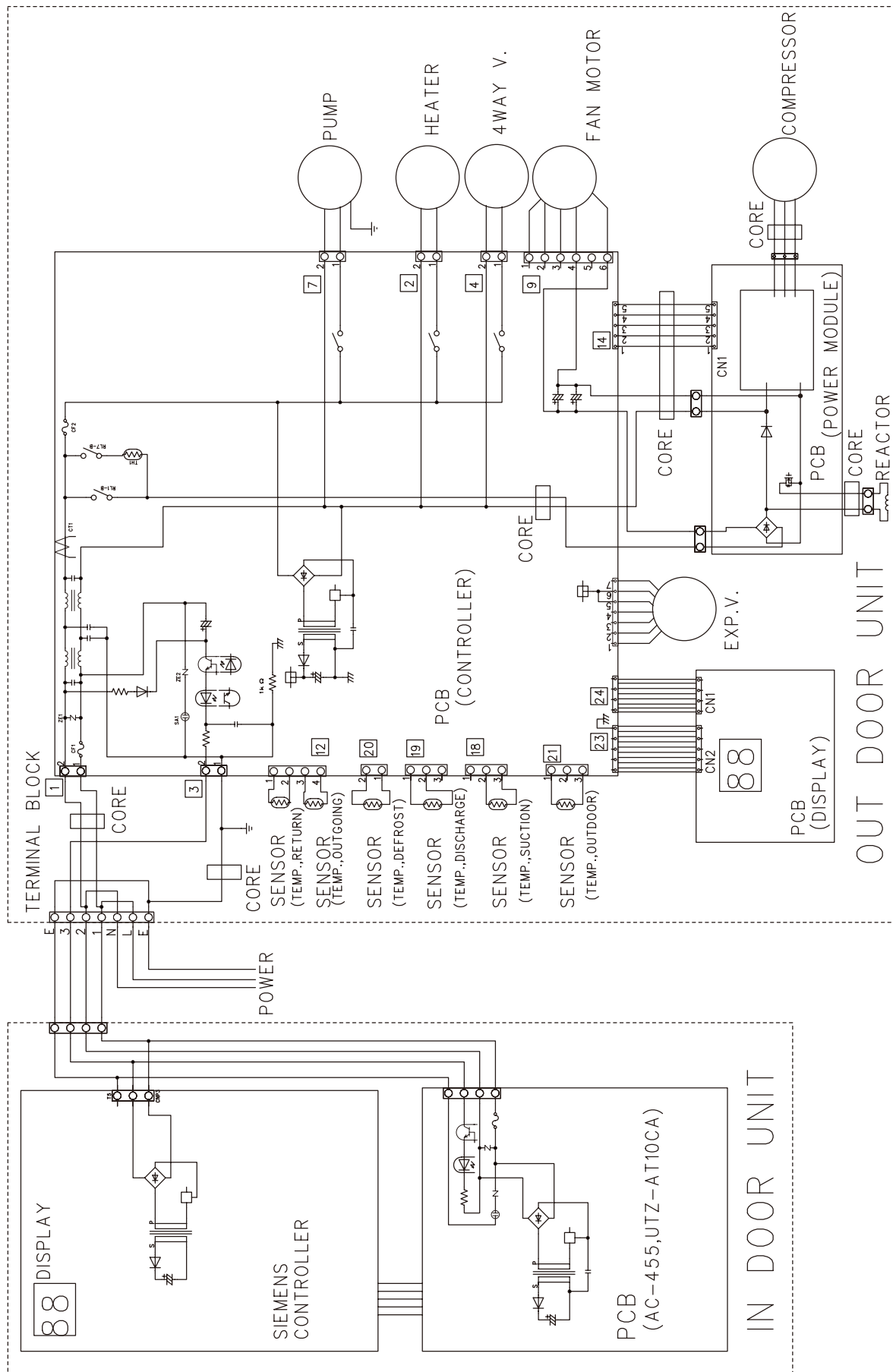

6. CAPACITY TABLES

6-1. HEATING CAPACITY

■ MODEL : WP*A080L

FT	30°C			35°C			40°C			45°C			50°C			55°C			
	OT	HC	IP	COP	HC	IP	COP	HC	IP	COP	HC	IP	COP	HC	IP	COP	HC	IP	COP
-20°C	5.49	2.75	2.00	5.20	2.89	1.80	4.75	2.94	1.62	4.30	2.98	1.44	3.80	2.97	1.28	3.30	2.95	1.12	
-19°C	5.68	2.79	2.04	5.38	2.90	1.86	4.91	2.94	1.67	4.44	2.98	1.49	3.92	2.97	1.32	3.40	2.95	1.15	
-18°C	5.87	2.84	2.07	5.56	2.92	1.90	5.07	2.94	1.72	4.58	2.97	1.54	4.04	2.96	1.36	3.50	2.95	1.19	
-17°C	6.07	2.88	2.11	5.74	2.93	1.96	5.23	2.95	1.77	4.72	2.96	1.59	4.16	2.96	1.41	3.60	2.95	1.22	
-16°C	6.26	2.93	2.14	5.92	2.95	2.01	5.39	2.95	1.83	4.86	2.95	1.65	4.28	2.95	1.45	3.70	2.95	1.25	
-15°C	6.45	2.97	2.17	6.10	2.96	2.06	5.55	2.95	1.88	5.00	2.94	1.70	4.40	2.95	1.49	3.80	2.95	1.29	
-14°C	6.56	2.96	2.22	6.23	2.96	2.10	5.71	2.95	1.94	5.19	2.95	1.76	4.56	2.95	1.55	3.93	2.95	1.33	
-13°C	6.68	2.96	2.26	6.35	2.95	2.15	5.86	2.95	1.99	5.38	2.95	1.82	4.71	2.96	1.59	4.05	2.95	1.37	
-12°C	6.79	2.95	2.30	6.48	2.95	2.20	6.02	2.95	2.04	5.56	2.96	1.88	4.87	2.96	1.65	4.18	2.95	1.42	
-11°C	6.90	2.94	2.35	6.60	2.95	2.24	6.18	2.96	2.09	5.75	2.96	1.94	5.03	2.96	1.70	4.30	2.95	1.46	
-10°C	7.01	2.93	2.39	6.73	2.94	2.29	6.33	2.96	2.14	5.94	2.97	2.00	5.18	2.96	1.75	4.43	2.95	1.50	
-9°C	7.13	2.93	2.43	6.85	2.94	2.33	6.49	2.96	2.19	6.13	2.97	2.06	5.34	2.97	1.80	4.55	2.95	1.54	
-8°C	7.24	2.92	2.48	6.98	2.93	2.38	6.64	2.96	2.24	6.31	2.98	2.12	5.49	2.97	1.85	4.68	2.95	1.59	
-7°C	7.35	2.91	2.53	7.10	2.93	2.42	6.80	2.96	2.30	6.50	2.98	2.18	5.65	2.97	1.90	4.80	2.95	1.63	
-6°C	7.38	2.87	2.57	7.13	2.88	2.48	6.83	2.91	2.35	6.53	2.93	2.23	5.68	2.92	1.95	4.84	2.88	1.68	
-5°C	7.42	2.83	2.62	7.17	2.83	2.53	6.86	2.86	2.40	6.56	2.88	2.28	5.70	2.87	1.99	4.88	2.82	1.73	
-4°C	7.45	2.79	2.67	7.20	2.78	2.59	6.90	2.81	2.46	6.59	2.83	2.33	5.73	2.82	2.03	4.91	2.75	1.79	
-3°C	7.48	2.75	2.72	7.23	2.73	2.65	6.93	2.76	2.51	6.62	2.78	2.38	5.76	2.77	2.08	4.95	2.68	1.85	
-2°C	7.48	2.75	2.72	7.27	2.73	2.66	7.00	2.75	2.55	6.74	2.76	2.44	5.94	2.78	2.14	5.20	2.73	1.90	
-1°C	7.49	2.75	2.72	7.30	2.73	2.67	7.08	2.74	2.58	6.85	2.75	2.49	6.13	2.79	2.20	5.45	2.79	1.95	
0°C	7.49	2.74	2.73	7.33	2.73	2.68	7.15	2.74	2.61	6.97	2.74	2.54	6.32	2.80	2.26	5.70	2.84	2.01	
1°C	7.50	2.74	2.74	7.37	2.73	2.70	7.23	2.73	2.65	7.08	2.72	2.60	6.51	2.82	2.31	5.95	2.90	2.05	
2°C	7.50	2.74	2.74	7.40	2.73	2.71	7.30	2.72	2.68	7.20	2.71	2.66	6.70	2.83	2.37	6.20	2.95	2.10	
3°C	7.70	2.60	2.96	7.60	2.63	2.89	7.50	2.69	2.79	7.40	2.72	2.72	7.03	2.82	2.49	6.63	2.95	2.25	
4°C	7.90	2.47	3.20	7.80	2.52	3.10	7.70	2.66	2.89	7.60	2.74	2.77	7.37	2.82	2.61	7.07	2.95	2.40	
5°C	8.10	2.33	3.48	8.00	2.42	3.31	7.90	2.63	3.00	7.80	2.75	2.84	7.70	2.81	2.74	7.50	2.95	2.54	
6°C	8.10	1.70	4.76	8.00	1.81	4.42	7.90	2.05	3.85	7.80	2.27	3.44	7.70	2.69	2.86	7.50	2.92	2.57	
7°C	8.10	1.67	4.85	8.00	1.78	4.50	7.90	2.01	3.93	7.80	2.23	3.50	7.70	2.56	3.01	7.50	2.89	2.60	
8°C	8.10	1.64	4.94	8.00	1.75	4.57	7.90	1.97	4.01	7.80	2.19	3.56	7.70	2.52	3.06	7.50	2.86	2.62	
9°C	8.10	1.61	5.03	8.00	1.71	4.68	7.90	1.94	4.07	7.80	2.16	3.61	7.70	2.49	3.09	7.50	2.83	2.65	
10°C	8.10	1.58	5.13	8.00	1.68	4.76	7.90	1.90	4.16	7.80	2.12	3.68	7.70	2.45	3.14	7.50	2.80	2.68	
11°C	8.10	1.55	5.23	8.00	1.64	4.88	7.90	1.86	4.25	7.80	2.07	3.77	7.70	2.40	3.21	7.50	2.76	2.72	
12°C	8.10	1.52	5.33	8.00	1.61	4.97	7.90	1.82	4.34	7.80	2.03	3.84	7.70	2.35	3.28	7.50	2.71	2.77	
13°C	8.10	1.48	5.47	8.00	1.57	5.10	7.90	1.78	4.44	7.80	1.98	3.94	7.70	2.29	3.36	7.50	2.67	2.81	
14°C	8.10	1.45	5.59	8.00	1.54	5.19	7.90	1.74	4.54	7.80	1.94	4.02	7.70	2.24	3.44	7.50	2.62	2.86	
15°C	8.10	1.42	5.70	8.00	1.50	5.33	7.90	1.70	4.65	7.80	1.89	4.13	7.70	2.19	3.52	7.50	2.58	2.91	
16°C	8.10	1.40	5.79	8.00	1.47	5.44	7.90	1.66	4.76	7.80	1.85	4.22	7.70	2.14	3.60	7.50	2.54	2.95	
17°C	8.10	1.37	5.91	8.00	1.44	5.56	7.90	1.63	4.85	7.80	1.81	4.31	7.70	2.10	3.67	7.50	2.50	3.00	
18°C	8.10	1.35	6.00	8.00	1.42	5.63	7.90	1.59	4.97	7.80	1.78	4.38	7.70	2.05	3.76	7.50	2.47	3.04	
19°C	8.10	1.32	6.14	8.00	1.39	5.76	7.90	1.56	5.06	7.80	1.74	4.48	7.70	2.01	3.83	7.50	2.43	3.09	
20°C	8.10	1.30	6.23	8.00	1.36	5.88	7.90	1.52	5.20	7.80	1.70	4.59	7.70	1.96	3.93	7.50	2.39	3.14	
21°C	8.10	1.28	6.33	8.00	1.34	5.97	7.90	1.49	5.30	7.80	1.67	4.67	7.70	1.93	3.99	7.50	2.35	3.19	
22°C	8.10	1.25	6.48	8.00	1.31	6.11	7.90	1.47	5.37	7.80	1.64	4.76	7.70	1.89	4.07	7.50	2.31	3.25	
23°C	8.10	1.23	6.59	8.00	1.29	6.20	7.90	1.44	5.49	7.80	1.61	4.84	7.70	1.86	4.14	7.50	2.27	3.30	
24°C	8.10	1.20	6.75	8.00	1.26	6.35	7.90	1.41	5.60	7.80	1.58	4.94	7.70	1.82	4.23	7.50	2.22	3.38	
25°C	8.10	1.18	6.86	8.00	1.24	6.45	7.90	1.38	5.72	7.80	1.55	5.03	7.70	1.79	4.30	7.50	2.18	3.44	
26°C	8.10	1.16	6.98	8.00	1.21	6.61	7.90	1.36	5.81	7.80	1.52	5.13	7.70	1.75	4.40	7.50	2.14	3.50	
27°C	8.10	1.13	7.17	8.00	1.19	6.72	7.90	1.33	5.94	7.80	1.49	5.23	7.70	1.72	4.48	7.50	2.10	3.57	
28°C	8.10	1.11	7.30	8.00	1.16	6.90	7.90	1.30	6.08	7.80	1.45	5.38	7.70	1.68	4.58	7.50	2.06	3.64	
29°C	8.10	1.08	7.50	8.00	1.14	7.02	7.90	1.27	6.22	7.80	1.42	5.49	7.70	1.65	4.67	7.50	2.02	3.71	
30°C	8.10	1.06	7.64	8.00	1.11	7.21	7.90	1.25	6.32	7.80	1.39	5.61	7.70	1.61	4.78	7.50	1.98	3.79	
31°C	8.10	1.04	7.79	8.00	1.09	7.34	7.90	1.22	6.48	7.80	1.36	5.74	7.70	1.58	4.87	7.50	1.94	3.87	
32°C	8.10	1.01	8.02	8.00	1.06	7.55	7.90	1.19	6.64	7.80	1.33	5.86	7.70	1.54	5.00	7.50	1.89	3.97	
33°C	8.10	0.99	8.18	8.00	1.04	7.69	7.90	1.16	6.81	7.80	1.30	6.00	7.70	1.51	5.10	7.50	1.85	4.05	
34°C	8.10	0.96	8.44	8.00	1.01	7.92	7.90	1.14	6.93	7.80	1.27	6.14	7.70	1.47	5.24	7.50	1.81	4.14	
35°C	8.10	0.94	8.62	8.00	0.99	8.08	7.90	1.11	7.12	7.80	1.24	6.29	7.70	1.44	5.35	7.50	1.77	4.24	

FT : Flow temperature
 OT : Outdoor temperature
 HC : Heating capacity (kW)
 IP : Input power (kW)
 COP : Coefficient of performance

The values of heating capacity/power input/COP are based on measurement of EN14511 standard;
 FT < 45°C : The flow rate obtained during the test at the standard rating conditions of OT 7°C and Water temp. flow/return 35°C / 30°C, 1386l/h
 FT ≥ 45°C : The flow rate obtained during the test at the standard rating conditions of OT 35°C and Water temp. flow/return 45°C / 40°C, 1357l/h
 FT ≥ 55°C : The flow rate obtained during the test at the standard rating conditions of OT 35°C and Water temp. flow/return 55°C / 47°C, 819l/h

Usage environment, such as operation of the heating equipment, room temperature, and controller adjustments, may cause disparities between practically determined and measured values.

MODEL: WP*A100L

FT	30°C			35°C			40°C			45°C			50°C			55°C		
OT	HC	IP	COP	HC	IP	COP	HC	IP	COP	HC	IP	COP	HC	IP	COP	HC	IP	COP
-20°C	5.55	2.81	1.98	5.30	2.96	1.79	4.95	3.12	1.59	4.60	3.27	1.41	4.35	3.36	1.29	4.10	3.44	1.19
-19°C	5.79	2.89	2.00	5.52	3.02	1.83	5.15	3.15	1.63	4.78	3.28	1.46	4.49	3.35	1.34	4.20	3.42	1.23
-18°C	6.02	2.98	2.02	5.74	3.08	1.86	5.35	3.19	1.68	4.96	3.29	1.51	4.63	3.35	1.38	4.30	3.40	1.26
-17°C	6.26	3.06	2.05	5.96	3.14	1.90	5.55	3.22	1.72	5.14	3.30	1.56	4.77	3.34	1.43	4.40	3.37	1.31
-16°C	6.49	3.15	2.06	6.18	3.20	1.93	5.75	3.26	1.76	5.32	3.31	1.61	4.91	3.34	1.47	4.50	3.35	1.34
-15°C	6.73	3.23	2.08	6.40	3.26	1.96	5.95	3.29	1.81	5.50	3.32	1.66	5.05	3.33	1.52	4.60	3.33	1.38
-14°C	6.92	3.24	2.14	6.60	3.27	2.02	6.14	3.29	1.87	5.69	3.32	1.71	5.22	3.33	1.57	4.75	3.33	1.43
-13°C	7.12	3.26	2.18	6.80	3.28	2.07	6.34	3.30	1.92	5.88	3.32	1.77	5.39	3.33	1.62	4.90	3.34	1.47
-12°C	7.31	3.27	2.24	7.00	3.28	2.13	6.53	3.30	1.98	6.06	3.32	1.83	5.56	3.33	1.67	5.05	3.34	1.51
-11°C	7.51	3.28	2.29	7.20	3.29	2.19	6.73	3.31	2.03	6.25	3.32	1.88	5.73	3.33	1.72	5.20	3.34	1.56
-10°C	7.70	3.29	2.34	7.40	3.30	2.24	6.92	3.31	2.09	6.44	3.31	1.95	5.89	3.33	1.77	5.35	3.34	1.60
-9°C	7.89	3.31	2.38	7.60	3.31	2.30	7.11	3.31	2.15	6.63	3.31	2.00	6.06	3.33	1.82	5.50	3.35	1.64
-8°C	8.09	3.32	2.44	7.80	3.31	2.36	7.31	3.32	2.20	6.81	3.31	2.06	6.23	3.33	1.87	5.65	3.35	1.69
-7°C	8.28	3.33	2.49	8.00	3.32	2.41	7.50	3.32	2.26	7.00	3.31	2.11	6.40	3.33	1.92	5.80	3.35	1.73
-6°C	8.24	3.27	2.52	7.96	3.26	2.44	7.48	3.26	2.29	7.01	3.26	2.15	6.42	3.28	1.96	5.84	3.31	1.76
-5°C	8.20	3.20	2.56	7.92	3.20	2.48	7.45	3.21	2.32	7.01	3.21	2.18	6.43	3.24	1.98	5.88	3.27	1.80
-4°C	8.16	3.14	2.60	7.88	3.13	2.52	7.43	3.15	2.36	7.02	3.15	2.23	6.45	3.19	2.02	5.91	3.22	1.84
-3°C	8.11	3.08	2.64	7.84	3.07	2.55	7.40	3.09	2.39	7.02	3.10	2.26	6.46	3.14	2.06	5.95	3.18	1.87
-2°C	8.16	3.06	2.67	7.89	3.06	2.58	7.49	3.09	2.42	7.14	3.11	2.30	6.64	3.17	2.09	6.18	3.23	1.91
-1°C	8.21	3.04	2.70	7.94	3.04	2.61	7.58	3.08	2.46	7.25	3.12	2.32	6.82	3.20	2.13	6.41	3.28	1.95
0°C	8.26	3.03	2.73	8.00	3.03	2.64	7.67	3.08	2.49	7.37	3.12	2.36	6.99	3.23	2.16	6.64	3.34	1.99
1°C	8.30	3.01	2.76	8.05	3.01	2.67	7.76	3.07	2.53	7.48	3.13	2.39	7.17	3.26	2.20	6.87	3.39	2.03
2°C	8.35	2.99	2.79	8.10	3.00	2.70	7.85	3.07	2.56	7.60	3.14	2.42	7.35	3.29	2.23	7.10	3.44	2.06
3°C	8.93	3.00	2.98	8.73	3.04	2.87	8.53	3.17	2.69	8.33	3.27	2.55	8.07	3.39	2.38	7.63	3.49	2.19
4°C	9.52	3.00	3.17	9.37	3.08	3.04	9.22	3.28	2.81	9.07	3.41	2.66	8.78	3.48	2.52	8.15	3.53	2.31
5°C	10.10	3.01	3.36	10.00	3.12	3.21	9.90	3.38	2.93	9.80	3.54	2.77	9.50	3.58	2.65	8.68	3.58	2.42
6°C	10.10	2.18	4.63	10.00	2.33	4.29	9.90	2.63	3.76	9.80	2.91	3.37	9.50	3.41	2.79	8.79	3.51	2.50
7°C	10.10	2.15	4.70	10.00	2.30	4.35	9.90	2.59	3.82	9.80	2.88	3.40	9.50	3.23	2.94	8.90	3.44	2.59
8°C	10.10	2.12	4.76	10.00	2.27	4.41	9.90	2.55	3.88	9.80	2.85	3.44	9.50	3.18	2.99	8.90	3.40	2.62
9°C	10.10	2.08	4.86	10.00	2.23	4.48	9.90	2.52	3.93	9.80	2.81	3.49	9.50	3.14	3.03	8.90	3.36	2.65
10°C	10.10	2.05	4.93	10.00	2.20	4.55	9.90	2.48	3.99	9.80	2.78	3.53	9.50	3.09	3.07	8.90	3.32	2.68
11°C	10.10	2.01	5.02	10.00	2.15	4.65	9.90	2.43	4.07	9.80	2.72	3.60	9.50	3.03	3.14	8.90	3.27	2.72
12°C	10.10	1.97	5.13	10.00	2.11	4.74	9.90	2.37	4.18	9.80	2.66	3.68	9.50	2.96	3.21	8.90	3.22	2.76
13°C	10.10	1.93	5.23	10.00	2.06	4.85	9.90	2.32	4.27	9.80	2.60	3.77	9.50	2.90	3.28	8.90	3.18	2.80
14°C	10.10	1.89	5.34	10.00	2.02	4.95	9.90	2.26	4.38	9.80	2.54	3.86	9.50	2.83	3.36	8.90	3.13	2.84
15°C	10.10	1.85	5.46	10.00	1.97	5.08	9.90	2.21	4.48	9.80	2.48	3.95	9.50	2.77	3.43	8.90	3.08	2.89
16°C	10.10	1.81	5.58	10.00	1.93	5.18	9.90	2.16	4.58	9.80	2.42	4.05	9.50	2.71	3.51	8.90	3.04	2.93
17°C	10.10	1.77	5.71	10.00	1.88	5.32	9.90	2.11	4.69	9.80	2.37	4.14	9.50	2.65	3.58	8.90	3.00	2.97
18°C	10.10	1.74	5.80	10.00	1.84	5.43	9.90	2.06	4.81	9.80	2.31	4.24	9.50	2.60	3.65	8.90	2.96	3.01
19°C	10.10	1.70	5.94	10.00	1.79	5.59	9.90	2.01	4.93	9.80	2.26	4.34	9.50	2.54	3.74	8.90	2.92	3.05
20°C	10.10	1.66	6.08	10.00	1.75	5.71	9.90	1.96	5.05	9.80	2.20	4.45	9.50	2.48	3.83	8.90	2.88	3.09
21°C	10.10	1.63	6.20	10.00	1.72	5.81	9.90	1.92	5.16	9.80	2.16	4.54	9.50	2.44	3.89	8.90	2.83	3.14
22°C	10.10	1.60	6.31	10.00	1.69	5.92	9.90	1.89	5.24	9.80	2.12	4.62	9.50	2.39	3.97	8.90	2.79	3.19
23°C	10.10	1.57	6.43	10.00	1.65	6.06	9.90	1.85	5.35	9.80	2.08	4.71	9.50	2.35	4.04	8.90	2.74	3.25
24°C	10.10	1.54	6.56	10.00	1.62	6.17	9.90	1.82	5.44	9.80	2.04	4.80	9.50	2.31	4.11	8.90	2.69	3.31
25°C	10.10	1.51	6.69	10.00	1.59	6.29	9.90	1.78	5.56	9.80	2.00	4.90	9.50	2.26	4.20	8.90	2.64	3.37
26°C	10.10	1.48	6.82	10.00	1.56	6.41	9.90	1.74	5.69	9.80	1.96	5.00	9.50	2.22	4.28	8.90	2.60	3.42
27°C	10.10	1.45	6.97	10.00	1.53	6.54	9.90	1.71	5.79	9.80	1.92	5.10	9.50	2.18	4.36	8.90	2.55	3.49
28°C	10.10	1.41	7.16	10.00	1.49	6.71	9.90	1.67	5.93	9.80	1.88	5.21	9.50	2.13	4.46	8.90	2.50	3.56
29°C	10.10	1.38	7.32	10.00	1.46	6.85	9.90	1.64	6.04	9.80	1.84	5.33	9.50	2.09	4.55	8.90	2.45	3.63
30°C	10.10	1.35	7.48	10.00	1.43	6.99	9.90	1.60	6.19	9.80	1.80	5.44	9.50	2.05	4.63	8.90	2.41	3.69
31°C	10.10	1.32	7.65	10.00	1.40	7.14	9.90	1.56	6.35	9.80	1.76	5.57	9.50	2.00	4.75	8.90	2.36	3.77
32°C	10.10	1.29	7.83	10.00	1.37	7.30	9.90	1.53	6.47	9.80	1.72	5.70	9.50	1.96	4.85	8.90	2.31	3.85
33°C	10.10	1.26	8.02	10.00	1.33	7.52	9.90	1.49	6.64	9.80	1.68	5.83	9.50	1.92	4.95	8.90	2.26	3.94
34°C	10.10	1.23	8.21	10.00	1.30	7.69	9.90	1.46	6.78	9.80	1.64	5.98	9.50	1.87	5.08	8.90	2.22	4.01
35°C	10.10	1.20	8.42	10.00	1.27	7.87	9.90	1.42	6.97	9.80	1.60	6.13	9.50	1.83	5.19	8.90	2.17	4.10

FT : Flow temperature
 OT : Outdoor temperature
 HC : Heating capacity (kW)
 IP : Input power (kW)
 COP : Coefficient of performance

The values of heating capacity/power input/COP are based on measurement of EN14511 standard;
 FT < 45°C : The flow rate obtained during the test at the standard rating conditions of OT 7°C and Water temp. flow/return 35°C / 30°C, 1733l/h
 FT ≥ 45°C : The flow rate obtained during the test at the standard rating conditions of OT 35°C and Water temp. flow/return 45°C / 40°C, 1705l/h
 FT ≥ 55°C : The flow rate obtained during the test at the standard rating conditions of OT 35°C and Water temp. flow/return 55°C / 47°C, 972l/h

Usage environment, such as operation of the heating equipment, room temperature, and controller adjustments, may cause disparities between practically determined and measured values.

6-2. COOLING CAPACITY

■ MODEL : WP*A080L

FT	6 °C			7 °C			10 °C			13 °C			15 °C			18 °C			22 °C		
	OT	CC	IP	EER	CC	IP	EER	CC	IP	EER	CC	IP	EER	CC	IP	EER	CC	IP	EER	CC	IP
20 °C	4.33	0.96	4.51	4.50	0.95	4.75	5.01	0.89	5.64	5.53	0.83	6.67	5.88	0.84	6.99	6.40	0.86	7.47	7.09	0.88	8.08
21 °C	4.33	1.00	4.33	4.50	0.99	4.55	5.01	0.93	5.39	5.53	0.88	6.28	5.88	0.89	6.61	6.40	0.91	7.03	7.09	0.93	7.62
22 °C	4.33	1.04	4.16	4.50	1.02	4.41	5.01	0.98	5.11	5.53	0.93	5.95	5.88	0.94	6.26	6.40	0.96	6.67	7.09	0.98	7.23
23 °C	4.33	1.08	4.01	4.50	1.06	4.25	5.01	1.03	4.86	5.53	0.99	5.59	5.88	1.00	5.88	6.40	1.01	6.34	7.09	1.03	6.88
24 °C	4.33	1.12	3.87	4.50	1.11	4.05	5.01	1.08	4.64	5.53	1.04	5.32	5.88	1.05	5.60	6.40	1.06	6.04	7.09	1.09	6.50
25 °C	4.33	1.16	3.73	4.50	1.15	3.91	5.01	1.13	4.43	5.53	1.10	5.03	5.88	1.11	5.30	6.40	1.12	5.71	7.09	1.14	6.22
26 °C	4.33	1.21	3.58	4.50	1.20	3.75	5.01	1.19	4.21	5.53	1.17	4.73	5.88	1.18	4.98	6.40	1.18	5.42	7.09	1.21	5.86
27 °C	4.33	1.27	3.41	4.50	1.26	3.57	5.01	1.25	4.01	5.53	1.24	4.46	5.88	1.25	4.70	6.40	1.25	5.12	7.09	1.28	5.54
28 °C	4.33	1.33	3.26	4.50	1.32	3.41	5.01	1.32	3.80	5.53	1.30	4.25	5.88	1.31	4.49	6.40	1.32	4.85	7.09	1.34	5.29
29 °C	4.33	1.39	3.12	4.50	1.38	3.26	5.01	1.38	3.63	5.53	1.37	4.04	5.88	1.38	4.26	6.40	1.39	4.60	7.09	1.41	5.03
30 °C	4.33	1.45	2.99	4.50	1.45	3.10	5.01	1.45	3.46	5.53	1.44	3.84	5.88	1.45	4.06	6.40	1.46	4.38	7.09	1.48	4.79
31 °C	4.33	1.51	2.87	4.50	1.51	2.98	5.01	1.51	3.32	5.53	1.52	3.64	5.88	1.52	3.87	6.40	1.53	4.18	7.09	1.56	4.54
32 °C	4.33	1.58	2.74	4.50	1.58	2.85	5.01	1.58	3.17	5.53	1.59	3.48	5.88	1.60	3.68	6.40	1.61	3.98	7.09	1.63	4.35
33 °C	4.33	1.65	2.62	4.50	1.65	2.73	5.01	1.66	3.02	5.53	1.67	3.31	5.88	1.68	3.50	6.40	1.69	3.79	7.09	1.71	4.15
34 °C	4.33	1.73	2.50	4.50	1.73	2.60	5.01	1.74	2.87	5.53	1.76	3.14	5.88	1.77	3.33	6.40	1.78	3.60	7.09	1.80	3.94
35 °C	4.33	1.88	2.30	4.50	1.86	2.42	5.01	1.83	2.74	5.53	1.81	3.06	5.88	1.81	3.25	6.40	1.82	3.52	7.09	1.85	3.83
36 °C	4.33	2.04	2.12	4.50	2.01	2.24	5.01	1.92	2.61	5.53	1.85	2.99	5.88	1.85	3.18	6.40	1.86	3.44	7.09	1.89	3.75
37 °C	4.33	2.22	1.95	4.50	2.17	2.07	5.01	2.03	2.47	5.53	1.91	2.90	5.88	1.90	3.09	6.40	1.91	3.35	7.09	1.95	3.64
38 °C	4.16	2.29	1.82	4.34	2.24	1.94	4.86	2.10	2.31	5.40	1.98	2.73	5.77	1.98	2.91	6.32	1.99	3.18	7.05	2.03	3.47
39 °C	4.00	2.37	1.69	4.18	2.32	1.80	4.72	2.18	2.17	5.26	2.05	2.57	5.66	2.05	2.76	6.24	2.07	3.01	7.02	2.11	3.33
40 °C	3.83	2.44	1.57	4.02	2.39	1.68	4.57	2.25	2.03	5.13	2.12	2.42	5.54	2.13	2.60	6.16	2.15	2.87	6.98	2.20	3.17
41 °C	3.67	2.52	1.46	3.86	2.47	1.56	4.43	2.33	1.90	5.00	2.19	2.28	5.43	2.21	2.46	6.08	2.23	2.73	6.94	2.28	3.04
42 °C	3.50	2.59	1.35	3.70	2.54	1.45	4.28	2.40	1.78	4.87	2.26	2.15	5.32	2.28	2.33	6.00	2.32	2.59	6.91	2.36	2.93
43 °C	2.36	1.32	1.79	2.47	1.33	1.86	2.81	1.33	2.12	3.19	1.31	2.43	3.39	1.32	2.57	3.73	1.32	2.83	4.19	1.32	3.18

FT : Flow temperature
 OT : Outdoor temperature
 CC : Cooling capacity (kW)
 IP : Input power (kW)
 EER : Energy efficiency ratio

The values of cooling capacity/power input/EER are based on measurement of EN14511 standard.

FT < 10 °C : The flow rate obtained during the test at the standard rating conditions of OT 35°C and Water temp. flow/return 7°C / 12°C, 774l/h

FT ≥ 10 °C : The flow rate obtained during the test at the standard rating conditions of OT 35°C and Water temp. flow/return 18°C / 23°C, 1100l/h

Usage environment, such as operation of the heating equipment, room temperature, and controller adjustments, may cause disparities between practically determined and measured values.

■ MODEL: WP*A100L

FT	6 °C			7 °C			10 °C			13 °C			15 °C			18 °C			22 °C		
	OT	CC	IP	EER	CC	IP	EER	CC	IP	EER	CC	IP	EER	CC	IP	EER	CC	IP	EER	CC	IP
20 °C	4.81	1.09	4.43	5.00	1.07	4.68	5.57	1.02	5.48	6.14	0.96	6.38	6.53	0.96	6.79	7.10	0.96	7.39	7.86	1.00	7.86
21 °C	4.81	1.13	4.26	5.00	1.11	4.50	5.57	1.07	5.21	6.14	1.02	6.02	6.53	1.02	6.40	7.10	1.02	6.96	7.86	1.06	7.42
22 °C	4.81	1.17	4.11	5.00	1.15	4.35	5.57	1.12	4.97	6.14	1.07	5.74	6.53	1.08	6.05	7.10	1.08	6.57	7.86	1.12	7.02
23 °C	4.81	1.21	3.98	5.00	1.20	4.17	5.57	1.17	4.76	6.14	1.13	5.43	6.53	1.13	5.78	7.10	1.14	6.23	7.86	1.18	6.66
24 °C	4.81	1.25	3.85	5.00	1.24	4.03	5.57	1.22	4.57	6.14	1.19	5.16	6.53	1.20	5.44	7.10	1.21	5.87	7.86	1.24	6.34
25 °C	4.81	1.30	3.70	5.00	1.29	3.88	5.57	1.28	4.35	6.14	1.25	4.91	6.53	1.26	5.18	7.10	1.27	5.59	7.86	1.31	6.00
26 °C	4.81	1.35	3.56	5.00	1.35	3.72	5.57	1.34	4.16	6.14	1.33	4.63	6.53	1.34	4.89	7.10	1.35	5.26	7.86	1.39	5.65
27 °C	4.81	1.42	3.39	5.00	1.41	3.55	5.57	1.41	3.95	6.14	1.40	4.39	6.53	1.41	4.63	7.10	1.43	4.97	7.86	1.47	5.35
28 °C	4.81	1.48	3.25	5.00	1.48	3.38	5.57	1.49	3.74	6.14	1.48	4.15	6.53	1.49	4.38	7.10	1.51	4.70	7.86	1.55	5.07
29 °C	4.81	1.55	3.10	5.00	1.55	3.23	5.57	1.56	3.57	6.14	1.56	3.94	6.53	1.57	4.16	7.10	1.59	4.47	7.86	1.63	4.82
30 °C	4.81	1.62	2.97	5.00	1.63	3.07	5.57	1.64	3.40	6.14	1.64	3.74	6.53	1.66	3.93	7.10	1.68	4.23	7.86	1.72	4.57
31 °C	4.81	1.70	2.83	5.00	1.70	2.94	5.57	1.72	3.24	6.14	1.73	3.55	6.53	1.74	3.75	7.10	1.77	4.01	7.86	1.81	4.34
32 °C	4.81	1.77	2.72	5.00	1.78	2.81	5.57	1.80	3.09	6.14	1.81	3.39	6.53	1.83	3.57	7.10	1.86	3.82	7.86	1.90	4.14
33 °C	4.81	1.85	2.60	5.00	1.86	2.69	5.57	1.88	2.96	6.14	1.90	3.23	6.53	1.92	3.40	7.10	1.95	3.64	7.86	1.99	3.95
34 °C	4.81	1.94	2.48	5.00	1.95	2.56	5.57	1.98	2.81	6.14	2.01	3.05	6.53	2.03	3.22	7.10	2.06	3.45	7.86	2.10	3.74
35 °C	4.81	2.11	2.28	5.00	2.10	2.38	5.57	2.08	2.68	6.14	2.05	3.00	6.53	2.07	3.15	7.10	2.10	3.38	7.86	2.15	3.66
36 °C	4.81	2.29	2.10	5.00	2.26	2.21	5.57	2.18	2.56	6.14	2.10	2.92	6.53	2.11	3.09	7.10	2.14	3.32	7.86	2.19	3.59
37 °C	4.81	2.49	1.93	5.00	2.45	2.04	5.57	2.30	2.42	6.14	2.15	2.86	6.53	2.16	3.02	7.10	2.18	3.26	7.86	2.25	3.49
38 °C	4.55	2.51	1.81	4.74	2.47	1.92	5.31	2.32	2.29	5.89	2.17	2.71	6.29	2.18	2.89	6.88	2.21	3.11	7.67	2.27	3.38
39 °C	4.29	2.53	1.70	4.48	2.49	1.80	5.05	2.34	2.16	5.63	2.19	2.57	6.05	2.21	2.74	6.66	2.23	2.99	7.48	2.29	3.27
40 °C	4.03	2.55	1.58	4.22	2.51	1.68	4.80	2.36	2.03	5.38	2.22	2.42	5.80	2.23	2.60	6.44	2.26	2.85	7.29	2.32	3.14
41 °C	3.76	2.57	1.46	3.96	2.52	1.57	4.54	2.38	1.91	5.12	2.24	2.29	5.56	2.26	2.46	6.22	2.29	2.72	7.10	2.34	3.03
42 °C	3.50	2.59	1.35	3.70	2.54	1.45	4.28	2.40	1.78	4.87	2.26	2.15	5.32	2.28	2.33	6.00	2.32	2.59	6.91	2.36	2.93
43 °C	2.36	1.32	1.79	2.47	1.33	1.86	2.81	1.33	2.12	3.19	1.31	2.43	3.39	1.32	2.57	3.73	1.32	2.83	4.19	1.32	3.18

FT : Flow temperature
 OT : Outdoor temperature
 CC : Cooling capacity (kW)
 IP : Input power (kW)
 EER : Energy efficiency ratio

The values of cooling capacity/power input/EER are based on measurement of EN14511 standard.

FT < 10 °C : The flow rate obtained during the test at the standard rating conditions of OT 35°C and Water temp. flow/return 7°C / 12°C, 860l/h

FT ≥ 10 °C : The flow rate obtained during the test at the standard rating conditions of OT 35°C and Water temp. flow/return 18°C / 23°C, 1221l/h

Usage environment, such as operation of the heating equipment, room temperature, and controller adjustments, may cause disparities between practically determined and measured values.

7. OPERATION NOISE

7-1. NOISE LEVEL CURVE

■ MODEL: WP*A080L, WP*A100L

● Heating

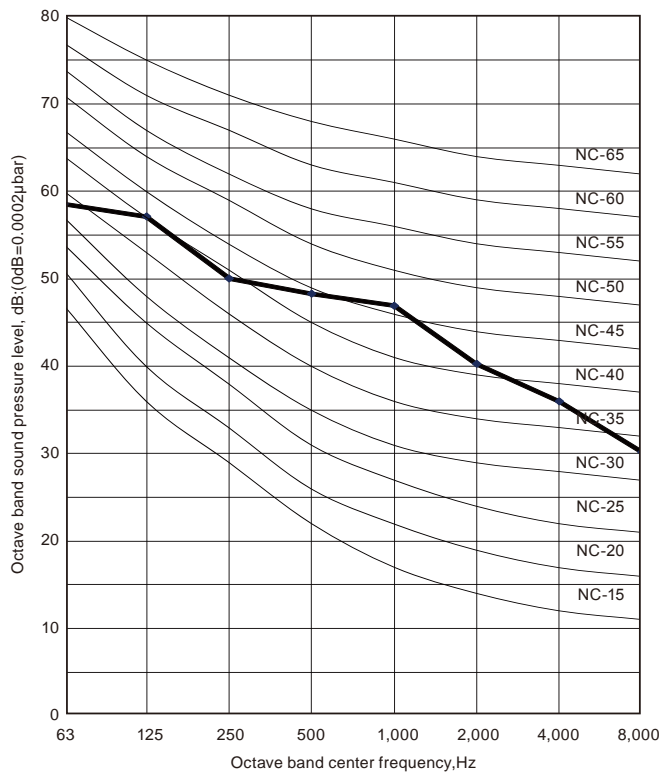

7-2. SOUND LEVEL CHECK POINT

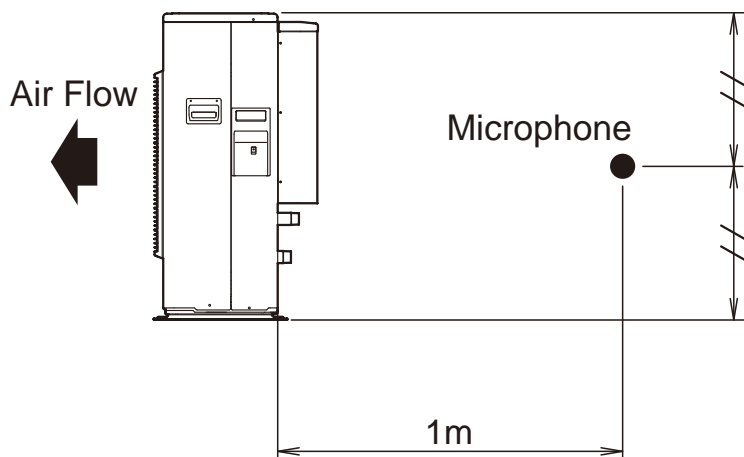

8. OPERATION RANGE

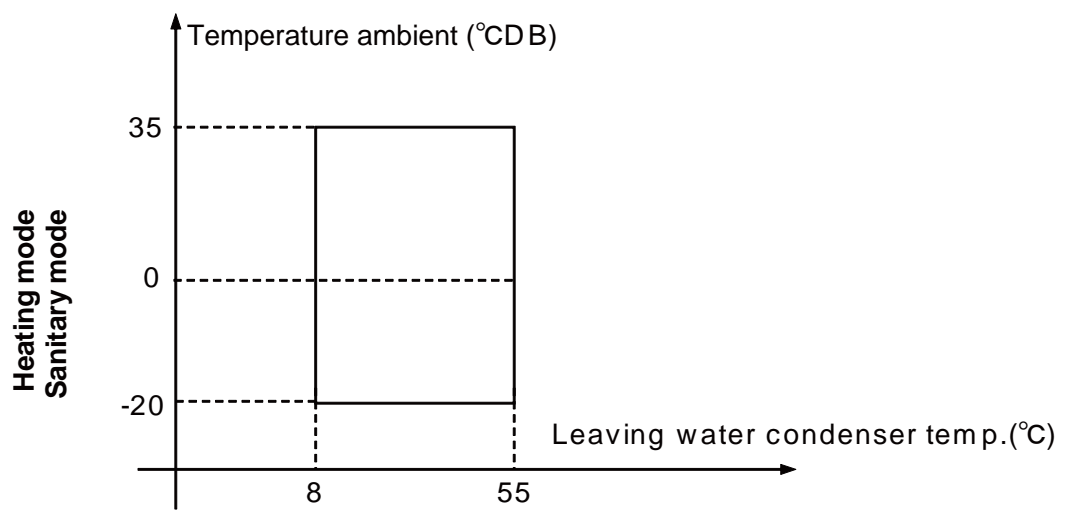
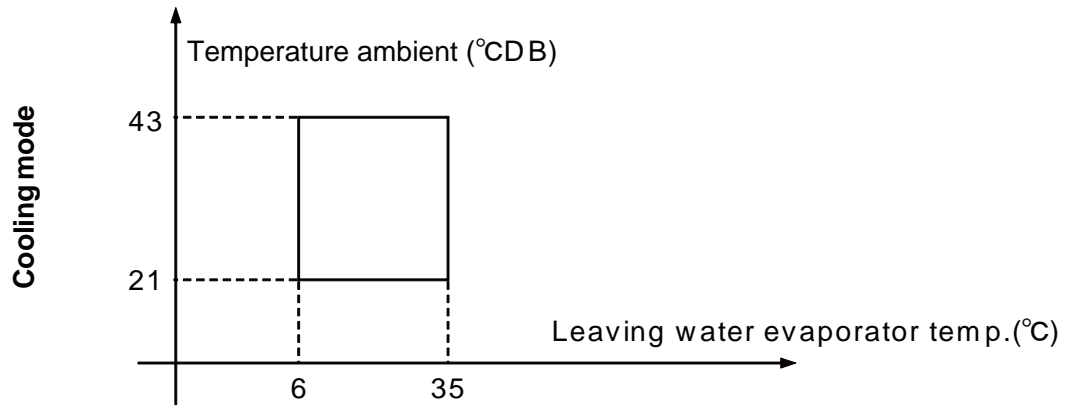

9. HYDRAULIC PERFORMANCE

9-1. STATIC PRESSURE DROP UNIT

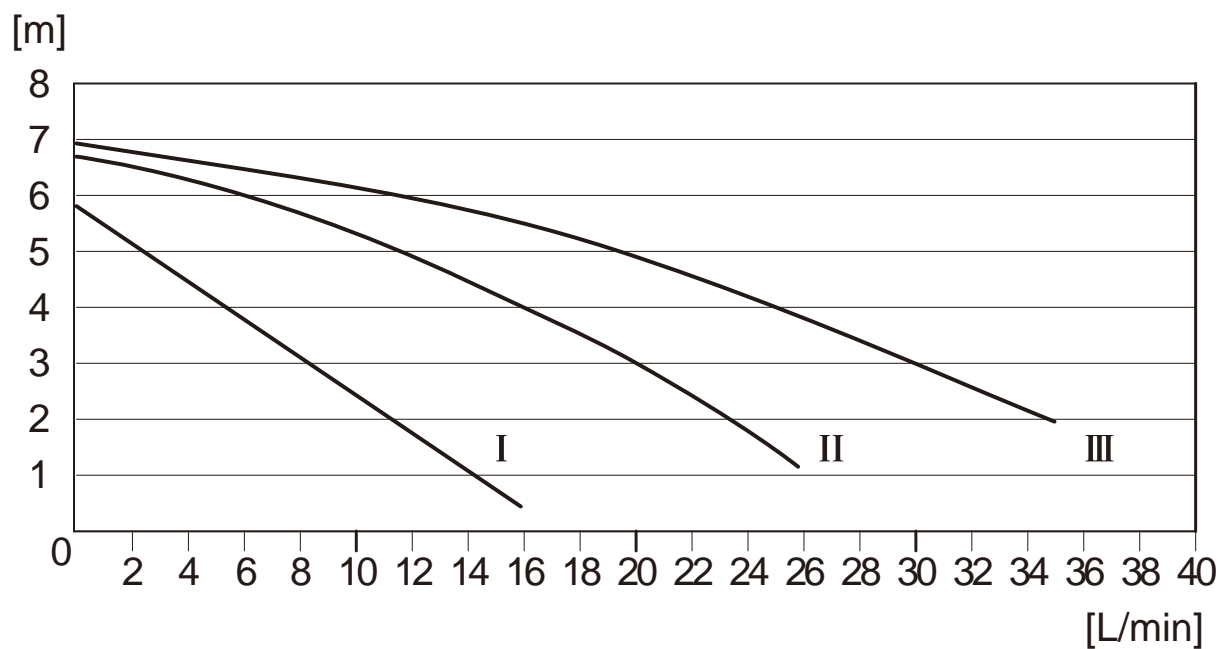



- I : Pump speed-1 (Low)
- II : Pump speed-2 (Middle)
- III : Pump speed-3 (High)

10. SAFETY DEVICES

	Protection form	Model	
		WP*A080L	WP*A100L
Circuit protection	Current fuse (Main PCB)	5A 250V	
		3.15A 250V	
		25A 250V (No replacement) 15A 250V (No replacement)	
Fan motor protection	Thermal protector	OFF: 150 °C ON: 120 °C	
Compressor protection	Thermal protection program (Discharge temperature)	OFF: 115 °C ON: 90 °C	
High pressure protection	Thermal protection program (Water flow temperature)	OFF: 57 °C ON: 54 °C	

11. STANDARD ACCESSORIES

Name and shape	Q'ty	Application
Installation manual 	1	
Specification sheet 	1	

WATERSTAGE™

2. CONTROL SYSTEM

UTW-SCB*A

CONTENTS

2. CONTROL SYSTEM

1. FEATURES	CS01 - 01
2. FUNCTIONS	CS01 - 03
2-1. USER INTERFACE (Control box) AND REMOTE CONTROL (Optional parts).....	CS01 - 03
2-2. ROOM THERMOSTAT (Optional parts)	CS01 - 07
2-3. CONTROL SETTING	CS01 - 08
3. ELECTRICAL CONNECTIONS	CS01 - 64
3-1. OVERVIEW OF ALL THE ELECTRICAL CONNECTIONS	CS01 - 64
3-2. ELECTRICAL CONNECTIONS ON THE CONTROL BOX	CS01 - 65
3-3. CONNECTIONS TO THE HEAT PUMP REGULATOR (Accessories and options)	CS01 - 67
4. INSTALLATION	CS01 - 69
4-1. CONTROL BOX	CS01 - 69
4-2. OUTDOOR SENSOR.....	CS01 - 70
4-3. REMOTE CONTROL (Optional parts)	CS01 - 71
4-4. ROOM THERMOSTAT (Optional parts)	CS01 - 73
5. DIMENSIONS	CS01 - 75
5-1. CONTROL BOX	CS01 - 75
5-2. OUTDOOR SENSOR.....	CS01 - 76
5-3. REMOTE CONTROL (Optional parts)	CS01 - 77
5-4. ROOM THERMOSTAT (Optional parts)	CS01 - 78
6. PACKING LIST (Accessories)	CS01 - 79
6-1. CONTROL BOX	CS01 - 79
6-2. REMOTE CONTROL (Optional parts)	CS01 - 79
6-3. ROOM THERMOSTAT (Optional parts)	CS01 - 79
7. WIRING SPECIFICATIONS	CS01 - 80
7-1. CONTROL BOX	CS01 - 80
7-2. OUTDOOR SENSOR.....	CS01 - 80
7-3. REMOTE CONTROL (Optional parts)	CS01 - 80
7-4. ROOM THERMOSTAT (Optional parts)	CS01 - 80
8. SPECIFICATIONS	CS01 - 81
8-1. CONTROL BOX	CS01 - 81
8-2. OUTDOOR SENSOR.....	CS01 - 81
8-3. REMOTE CONTROL (Optional parts)	CS01 - 81
8-4. ROOM THERMOSTAT (Optional parts)	CS01 - 81

1. FEATURES

● Smart & comfort control

The outdoor temperature is detected by sensor and the heating water temperature is controlled automatically.

The setting of room temperature and operation mode can be easily set. A wide range of control from heating to hot water supply and swimming pool is possible by combining with various optional parts.

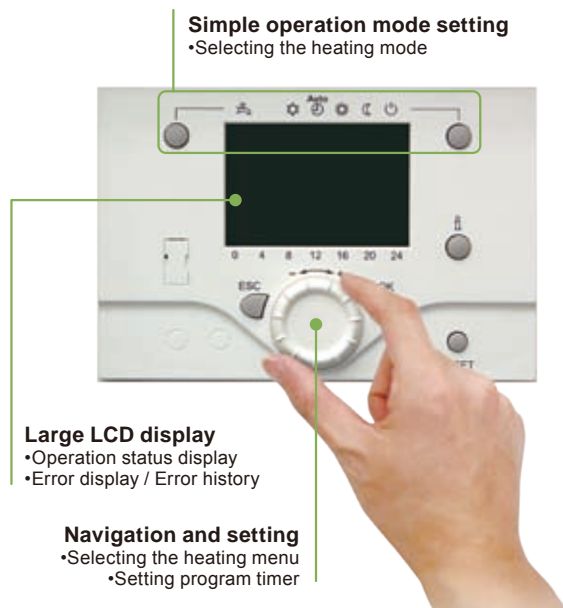

Comfort Control

• Automatic heating curve operation

Automatic heating curve control based on outdoor temperature and setting room temperature.

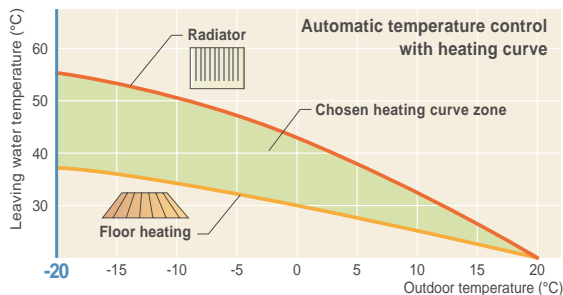

• Heating curve off-set

Automatic heating curve can be fine adjusted when too warm or too cold.

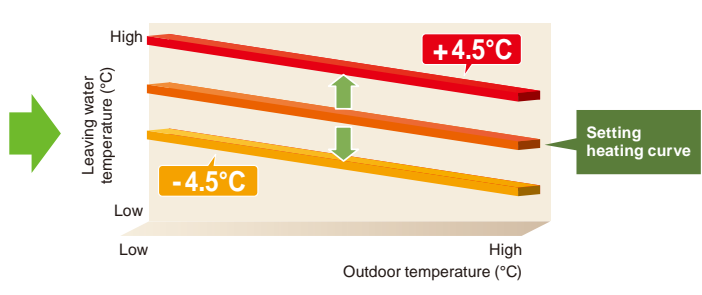

Convenience

• Programmed operation

- The setting of programmed operation can be easily set.
- Changing the heating mode linked with time is possible.

Heating mode



Automatic mode

Comfort/Reduce mode switching automatically according to outdoor temperature



Reduce mode

Constant reduce temperature



Comfort mode

Constant comfort temperature



Protection mode

Stand-by mode with anti-frost protection

• Day-Weekly timer setting

- The day-weekly timer can be set up for up to 3 times per day.
- Allows separate settings for each day of the week.

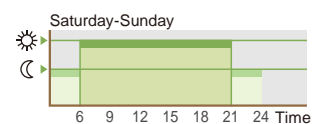
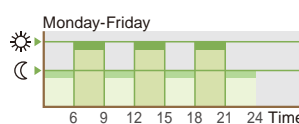

• Holiday timer setting

- The holiday timer can be set up for up to 8 periods.
- If you are absent for a long time in the winter, freezing of room can be prevented.

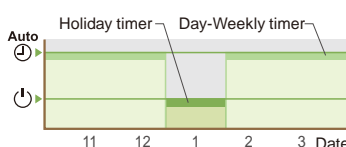

Extendibility

• Diverse operation control

Meets diverse needs by combining with optional parts.

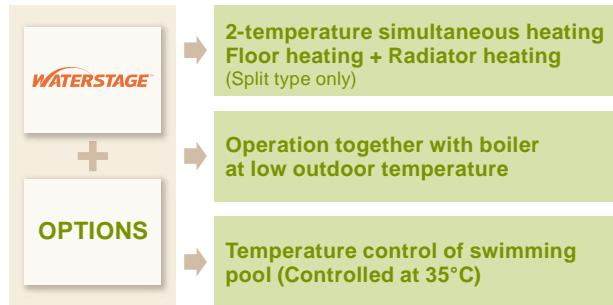

• Remote controller - Extension

Various remote controls are available on your hand.

Remote control is also available via Web. All kinds of life styles are supported

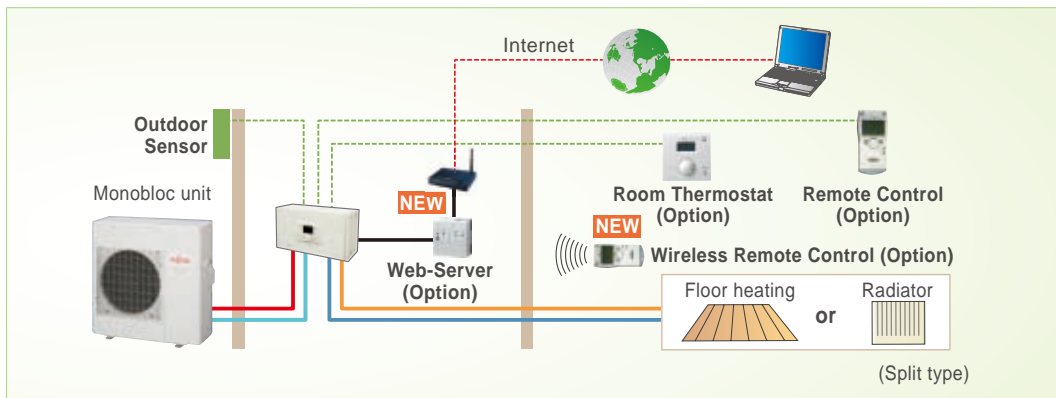

• Remote controller (Optional parts) - Eastern European Language* Spec.





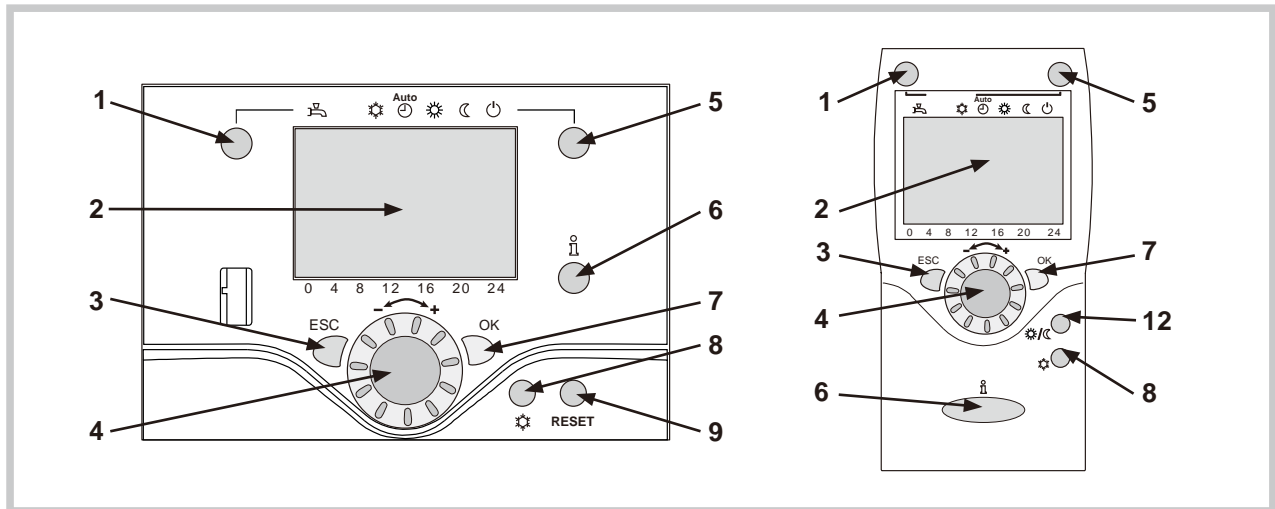

Optional parts	Model name
Remote control	UTW-C75XA-E
Remote control (Wireless)	UTW-C78XD-E

*Type of the corresponding languages: English, Czech, Slovakian, Polish, Turkish, Hungarian, Russian, Slovenian, Greek, Serbian

2. FUNCTIONS

2-1. USER INTERFACE (Control box) AND REMOTE CONTROL (Optional parts)



Ref .	Functions	- Definitions
1	Selecting DHW mode (Domestic Hot Water)  On  Off	<ul style="list-style-type: none"> - If the installation is fitted with a DHW tank. - On : Production of DHW according to the time program. - Off : Preparing the domestic hot water for stopping with the anti-frost function active. - Manual start button : Hold down the DHW key for 3 seconds. Switch from "reduced" to "comfort" until the next time the DHW timer switches over.
2	Digital display	<ul style="list-style-type: none"> - Operating control. Readout of the current temperature, the heating mode and any faults Δ. - View the settings
3	Exit "ESC"	<ul style="list-style-type: none"> - Quit the menu.
4	Navigation and setting	<ul style="list-style-type: none"> - Selecting the menu. - Setting parameters. - Adjusting the ambient temperature setpoint.
5	Selecting heating mode	<ul style="list-style-type: none"> -  Heating operation according to the heating program (Summer/Winter mode switchover is automatic). -  Constant comfort temperature. -  Constant reduced temperature. -  Stand-by mode with anti-frost protection (Provided that the heat pump's electrical power supply is not interrupted).

Ref .	Functions	- Definitions																																								
6	Information display	<p>- Various data.</p> <table border="1"> <thead> <tr> <th>Designation</th> <th>Line</th> </tr> </thead> <tbody> <tr> <td>Floor drying current setpoint</td> <td>-</td> </tr> <tr> <td>Current drying day</td> <td>-</td> </tr> <tr> <td>Terminated drying days</td> <td>-</td> </tr> <tr> <td>State heat pump</td> <td>8006</td> </tr> <tr> <td>State supplementary source</td> <td>8022</td> </tr> <tr> <td>State DHW</td> <td>8003</td> </tr> <tr> <td>State swimming pool</td> <td>8011</td> </tr> <tr> <td>State heating circuit 1</td> <td>8000</td> </tr> <tr> <td>State cooling circuit 1</td> <td>8004</td> </tr> <tr> <td>Outside temp</td> <td>8700</td> </tr> <tr> <td>Room temp 1</td> <td rowspan="2">8740</td> </tr> <tr> <td>Room setpoint 1</td> </tr> <tr> <td>Flow temp 1</td> <td rowspan="2">8743</td> </tr> <tr> <td>Flow temp setpoint 1</td> </tr> <tr> <td>DHW temp</td> <td rowspan="2">8830</td> </tr> <tr> <td>DHW temp setpoint</td> </tr> <tr> <td>Return temp HP</td> <td rowspan="2">8410</td> </tr> <tr> <td>Setpoint (return) HP</td> </tr> <tr> <td>Flow temp HP</td> <td rowspan="2">8412</td> </tr> <tr> <td>Setpoint (flow) HP</td> </tr> <tr> <td>Swimming pool temp</td> <td rowspan="2">8900</td> </tr> <tr> <td>Swimming pool setpoint</td> </tr> </tbody> </table> <p>Note: Ensure that the general electrical power supply has been cut off before starting any repair work. When the HP is not under tension, protection frost-free is not assured.</p> <p>-  Information concerning maintenance, special mode.</p>	Designation	Line	Floor drying current setpoint	-	Current drying day	-	Terminated drying days	-	State heat pump	8006	State supplementary source	8022	State DHW	8003	State swimming pool	8011	State heating circuit 1	8000	State cooling circuit 1	8004	Outside temp	8700	Room temp 1	8740	Room setpoint 1	Flow temp 1	8743	Flow temp setpoint 1	DHW temp	8830	DHW temp setpoint	Return temp HP	8410	Setpoint (return) HP	Flow temp HP	8412	Setpoint (flow) HP	Swimming pool temp	8900	Swimming pool setpoint
Designation	Line																																									
Floor drying current setpoint	-																																									
Current drying day	-																																									
Terminated drying days	-																																									
State heat pump	8006																																									
State supplementary source	8022																																									
State DHW	8003																																									
State swimming pool	8011																																									
State heating circuit 1	8000																																									
State cooling circuit 1	8004																																									
Outside temp	8700																																									
Room temp 1	8740																																									
Room setpoint 1																																										
Flow temp 1	8743																																									
Flow temp setpoint 1																																										
DHW temp	8830																																									
DHW temp setpoint																																										
Return temp HP	8410																																									
Setpoint (return) HP																																										
Flow temp HP	8412																																									
Setpoint (flow) HP																																										
Swimming pool temp	8900																																									
Swimming pool setpoint																																										

Ref .	Functions	- Definitions
-------	-----------	---------------

- 🔔 Reading error codes

Control box : Fault visible on the digital display.

Error number	Error contents	Error location	Heat pump operation despite the error
-	No connection	Failure to comply with room thermostat's polarity	No
10	Outdoor sensor	B9	Yes with OT = 0 °C
33	Flow sensor HP	B21	Yes
44	Return sensor HP	B71	Yes
50	DHW sensor	B3	Yes
60	Room sensor 1		Yes
105	Maintenance message		Yes
121	Flow temp HC1 not reached		Yes
127	Anti-legionella temp not reached		Yes
369	External fault (safety component)		No
370	Monobloc unit error	See below	No

Monobloc unit : The error codes displayed on the unit display board (PCB) indicate the location of the breakdown or abnormality.

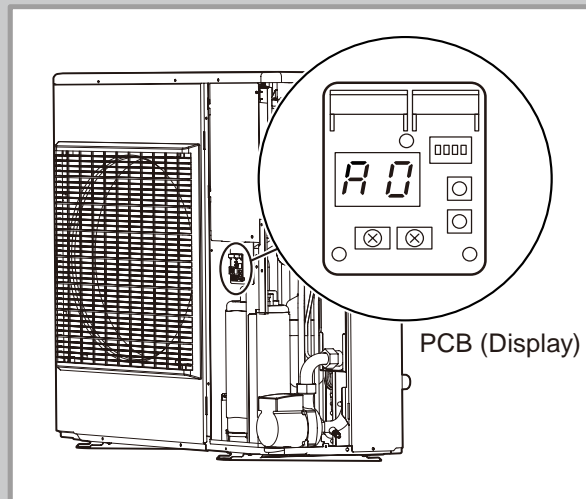

Error number	Error contents	Error number	Error contents
A0	DC voltage Error	A1	Discharge temperature Error
A2	Protective action against excess Current DC current detection	A3	CT disconnection
A4	Protective action against excess Current AC current detection	A5	Abnormal revolution of compressor
A6	Suction temp. sensor Error	A7	Defrost temp. sensor Error
A8	Discharge temp. sensor Error	C0	Power module Error
C2	Outdoor temp. sensor Error	C3	Fan motor Error
C4	Rise of temperature of power module	C5	Power module Error
C6	PCB (controller) Error	C7	I/F PCB serial error
CB	Inverter PCB serial error	CC	Heat pump regulator PCB serial error
E4	Outgoing circulating water temp. sensor Error	E5	Return circulating water temp. sensor Error
P1	Pump Error	U5	Low outside air temperature limit

CONTROL SYSTEM

CONTROL SYSTEM

Ref .	Functions	- Definitions
7	Confirm "OK"	<ul style="list-style-type: none"> - Input into the selected menu. - Confirmation of the parameter settings. - Confirmation of the adjustment to the comfort temp. setting.
8	Selecting cooling mode	- ❄️ Cooling operating according to the heating program (Summer/Winter mode switchover is automatic).
9	RESET button (Hold down the "RESET" key for less than 3 sec).	<ul style="list-style-type: none"> - Reinitialising the parameters and cancelling error messages. - Do not use during normal operation .

2-2. ROOM THERMOSTAT (Optional parts)

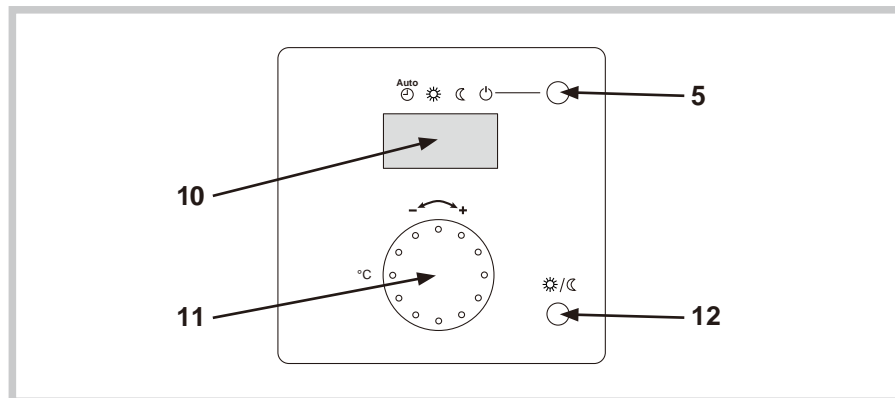

Ref .	Functions	- Definitions
5	Selecting heating mode	<ul style="list-style-type: none"> - ^{Auto} Heating operating according to the heating program (Summer/Winter mode switchover is automatic). - ☀ Constant comfort temperature. - C Constant reduced temperature. - ⏻ Stand-by mode with anti-frost protection (Provided that the heat pump's electrical power supply is not interrupted).
10	Digital display	- Operating control. Readout of the current temperature, of the heating mode and of any faults ⚠.
11	Control knob	- Adjusting room temperature setpoint.
12	Occupancy key	- Comfort / Reduced switchover.

2-3. CONTROL SETTING

■ GENERAL

The settings described below are those which can be modified by the user.

We wish to remind you that changing the settings below may cause the heat pump to behave in an undesirable way. A testing period should be conducted before the permanent settings of the heat pump are confirmed. This may require a number of changes to be made by the installer.

There are 3 access levels:

U: end-user level

I: commissioning level (installer start-up)

S: engineer level (specialist)

■ SETTING PARAMETERS

- Choose the desired level.
- Scroll the menu list.
- Choose the desired menu.
- Scroll the function lines.
- Choose the desired line.
- Adjust the parameter.
- Check the setting by pressing OK.
- To return the menu, press ESC.

If no setting is made for 8 minutes, the screen returns automatically to the basic display.

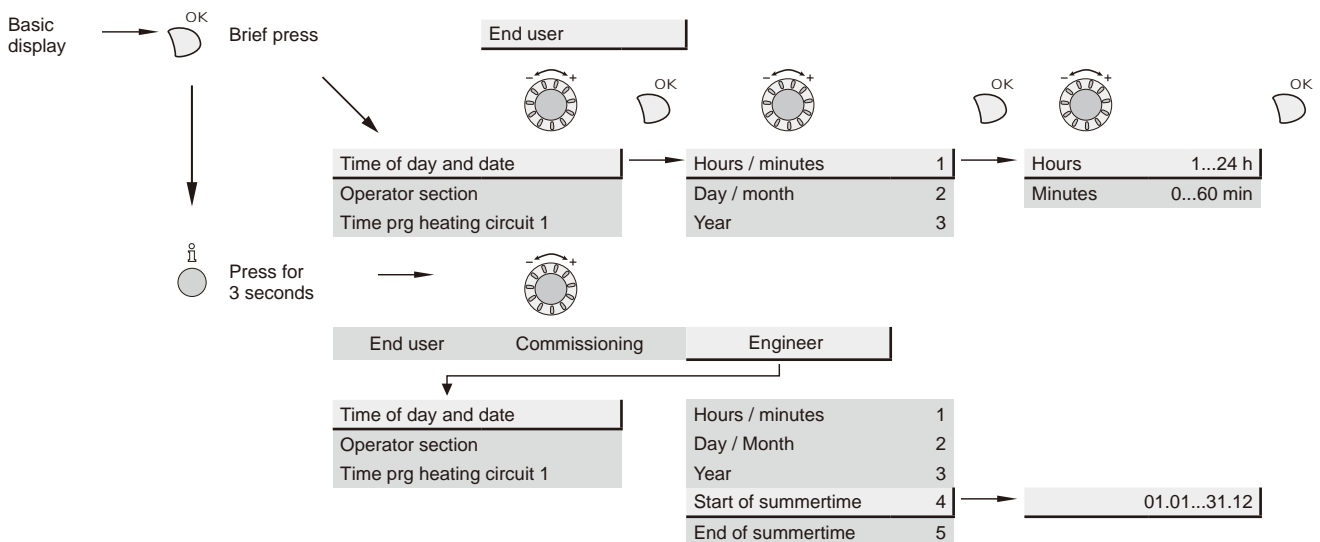

FUNCTION TABLE

LINE	ACCESS LEVEL	FUNCTION	SETTING RANGE OR DISPLAY	FACTORY SETTING
Time of day and date				
1	U	Hours/minutes	00:00...23:59	
2	U	Day/month	01.01...31.12	
3	U	Year	1900...2099	
5	S	Start of summertime	01.01...31.12	25.03
6	S	End of summertime	01.01...31.12	25.10
Operator section				
20	U	Language	9 Languages	English
22	S	Info	Temporarily / Permanently	Temporarily
26	S	Operation lock	Off/On	Off
27	S	Programming lock	Off/On	Off
28	I	Direct adjustment	Storage with confirmation / Automatic storage	Storage with confirmation
40 *1	I	Used as	Room unit 1 Room unit 2 Room unit P Operator unit 1 Operator unit 2 Operator unit P Service unit	Room unit 1
42 *1	I	Assignment device 1	Heating circuit 1 Heating circuit 1 and 2 Heating circuit 1 and P All Heating circuits	Heating circuit 1
44	I	Operation HC2	Commonly with HC1 / Independently	Commonly with HC1
46	I	Operation HC3/P	Commonly with HC1 / Independently	Commonly with HC1
48 *1	I	Operator occupancy button	None Heating circuit 1 Heating circuit 2 Commonly	None
54 *1	I	Readjustment room sensor	-3.0...3.0°C	0.0°C
70	S	Software version (user interface)		
Time program heating circuit 1				
500	U	Preselection	Mo-Su / Mo-Fr / Sa - Su / Mo / Tu / We / Th / Fr / Sa / Su	Mo-Su
501	U	1 st phase on	00:00...23:50, --:--	06:00
502	U	1 st phase off	--:--, 00:10...24:00	22:00
503	U	2 nd phase on	00:00...23:50, --:--	--:--
504	U	2 nd phase off	--:--, 00:10...24:00	--:--
505	U	3 rd phase on	00:00...23:50, --:--	--:--
506	U	3 rd phase off	--:--, 00:10...24:00	--:--
516	U	Default values	No/Yes	No

LINE	ACCESS LEVEL	FUNCTION	SETTING RANGE OR DISPLAY	FACTORY SETTING
Time program 3 / HCP				
540	U	Preselection	Mo-Su / Mo-Fr / Sa - Su / Mo / Tu / We / Th / Fr / Sa / Su	Mo-Su
541	U	1 st phase on	00:00...23:50, --:--	06:00
542	U	1 st phase off	--:--, 00:10...24:00	22:00
543	U	2 nd phase on	00:00...23:50, --:--	--:--
544	U	2 nd phase off	--:--, 00:10...24:00	--:--
545	U	3 rd phase on	00:00...23:50, --:--	--:--
546	U	3 rd phase off	--:--, 00:10...24:00	--:--
556	U	Default values	No/Yes	No
Time program 4 / DHW				
560	U	Preselection	Mo-Su / Mo-Fr / Sa - Su / Mo / Tu / We / Th / Fr / Sa / Su	Mo-Su
561	U	1 st phase on	00:00...23:50, --:--	00:00
562	U	1 st phase off	--:--, 00:10...24:00	05:00
563	U	2 nd phase on	00:00...23:50, --:--	--:--
564	U	2 nd phase off	--:--, 00:10...24:00	--:--
565	U	3 rd phase on	00:00...23:50, --:--	--:--
566	U	3 rd phase off	--:--, 00:10...24:00	--:--
576	U	Default values	No/Yes	No
Time program 5				
600	U	Preselection	Mo-Su / Mo-Fr / Sa - Su / Mo / Tu / We / Th / Fr / Sa / Su	Mo-Su
601	U	1 st phase on	00:00...23:50, --:--	08:00
602	U	1 st phase off	--:--, 00:10...24:00	20:00
603	U	2 nd phase on	00:00...23:50, --:--	--:--
604	U	2 nd phase off	--:--, 00:10...24:00	--:--
605	U	3 rd phase on	00:00...23:50, --:--	--:--
606	U	3 rd phase off	--:--, 00:10...24:00	--:--
616	U	Default values	No/Yes	No
Holidays heating circuit 1				
641	U	Preselection	Period 1...8	Period 1
642	U	Start	--:--, 01.01...31.12	--:--
643	U	End	--:--, 01.01...31.12	--:--
648	U	Operation level	Frost protection / Reduced	Frost protection

LINE	ACCESS LEVEL	FUNCTION	SETTING RANGE OR DISPLAY	FACTORY SETTING
Heating circuit 1				
710	U	Comfort setpoint	from reduced setpoint to 35.0°C	20.0°C
712	U	Reduced setpoint	from frost protection setpoint to comfort setpoint	18.0°C
714	U	Frost protection setpoint	from 4.0°C to reduced setpoint	8.0°C
716	S	Comfort setpoint max	20.0...35.0°C	28.0°C
720	I	Heating curve slope	0.10...4.00	0.50
721	I	Heating curve displacement	-4.5...4.5°C	0.0°C
726	I	Heating curve adaption	Off/On	Off
730	I	Summer/winter heating limit	---, 8.0...30.0°C	18.0°C
732	S	24-hour heating limit	---, -10...10°C	-3°C
740	S	Flow temp setpoint min	8...95°C	8°C
741	S	Flow temp setpoint max	8...95°C	55°C
750	S	Room influence	---, 1...100%	20%
790	S	Optimum start control max	0...360min	120 min
791	S	Optimum stop control max	0...360min	120 min
800	S	Reduced setpoint increase start	---, -5...10°C	---°C
801	S	Reduced setpoint increase end	-30...0°C	-5°C
• 830	S	Mixing valve boost	0...50°C	0°C
• 834	S	Actuator running time	30...873sec	240sec
850	I	Floor curing function	Off Functional heating Curing heating Functional/Curing heating Curing/Functional heating Manually	Off
851	I	Floor curing setpoint manually	0...95°C	25°C
856	I	Floor curing day current	0...32	0
857	I	Floor curing days completed	0...32	0
900	S	Operating mode changeover	None / Protection / Reduced / Comfort / Automatic	Protection

LINE	ACCESS LEVEL	FUNCTION	SETTING RANGE OR DISPLAY	FACTORY SETTING
Cooling circuit 1				
901	U	Operating mode	Off / Automatic	Off
902	U	Comfort setpoint	17.0...40.0°C	24.0°C
907	U	Release	24h/day Time program HC Time program 5	Time program 5
908	I	Flow temp setpoint at OT 25°C	6.0...35.0°C	20.0°C
909	I	Flow temp setpoint at OT 35°C	6.0...35.0°C	16.0°C
912	I	Cooling limit at OT	---, 8.0...35.0°C	24.0°C
913	S	Lock time at end of heating	---, 8...100h	24h
918	S	Summer compensation start at OT	20...50°C	26°C
919	S	Summer compensation end at OT	20...50°C	40°C
920	S	Summer compensation setpoint increase	---, 1.0...10.0°C	4.0°C
923	S	Flow temp setpoint min OT 25°C	6.0...35.0°C	18.0°C
924	S	Flow temp setpoint min OT 35°C	6.0...35.0°C	18.0°C
928	S	Room influence	---, 1...100%	80%
932	S	Room temp limitation	---, 0.5...4.0°C	0.5°C
• 938	S	Mixing valve decrease	0...20°C	0°C
• 941	S	Actuator running time	30...873sec	240sec
• 945	S	Mixing valve heating mode	Control / Open	Control
• 946	S	Lock time dewpoint limiter	---, 10...600min	60min
• 947	S	Flow temp setpoint increase hygrostat	---, 1...20°C	10°C
• 948	S	Flow setpoint increase start at relative humidity	0...100%	60%
• 950	S	Flow temp differential dewpoint	--, 0...5°C	2°C
963	S	With primary controller/system pump	No/Yes	No
969	S	Operating mode changeover	None / Off / Automatic	Off
Domestic hot water				
1610	U	Nominal setpoint	from reduced setpoint to 65°C	50°C
1612	U	Reduced setpoint	from 8°C to nominal setpoint	25°C
1620	I	Release	24h/day Time programs HCs Time program 4/DHW Low-tariff Time program 4/DHW or low-tariff	Time program 4/DHW
1640	I	Legionella function	Off Periodically Fixed weekday	Off
1641	I	Legionella function periodically	1...7	7
1642	I	Legionella function weekday	Monday...Sunday	Saturday
1644	I	Legionella function time	--:--, 00:00...23:50	--:--
1645	I	Legionella function setpoint	55...95°C	65°C
1646	I	Legionella function duration	--:--, 10...360min	30min
1647	I	Legionella function circulation pump	Off / On	On
1660	I	Circulating pump release	Time program 3/HCP DHW release Time program 4/DHW	DHW release
Swimming pool				
2056	U	Setpoint source heating	8.0...35.0°C	22.0°C

LINE	ACCESS LEVEL	FUNCTION	SETTING RANGE OR DISPLAY	FACTORY SETTING
Heat pump				
2844	S	Switch-off temp max	8...100°C	55°C
2882	S	Release integral electric flow	0...500°Cmin	100°Cmin
2884	S	Release electric flow below OT	---, -30...30°C	2°C
2910	S	Release above outside temp	---, -30...30°C	---°C
2920	S	With electrical utility lock	Locked / Release	Released
Supplementary source				
3700	S	Release below outside temp	---, -50...50°C	2.0°C
3705	S	Overrun time	0...120min	20min
3720	S	Switching integral	0...500°Cmin	100°Cmin
DHW storage tank				
5020	S	Flow setpoint boost	0...30°C	5°C
5024	S	Switching differential	0...20°C	7°C
5030	S	Charging time limitation	---, 10...600min	90min
5060	S	Electric immersion heater operating mode	Substitute Summer Always Cooling mode	Substitute
5061	S	Electric immersion heater release	24h/day DHW release Time program 4/DHW	DHW release
Configuration				
5700	I	Presetting	---, 1...12	1
5711	S	Cooling circuit 1	Off 4-pipe system 2-pipe system	Off
5870	S	Combination storage tank	No/Yes	No
5987	S	Contact type input EX4	NC (Normally-closed contact) NO (Normally-opened contact)	NO
5989	S	Contact type input EX5	NC (Normally-closed contact) NO (Normally-opened contact)	NC
6046	I	Function input H2	Operating mode change HCs+DHW Operating mode changeover HCs Operating mode changeover HC1 Operating mode changeover HC2 Error/alarm message Dewpoint monitor Release swimming pool	Dewpoint monitor
6047	I	Contact type H2	NC (Normally-closed contact) NO (Normally-opened contact)	NO
6048	S	Function value contact H2	0...130°C	45°C
6100	S	Readjustm outside sensor	-3.0...3.0°C	0.0°C
6120	S	Frost protection plant	Off / On	On
6205	S	Reset to default parameters	No/Yes	No
6220	S	Software version (heat pump regulator)		

LINE	ACCESS LEVEL	FUNCTION	SETTING RANGE OR DISPLAY	FACTORY SETTING
Fault				
6711	U	Reset HP	No/Yes	No
6740	S	Flow temp 1 alarm	---, 10...240min	---min
6741	S	Flow temp 2 alarm	---, 10...240min	---min
6745	S	DHW charging alarm	---, 1...48h	---h
6746	S	Flow temp cooling 1 alarm	---, 10...240min	---min
6800	S	History 1	Date/Time/Code	
6802	S	History 2	Date/Time/Code	
6804	S	History 3	Date/Time/Code	
6806	S	History 4	Date/Time/Code	
6808	S	History 5	Date/Time/Code	
6810	S	History 6	Date/Time/Code	
6812	S	History 7	Date/Time/Code	
6814	S	History 8	Date/Time/Code	
6816	S	History 9	Date/Time/Code	
6818	S	History 10	Date/Time/Code	
Service / special operation				
7070	S	HP interval	---, 1..240 months	---months
7071	S	HP time since maintenance	0...240months	0months
		Reset?	Yes / No	Yes
7072	S	Max starts compressor 1/hrs run	---, 0.1...12.0	---
7073	S	Cur starts compressor 1/hrs run	0.0...12.0	0
		Reset?	Yes / No	Yes
7076	S	Differential condenser max/week	---, 1...250	---
7077	S	Cur differential condenser max/week	0...250	0
		Reset?	Yes / No	Yes
7078	S	Differential condenser min/week	---, 1...250	---
7079	S	Cur differential condenser min/week	0...250	0
		Reset?	Yes / No	Yes
7090	S	DHW storage tank interval	---, 1...240months	---months
7091	S	DHW storage tank since maintenance	0...240months	0months
		Reset?	Yes / No	Yes
7141	U	Emergency operation	Off / On	Off
7142	S	Emergency operation function type	Manually / Automatically	Manually
7150	I	Simulation outdoor temp	---, -50...50°C	---°C
7181	I	Phone no. responsibility 1		-
7183	I	Phone no. responsibility 2		-

LINE	ACCESS LEVEL	FUNCTION	SETTING RANGE OR DISPLAY	FACTORY SETTING
Input/output test				
7700	I	Relay test	No test Everything off Relay output QX23 module 1 Relay output QX21 module 1 Relay output QX22 module 1 Relay output QX1 Relay output QX2 Relay output QX3 Relay output QX4 Relay output QX5 Relay output QX6 Relay output QX23 module 2 Relay output QX21 module 2 Relay output QX22 module 2 Relay output QX7	No test
7710	I	Output test UX	---, 0...100%	---%
7711	I	Voltage value UX	0.0...10.0V	---V
7720	I	Output test digital	No test Everything off Digital output DO1 Digital output DO2	No test
7721	I	Digital output DO1	Cooling mode Heating mode	Heating mode
7722	I	Digital output DO2	Off / On	Off
7730	I	Outdoor temp B9	-50...50°C	---°C
7820	I	Sensor temp BX1	-28...350°C	---°C
7823	I	Sensor temp BX4	-28...350°C	---°C
7824	I	Sensor temp BX5	-28...350°C	---°C
7830	I	Sensor temp BX21 module 1	-28...350°C	---°C
7831	I	Sensor temp BX22 module 1	-28...350°C	---°C
7832	I	Sensor temp BX21 module 2	-28...350°C	---°C
7833	I	Sensor temp BX22 module 2	-28...350°C	---°C
7841	I	Contact state H1	Open/Closed	Open
7846	I	Contact state H2	Open/Closed	Open
7855	I	Contact state H3	Open/Closed	Open
7914	I	Input EX4	0/230V	0V
7915	I	Input EX5	0/230V	0V
7916	I	Input EX6	0/230V	0V

LINE	ACCESS LEVEL	FUNCTION	SETTING RANGE OR DISPLAY	FACTORY SETTING
State				
8000	I	State heating circuit 1		---
8001	I	State heating circuit 2		---
8003	I	State DHW		---
8004	I	State cooling circuit 1		---
8006	I	State heat pump		---
8011	I	State swimming pool		---
8022	I	State supplementary source		---
8050	I	History 1	Date/Time/Code	
8052	I	History 2	Date/Time/Code	
8054	I	History 3	Date/Time/Code	
8056	I	History 4	Date/Time/Code	
8058	I	History 5	Date/Time/Code	
8060	I	History 6	Date/Time/Code	
8062	I	History 7	Date/Time/Code	
8064	I	History 8	Date/Time/Code	
8066	I	History 9	Date/Time/Code	
8068	I	History 10	Date/Time/Code	
Diagnostics heat generation				
8402	I	Electric immersion heater 1 flow	Off/On	Off
8403	I	Electric immersion heater 2 flow	Off/On	Off
8406	I	Condenser pump	Off/On	Off
8410	U	Return temp HP	0.0...140.0°C	0.0°C
		Setpoint HP	0.0...140.0°C	0.0°C
8412	U	Flow temp HP	0.0...140.0°C	0.0°C
		Setpoint HP	0.0...140.0°C	0.0°C
8413	U	Compressor modulation	0...100%	0%
8425	I	Temp differential condenser	-50...140°C	0°C
8454	S	Locking time HP		
		Reset?	Yes / No	Yes
8455	S	Counter number of locks HP		
		Reset?	Yes / No	Yes
8456	S	Hours run electric flow		
		Reset?	Yes / No	Yes
8457	S	Start counter electric flow		
		Reset?	Yes / No	Yes

LINE	ACCESS LEVEL	FUNCTION	SETTING RANGE OR DISPLAY	FACTORY SETTING
Diagnostics consumers				
8700	U	Outside temp	-50...50°C	0°C
8701	U	Outside temp min	-50...50°C	50°C
		Reset?	Yes / No	Yes
8702	U	Outside temp max	-50...50°C	-50°C
		Reset?	Yes / No	Yes
8703	I	Outside temp attenuated *2	-50...50°C	0°C
		Reset?	Yes / No	Yes
8704	I	Outside temp composite *3	-50...50°C	0°C
8730	I	Heating circuit pump 1	Off / On	Off
8731	I	Heating circuit mix valve 1 open	Off / On	Off
8732	I	Heating circuit mix valve 1 close	Off / On	Off
8740	U	Room temp 1	0.0...50.0°C	20.0°C
		Room setpoint 1	4.0...35.0°C	20.0°C
8743	U	Flow temp 1	0.0...140.0°C	50.0°C
		Flow temp setpoint 1	0.0...140.0°C	50.0°C
8756	U	Flow temp cooling 1	0.0...140.0°C	0.0°C
		Flow temp setpoint cooling 1	0.0...140.0°C	0.0°C
• 8760	I	Heating circuit pump 2	Off / On	Off
• 8761	I	Heating circuit mix valve 2 open	Off / On	Off
• 8762	I	Heating circuit mix valve 2 close	Off / On	Off
• 8770	U	Room temp 2	0.0...50.0°C	20.0°C
		Room setpoint 2	4.0...35.0°C	20.0°C
• 8773	U	Flow temp 2	0.0...140.0°C	50.0°C
		Flow temp setpoint 2	0.0...140.0°C	50.0°C
8820	I	DHW pump	Off / On	Off
8821	I	Electric immersion heater DHW	Off / On	Off
8830	U	DHW temp	0.0...140.0°C	0.0°C
		DHW temp setpoint	8.0...80.0°C	55.0°C
8840	S	Hours run DHW pump		
		Reset?	Yes / No	Yes
8841	S	Start counter DHW pump		
		Reset?	Yes / No	Yes
8842	S	Hours run electric heater DHW		
		Reset?	Yes / No	Yes
8843	S	Start counter electric heater DHW		
		Reset?	Yes / No	Yes
8900	U	Swimming pool temp	0.0...140.0°C	0.0°C
		Swimming pool setpoint	8.0...80.0°C	24.0°C
8950	I	Common flow temp	0.0...140.0°C	0.0°C
		Common flow temp setpoint	0.0...140.0°C	0.0°C
8957	I	Common flow setpoint refrig	0.0...140.0°C	0.0°C

LINE	ACCESS LEVEL	FUNCTION	SETTING RANGE OR DISPLAY	FACTORY SETTING
9031	I	Relay output QX1	Off / On	Off
9032	I	Relay output QX2	Off / On	Off
9033	I	Relay output QX3	Off / On	Off
9034	I	Relay output QX4	Off / On	Off
9035	I	Relay output QX5	Off / On	Off
9036	I	Relay output QX6	Off / On	Off
9037	I	Relay output QX7	Off / On	Off
9050	I	Relay output QX21 module 1	Off / On	Off
9051	I	Relay output QX22 module 1	Off / On	Off
9052	I	Relay output QX23 module 1	Off / On	Off
9053	I	Relay output QX21 module 2	Off / On	Off
9054	I	Relay output QX22 module 2	Off / On	Off
9055	I	Relay output QX23 module 2	Off / On	Off

Description of abbreviations :

HC = Heating circuit

OT = Outside temperature

HP = Heat pump

DHW = Domestic hot water

B9, BX1, BX4, BX5, BX21, BX22, DO1, DO2, EX4, EX5, EX6, H1, H2, H3, QX1, QX2, QX3, QX4, QX5, QX6, QX7, QX21, QX22, QX23, UX = Terminal number

*1: Applied only to Remote control C75

*2: " Attenuated outside temperature " is calculated by means of filtered outdoor temperature and the building time constant (building's thermal inertia).

*3: " Composite outside temperature " is calculated by means of the filtered outdoor temperature, the building time constant and the actual outside temperature.

● : These parameters are not used in this system.

■ ADJUSTMENT FUNCTION DETAILS

● Time of day and date functions

The controller has an annual clock which contains the time, the day of the week and the date.

In order for the function to operate, the time and date must be set properly on the clock.

LINE	FUNCTION
1	Hours / minutes
2	Day / month
3	Year
5	Start of summertime
6	End of summertime

Note:

Summer time/winter time change

Dates have been set for changing to summer time or to winter time. The time changes automatically from 2am (winter time) to 3am (summer time) or from 3am (summer time) to 2am (winter time) on the first Sunday following the respective date.

● Operator section functions

LINE	FUNCTION
20	Language
22	Info
26	Operation lock
27	Programming lock
28	Direct adjustment

Info

• Temporarily

After pressing the Info key, the information display returns "predefined" basic display after 8 minutes or when pressing the operating mode key.

• Permanently

After pressing the Info key, the information display returns to "new" basic display after a maximum of 8 minutes. The last selected information value is shown in the new basic display.

Operation lock

If the operating lock is activated, the following control elements can no longer be adjusted: Heating circuit mode, DHW mode, room temp comfort setpoint (knob), occupancy key.

Programming lock

If the programming lock is activated, the setting values are displayed but may no longer be changed.

Temporary suspension of programming:

The programming lock can be temporarily deactivated at programming level. To do this, simultaneously press OK and ESC keys for at least 3 seconds. The temporary suspension of the programming lock remains in effect until you exit the programming.

Permanent suspension of programming:

First perform a temporary suspension, then cancel "Programming lock" on line 27.

Direct adjustment

• Storage with confirmation

Correction of the setpoint with the knob will be adopted only after pressing OK key.

• Automatic storage

Correction of the setpoint with the knob is adopted without a particular confirmation (timeout) or by pressing OK key.

LINE	FUNCTION
40*	Used as (Room unit 1 / Room unit 2 / Room unit P / Operator unit 1 / Operator unit 2 / Operator unit P / Service unit)

* applies only to Remote control C75

Used as

This line allows adjusting a use of the user interface. According to the use, other settings will be required under "Heating circuit assignment". If several user interfaces are used, operation of each device can be defined respectively.

- If several user interfaces are used, each device address may be used only once.
- The user interface mounted to the control box is set in the factory as operating device 1 (line 40)

which has an effect on all heating circuits (line 42) and can be configured only on lines 44, 46, 48.

Depending on how the device is used line 40, the following adjustments can be made for assignment to the heating circuits with the following effects:

FUNCTION					
40	42	44	46	48	54
Room unit 1	Heating circuit 1				X
	Heating circuits 1 and 2	X		X	X
	Heating circuits 1 and P		X	X	X
	All HCs				
Room unit 2					
Room unit P					
Operator unit 1	Heating circuit 1				
	Heating circuits 1 and 2	X		X	
	Heating circuits 1 and P		X	X	
	All HCs	X	X	X	
Operator unit 2					
Operator unit P					
Service unit					

- **Room unit 1**

The user interface controls the heating circuits which are authorized on line 42 "Room unit 1 assignment" and which have been activated accordingly in the base unit.

- **Room unit 2**

This option is not applicable to this system.

- **Operator unit**

The user interface controls the heating circuits that have been activated in the base unit.

Note:

With this setting, no room temperature is saved or transmitted by the user interface.

Heating Circuit Assignment

LINE	FUNCTION
42*	Assignment device 1
• 44	Operation HC2
46	Operation HC3/P
48*	Operator occupancy button
54*	Readjustment room sensor
70	Software version (user interface)

* applies only to Remote control C75

• : This parameter is not used in this system.

Assignment device 1

As device 1 (line 40), action of the respective user interface can be assigned either to heating circuit 1 or to both heating circuits.

Note:

Heating circuit 2 is not available under control of this system.

Operation HC3/P

Depending on the setting of line 40, the operating action (operating mode key or knob) can be defined either on room unit 1, on the user interface, or on the operating unit for heating circuit P.

• **Commonly with HC1**

The control for heating circuit 1 and P is shared.

• **Independently**

Changes in the operating mode or adjustment of the nominal temperature setpoint must be made in the programming.

Readjustment room sensor

The room sensor display can be corrected.

Software version (user interface)

The display shows the current version of the user interface.

● Time program functions (Heating circuit, DHW, Cooling)

Several control programs are available for the heating circuit and the production of DHW. They are initiated in "Automatic" mode and control the change in temperature levels (and therefore the associated setpoints, reduced and comfort) via the adjusted changeover times.

Enter changeover times:

Changeover times can be adjusted in a combined way, i.e., identical times for several days or distinct times for certain days. Preselecting groups of days (e.g., Mon...Fri and Sat...Sun) having the same changeover times makes adjustment of the changeover program considerably shorter.

Changeover Points

LINE			FUNCTION
HC1	4/DHW	5	
500	560	600	Preselection (Mo-Su / Mo-Fr / Sa – Su / Mo...Su)
501	561	601	1 st phase on
502	562	602	1 st phase off
503	563	603	2 nd phase on
504	564	604	2 nd phase off
505	565	605	3 rd phase on
506	566	606	3 rd phase off

Standard Program

LINE	FUNCTION
516, 576, 616	Default values (No /Yes)

All time programs can be reset to factory settings. Each time program has its own programming line for this reset action.

In this case, individual settings will be lost!

Holidays

LINE	FUNCTION
HC1	
641	Preselection
642	Start
643	End
648	Operation level

The holiday program enables changing the heating circuit over to a selected operating level according to the date (calendar).

Important:

The holiday program can be used only in the automatic mode.

● Heating circuit functions

Operating Mode

For heating circuit there are several functions available.

Operation of heating circuit is directly controlled via the operating mode key.

Setpoint Values

LINE	FUNCTION
HC1	
710	Comfort setpoint
712	Reduced setpoint
714	Frost protection setpoint
716	Comfort setpoint max

Room temperature:

Room temperature can be set according to different setpoint values. Depending on the selected mode, these setpoints are activated and provide different temperature levels in the rooms.

The ranges of configurable setpoints are defined by their interdependencies, as shown in the graph below.

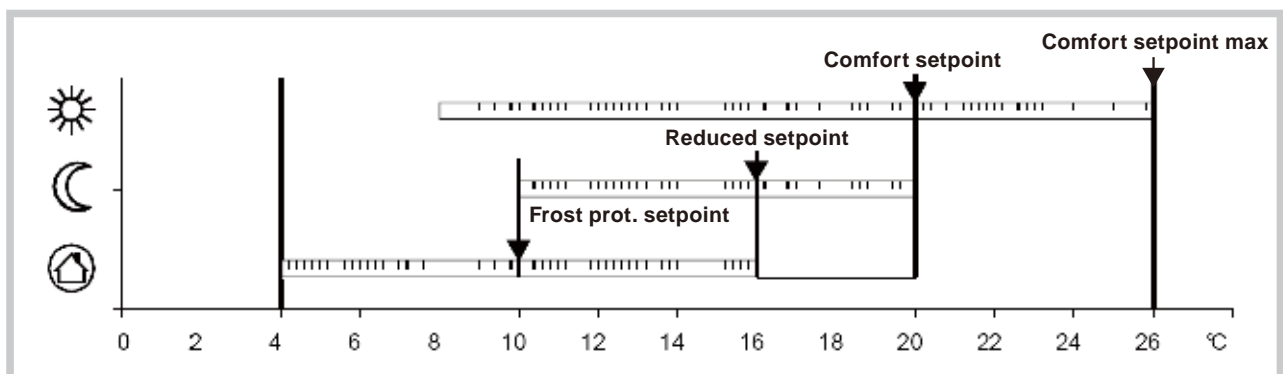

Frost protection:

The protection mode automatically prevents an excessively sharp drop in room temperature.

In this case the control adopts the frost protection room setpoint.

Heating Curve

LINE	FUNCTION
HC1	
720	Heating curve slope
721	Heating curve displacement
726	Heating curve adaption

Heating curve slope

Based on the heating characteristic, the controller computes the flow temperature setpoint which will be used for controlling the flow temperature in consideration of atmospheric conditions. Different settings can be used to adapt the heating characteristic so that the heating capacity, and therefore the room temperature, will match the individual needs.

The colder the outdoor temperature, the greater the extent to which the slope will modify the flow temperature. In other words, the slope should be corrected if the room temperature shows a difference when the outdoor temperature is low, but not when it is high.

- Increase the setting:
The flow temperature is increased mainly when the outdoor temperatures are low.
- Decrease the setting:
The flow temperature is lowered mainly when the outdoor temperatures are low.

Warning:

The heating curve is adjusted in relation to a room temperature setpoint of 20°C. If the room temperature setpoint is modified, the flow temperature setpoint is automatically recomputed. This will not modify the setting and amounts to automatically adapting the curve.

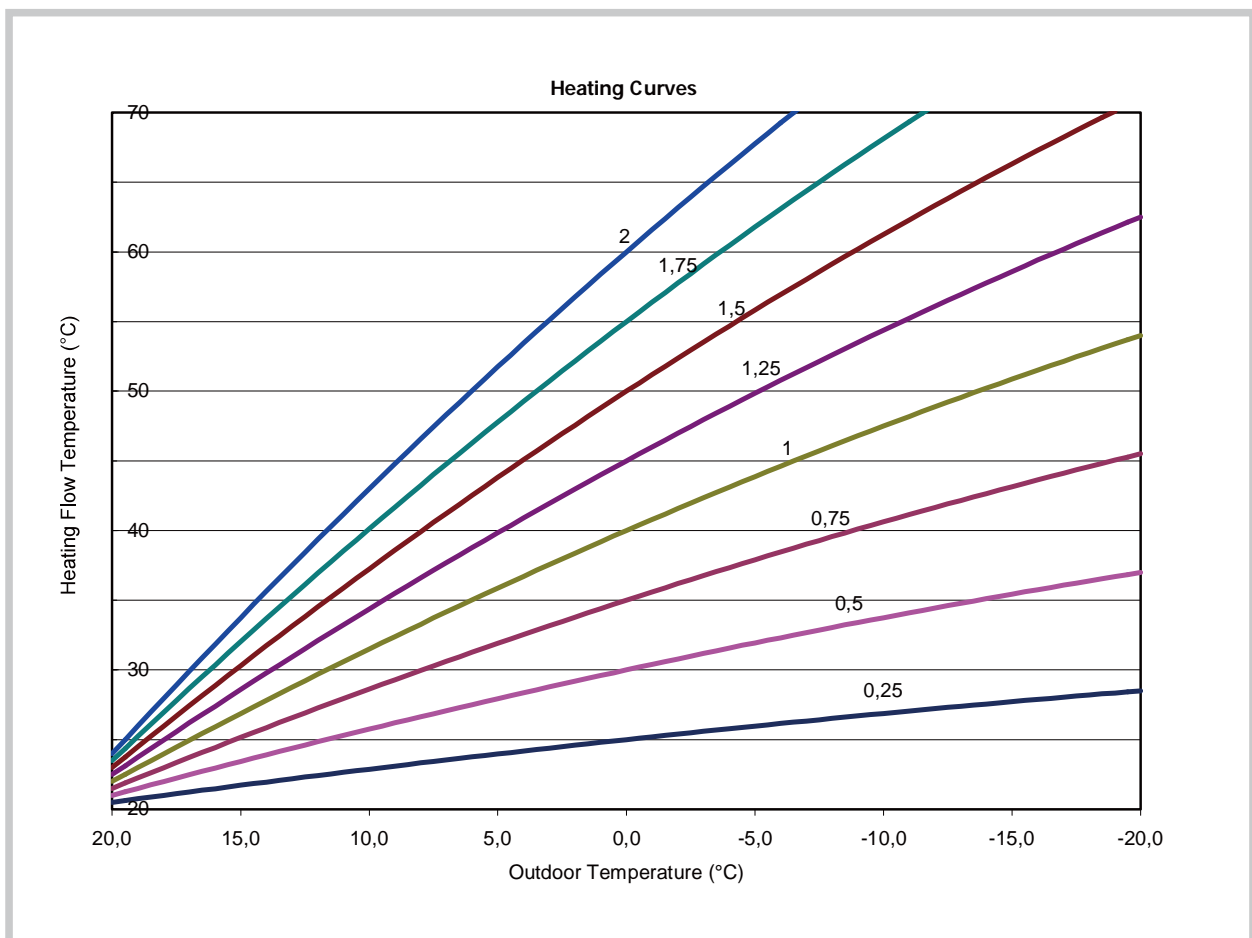

Heating curve displacement

The curve displacement (offset) modifies the flow temperature in a general and even manner over the full range of outdoor temperature. In other words, the displacement should be corrected when the room temperature is generally too high or too low.

Heating curve adaption

Adaptation enables the controller to automatically adapt the heating curve to the present conditions. This correction may only be activated or deactivated.

In the latter case, there is no need to correct the slope and displacement.

Information:

To ensure operation, the following requirements must be met:

- A room sensor must be connected.
- The "room influence" parameter must be set between 1 and 99.
- The reference room (where the room sensor is installed) must not contain adjusted thermostatic valves. If present in the room, these valves must be fully open.
- Operation of this function requires an adaptation period which can take more or less time (approx. 1 week) depending on weather conditions and on the stability of the room temperature setpoint.

Eco Functions

LINE	FUNCTION
HC1	
730	Summer/winter heating limit
732	24-hour heating limit

Summer/winter heating limit

The summer/winter heating limit switches the heating on or off through the year according to the temperature ratio. Changeover is performed automatically when in automatic mode and thus avoids the user having to turn the heating on or off. Changing the input value makes the respective annual periods (summer/winter) shorter or longer.

- If the value is increased:

Changing to winter operating mode is advanced, changing to summer mode is delayed.

- If the value is decreased:

Changing to winter mode is delayed; changing to summer mode is advanced.

Information:

This function does not work in "Continuous comfort temperature" mode. (Sunlight)

The controller displays "ECO".

The outdoor temperature is attenuated to take the building's dynamics into account.

Example:

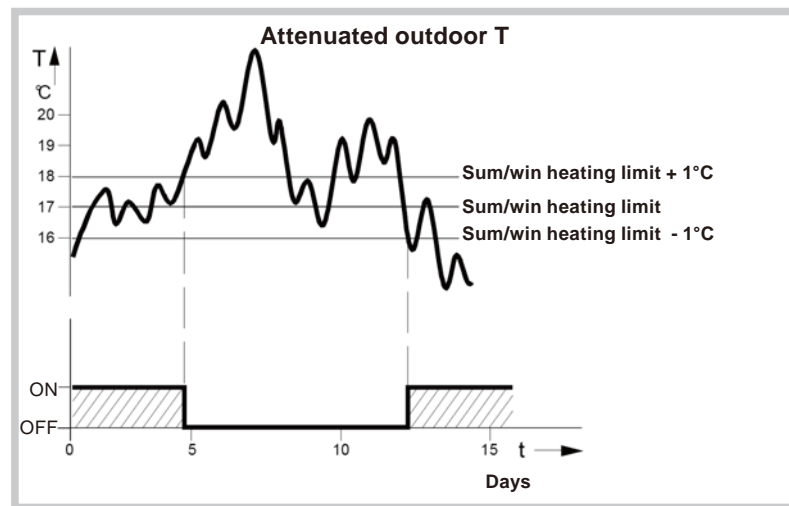

24-hour heating limit

The 24-hour heating limit is used to switch the heating on and off in the course of the day, depending on the outdoor temperature.

This function is used mainly during intermediate seasons (spring and fall) to react rapidly in case of fluctuating temperatures.

Thus, in the following example the changeover temperature will be 18°C, computed as follows:

Comfort setpoint (line 710)	22°C
24-hour heating limit (line 732)	-3°C
Changeover temperature (line 710 – 732) Heating off	=19°C
Differential (Fixed)	-1°C
Changeover temperature Heating on	=18°C

Changing the input value makes the respective heating periods shorter or longer.

- If the value is increased: changeover to heating mode is advanced; changeover to ECO is delayed.
- If the value is decreased: changeover to heating mode is delayed; changeover to ECO is advanced.

Information:

This function will not work in "Continuous Comfort temperature" mode.

The display will show "ECO".

The outdoor temperature is attenuated to take the building's thermal dynamics into account.

Flow temperature setpoint

LINE	FUNCTION
HC1	
740	Flow temp setpoint min
741	Flow temp setpoint max

This limitation allows to define a range for the flow temperature setpoint. When flow temperature setpoint demanded by the heating circuit reaches the threshold, the setpoint remains permanently at the maximum or minimum, even if the heat demand continues to increase or decrease.

Room Influence

LINE	FUNCTION
HC1	
750	Room influence

Control types:

When using a room temperature sensor there are 3 different types of control to choose from.

SETTING	CONTROL TYPE
- - - %	Simple control according to outdoor conditions *
1...99 %	Control according to outdoor conditions with room influence *
100 %	Control according to room temperature only

* Requires the connection of an outdoor sensor

Simple control according to outdoor conditions

The flow temperature is computed via the heating curve according to the composite outdoor temperature. This type of control requires proper adjustment of the heating curve, as the control does not take the room temperature into account for this adjustment.

Control according to outdoor conditions with room influence

The difference between the room temperature and the setpoint value is measured and taken into account for temperature control. This enables taking into account possible heat inputs and ensures a more accurate room temperature control. The influence of the difference is defined as a percentage. The better the installation in the reference room (accurate room temperature, correct installation location, etc.) the higher will be the value that can be set.

Example:

Approx 60%: the reference room is appropriate
Approx 20%: the reference room is inappropriate

Information:

Activation of the function requires taking into account the following requirements:

- A room sensor must be connected.
- The "room influence" parameter must be set between 1 and 99.
- The reference room (where the room sensor is installed) must not contain adjusted thermostatic valves. If present in the room, these valves must be fully open.

Control according to room temperature only

The flow temperature is adjusted according to the room temperature setpoint, the current room temperature and its evolution. A slight increase in room temperature, for example, causes an immediate drop in the flow temperature.

Information:

Activation of the function requires taking into account the following requirements:

- A room sensor must be connected.
- The "room influence" parameter must be set to 100%.

The reference room (where the room sensor is installed) must not contain adjusted thermostatic valves. If present in the room, these valves must be fully open.

Optimisation at switch-on and switch-off

LINE	FUNCTION
HC1	
790	Optimum start control max
791	Optimum stop control max

Optimum start control max

The change in temperature levels is optimised in such a way as to reach the comfort setpoint during changeover times.

Optimum stop control max

The change in temperature levels is optimised in such a way as to reach the comfort setpoint -1/4 °C during changeover times.

Reduced Setpoint Increase

LINE	FUNCTION
HC1	
800	Reduced setpoint increase start
801	Reduced setpoint increase end

This function is used mainly in heating installations that do not have high supplies of power (e.g. low power use homes). When outdoor temperatures are low, adjusting the temperature would take too long. Increasing the reduced setpoint prevents excessive

cooling of the rooms in order to shorten the temperature adjustment period when changing over to the comfort setpoint.

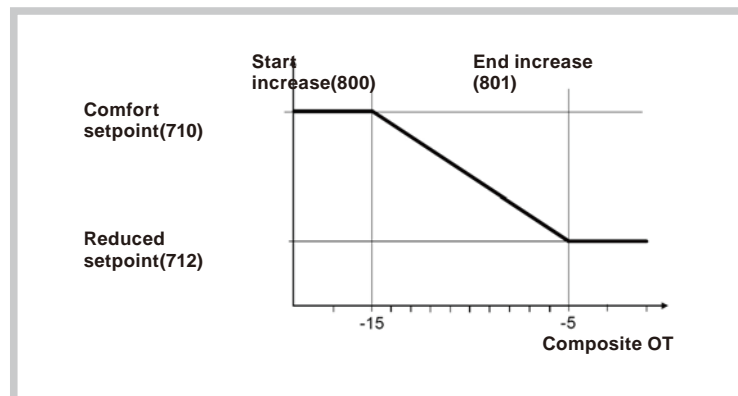

Mixing Valve Control

LINE	FUNCTION
HC1	
• 830	Mixing valve boost
• 834	Actuator running time

- : These parameters are not used in this system.

Controlled floor drying function

LINE	FUNCTION
HC1	
850	Floor curing function
851	Floor curing setpoint manually
856	Floor curing day current
857	Floor curing days completed

This function is used in the controlled drying of floors. It adjusts the flow temperature to a temperature profile. Drying is performed by floor heating via the heating circuit with a pump.

Floor curing function

• Off

The function is deactivated.

• Functional heating (Fh)

The first part of the temperature profile is automatically completed.

• Curing heating (Bh)

The second part of the temperature profile is handled automatically.

• Functional/Curing heating

The full temperature profile (1st and 2nd part) is performed automatically.

• Manually

No temperature profile is performed, but the control is performed according to the "manual controlled drying setpoint". The function is automatically terminated after 25 days

Important:

- The standards and directions of the building contractor must be followed!
- This function will not work properly unless the installation has been adequately made (hydraulics, electricity, settings). Otherwise, the floors to be dried may be damaged!
- The function may be prematurely interrupted by setting it to Off.
- The maximum flow temperature limitation remains active.

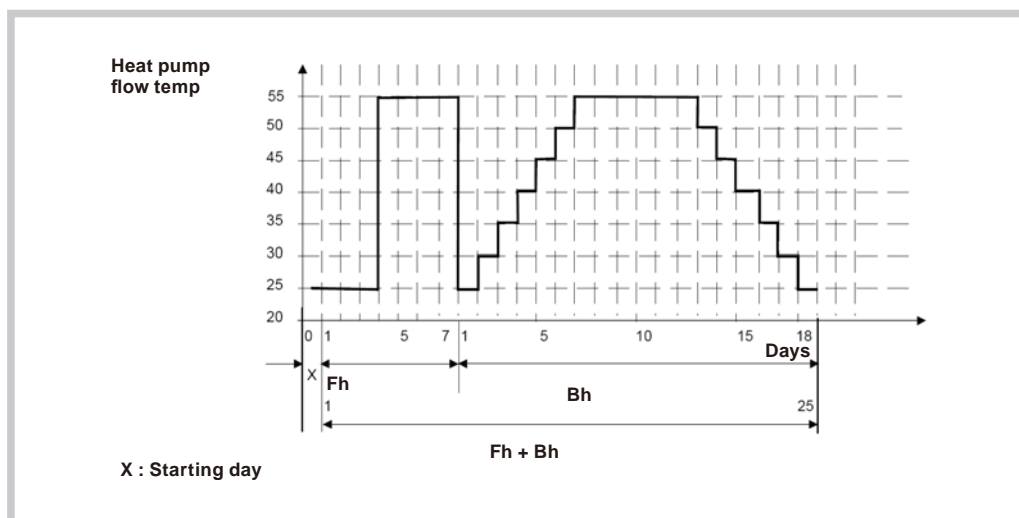

Floor curing setpoint manually

The flow temperature setpoint for the "Manually" controlled floor drying function can be adjusted respectively for each heating circuit.

Floor curing day current

Displays the current flow temperature setpoint for the controlled floor drying function.

Floor curing days completed

Displays the current day of the controlled floor drying function.

Important:

After a power outage, the installation resumes the controlled drying function as it was when the outage occurred.

Operating Mode Changeover

LINE	FUNCTION
HC1	
900	Operating mode changeover (None / Protection / Reduced / Comfort / Automatic)

In case of an external changeover via input H2 (on the extension module only) the operating mode to which the changeover will be performed must be previously defined.

Information:

The extension module is only applicable for a swimming pool to this system. This parameter must be defined on " Protection "

Heating Circuit Frost Protection

Information:

The heating circuit frost protection is continuously activated (protection mode ) and is not adjustable.

- Heating circuit frost protection in heating mode:
If the flow temperature is below 5°C, the controller initiates the production of heat and starts the heating pumps, regardless of the current heating mode.
If the flow temperature rises again above 7°C, the controller waits another 5 minutes, and then stops the production of heat and the heating pumps.
- Heating circuit frost protection in cooling mode:
See Cooling mode.

● Cooling circuit 1 functions

The cooling sequence is automatically started when the room temperature is higher than the comfort setpoint in cooling mode (line 902). The cooling function must be activated (line 901 = Auto) and is triggered by the programming clock (line 907). The cooling sequence is interrupted as soon as heating circuit 1 indicates a need for heat or in the presence of a heat demand signal from a DHW circuit or other heating circuit (only if cooling is active).

The controller measures the current room temperature and compares it with the room temperature setpoint to compute the flow temperature setpoint. If the temperature is not low enough the heat pump is started to provide cooling.

The following settings apply to the hydraulic circuit in zone 1 (HC1).

Warning:

Cooling mode is prohibited on all radiators, heating only floors, or any emitters not intended for this purpose.

Operating Mode

LINE	FUNCTION
901	Operating mode (Off / Automatic)

The cooling key on the user interface enables switching between operating modes.

- **Off**

The cooling function is deactivated.

- **Automatic**

The cooling function is automatically activated by the time program (line 907), the holiday program, the occupancy key, or according to the need.

Comfort cooling setpoint

LINE	FUNCTION
902	Comfort setpoint

In cooling mode the room temperature control follows the comfort setpoint adjusted under this setting. The cooling comfort setpoint can be displayed with a knob on the room unit.

In summer the comfort setpoint is gradually increased in relation to the outdoor temperature (see lines 918-920).

Release

LINE	FUNCTION
907	Release (24h/day / Time program HC / Time program 5)

The "Release" setting determines the time program according to which cooling is released.

- **24h/day**

Cooling is continuously activated (24h/Day).

- **Time program HC**

Cooling is activated according to the heating circuit time program.

- **Time program 5**

Cooling is released according to time program 5.

Cooling Characteristic

LINE	FUNCTION
908	Flow temp setpoint at OT 25°C
909	Flow temp setpoint at OT 35°C

The controller computes the flow temperature required for a given composite outdoor temperature based on the cooling characteristic. This is defined by two reference points (flow setpoint at 25°C and at 35°C).

Flow temp setpoint at OT 35°C

This is the cooling flow temperature required when the composite outdoor temperature is 35°C, without summer compensation.

Flow temp setpoint at OT 25°C

This is the cooling flow temperature required when the composite outdoor temperature is 25°C, without summer compensation.

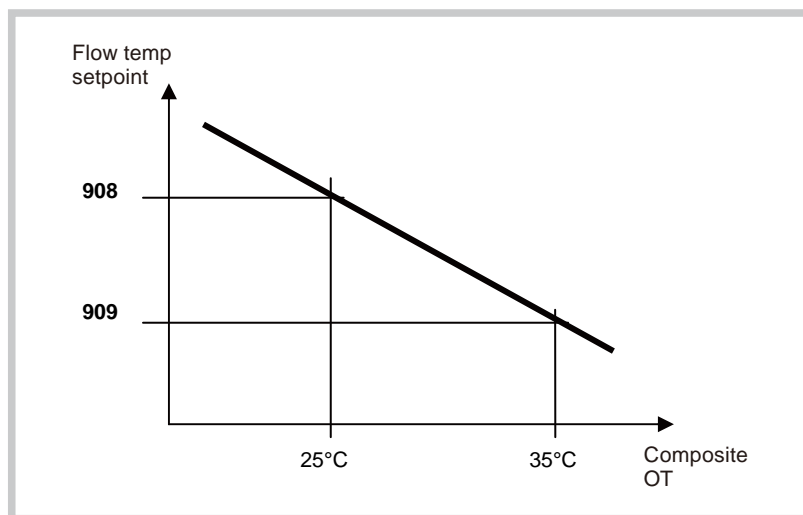

The cooling characteristic is adjusted for a 25°C room temperature setpoint. If the room temperature setpoint is changed the curve will automatically adapt.

Eco

LINE	FUNCTION
912	Cooling limit at OT
913	Lock time at end of heating

Cooling limit at OT

If the composite outdoor temperature is higher than the cooling limit, cooling is released. If the composite outdoor temperature falls at least 0.5°C below the cooling limit, cooling is locked.

The lock time starts when there is no valid heating demand from heating circuit 1. Heating demands from heating circuit P is ignored.

Information:

Switching off and switching on again the mode selection key causes the lock time to be interrupted.

Lock time at end of heating

To avoid a quick start of cooling after termination of heating, the cooling function is locked for a time period which can be adjusted with this setting.

Summer Compensation

LINE	FUNCTION
918	Summer compensation start at OT
919	Summer compensation end at OT
920	Summer compensation setpoint increase

In summer the "cooling comfort setpoint" (line 902) is gradually increased according to the outdoor temperature. This saves on cooling power and prevents the differences between the ambient temperature of the room and the outdoor temperature being too high.

The resulting "room temperature setpoint" can be viewed in the Info section.

Summer compensation start at OT

Summer compensation starts to be active from the outdoor temperature defined here. If the outdoor temperature continues to rise, the comfort setpoint will be gradually increased.

Summer compensation end at OT

At this outdoor temperature the summer compensation reaches its peak efficiency (line 920). If the outdoor temperature continues to rise, it will no longer influence the comfort setpoint.

Summer compensation setpoint increase

This setting defines the highest value to which the comfort setpoint can be increased.

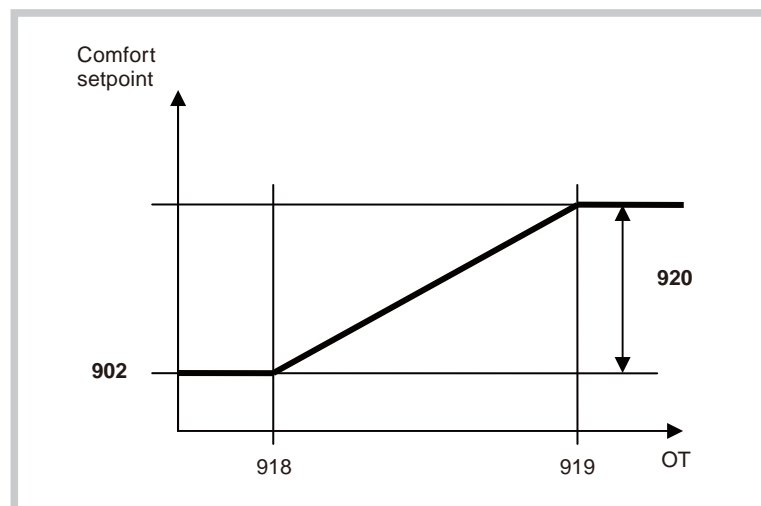

Flow Setpoint Limitation

LINE	FUNCTION
923	Flow temp setpoint min at OT 25°C
924	Flow temp setpoint min at OT 35°C

It is possible to assign a lower limit to the cooling flow temperature. The limitation line will be defined by two reference points. In addition the resulting flow setpoint will have a lower limit and may not be less than 5 °C.

Flow temp setpoint min at OT 25°C

Determines the lowest flow temperature for a composite outdoor temperature of 25°C.

Flow temp setpoint min at OT 35°C

Determines the lowest flow temperature for a composite outdoor temperature of 35°C.

Warning:

If no outdoor temperature is available, the controller will use the "Min. flow setpoint at OT= 35°C" parameter.

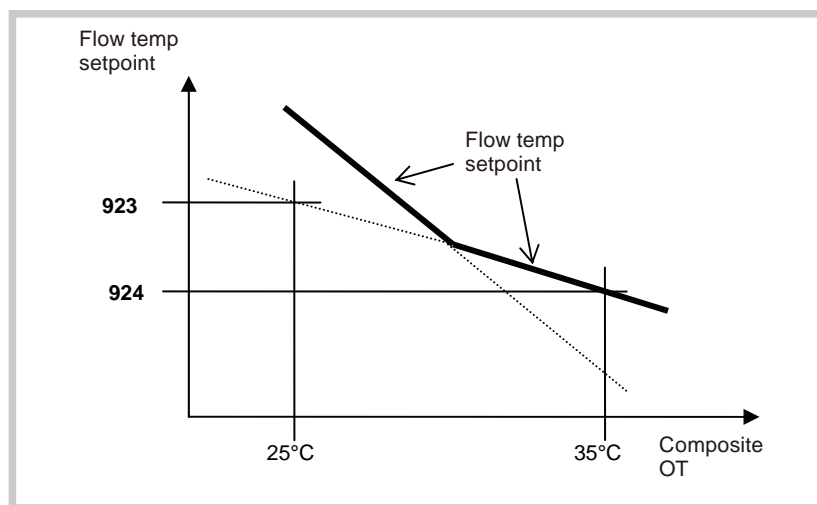

Room Influence

LINE	FUNCTION
928	Room influence

When using a room temperature sensor there are 3 different types of control to choose from.

SETTING	CONTROL TYPE
- - - %	Simple control according to outdoor conditions *
1...99 %	Control according to outdoor conditions with room influence *
100 %	Control according to room temperature only

* Requires the connection of an outdoor sensor

Simple control according to outdoor conditions

The flow temperature is obtained from the composite outdoor temperature on the basis of the cooling characteristic.

This type of control requires the cooling curve to be properly adjusted, as the control does not take the room temperature into account for this adjustment.

Control according to outdoor conditions with room influence

The difference between the room temperature and the setpoint value is measured and taken into account for temperature control. This enables taking into account possible heat inputs and ensures a more accurate room temperature control. Thus the differences with the room temperature are taken into account and the room temperature becomes more stable. The influence of the difference is defined as a percentage. The better the installation in the reference room (accurate room temperature, correct installation location, etc.) the higher will be the value that can be set.

Example:

- Approx 60%: the reference room is appropriate
- Approx 20%: the reference room is inappropriate

Activation of the function requires taking into account the following requirements:

- A room sensor must imperatively be connected.
- The "room influence" parameter must be set between 1 and 99.
- The reference room (where the room sensor is installed) must not contain adjusted thermostatic valves. Any thermostatic valves present in the rooms must be fully open.

Control according to room temperature only

The flow temperature is adjusted according to the room temperature setpoint, the current room temperature and its evolution. A slight increase in room temperature, for example, causes an immediate drop in the flow temperature.

Activation of the function requires taking into account the following requirements:

- A room sensor must imperatively be connected.
- The "room influence" parameter must be set to 100%.
- The reference room (where the room sensor is installed) must not contain adjusted thermostatic valves. Any thermostatic valves present in the rooms must be fully open.

Room Temperature Limitation

LINE	FUNCTION
932	Room temp limitation

The "room temperature limitation" function enables shutting off the cooling circuit pump if the room temperature falls below the adjusted room temperature setpoint (with summer compensation line 920) by more than the adjusted differential.

The cooling circuit pump is reinitiated as soon as the room temperature rises again above the current room temperature setpoint.

If the room temperature limitation function is active, no cooling demand will be transmitted to production.

The function is deactivated if:

- no room temperature sensor is available
- "Room influence limit." = ---
- "Room influence" (line 928) = --- (simple control according to outdoor conditions)

Mixing Valve Control

LINE	FUNCTION
• 938	Mixing valve decrease
• 941	Actuator running time
• 945	Mixing valve heating mode

- : These parameters are not used in this system.

Dewpoint Monitoring

LINE	FUNCTION
• 946	Lock time dewpoint limiter
• 947	Flow temp setpoint increase hygrostat
• 948	Flow setpoint increase start at relative humidity.
• 950	Flow temp differential dewpoint

- : These parameters are not used in this system.

With primary controller/system pump

LINE	FUNCTION
963	With primary controller/system pump (No / Yes)

This setting specifies whether the cooling circuit is supplied from the primary controller or from the primary pump (depending on the installation).

Operating mode changeover

LINE	FUNCTION
969	Operating mode changeover (None / Off / Automatic)

In case of an external change via inputs H2 the operating mode to which the changeover will be performed must be previously defined.

Information:

The extension module is only applicable for a swimming pool to this system. This parameter must be defined on " Off ".

● Domestic hot water functions

The control sets the DHW temperature, according to the time program or continuously, to the desired setpoint. The priority of DHW charging over room heating is adjustable in this case

The controller has a configurable legionella function designed for protection against legionella in the storage tank and the pipes. The circulation pump is controlled according to the current time program and operating mode.

Setpoint value

LINE	FUNCTION
1610	Nominal setpoint
1612	Reduced setpoint

The DHW is heated to various setpoint values. These setpoints are active according to the selected

operating mode and allow the desired temperatures to be reached in the DHW storage tank.

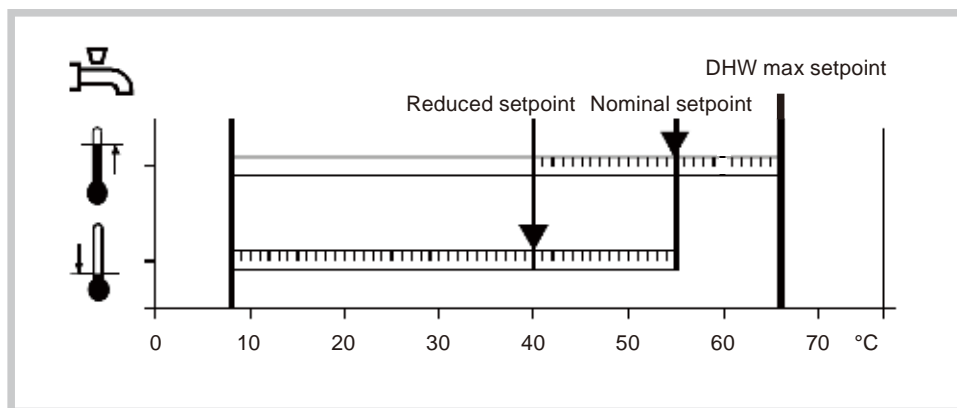

Important:

For optimal operation we recommend reducing the setpoints to the lowest value. Setpoints which are too high may interfere with heating and cause some discomfort. In this case DHW/Heating changeover cycles may successively occur.

If DHW charge boosting is not desired during the day, we recommend adjusting the reduced temperature setpoint to 15°C. Full charging will occur during the night at the nominal temperature.

Release

LINE	FUNCTION
1620	Release (24h/day / Time programs HCs / Time program 4/DHW / Low-tariff / Time program 4/DHW or low-tariff)

24h/day

(Not recommended)

Regardless of the time programs, the temperature of the domestic hot water is continuously maintained at the DHW nominal setpoint temperature.

Example:

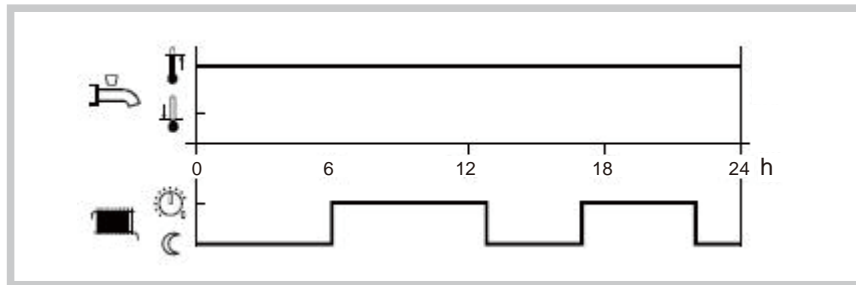

Time program HCs

(Not recommended)

Depending on the heating circuit time programs, the DHW setpoint is changed between the DHW temperature nominal setpoint and the DHW

temperature reduced setpoint. The first switch-on point of each phase is advanced by one hour each time.

Example:

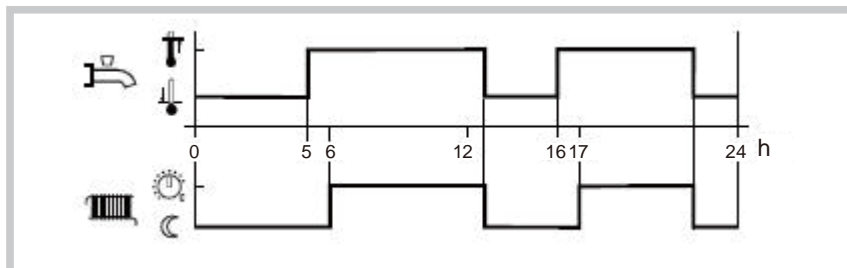

Time program 4 / DHW

(Recommended)

Time program 4 of the local controller is taken into account for the DHW mode. The changeover between DHW nominal setpoint and DHW reduced

setpoint occurs on the changeover times of this program. Thus, domestic hot water charging takes place independently from the heating circuit.

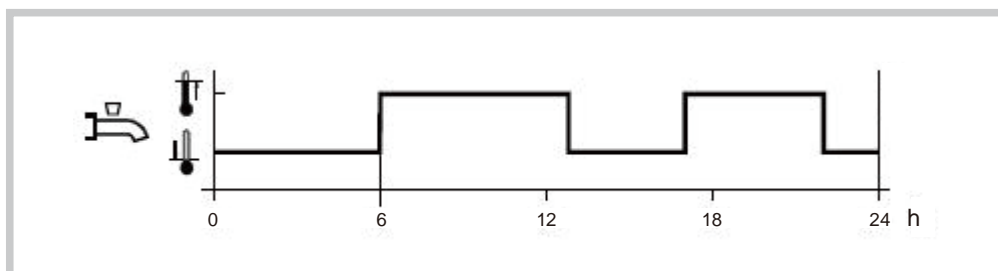

Low-tariff

Released when the low tariff input is active (Input EX5).

Time program 4/DHW or low-tariff

Released when DHW program is set to "Nominal" or if the low tariff input is active.

DHW mode	Holiday status	Release (line 1620)	Time program status (Program 4)	Low-tariff status (EX5)	DHW mode level
Off	x	x	x	x	Frost protection
On	Yes	x	x	x	Frost protection
On	No	x	...
On	No	Low-tariff (OPK)	x	Inactive	Reduced
On	No	Low-tariff (OPK)	x	Active	Nominal
On	No	Time program 4 or OPK	Nominal	Inactive	Nominal
On	No	Time program 4 or OPK	Reduced	Inactive	Reduced
On	No	Time program 4 or OPK	Nominal	Active	Nominal
On	No	Time program 4 or OPK	Reduced	Active	Nominal

x = N/A

Information:

Release by low tariff input always triggers forced DHW charging.

If the low tariff input EX5 has not been configured and release via OPK has nevertheless been set, the DHW level will either continuously remain on reduced or will follow time program 4.

Legionella Function

LINE	FUNCTION
1640	Legionella function
1641	Legionella function periodically
1642	Legionella function weekday
1644	Legionella function time
1645	Legionella function setpoint
1646	Legionella function duration
1647	Legionella function circulation pump

Legionella function

• periodically

The legionella function occurs repeatedly according to the adjusted periodicity (line 1641).

• Fixed weekday

The legionella function can be activated on a fixed day of the week (line 1642). With this setting, heating up to the legionella setpoint occurs on the scheduled day of the week, regardless of the storage tank temperatures during the previous period.

Legionella function circulation pump

The DHW circulation pump can be activated during the period of time the legionella function is performed.

Important:

During the period of time legionella function is carried out, there is a risk of scalding when opening the taps.

Circulating Pump

LINE	FUNCTION
1660	Circulating pump release

Circulating pump release

The "DHW release" setting switches on the circulation pump when DHW production is released.

● Swimming pool functions

LINE	FUNCTION
2056	Setpoint source heating

The controller enables a swimming pool to be heated by the heat pump. An individual setpoint can be set by means of line 2056, which appears when the swimming pool function is activated by "Function input H2" (line 6046) being set to "Release swimming pool".

Use of input H2 requires an extension module to be connected to the control.

● Heat pump functions

LINE	FUNCTION
2844	Switch-off temp max
2882	Release integral electric flow
2884	Release electric flow below OT
2910	Release above OT
2920	With electrical utility lock

Switch-off temp max

If the flow or the return temperature exceeds the maximum switch off temperature, the compressor will be switched off.

Release integral electric flow

After the release of the 1st stage (heater 1: on, heater 2: off), the controller compares the temperature measured with the point of engagement and forms an integral and includes a possible deficit of heat. Once the value of the integral reaches the maximum value (line 2882), the 2nd stage is engaged (heater 1: off, heater 2: on). The controller continuously compares the temperature measured at the point of engagement and new features to the deficit of heat in the full release. When the full release reaches the value set (line 2882), the 3rd stage of the heater is triggered (heater 1: on, heater 2: on).

Release electric flow below OT

The heater will be activated only if the attenuated outdoor temperature is below the temperature set here.

Warning:

This setting is too low, there may be a feeling of discomfort due to the fact that the heat pump is unable to meet the heating requirements alone at low outdoor temperatures, and heaters are not switched on.

Release above OT

The heat pump is released only when the composite outdoor temperature lies above the value set here. Below this outdoor temperature level, the amount of heat required must be delivered by some other heat source.

With electrical utility lock

This setting relates to input EX4 (load-shedding or peak day clearing) and allows the electric heaters to be locked as follows:

• **Locked**

The heat pump and all electric heaters are locked, both heat pump stages and the DHW tank electric heater.

Only the boiler backup, if installed, continues to operate.

• **Released**

The heat pump operates and all electric heaters are locked, both heat pump stages and the DHW tank electric heater.

The boiler backup, if installed, continues to operate.

● DHW storage tank functions

DHW charging at the nominal setpoint temperature (line 1610) always takes place in two stages. In the first stage, only the heating pump heats the DHW tank.

The power supplied during this time is at its peak. Then, when the heat pump is no longer able to

supply enough heat to reach the setpoint value, it switches on the DHW tank heater if authorised. The heater will be cut off when charging is complete. While the DHW tank charging process via the electric heater is finishing, the heat pump resumes heating.

Charging Control

LINE	FUNCTION
5020	Flow setpoint boost
5024	Switching differential
5030	Charging time limitation

Flow setpoint boost

The DHW demand to the generator is comprised of the current DHW setpoint plus the adjustable setpoint boost.

Switching differential

If the DHW temperature is lower than the current setpoint minus the differential set here, the DHW charging process is launched.

It ends when the temperature reaches the current setpoint.

Information:

Forced charging is triggered on the first DHW release of the day.

Charging is also launched when the DHW temperature is within the differential, and as long as it is not less than 1K above the setpoint.

Charging time limitation

During charging, the room heating (depending on the charging priority defined on (line 1630) and on the hydraulic circuit) may be stopped or insufficient. Therefore it is often advisable to limit the charging process timewise to enable heating.

If "- -" has been selected the charging time limitation will be deactivated. The DHW will be heated to the nominal setpoint, even if the room heating has not received enough power in the meantime.

If a value between 10 and 600 is selected, charging will be suspended after the time period set in minutes, and will remain suspended over that time before resuming. The generator power remains available in the meantime to heat the room. This cycle is repeated until the DHW nominal setpoint has been reached.

Information:

When the room heating is stopped (summer mode, economy function, etc.), DHW charging remains active, regardless of the setting.

Heater

LINE	FUNCTION
5060	Electric immersion heater operating mode
5061	Electric immersion heater release

Electric immersion heater operating mode

• Substitute

The heater performs DHW charging as soon as the heat pump is stopped or becomes inoperative, or if the heat pump has finished charging without reaching the setpoint.

The DHW tank heater switch-on point is calculated so as to optimize the changeover level.

If the DHW temperature falls below the current setpoint (line 1610 or 1612) minus the differential (line 5024) the heat pump will resume operation.

• Summer

When all heating circuits change to summer mode, the heater performs DHW charging starting on the next day. The heat pump therefore stays off in summer mode.

Production of DHW by the heat pump will resume only if at least one heating circuit changes over to

heating mode. In that case, the heater operating mode is the same as described in the "Substitute" setting.

• Always

DHW charging is always carried out by means of the heater.

• Cooling mode

When the heat pump operates in cooling mode, it is possible to specify whether a DHW charging is to be carried out via the heater, without cooling being interrupted.

The DHW is prepared by the heater, if the heat pump is in cooling mode or is not available (e.g. out of order).

Information:

The DHW mode selection key also acts on the heater. In order for DHW charging to take place, the DHW key must be on.

Electric immersion heater release

• 24h/day

The heater is continuously active regardless of time programs.

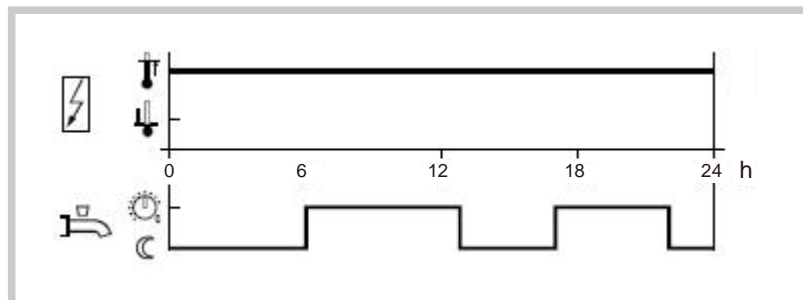

• DHW release

The heater is controlled according to "DHW release".

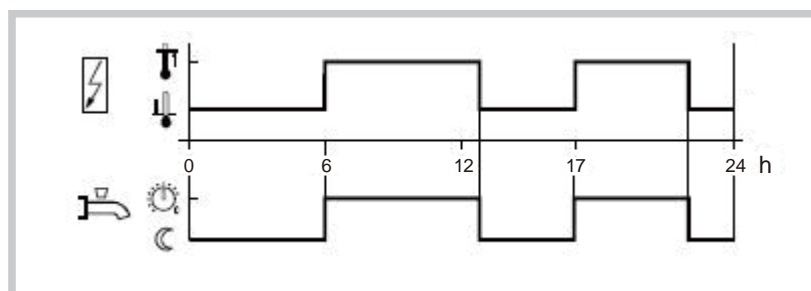

- **Time program 4/DHW**

Time program 4/DHW of the local controller is taken into account for the heater.

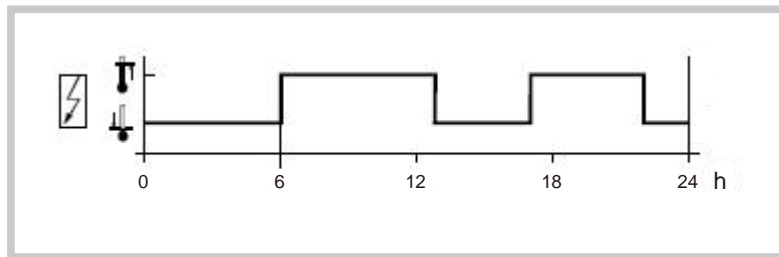

Information:

Switch-on will actually be in effect only if the heater is able to operate according to the "heater operating mode" setting.

● Configuration functions

When an installation is started up, the hydraulic diagram presetting for that installation must be entered.

Presettings

LINE	FUNCTION
5700	Presetting

Cooling Circuit 1

LINE	FUNCTION
5711	Cooling circuit 1 (Off / 4-pipe system / 2-pipe system)

- **Off**

The cooling circuit is deactivated.

- **4-pipe system**

Not compatible with this system.

This setting relates to passive cooling.

- **2-pipe system**

Activates the heat pump cooling mode.

Information:

Switching on the cooling mode causes the menu "Cooling circuit 1" to appear.

Combination storage tank

LINE	FUNCTION
5870	Combination storage tank

Contact type input EX

LINE	FUNCTION
5987	Contact type input EX4
5989	Contact type input EX5

Input H2 Function

Input H2 is available only on the control extension module.

LINE	FUNCTION
6046	Function input H2
6047	Contact type H2
6048	Function value contact H2

Function input H2

- **Operating mode changes**
- **Error/alarm message**
- **Dewpoint monitor**

These options are not applicable to this system.

- **Release swimming pool**

This function enables the swimming pool to be directly heated with the boiler and pump H2 via an external device (e.g. manual switch).

Direct charging always requires release on input H2.

For configuration: set input H2 to "Swimming pool release" and wire the contact.

Contact type H2

- **Normally-closed**

The contact is normally closed and must be open to activate the selected H2 function.

- **Normally-open**

The contact is normally open and must be closed to activate the selected H2 function.

Function value Contact H2

The function value contact H2 is operated only when the parameter 6046 is setting on "release swimming pool". This function allows to set the temperature of the water which goes on the swimming pool heat exchanger.

Sensor Corrections

LINE	FUNCTION
6100	Readjustm outside sensor

The outdoor temperature measuring value can be corrected within a range of +/- 3 K.

Installation Frost Protection

LINE	FUNCTION
6120	Frost protection plant

According to the outdoor temperature, the heating circuit pump and the condenser pump are switched on although there is no demand for heat.

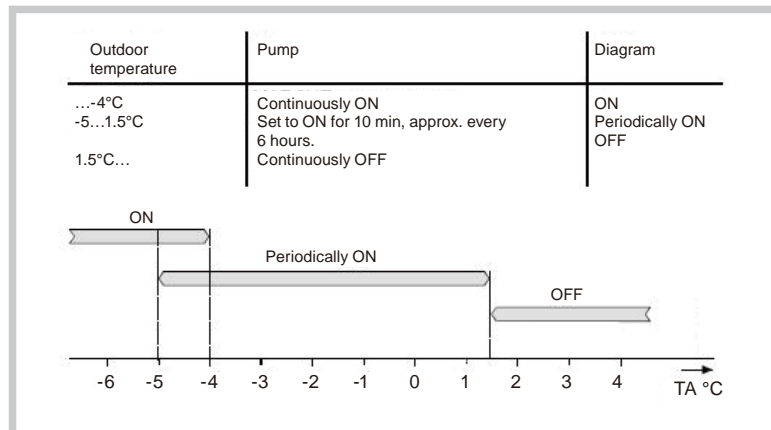

Miscellaneous

LINE	FUNCTION
6205	Reset to default parameters
6220	Software version (heat pump regulator)

Reset to default parameters

All parameters can be reset to factory settings, except followings: Time and date, User interface, and all time programs, as well as the operating hours and the various counters.

Software version (heat pump regulator)

The software version represents the controller software status at the time the unit is being produced. It is printed on the back of the unit. The first two digits represent the software version, and the third is the revision number (e.g. 01.0)

● Fault functions

When a fault occurs, the symbol  appears and it is possible to display an error message in the Info

section by pressing the Info key. The display shows what caused the fault.

Reset (unlock) Heat Pump

LINE	FUNCTION
6711	Reset HP

This line is used to clear the heat pump error messages. The predetermined switch-on delay in case of a failure is therefore ignored, which avoids waiting periods during servicing / troubleshooting.

This option should not be used in normal operating conditions.

Fault Indication Function

LINE	FUNCTION
6740	Flow temp 1 alarm
6741	Flow temp 2 alarm
6745	DHW charging alarm
6746	Flow temp cooling 1 alarm

The difference between the setpoint value and the current temperature value is monitored.

Any difference which continues after the set time period has elapsed will trigger an error message.

Fault History

LINE	FUNCTION
6800 to 6818	Time stamp and history of faults 1 -10

The controller saves the last 10 faults which have occurred to a non volatile memory. Any new entry

will delete the oldest entry from the memory. A fault code and a time are saved for each fault.

Error Code List:

- Designation of error:
The error designations in the table below are displayed in plain text on the user interface.
- Location:
The sensor or contact associated to the error message.
- Reset:
Reset is either automatic or manual, depending on the type of error (see table below with error messages).
- Manual reset:
Errors which are displayed in the Info section and accompanied by the "Reset " question can be manually reset. Press the "OK" key once, "yes" flashes on the display. Press the "OK" key again to confirm the "yes" and the error will be reset.
- Automatic reset:
Automatic clearing occurs after a previously set time (OEM setting) has elapsed. After this time out (6 hours by default) has elapsed, the controller will attempt to reset the error.
If "Number" appears in the table, it is possible to define how many times the fault can be reset before the heat pump is declared out of order.
- Heat pump operation:
Shows whether or not the heat pump can continue to operate when the error occurs.
 - Yes:
The heat pump continues to operate despite the error message.
 - No:
The error interrupts operation of the heat pump.
 - No with glycol water:
This error stops glycol water heat pumps, but does not prevent operation of water or air heat pumps.
 - No with water:
This error stops water heat pumps, but does not prevent operation of glycol water heat pumps.
 - No with air:
This error stops air heat pumps, but does not prevent operation of water heat pumps or glycol water heat pumps.
 - Per diagram:
The heat pump will be stopped according to the current installation diagram.
- Priority:
Errors are ranked by priority. From priority 5 onward (i.e. priority levels 5 - 9) the alarm messages used in remote control are sent. In addition, the alarm relay is switched on.

Table of error messages which can be displayed:

No. Designation of error	Location	Reset		HP operation	Priority
		Manual	Automatic		
0: No fault					
10: Outdoor sensor	B9	No	No	Yes	6
30: Flow sensor 1	B1	No	No	Yes	6
31: Cooling flow sensor 1	B16	No	No	Yes	6
32: Flow sensor 2	B12	No	No	Yes	6
33: Heat pump flow temp sensor error	B21	No	No	Yes	6
44: Heat pump return temp sensor error	B71	No	No	Per diagram	6
50: DHW temp sensor 1	B3	No	No	Yes	6
60: Room sensor 1		No	No	Yes	6
65: Room sensor 2		No	No	Yes	6
76: Special sensor 1	BX	No	No	Yes	3
83: BSB wire short-circuit		No	No	Yes	8
84: BSB, address collision		No	No	Yes	3
85: Radio communication error		No	No	Yes	8
98: Extension module 1		No	No	Yes	8
99: Extension module 2		No	No	Yes	8
100: 2 master clocks on bus		No	No	Yes	3
102: Clock without running supply		No	No	Yes	3
105: Maintenance message		No	No	Yes	5
121: HC1 flow temp too low		No	No	Yes	6
122: HC2 flow temp too low		No	No	Yes	6
126: DHW charge monitoring		No	No	Yes	6
127: Anti-legionella temperature		No	No	Yes	6
134: Heat pump alarm summary	E20	Yes	Number*	No	9
138: No heat pump control sensor		No	Yes	No	1
146: Sensor / Control device configuration		No	No	Yes	3
171: Alarm contact 1 activated		No	No	Yes	6
172: Alarm contact 2 activated	H2	No	No	Yes	6
176: Hydraulic pressure 2 too high	H2	No	No	Yes	6
177: Hydraulic pressure 2 too low	H2	No	No	No	6
178: HC1 safety thermostat		No	No	Yes	3
179: HC2 safety thermostat		No	No	Yes	3
201: Frost alarm	B21/71	Yes	No	No	9
243: Swimming pool sensor	B13	No	No	Yes	6
325: BX/Ext unit: same sensors		No	No	Yes	3
327: Ext modules: same functions		No	No	Yes	3
329: Ext modules/Mixing grp: same functions		No	No	Yes	3
330: BX1 no function		No	No	Yes	3
331: BX2 no function		No	No	Yes	3
332: BX3 no function		No	No	Yes	3
333: BX4 no function		No	No	Yes	3
334: BX5 no function		No	No	Yes	3
335: BX21 no function		No	No	Yes	3
336: BX22 no function		No	No	Yes	3
357: cooling circuit flow temp not reached		No	No	Yes	6

No. Designation of error	Location	Reset		HP operation	Priority
		Manual	Automatic		
359: no cooling valve Y21		No	No	Yes	3
360: no process reversing valve Y22		No	No	Yes	3
364: Heat pump cooling system error		No	No	Yes	3
369: External fault				No	
370: Heat pump fault				No	

*: If such statuses or events occur for the first time, they will not directly generate a fault message, but only a status message.

Only if the anomaly occurs repeatedly over a predefined time period and at a given frequency (number) will an error message be generated.

● Service / special operation functions

Maintenance

Maintenance functions can be used as a preventive step for periodically monitoring the installation. All maintenance functions can be individually activated / deactivated.

The controller automatically generates maintenance messages if the settings defined are either exceeded or fail to be reached.

LINE	FUNCTION
7070	HP interval
7071	HP time since maintenance
7072	Max starts compressor 1/hrs run
7073	Cur starts compressor 1/hrs run
7076	Differential condenser max/week
7077	Cur differential condenser max/week
7078	Differential condenser min/week
7079	Cur differential condenser min/week
7090	DHW storage tank interval
7091	DHW storage tank since maintenance

HP interval

Defines the maintenance frequency (in months) for the heat pump.

HP time since maintenance

Displays the time (in months) elapsed since the last maintenance. If the value exceeds the "heat pump interval" (line 7070), the symbol  will be displayed and a maintenance message will appear in the Info section:

17: Heat pump maintenance Interval (Priority 6)

This setting can be reset with the associated rights of access.

Max starts compressor 1/hrs run

Defines the maximum number of compressor 1 startups per hour of operation.

Cur starts compressor 1/hrs run

The average number of compressor startups per hour of operation, obtained over a period of 6 weeks.

If the value exceeds the "Comp1 max startups/hr op" adjusted setting, the symbol  will be displayed and a maintenance message will appear in the Info section:

8: Too many compressor 1 startups (Priority 9)

This setting can be reset with the associated rights of access.

Differential condenser max/week

Indicates how many times over 7 days the maximum temperature difference on the condenser can be exceeded.

Cur differential condenser max/week

Number of times the maximum temperature difference on the condenser has been exceeded during a 7-day period. If the value exceeds the setting "Max cond diff/week" (line 7076), the symbol will be displayed and a maintenance message will appear in the Info section:

13: Max cond diff (Priority 3)

This setting can be reset with the associated rights of access.

Differential condenser min/week

Indicates how many times over 7 days the minimum temperature difference on the condenser may fail to be reached.

Cur differential condenser min/week

The number of times the minimum temperature difference on the condenser has not been reached over a 7 period. If the value is higher than the setting "Min cond diff/wk" the symbol  will be displayed and a maintenance message will appear in the Info section:

14: Min cond diff (Priority 3)

This setting can be reset with the associated rights of access.

DHW storage tank interval

Defines the maintenance frequency (in months) for the DHW tank.

DHW storage tank since maintenance

Displays the time (in month) elapsed since the last maintenance. If the value exceeds the "DHW tank interval" (line 7090), this symbol  will be displayed and a maintenance message will appear in the Info section:

11: DHW tank period (Priority 6)

Emergency mode

If the heat pump is not operating properly, an emergency operation can be maintained. The emergency operation enables the installation to be

run with the available heaters (flow, DHW tank). In this case the compressor will remain off.

LINE	FUNCTION
7141	Emergency operation
7142	Emergency operation function type

Emergency operation

Emergency operation can be activated and deactivated manually.

- **Off**

Emergency operation is deactivated.

- **On**

Emergency operation is activated.

Emergency operation function type

- **Manually**

Emergency operation can be activated/deactivated only through the Emergency operation setting on line 7141.

- **Automatically**

As soon as a fault occurs on the heat pump, emergency operation is automatically switched on. It stops when the fault is removed and, if necessary, cleared (reset). Emergency operation may however be activated / deactivated manually via the "Emergency operation" setting on line 7141.

Simulation

LINE	FUNCTION
7150	Simulation outside temp

Simulation outside temp

To make the starting-up and troubleshooting processes easier, it is possible to simulate an outdoor temperature in the range of -50...+50°C. During simulation, the current, composite and attenuated outdoor temperatures are ignored and substituted with the adjusted simulation temperature.

Computation of the three outdoor temperatures based on the actual outdoor temperature continues to be performed during the simulation, and these temperatures are available again when the simulation is over.

This function can be deactivated by selecting -.- on this line or automatically, after a 5 hour waiting period.

Person in charge

LINE	FUNCTION
7181	Phone no. responsibility 1
7183	Phone no. responsibility 2

These lines are used to specify the telephone numbers associated with the corresponding alarms.

● Input / output test functions

Input/output testing is used to ensure that the connected components are in working order.

Relay Output Testing

Selection of a setting from relay testing closes the corresponding relay and therefore switches on the connected component. This makes it possible to

check that the relays are in working order and that the wiring has been performed correctly.

LINE	FUNCTION
7700	Relay test (No test / Everything off / Relay output QX23 module 1 / Relay output QX21 module 1 / Relay output QX22 module 1 / Relay output QX1 / Relay output QX2 / Relay output QX3 / Relay output QX4 / Relay output QX5 / Relay output QX6 / Relay output QX23 module 2 / Relay output QX21 module 2 / Relay output QX22 module 2 / Relay output QX7)

Warning:

During testing of an output, the heat pump is stopped, all outputs are "off" and only the controlled output is on.

Analog Input/Output Testing

LINE	FUNCTION
7710	Output test UX
7711	Voltage valve UX
7720	Output test digital
7721	Digital output DO1
7722	Digital output DO2

Output test UX

Enables testing the outdoor unit control.

Output test digital

Enables testing outputs DO1 and DO2

Voltage valve UX

Displays the voltage value at the UX output.

Digital output DOx

Shows the output status.

Sensor Input Testing

LINE	FUNCTION
7730	Outside temp B9
7820	Sensor temp BX1
7823	Sensor temp BX4
7824	Sensor temp BX5
7830	Sensor temp BX21 module 1
7831	Sensor temp BX22 module 1
7832	Sensor temp BX21 module 2
7833	Sensor temp BX22 module 2

Displays the temperature of each sensor.

H1, H2, H3 Input Testing

LINE	FUNCTION
7841	Contact state H1
7846	Contact state H2
7855	Contact state H3

Displays the current status of contact Hx.

Input Testing

LINE	FUNCTION
7914	Input EX4
7915	Input EX5
7916	Input EX6

If a test setting is selected, the associated input is displayed and can thus be checked. The "0 V" display means that there is no voltage and that the respective input is currently inactive. The

"230 V" display indicates that a 230 V voltage is present on the associated input and therefore, that the input is active.

● State functions

The current operating status of the installation can be viewed by means of status displays.

Messages

LINE	FUNCTION
8000	State heating circuit 1
8001	State heating circuit 2
8003	State DHW
8004	State cooling circuit 1
8006	State heat pump
8011	State swimming pool
8022	State supplementary source

State heating circuit

End user (Info level)	Commissioning, Engineer
Thermostat response	Thermostat response
Manual action active	Manual action active
Controlled drying active	Controlled drying active
Heating mode restriction	Overheating protection active Restriction, boiler protection Restriction, DHW priority Restriction, storage tank
Forced draft	Forced draft, storage tank Forced draft, DHW Forced draft generator Forced draft Switch-off delay active
Comfort heating mode	Optimis. at switch-on + accelerated heating Optimization at switch-on Accelerated heating Comfort heating mode
Reduced heating mode	Optimization at switch-off Reduced heating mode
Frost protection active	Room frost protection Flow frost protection active Install. frost protection active
Summer mode	Summer mode
Off	Eco day active Reduced decrease Frost protection decrease Room temperature limitation Off

State DHW

End user (Info level)	Commissioning, Engineer
Thermostat response	Thermostat response
Manual action active	Manual action active
Draw-off mode	Draw-off mode
Adiabatic cooling active	Adiabatic cooling by collector Adiabatic cooling via gen/HC
Charging lock active	Discharge protection active Charging duration limit. active Charging locked
Forced charging active	Forcing, DHW tank max temp Forcing, max charging temp Forcing, anti-legion. setpoint Forcing, comfort setpoint
Charging by heater	Charging by heater, anti-legion. setpoint Charging by heater, comfort setpoint Charging by heater, reduced setpoint Charging by heater, frost protection setpoint Heater released
Accelerated charging active	Flow active Anti-legion. accelerated charging
Charging active	Charging, anti-legion. setpoint Charging, comfort setpoint Charging, reduced setpoint
Frost protection active	Frost protection active
Switch-off delay active	Switch-off delay active
Charging on standby	Charging on standby
Charged	Charged, max tank temp Charged, max charging temp Charged, anti-legionella temp Charged, nominal temp Charged, reduced temp
Off	Off
Ready	Ready

State cooling circuit 1

End user (Info level)	Commissioning, Engineer
Dewpoint sensor activated	Dewpoint sensor activated
Manual action active	Manual action active
Fault	Fault
Frost protection active	Flow frost protection active
Cooling mode locked	Locked, heating mode Lock time after heating Locked, generator Locked, storage tank
Cooling mode restricted	Flow temp setpoint increase by hygrostat Dewpoint flow min limit Outdoor temp flow min limit
Comfort cooling mode	Comfort cooling mode Switch-off delay active
Cooling protection mode	Cooling protection mode
Frost protection active	Frost protection active
OT cooling limit activated	OT cooling limit activated
Off	Off Room temperature limitation Flow limit reached
Cooling mode off	Cooling mode deactivated

State heat pump

End user (Info level)	Commissioning, Engineer
Emergency mode	Emergency mode
Fault	Fault
Locked	Locked, outdoor temperature Locked, external Locked, economy mode
Lim. time active	Consumer flow rate controller Min outdoor temp use limit Max outdoor temp use limit Max switch off temp lim Max OT limit cooling Min switch off temp limit Comp min switch off time active Excess heat compensation
Frost protection active	Heat pump frost protection
Defrosting activated	Defrosting activated
Cooling mode active	Comp min ON time active Comp 1 ON
Heating	Comp min ON time active Heat deficiency compensation Max cond diff limit Min cond diff limit Comp.1 and heater ON Comp 1 ON Heater ON
Frost protection active	Install. frost protection active
Off	Flow active Switch-off delay active No demand

State swimming pool

End user (Info level)	Commissioning, Engineer
Manual action active	Manual action active
Fault	Fault
Heating mode restriction	Heating mode restriction
Forced draft	Forced draft
Heating	Generator heating mode
Heated, max pool temp	Heated, max pool temp Heated, generator setpoint
Heated	
Heating off	Solar heating mode OFF Generator heating mode OFF
Cooling	Cooling

State supplementary source

End user (Info level)	Commissioning, Engineer
Locked	Locked, solid fuel boiler Locked, outside temperature Locked, economy mode
In operation for HC, DHW	In operation for HC, DHW
Released for HC, DHW	Released for HC, DHW
In operation for DHW	In operation for DHW
Released for DHW	Released for DHW
In operation for heating circuit	In operation for heating circuit
In operation for HC, DHW	In operation for HC, DHW
Released for HC, DHW	Released for HC, DHW
In operation for DHW	In operation for DHW
Released for DHW	Released for DHW
In operation for heating circuit	In operation for heating circuit
Released for HC	Released for HC
Overrun active	Overrun active
Off.	Off.

History

LINE	FUNCTION
8050 to 8068	Timestamping and history status coding of faults 1-10

The last 10 status messages are saved and displayed with the associated codes. The most recent message is saved to History 1, the oldest to History 10.

Information:

Status displays for the end user can be viewed directly in the Info section on the room unit.

● Diagnostics heat generation functions

Various setpoints and actual values, relay switch status data can be displayed for purposes of diagnosis.

Heat Pump

LINE	FUNCTION
8402	Electric immersion heater 1 flow
8403	Electric immersion heater 2 flow
8406	Condenser pump

These lines are used to check the operating mode of the components controlled by the heat pump relays. The display "0" means that the associated components are currently disconnected. The display "1" means that the associated components are currently switched on.

Information:

This information applies to relays defined as normally open contacts. For normally closed contacts, the action is reversed.

Setpoints and Measured Values

LINE	FUNCTION
8410	Return temp HP
8412	Flow temp HP
8413	Compressor modulation
8425	Temp differential condenser

These lines allow the various setpoints and measured values for the heat pump to be viewed.

Hour / Startup Counter

LINE	FUNCTION
8454	Locking time HP
8455	Counter number of locks HP
8456	Hours run electric flow
8457	Start counter electric flow

Locking time HP

Displays the cumulative locking time since start-up by the electrical services (via EX6).

Counter number of locks HP

Displays the cumulative locks since start-up by the electrical services (via EX6).

Hours run electric flow, Start counter electric flow

These lines are used to view the hours of operation and the number of start-up of electric heater.

● Diagnostics consumers functions

Various setpoints and actual values, relay switch status and timing status data can be displayed for purposes of diagnosis.

Outside Temperatures

LINE	FUNCTION
8700	Outside temp
8701	Outside temp min
8702	Outside temp max
8703	Outside temp attenuated
8704	Outside temp composite

The current, minimum, maximum, attenuated and composite outdoor temperatures are displayed.

Heating Circuits

LINE	FUNCTION
8730	heating circuit pump 1
8731	Heating circuit mix valve 1 open
8732	Heating circuit mix valve 1 close
8740	Room temp 1
8743	Flow temp 1

The display "Off" means that the associated components are currently disconnected.
The display "On" means that the associated components are currently switched on.

Cooling Circuit

LINE	FUNCTION
8756	Flow temp cooling 1

The actual value of the cooling mode are displayed.

The cooling mode room setpoint is displayed on programming line 8741.

Domestic Hot Water

LINE	FUNCTION
8820	DHW pump
8821	Electric immersion heater DHW
8830	DHW temp 1
8840	Hours run DHW pump
8841	Start counter DHW pump
8842	Hours run electric heater DHW
8843	Start counter electric heater DHW

The measured values, the DHW circulation pump and charging temperature, operating hour and start-up counters are displayed, as well as

temperatures of the primary controllers and DHW heater.

Swimming Pool

LINE	FUNCTION
8900	Swimming pool temp

The current temperature of the swimming pool is displayed.

Line

LINE	FUNCTION
8950	Common flow temp

Multifunction Relay Status

LINE	FUNCTION
9031	Relay output QX1
9032	Relay output QX2
9033	Relay output QX3
9034	Relay output QX4
9035	Relay output QX5
9036	Relay output QX6
9037	Relay output QX7

The switching status of multifunction relays 1 - 6 can be viewed individually on these lines. The display "Off" means that the components assigned to this

output are currently disconnected. The display "On" means that the associated components are currently switched on.

Status of Relays for Extension Modules 1 and 2

LINE	FUNCTION
9050	Relay output QX21 module 1
9051	Relay output QX22 module 1
9052	Relay output QX23 module 1
9053	Relay output QX21 module 2
9054	Relay output QX22 module 2
9055	Relay output QX23 module 2

The switching status of the relays connected to extension modules 1 and 2 can be viewed on these lines.

The display "Off" means that the components assigned to this output are currently disconnected. The display "On" means that the associated components are currently switched on.

3. ELECTRICAL CONNECTIONS

3-1. OVERVIEW OF ALL THE ELECTRICAL CONNECTIONS

The wiring diagram for the control box is shown in detail on electrical wiring diagrams (Chapter 1 for monobloc unit).

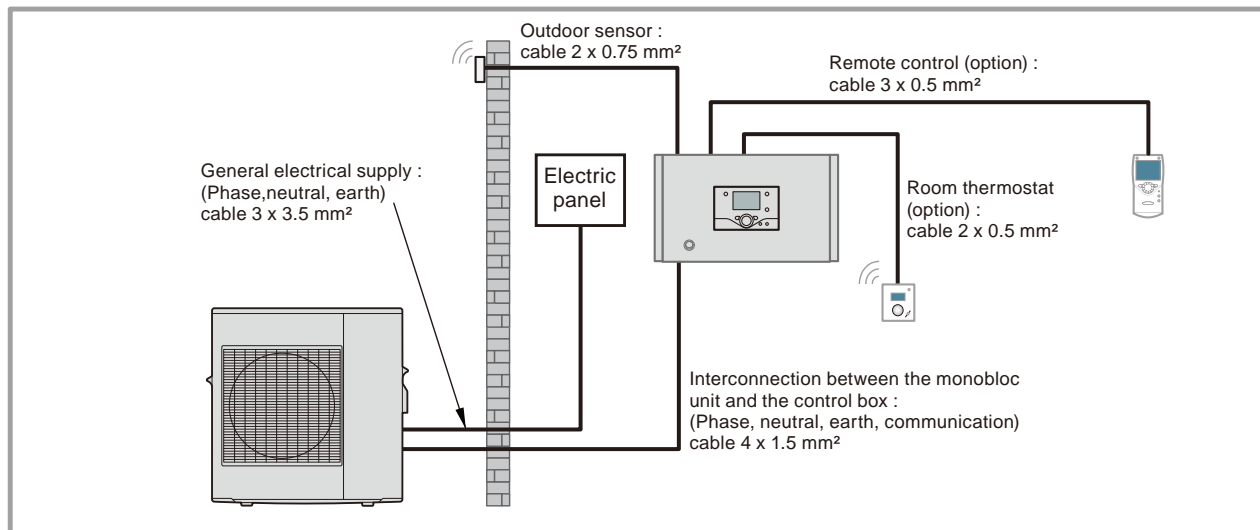

Overall layout of the electrical connections for a simple installation

3-2. ELECTRICAL CONNECTIONS ON THE CONTROL BOX

- **Make the connections in accordance with the diagram.**

Connect the interconnection cable between terminal 1, 2, 3 and 4 (earth) of the control box and the terminals 1, 2, 3 and earth of the monobloc unit.

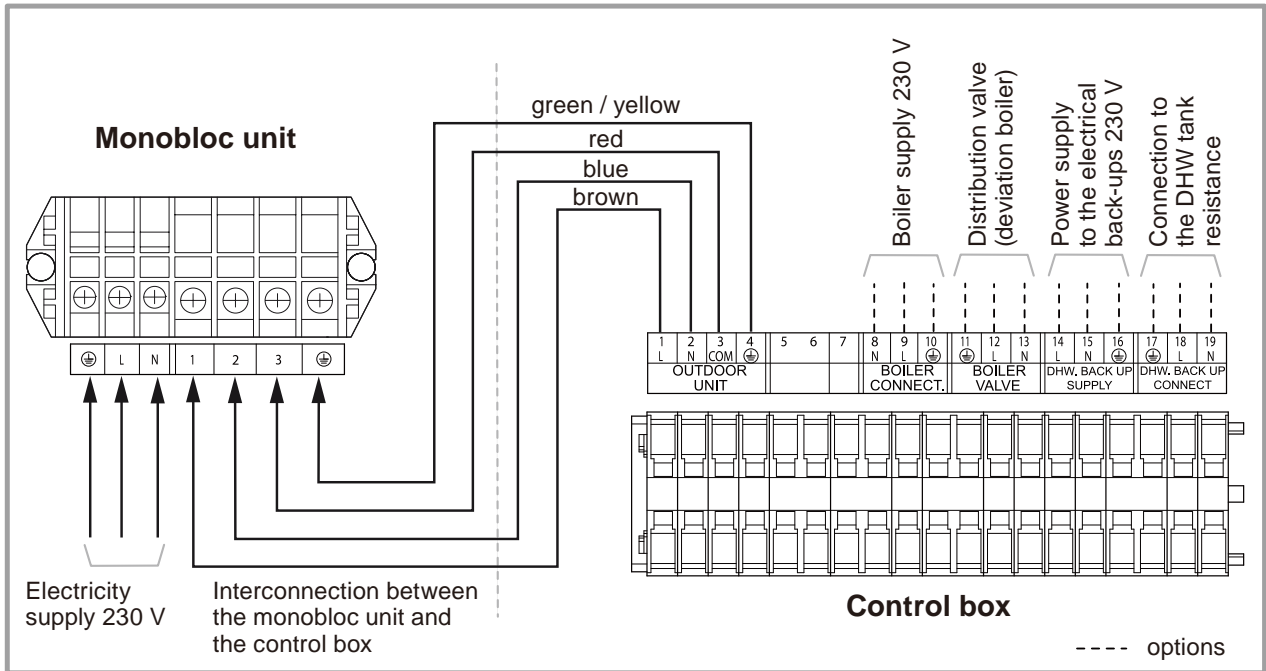

Connection to terminals

Note:

Ensure that the general electrical power supply has been cut off before starting any repair work.
The rearmament of safety thermostat should be done by a professional.

• **Interconnection between the monobloc unit and the control box**

Comply with the correspondence between the markings on the control box terminal and those on the monobloc unit when connecting the interconnection cables.

A connection error could cause the destruction of one or other of the units.

• **DHW tank with electrical back-up heating (option)**

- Connect the distribution valve to connector QX4, earth and N.
- Connect the domestic water sensor to terminal BX1 and M.
- Connect the DHW back-up to terminals 17 (earth), 18 and 19.
- Connect the back-up electrical supply to terminals 14, 15 and 16 (earth).
- Please refer to the instructions supplied with the DHW kit.
- Please refer to the instructions supplied with the DHW tank.

• **Boiler connection**

- Connect the distribution valve (deviation boiler) to the terminals 11 (earth), 12 and 13.
- Connect the boiler supply to terminals 8, 9 and 10 (earth).
- Please refer to the instructions supplied with the boiler connection kit.
- Please refer to the instructions supplied with the boiler.

• **Floor heating system**

Heated floor thermal safety fuse.

- The installer is responsible for connecting the heated floor's safety system. Thermal safety will stop the heat pump if the temperature in the floor is too high. The heated floor's safety system must cut the electrical supply of the heat pump with a relay.

• **Contract with the power provider**

The heat pump's operation can be controlled to suit special contracts (e.g. off-peak, day/night).

In particular, domestic hot water (DHW) at Nominal temperature will be produced during the off-peak hours when electricity is cheaper.

- Connect the "Power Provider" contact to input EX5.
- Set the parameter line 1620 to "Off-peak hours".
- 230V on input EX5 = "Peak hours" information activated.
(Basic setting / Modification possible line 5989, menu Configuration)

• **Power limitation or EJP (peak day removal)**

Power limitation is intended to reduce electrical consumption when this is too high compared to the contract with the power provider.

- Connect the power limiting device to input EX4, the back-ups for the heat pump and the DHW stop in the event of over-consumption by the dwelling.
- 230 V on input EX4 = power limitation in progress. (Basic setting / Modification possible line 5987, menu Configuration and line 2920, menu Heat pump)

• **External faults the heat pump**

Any component of carryforward of information (thermostat, pressure switch, etc.) may signal an external problem and stop the heat pump.

- Connect the external component to input EX6.
- 230 V on input EX6 = stoppage of heat pump (the system displays Error 369).

3-3. CONNECTIONS TO THE HEAT PUMP REGULATOR (Accessories and options)

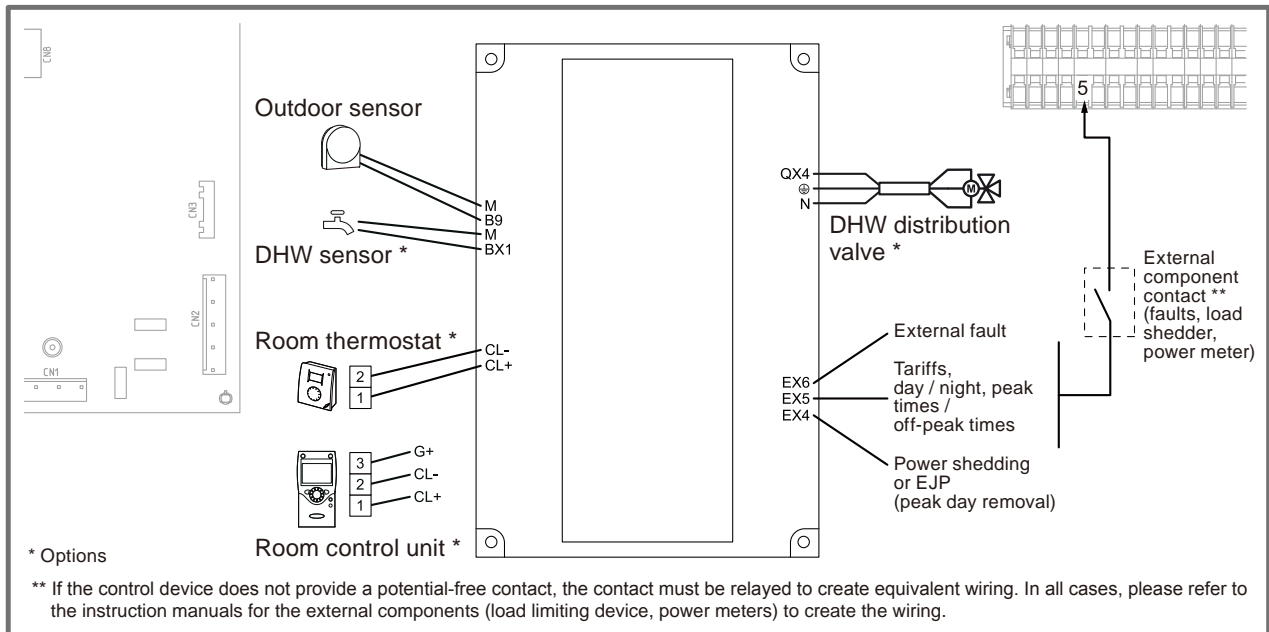

Connections to regulator (accessories and options)

■ OUTDOOR SENSOR

The outdoor sensor is required for the heat pump to operate correctly.

Consult the fitting instructions on the sensor packaging.

Place the sensor on the coldest part, generally the northern or north-eastern side.

In any case, it must not be exposed to the morning sun.

It must be installed so as to be easily accessible but at least 2,5 m from the floor.

It is essential that it avoid any sources of heat such as flues, the upper parts of doors and windows, proximity to extraction vents, the underneath of balconies and under-eave areas which would isolate the sensor from variations in the outdoor air temperature.

- Connect the outdoor sensor to the M and B9 terminals on the heat pump control board.

■ ROOM THERMOSTAT AND / OR REMOTE CONTROL

The room thermostat (remote control) is optional.

Consult the fitting instructions on the sensor packaging.

The sensor must be installed in the living room area on a very uncluttered wall, 1,5 m above the floor.

Avoid direct sources of heat (chimney/flue, television, cooking hobs), draughty areas (ventilation, door, etc.).

Air leaks in the seals in the constructions are often translated into cold air blowing through the electrical conduits. Lag the electrical conduits if there is a cold draught on the back of the IR sensor.

- Installation equipped with the room thermostats:

- Connect the sensor to one of the **CL+** or **CL-** terminal.

- Installation equipped with a room thermostat and a remote control:

- Connect the remote control: terminal **CL+** on (1), **CL-** on (2) and **G+** on (3).

■ DHW SENSOR

If the installation is equipped with a DHW tank (with electric back-up):

- Place the domestic hot water sensor in the housing for the cylinder sensors.

- Connect the domestic hot water sensor to terminal BX1 and M.



■ START-UP

- Ensure that the start-up switch of the control box is set to 0.
- Close the installation's main circuit breaker.
On first commissioning (or in winter), in order to allow the compressor to pre-heat, engage the installation's main circuit breaker (power supply to the monobloc unit) some hours before starting up the tests.
- Switch-on the start-up switch of the control box (position 1).
To ensure that inputs EX4, EX5 and EX6 operate correctly : Check that the live-neutral polarity of the electrical supply is correct.
When the power is switched on and every time that the ON/OFF button is switched off and then switched on again, the monobloc unit will take approximately 4 minutes to start up, even if the setting is requesting heating.

During the regulator initialisation phase, the display shows all the symbols and then "Data update" and then "State heat pump".

- Make all the specific adjustments to the setting (configuring the installation).

- Press the key 

- Hold down the key  for 3s and select the level of access used with the aid of the knob .

- Confirm with the key 

Parameter the heat pump's setting (See "■ FUNCTION TABLE of 2-3 CONTROL SETTING").

In case of error 10 (Outdoor sensor), the regulating system uses an average initial outdoor temperature of 0°C and requires some time to update this temperature.

To avoid this situation, the sensor must be connected correctly.

Re-initialise line 8703 (commissioning level, consumer diagnostic menu).

■ CONFIGURING THE ROOM THERMOSTAT

Configure the room thermostat and connect it to the appropriate heating zone:

- Hold down the occupancy key for more than 3 seconds. The room thermostat displays RU and a number flashes.
- Turn the wheel to choose the zone (1).
- Press the occupancy key; the room thermostat displays P1 and a flashing number.
 - 1: Automatic recording : a correction of the setting with the button is adopted without any particular confirmation (timeout) or by pressing the regime key.
 - 2: Recording with confirmation: a correction of the setting with the button is not adopted until the regime key is pressed.
- Press the occupancy key again; the room thermostat displays P2 and a flashing number.
 - 0: OFF : all the operating elements are engaged.
 - 1: ON : the following operating elements are locked:
 - Switching over the heating circuit's operating mode
 - Adjusting the comfort setpoint
 - Changing the operating level (Heating mode key)

The room thermostat displays OFF for 3 seconds when a locked button is pressed.

■ CONFIGURING THE REMOTE CONTROL

During commissioning, after an initialisation period of approx. 3 minutes, the user's language must be set:

- Press the key 
- Choose menu "Operator section".
- Choose "Language".
- Select the language menu (**English**, Français, Nederlands, Español, etc).

4. INSTALLATION

4-1. CONTROL BOX

■ MODEL: UTW-SCB*A

● Access to the control box

- 1: Remove the screw.
- 2: Pull down the front panel forward.

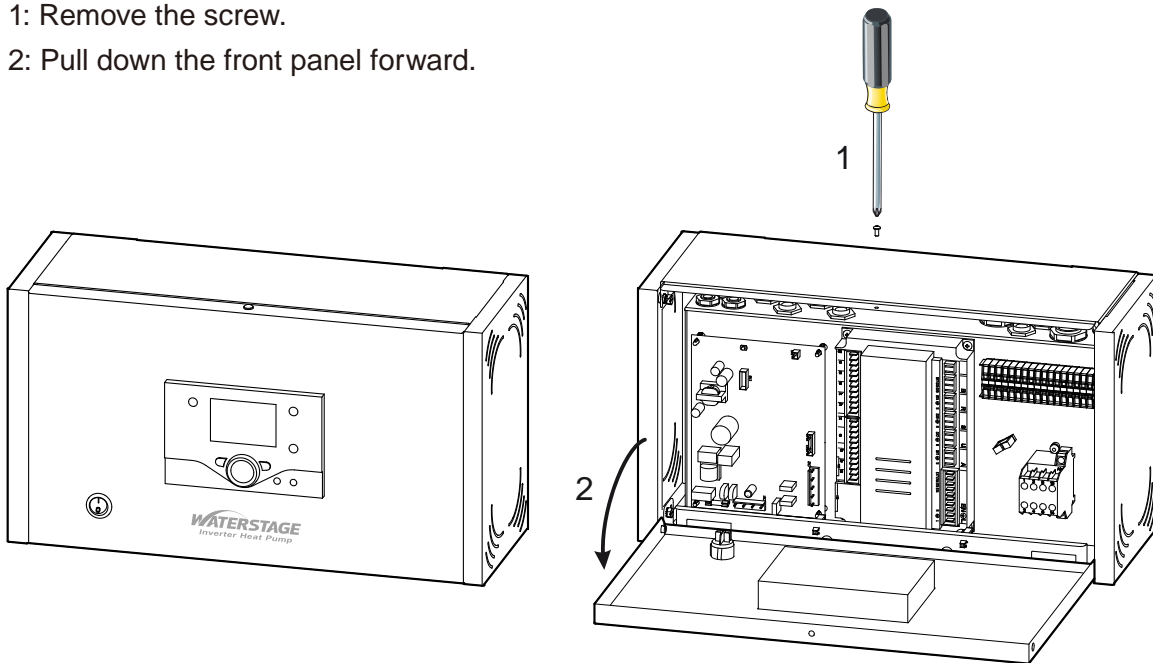

● Installation

- 3: Remove the upper panel.

Install at a place that can withstand the weight of the control box and install positively so that the box will not topple or fall.

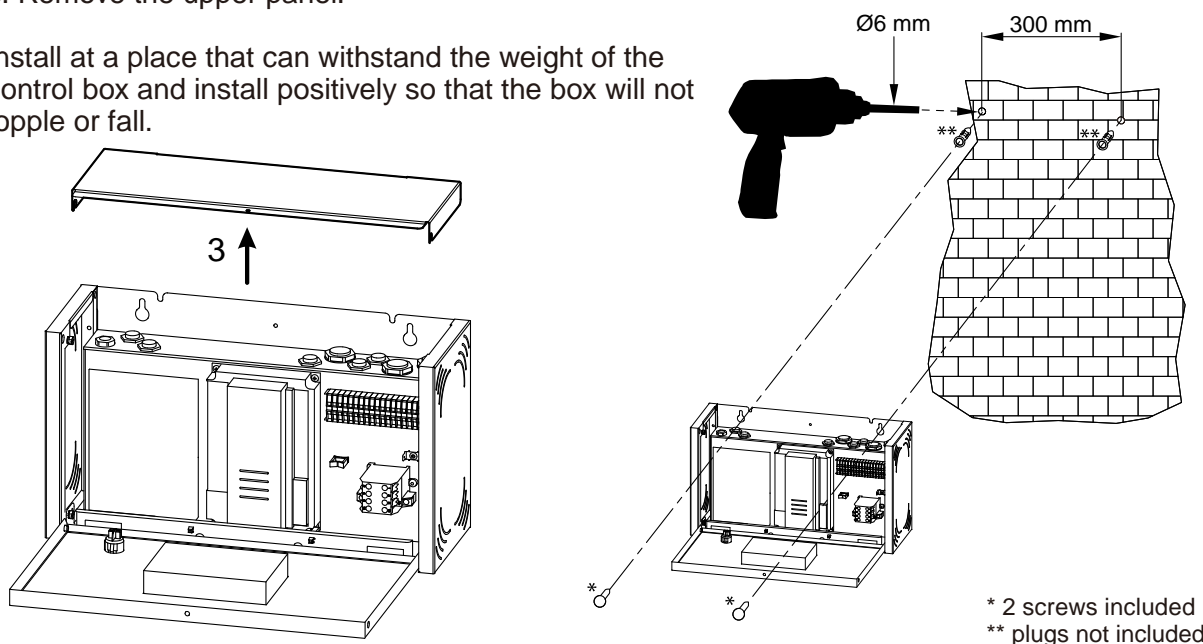

* 2 screws included
** plugs not included

4-2. OUTDOOR SENSOR

■ MODEL: QAC34

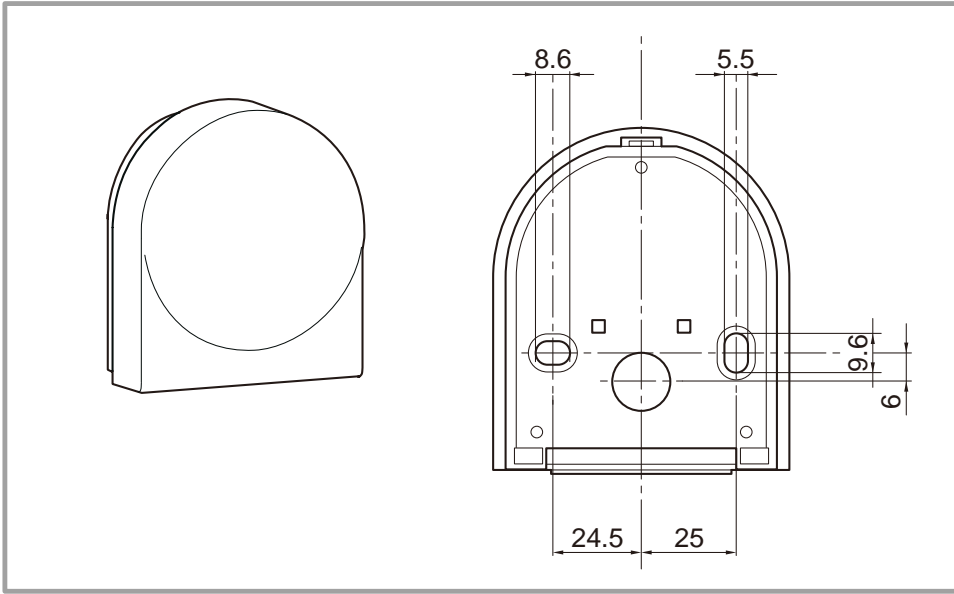

● Installation

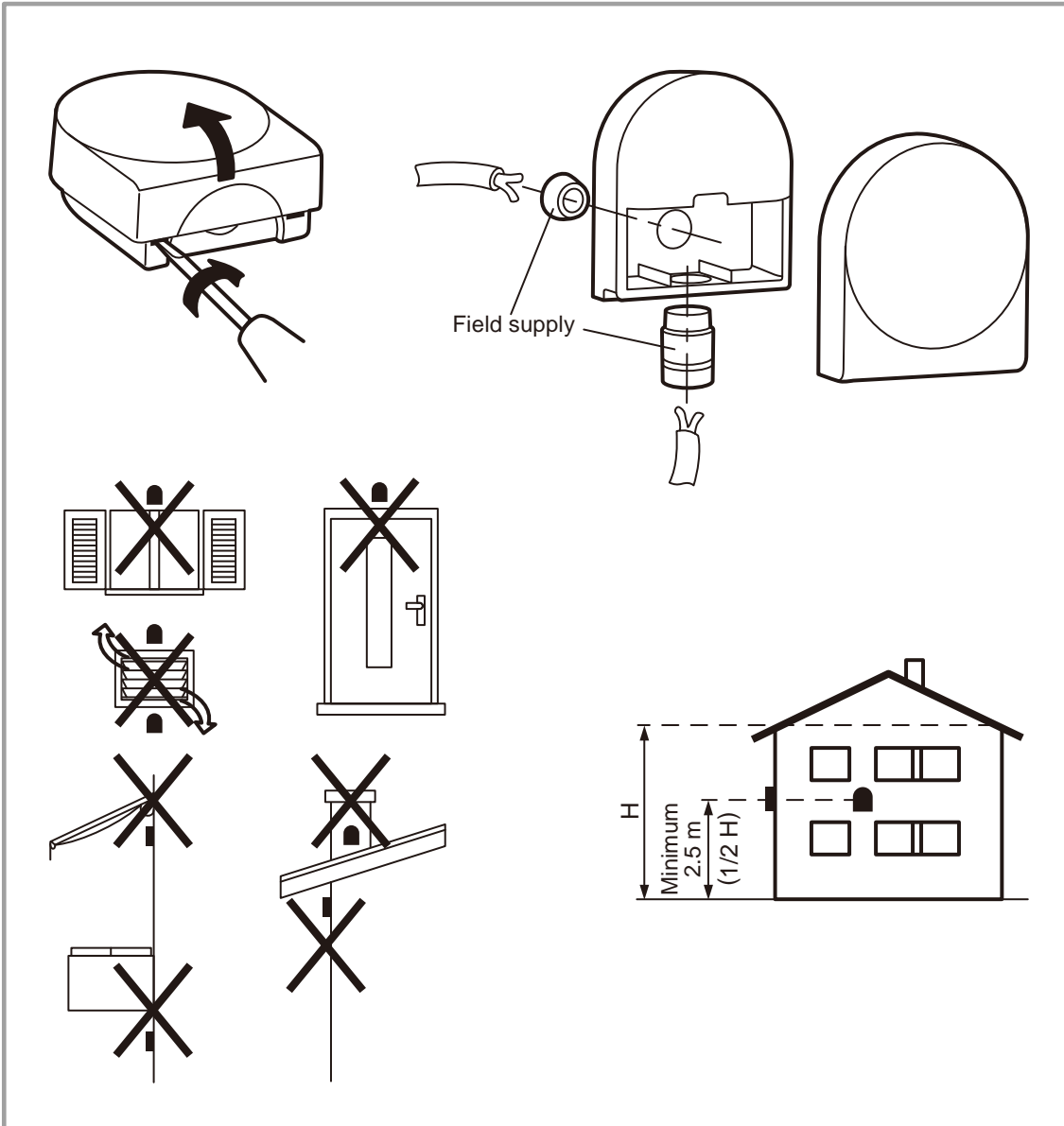

CONTROL SYSTEM

CONTROL SYSTEM

4-3. REMOTE CONTROL (Optional parts)

■ MODEL: UTW-C75XA, UTW-C75XA-E

The remote control includes the functions of the room unit together with those of user interface on the control box.

It can be used, therefore, not only to measure the

room temperature, but also to view the operating status of the heat pump, to enter the heat pump settings.

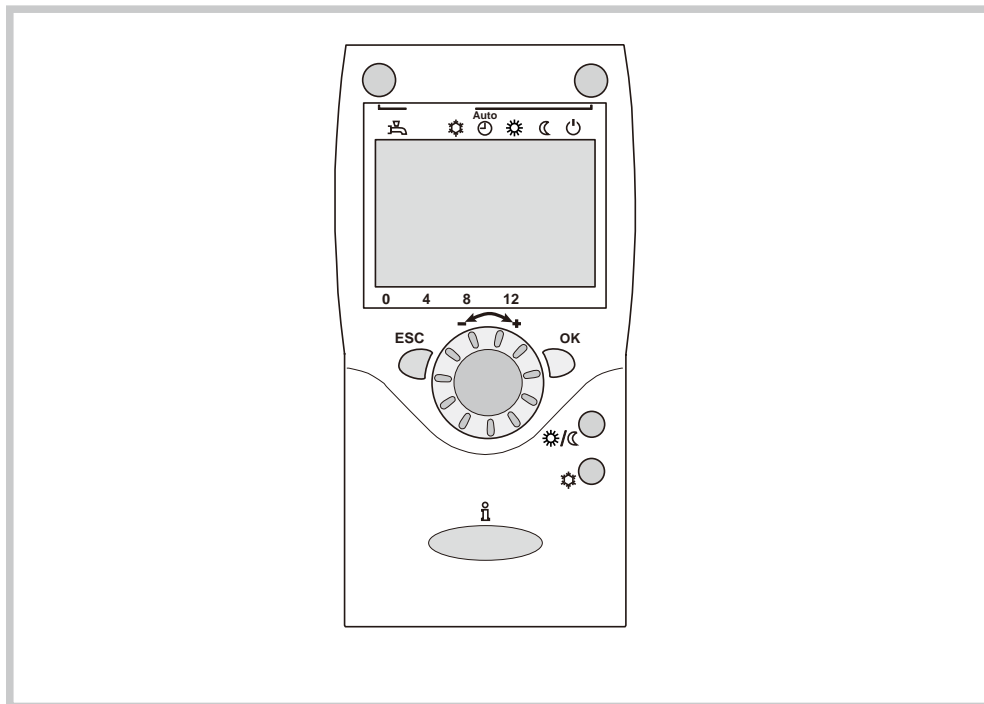

● Installation

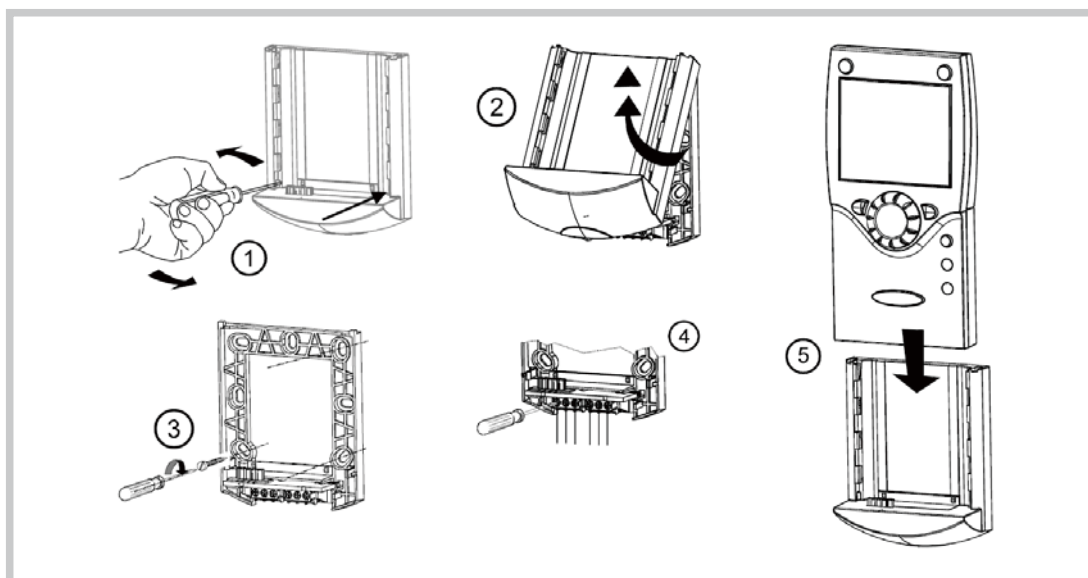

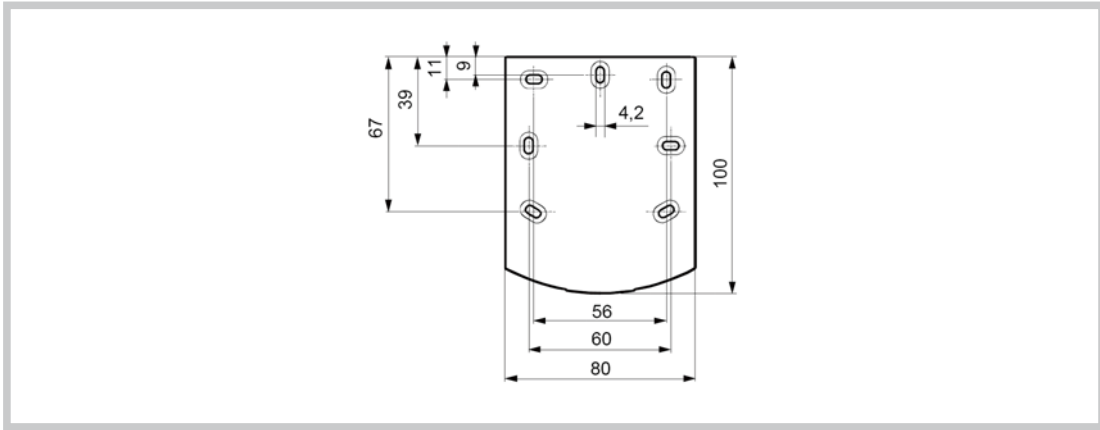

● Connections

The remote control must be connected to terminal b (CL+, CL-, G+) of the heat pump controller board. To do this, you can use a 0.5mm² cable of the two-pair telephone cable type.

If the cable is shielded, the shielding can be connected to the controller CL- terminal. It may under no circumstances be connected on both sides, i.e. heat pump regulator side and room unit side.

Terminal C75	Control terminal	Function
1	CL+	BSB data
2	CL-	BSB ground
3	G+	Power supply DC12V

4-4. ROOM THERMOSTAT (Optional parts)

■ MODEL: UTW-C55XA

The room thermostat is optional. Select an appropriate place for the room thermostat by following these rules:

- Central room
- Installation height, approx. 1.5 m
- Inner wall
- Away from drafts
- Away from direct sunlight
- Do not install the thermostat behind a door or in any other place where it may receive shocks.

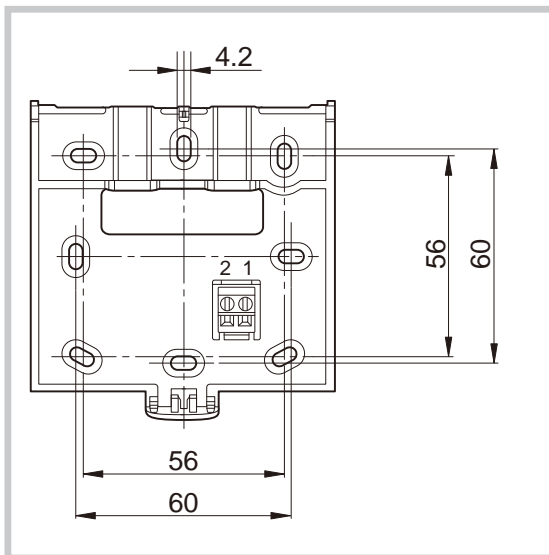
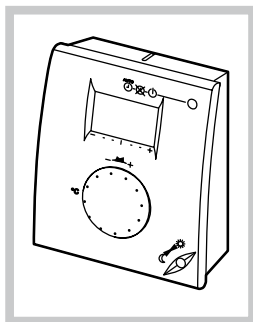

Air tightness faults in buildings often result in cold air being blown through the electrical sheathing.

Do not hesitate to seal them off if a cold air draft comes into the back of the thermostat.

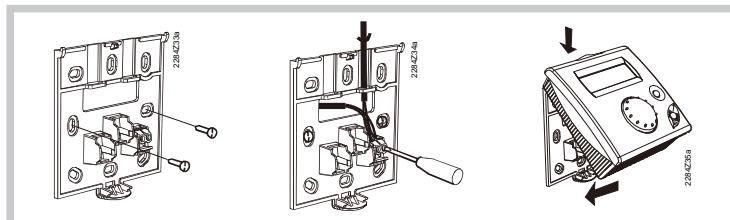

● Connections

The room thermostat must be connected to one of the terminals b (CL+, CL-) of the heat pump controller board. To do this, you can use a 0.5mm² cable of the two-pair telephone cable type. If the cable is shielded, the shielding can be

connected to the controller CL- terminal. It may under no circumstances be connected on both sides, i.e. heat pump regulator side and room thermostat side.

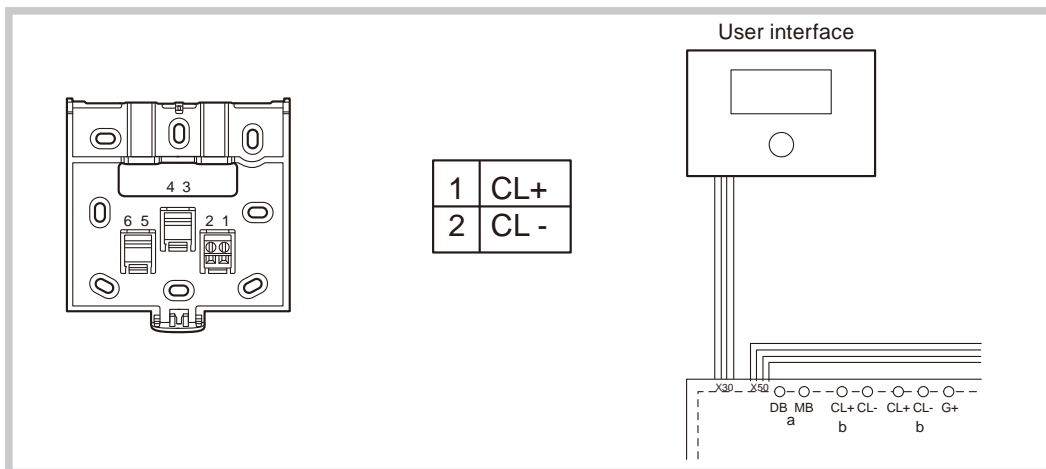

5. DIMENSIONS

5-1. CONTROL BOX

■ MODEL: UTW-SCB*A

(Unit : mm)

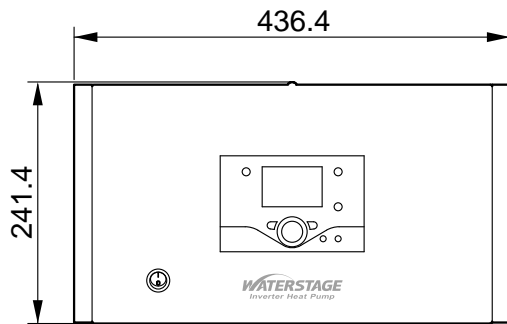

Front view

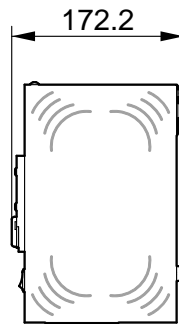

Side view

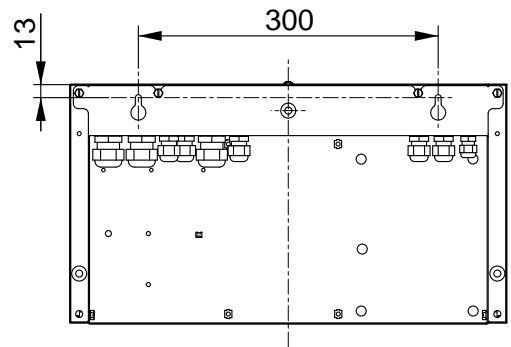

Rear view

5-2. OUTDOOR SENSOR

■ MODEL: QAC34

(Unit : mm)

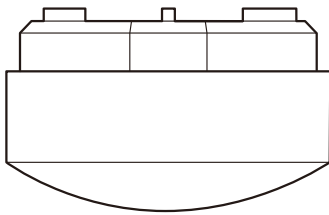

Top view

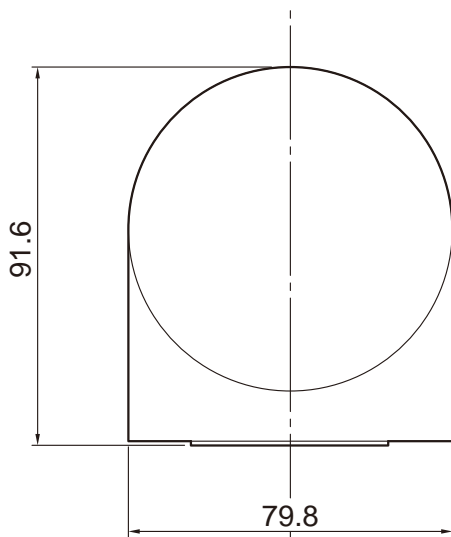

Front view

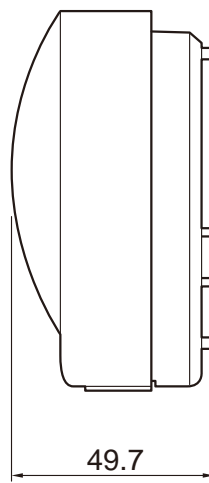

Side view

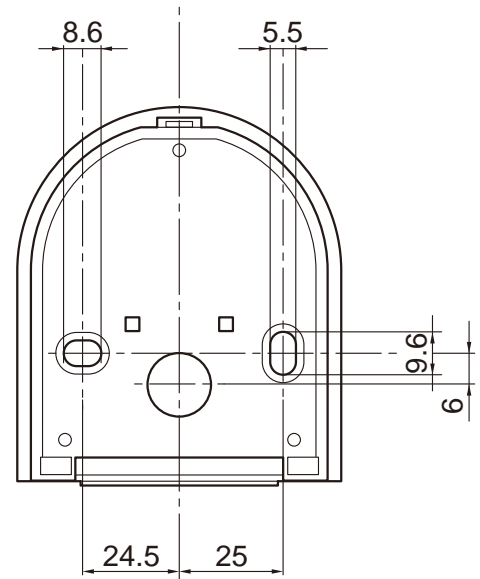

Rear view

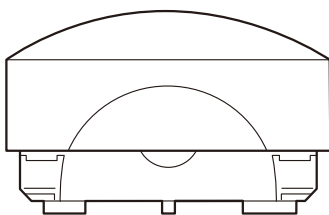

Bottom view

CONTROL
SYSTEM

CONTROL
SYSTEM

5-3. REMOTE CONTROL (Optional parts)

■ MODEL: UTW-C75XA, UTW-C75XA-E

● Controller

(Unit : mm)

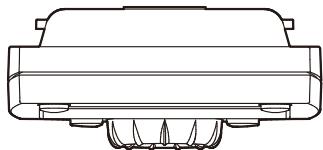

Top view

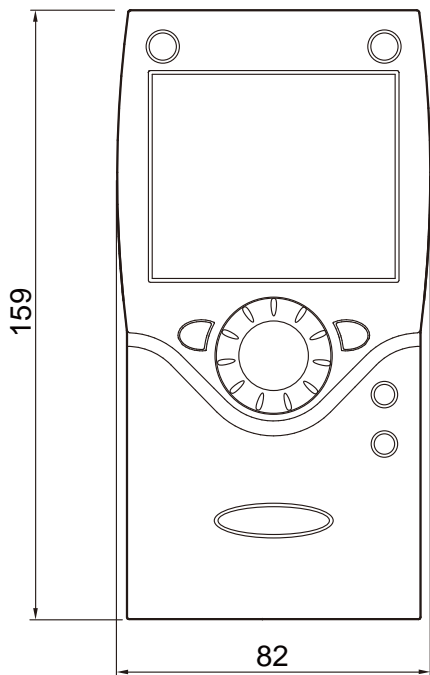

Front view

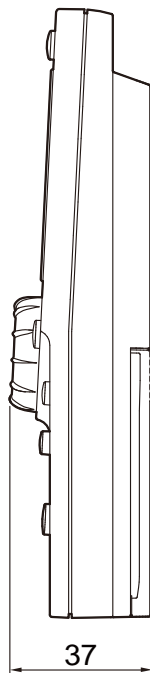

Side view

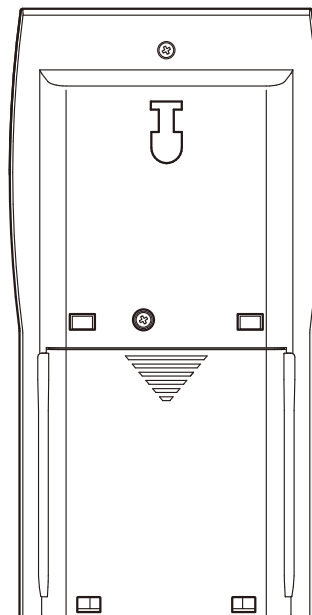

Rear view

● Holder

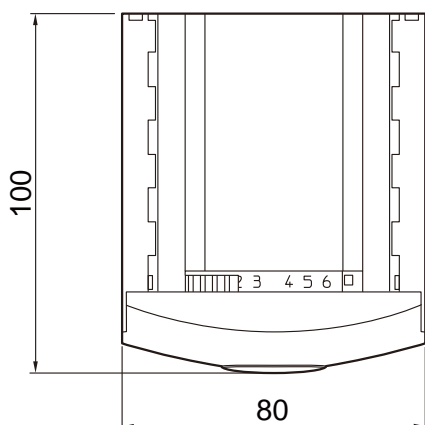

Front view



Side view

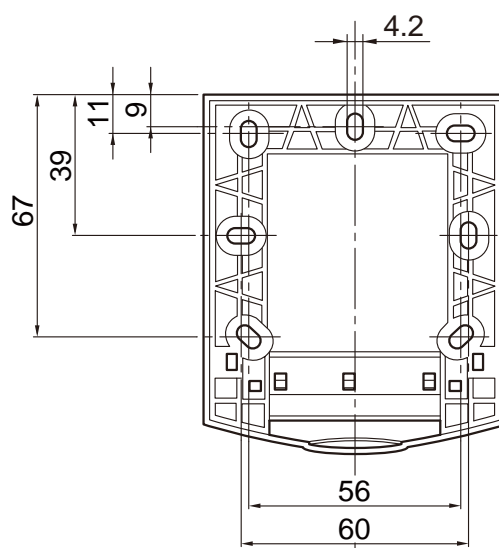

Rear view

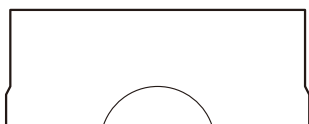

Bottom view

5-4. ROOM THERMOSTAT (Optional parts)

■ MODEL: UTW-C55XA

● Unit

(Unit : mm)

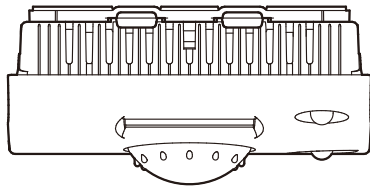

Top view

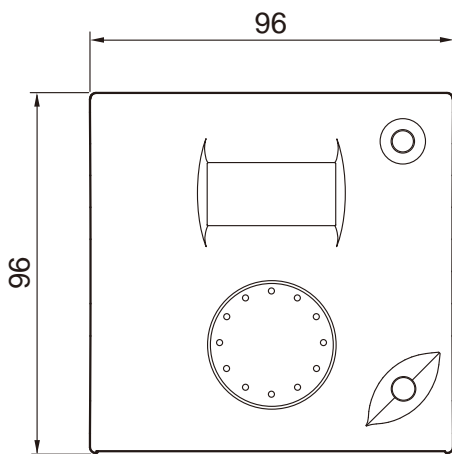

Front view

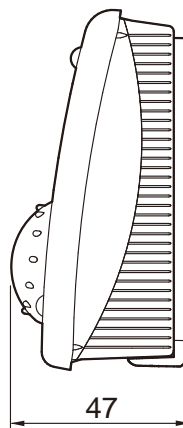

Side view

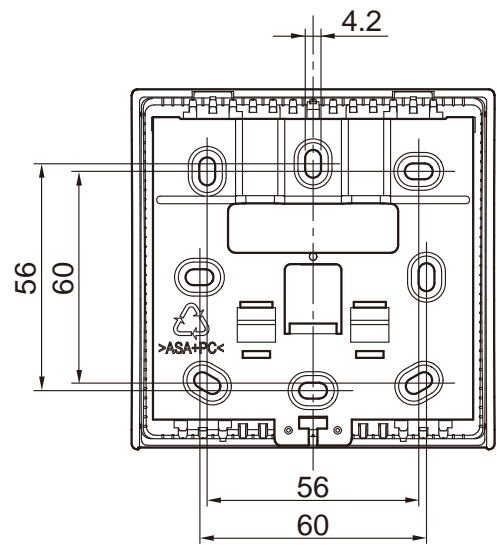

Rear view

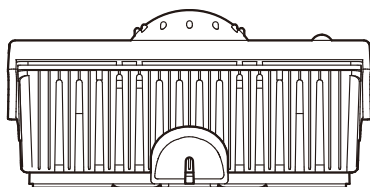





Bottom view

CONTROL SYSTEM

CONTROL SYSTEM

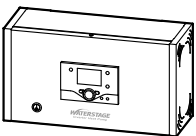

6. PACKING LIST (Accessories)

6-1. CONTROL BOX

Name and shape	Quantity	Application
Control box 	1	Use for ATW operation
Outdoor sensor 	1	For control box connection
Tapping screw (M6 x 70 mm) 	2	For installing the control box
Installation and operating manual 	1	
Operation manual	4	

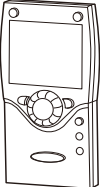
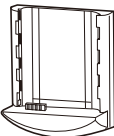

* : If necessary , use shielded cable and tapping screw (Field supplied) in accordance with the standard of the country.

6-2. REMOTE CONTROL (Optional parts)

Name and shape	Quantity	Application
Remote control 	1	Use for ATW operation
Remote control holder 	1	Use as remote control holder
Remote control connector 	1	For remote control connection
Operating instructions 	1	

* : If necessary , use shielded cable and tapping screw (Field supplied) in accordance with the standard of the country.

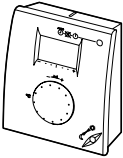
6-3. ROOM THERMOSTAT (Optional parts)

Name and shape	Quantity	Application
Room thermostat 	1	
Room thermostat connector 	1	For room thermostat connection
Operating instructions 	1	

* : If necessary , use shielded cable (Field supplied) in accordance with the standard of the country.

7. WIRING SPECIFICATIONS

7-1. CONTROL BOX

Use	Size	Wire type	Remarks
Control box cable	1.5 mm ²	4 wires connection Max. cable length: 30 m	Use shield cable in accordance with local rules for cable

7-2. OUTDOOR SENSOR

Use	Size	Wire type	Remarks
Outdoor sensor cable	0.75 mm ²	2 wires connection Max. cable length: 60 m	Use shield cable in accordance with local rules for cable

7-3. REMOTE CONTROL (Optional parts)

Use	Size	Wire type	Remarks
Remote control cable	0.5 mm ²	3 wires connection Max. cable length: 200 m	Use shield cable in accordance with local rules for cable

7-4. ROOM THERMOSTAT (Optional parts)

Use	Size	Wire type	Remarks
Room thermostat cable	0.5 mm ²	2 wires connection Max. cable length: 200 m	Use shield cable in accordance with local rules for cable

8. SPECIFICATIONS

8-1. CONTROL BOX

SIZE (H x W x D mm)	241.4 x 436.4 x 172.2
WEIGHT (g)	4600
CABLE LENGTH (m)	30
POWER (V)	230

8-2. OUTDOOR SENSOR

SIZE (H x W x D mm)	91.6 x 79.8 x 49.7
WEIGHT (g)	73
CABLE LENGTH (m)	60

8-3. REMOTE CONTROL (Optional parts)

SIZE (H x W x D mm)	185 x 82 x 42
WEIGHT (g)	170
CABLE LENGTH (m)	200
POWER (V)	12

8-4. ROOM THERMOSTAT (Optional parts)

SIZE (H x W x D mm)	96 x 96 x 47
WEIGHT (g)	115
CABLE LENGTH (m)	Max. 200
POWER (V)	12

WATERSTAGETM

INNOVATIVE SOLUTION OF DOMESTIC HEATING

"***WATERSTAGE***" is a worldwide trademark of FUJITSU GENERAL LIMITED.

Copyright© 2009-2013 Fujitsu General Limited. All rights reserved.

Product specifications are subject to change without notice.

Distributed by :



FUJITSU GENERAL LIMITED

1116, Suenaga, Takatsu-ku, Kawasaki 213-8502, Japan
<http://www.fujitsu-general.com/>