

AIR CONDITIONING



PRODUCT  
CATALOGUE  
2020  
AIR CONDITIONERS  
LINEUP

## FUJITSU GENERAL Way

### Our Mission

---

# Living together for our future

Through innovation and technology, we deliver a brighter future with peace of mind to our customers and societies around the world.

### Our Philosophy

---

#### Act Spontaneously

We embrace new challenges by investing in ourselves for personal growth, and through continuous creativity with a spontaneous attitude.

#### Develop Our Team

We respect and value our people, and optimise their abilities through fostering culture and diversity, and utilising a collaborative effort focused on communication.

#### Value Integrity

To achieve our goals, we always act with integrity and shared ethics.



CONTENTS

**004 OUR MESSAGE**

Innovation and Technology

006 Future

008 Design

010 Quick Service & Maintenance

012 AIRSTAGE™/RAC Support Tool

014 2020 New Products

PRODUCT LINEUP

SPLIT & MULTI-SPLIT

VRF

CONTROL SYSTEM & OPTIONAL PARTS

VENTILATION

# OUR MESSAGE





for Comfort



for Control



**Innovation &  
Globalisation**



for Future



for Design





# Future

## Green Aspect for Refrigerant

We provide reliable technologies approved and cultivated in the European market where environmentally friendly regulations are very strict. We are working on making environmentally friendly products we can be proud of in the future in our research, development and manufacturing processes.

## New refrigerant R32 for the reduction of the global warming potential.

- The ozone-depleting potential (ODP\*) is **0!**
- Environmental properties
- Performance
- Economic efficiency

\*1 **ODP (Ozone-Depleting Potential)**: This is the relative value indicating the impact of ozone-depleting substances per unit weight if they are emitted into the atmosphere when CFC-11 (trichlorofluoromethane, CCl3F) is considered to be 1.0.

\*2 **GWP (Global-Warming Potential)**: This is the number that indicates the global warming capability of other greenhouse gases with reference to carbon dioxide as the standard. This is the estimated integration value, which is indicated as a ratio to CO<sub>2</sub>, of the radiant energy given to the earth (i.e., impact on global warming).

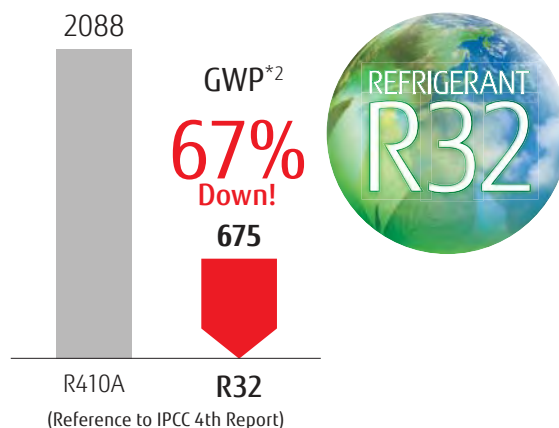

## Our Pioneering Efforts Make A Green Future

Approach to new energy efficiency standard Fujitsu General following the EU climate action plan 20/20/20 by 2020.

### 20% Less Primary Energy Use

Fujitsu General products with high efficiency and therefore low electricity

### 20% Less CO<sub>2</sub> Emissions

Fujitsu General products sharply following the F-gas regulation 517/2014

### 20% Share of Renewable Energy

Fujitsu General promoting air sourced heat pumps as renewable energy source heating systems

## New Energy Labelling Requirement 626/2011/EU

Our Air Conditioners have reached the "Class A" ranking, the highest energy efficiency level that is now shown on energy labels in Europe.

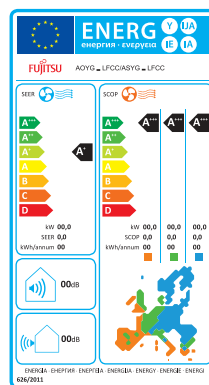

SEER (Cooling mode)	SCOP (Heating mode)
A+++ SEER ≥ 8.50	SCOP ≥ 5.10
A++ 6.10 ≤ SEER < 8.50	4.60 ≤ SCOP < 5.10
A+ 5.60 ≤ SEER < 6.10	4.00 ≤ SCOP < 4.60
A 5.10 ≤ SEER < 5.60	3.40 ≤ SCOP < 4.00
B 4.60 ≤ SEER < 5.10	3.10 ≤ SCOP < 3.40
C 4.10 ≤ SEER < 4.60	2.80 ≤ SCOP < 3.10
D 3.60 ≤ SEER < 4.10	2.50 ≤ SCOP < 2.80
E 3.10 ≤ SEER < 3.60	2.20 ≤ SCOP < 2.50
F 2.60 ≤ SEER < 3.10	1.90 ≤ SCOP < 2.20
G SEER < 2.60	SCOP < 1.90



## Less Space

### Installation Flexibility

The top-class compact dimensions of outdoor units from 8 to 18 HP capacity, keeping the building appearance as it is by improvement on the installation flexibility.

#### Installation Space



#### Weight (18HP model)



## Less Refrigerant

### Design with small refrigerant

Significantly reduce the system refrigerant volume by new small indoor unit, piping design and optimised heat exchanger volume design.

#### System Refrigerant Volume

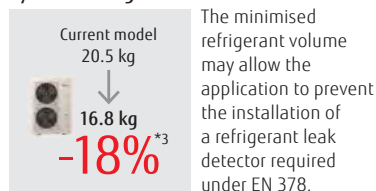

## Less Noise

### Top Class Low Operating Sound

Top class low operating sound is achieved. Highly suited to densely populated areas thanks to their low operating sound.

#### Sound Power Level (8HP model)

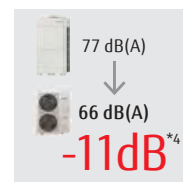

VRF System outdoor units **AIRSTAGE J-IVL**



\*1: J-IV models is compared with V Series outdoor unit 14/16/18 HP models. \*2: J-IV 18 HP model is compared with V-IV 18 HP models. \*3: Ex) In the case of 30 indoor units connection in 1 system (Outdoor unit: 12 HP, Indoor unit: 1 kW × 30, Total piping length: 277.5 m) • J-IV model is compared with current models. \*4: J-IVL 8 HP model is compared with V Series outdoor unit 8 HP model.



# Design

## Beautiful Space Design

Fujitsu General provides the well-designed model with special texture for Europe, the design-award-winning product suitable for the room interiors, and the various designed Cassette type matched to office space. We also have the lineup with elegant design models such as the Ceiling model with beautiful curved surface.



NEW KE Series

## Wall Mounted

KE Designer Series

What we aimed for is a well-designed air conditioner especially for Europe. It is different from the Japanese one, harmonised with its surroundings it envelops a comfortable elegant feeling in the room. Light-elegant and three-dimensional expression composed of curved surface looks beautiful from anywhere.



CMF: Colour Material Finish

The texture of the front panel expresses craftsmanship existing in Europe. The texture changes the expression by the changing light of the day.

## Design Award winning products

Wall Mounted, Design models



NEW

## Light Elegant Design

New Design Ceiling

Light-elegant and three-dimensional expression composed of curved surface gives comfort and wellbeing.



## Various Cassette Design



This fits grid ceiling system.  
Compact Cassette  
Grid type



Beautiful designs from all angles.  
Cassette Circular Flow

# Quick Service & Maintenance

If trouble should occur in a unit or system, abundant support tools such as trouble code display at the product, Service Tool that allows checking of the detailed status of the entire system, and remote monitoring tool that uses the internet, etc. support quick service and maintenance anywhere and at any time.

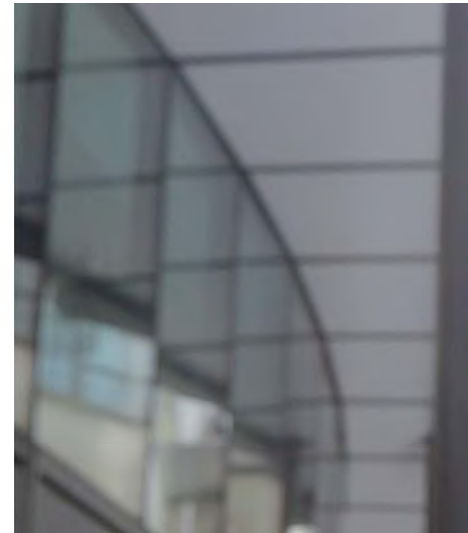

## Easy maintenance & monitoring

### Design for easy maintenance

The air conditioner operating status and error status of that detailed are displayed at the 7-segment of the outdoor unit PCB or on the remote controller screen. The unit status can be checked rapidly allowing for a quick response.

- Operation mode status
- Discharge temperature/Pressure status
- Compressor operation indication
- Address/Type/Number of outdoor unit
- Error code.

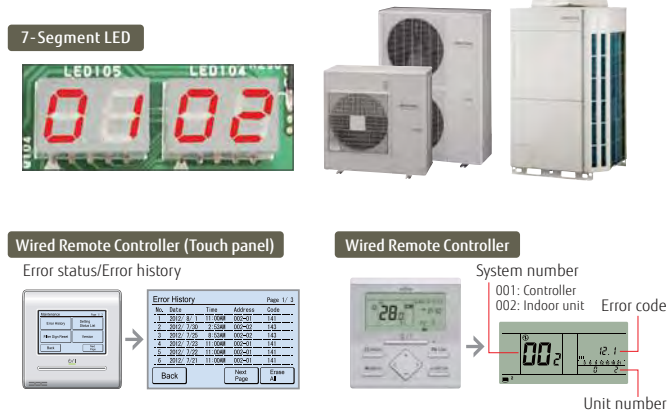

### Error diagnosis by Service Tool

The unit status details from single split models to VRF system can be checked on a PC screen by connecting the Service Tool. Quick countermeasures can be taken

- Operation status/control
- Monitoring operating condition
- Monitoring sensor data
- Indication of trend graph
- Error history
- Indication of refrigerant circuit diagram (For VRF)

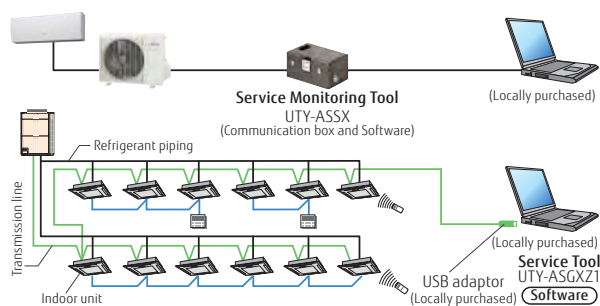

### Remote monitoring

VRF system operating status and trouble status details can be constantly and remotely monitored over the Internet, etc. Rapid cooperation with the service personnel are also possible.

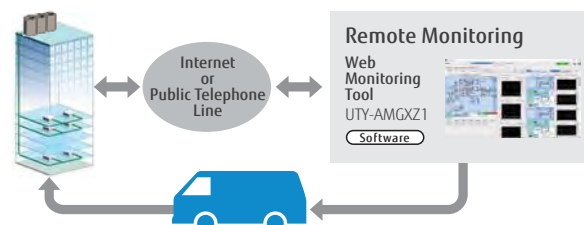



## Mobile Troubleshooting Tool for iPhone & Android

We have released a Troubleshooting Tool App to be used on Android and Apple products. This application is a troubleshooting tool for Fujitsu General air conditioning products (RAC/VRF)

It helps you to check for Error codes, Sensor check, Troubleshooting and to check the condition of the air conditioner.



Mobile Technician **FREE**

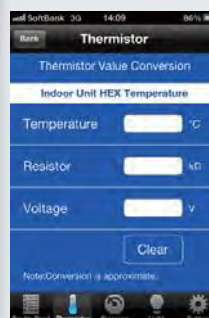

## Service Monitoring Tool for Single Split, Multi-split



- Quick overview about temperature sensor readings and controlled parts like EEV, Fan, Compressor and so on.
- Visualisation of protection operation
- Helpful for intermittent troubleshooting
- Proof of normal operation for the customer during periodical maintenance.



Actual operating condition display

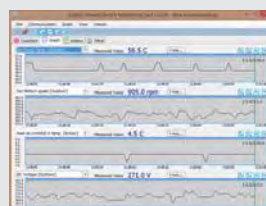

Graph display



Operation history display

	<b>UTY-ASSX</b>
Dimensions (H×W×D) (mm)	60 x 160 x 160
Weight (g)	500

# AIRSTAGE™/RAC Support Tool

Put the charts and pens away and design your projects on your computer with ease using the Design Simulator. Everything from selecting indoor and outdoor units, allocating controls and optional parts to designing the piping and wiring systems is made easier using the program's built-in features.

Once your project is designed take advantage of the Export functions to easily get materials lists, product specifications, refrigerant calculations and more - it'll even export to Word, Excel, or Acrobat formats, and group the relevant CAD data for your project.

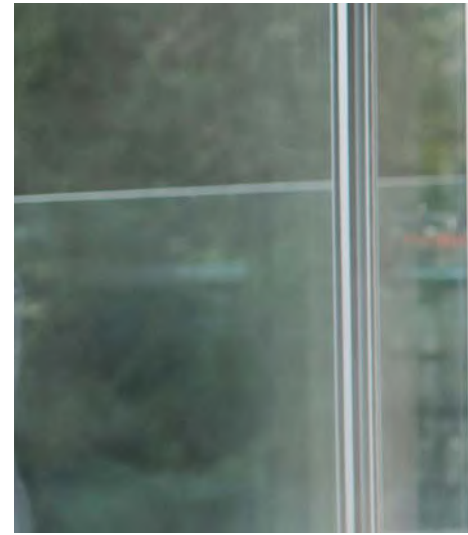

## Design Simulator

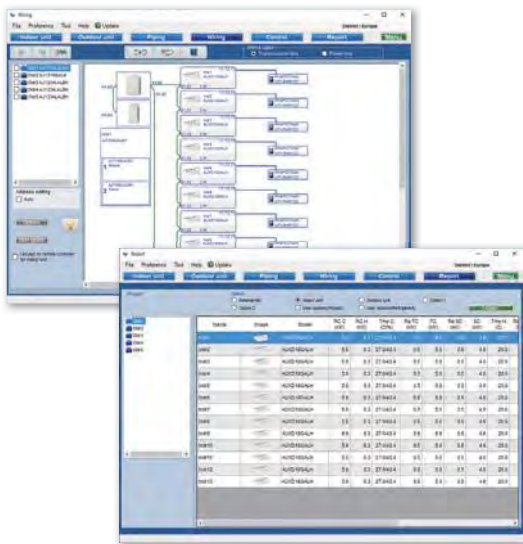

### Automatically create model selection information

- Each unit can be automatically set by entering the required performance, type, and temperature conditions for each indoor unit and then dragging and dropping into the outdoor unit.
- Piping and wiring diagrams can be created automatically and it is easy to set branches, grouping, and options.
- The additional refrigerant charging amount is automatically calculated when the pipe length is entered.
- It is also easy to set the remote controller groups, central controller and converters.
- The equipment list including the equipment information is created automatically.



### Output the format that matches the application

The information specific to your project can be exported in a number of industry standard file formats.

- Word format (rtf)(doc)
- Excel format (csv)
- Acrobat format (pdf)
- Auto CAD format (DXF)
- 2D Data (DXF)
- 3D Data (RFA)

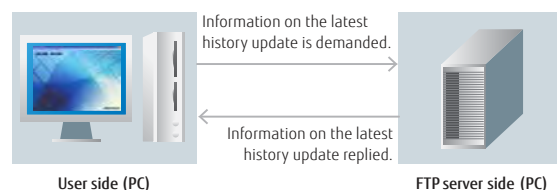

### Update your Design Simulator

Database can be easily updated online using AutoUpdate function through FTP.



**NEW** **BIM** Building Information Modeling



**BIM files of Fujitsu General's products available on BIMobject®**

We are pleased to inform that Fujitsu General has released BIM files of products on BIMobject®'s website (BIMobject.com).

**Outline of BIMobject**

BIMobject® is a game changer for the construction industry, offering development, maintenance, and syndication of objects on the world's biggest BIM platform.

**About the BIM file**

- BIM files are Autodesk Revit 2018 version.
- Each of the BIM files has different refrigerant and drain piping connector location.
- Each of the BIM file includes several family types.
- Revit file type catalog (Specification) is available for every product.



Go to search bar and key in the brand name FUJITSU GENERAL to search the products



**RFA (Revit data)**

Data format available for BIM-designed projects.

**Data content**

- Shape (Size)
- Drain direction
- Piping direction
- Power source location
- Specifications etc.



**Type catalog (specifications of product)**



**DWG**

Standard data available for Autodesk's products.



**DXF**

Intermediate data generally available for CAD products.

**Data content**

- Shape (Size)



\*How to use the BIM files please refer to Instruction video on each product page.

[youtu.be/wfL-hwFQ7dM](https://youtu.be/wfL-hwFQ7dM)

# 2020 New Products



SPLIT

## Wall Mounted

Designer Series  
Cool Beauty Design

030

- 7/9/12/14 class 4 models, 2 colors
- New compact design chassis
- High energy efficiency
- New type Wireless LAN adaptor (option)
- R32 refrigerant & low refrigerant volume



KE  
Series



## Wall Mounted

Standard Series  
High Efficiency & Large Room

034

- 18/24 class 2 models
- High energy efficiency
- Compact and lightweight outdoor unit
- New type Wireless LAN adaptor (option)
- R32 refrigerant & low refrigerant volume



KM  
Series

## 3 Phase models

Cassette, Medium Static Pressure Duct,  
High Static Pressure Duct,

044, 048, 050, 052

- Newly added 3 phase models
- Meets the various needs for shops and offices



Circular Flow Cassette

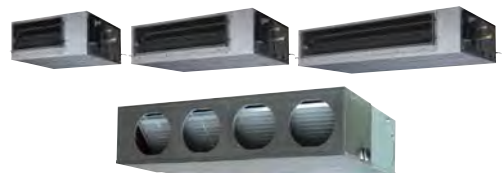

Medium Static Pressure Duct



High Static Pressure Duct

## Ceiling

Light Elegant Design  
New Design Ceiling

062

- 18/22/24/30/36/45/54 class 9 models
- Light Elegant Design
- Flexible & Easy installation design
- Easy maintenance



18/22 class



24/30 class



36/45/54 class  
(Single Phase / 3 Phase)



**MULTI-SPLIT**

## 2-unit to 5-unit Multi-split type Indoor units

076

### KM Series

- 4 models
- Capacity range from 2.0 kW to 4.0 kW class

### KE Series

- 8 models, 2 colours
- Capacity range from 2.0 kW to 4.0 kW class



KM Series



KE Series

## Simultaneous Multi-split type Twin/Triple

098

- 4/5/6 HP, Single & 3 phase, 6 models
- Slim & Compact design outdoor unit
- Flexible installation



Twin 36 class



Twin/Triple 45/54 class





VRF

### AIRSTAGE™ J-IVL

Outdoor Unit 8 - 18 HP model

152~

- Slim & compact design
- Top class low noise
- Up to 42 indoor units can be connected
- Design with small refrigerant volume
- Intelligent refrigerant control



8/10/12 HP

14/16/18 HP

### AIRSTAGE™ J-IV

Outdoor Unit 4/5/6 HP model, Single & 3 Phase

148~

- Slim & compact design
- Top class low noise
- Up to 14 indoor units can be connected (6 HP)
- Intelligent refrigerant control



### AIRSTAGE™ J-IVS

Outdoor Unit 4/5/6 HP model

144~

- Height 998 mm Compact & light weight design
- Low sound level design
- Up to 13 indoor units can be connected (5/6 HP)
- Intelligent refrigerant control



### AIRSTAGE™ VR-IV

Outdoor Unit 8 - 48 HP model

160~

- Smart and cutting-edge design.
- Top class low noise
- Up to 64 indoor units can be connected
- Simultaneous cooling and heating operation using 1 refrigerant system
- Intelligent refrigerant control



8/10/12 HP

14/16 HP

RB unit Multi-split type for Heat recovery (8-branch / 12-branch)

221

- Flexible piping connection
- Flexible installation
- Easy to maintain in a narrow space



8-branch



12-branch



## VENTILATION

### Air Handling Unit

238~

- Full comfort
- Easy design and installation
- Total solution concept



### Air Handling Unit Controller

260

- Easy to install. Control connects to AHU programmable logic controller.
- Able to install the control after building decoration.
- Mode lock function: user can lock the running mode of Air Handling Unit.



## CONTROL SYSTEM

### Compact Wired Remote Controller

190

- Although the size is compact, the screen is large
- Large letters makes it easy to see
- Operation is simple and easy-to-understand

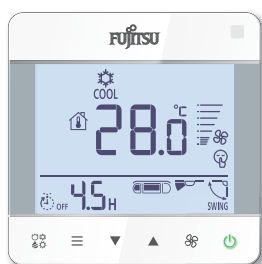

### *FGLair*<sup>™</sup> Mobile Application

105

When you add our Wireless Interface and "FGLair" app, you can control your home's cooling and heating anytime and anywhere!

- Simple design and user-friendly interface





# Light Commercial & Residential SPLIT

- 020 Indoor Units Lineup
- 023 Feature Explanation
- 024 Feature Summary



## Refrigerant type R32 models

### Wall Mounted

- 028 – High Spec & Design
  - Designer
- 032 Standard Series
  - High Efficiency & Comfort
  - High Efficiency & Large Room
- 038 Economy Series
  - Compact & Comfort
  - Comfort for Large Room

### Cassette

- 042 Economy & Standard Compact 4-way Flow Series – Compact & Comfort
- 044 Economy & Standard Circular Flow Series – Comfort for Large Room

### Duct

- 046 Economy & Standard Slim Duct – Slim & Comfort
- 048 Medium Static Pressure Duct – Compact & Comfort
- 050 Economy Medium Static Pressure Duct – Standard
- 052 High Static Pressure Duct

### Ceiling

- 062 Economy & Standard Ceiling



## Refrigerant type R410A models

### Duct

- 054 High Static Pressure Duct
- 056 Big Duct

### Floor, Floor/Ceiling

- 058 Floor – Compact & Comfort
- 060 Floor/Ceiling – Comfort & Dual Design





# Indoor Units Lineup



Type	Series	Refrigerant	Model	Capacity	
				7	9
Wall Mounted	<b>Designer Series</b> High Spec & Design				ASYG07KGTB ASYG09KGTB
	<b>Designer Series</b> Design				ASYG07KETA ASYG07KETA-B ASYG09KETA ASYG09KETA-B
	<b>Standard Series</b> High Efficiency & Comfort				ASYG07KMCC* ASYG09KMCC*
	<b>Standard Series</b> High Efficiency & Large Room				
	<b>Standard Series</b> High Efficiency & Large Room				
	<b>Economy Series</b> Compact & Comfort				ASYG09KPCA
	<b>Economy Series</b> Comfort for Large Room				
Cassette	<b>Compact 4-way Flow Series</b> Compact & Comfort				AUXG09KVLA
	<b>Circular Flow Series</b> Comfort for Large Room				
Duct	<b>Slim Duct</b>				ARXG09KLLAP
	<b>Medium Static Pressure Duct</b> Compact & Comfort				
	<b>Medium Static Pressure Duct</b> Economy				
	<b>High Static Pressure Duct</b>				
Ceiling					



Type	Series	Refrigerant	Model	Capacity		
				7	9	12
Duct	<b>High Static Pressure Duct</b>					
	<b>Big Duct</b>					
Floor	Compact & Comfort			AGYG09LVCA	AGYG12LVCA	
Floor/Ceiling	Comfort & Dual Design					



FUJITSU GENERAL (Euro) GmbH participates in the ECP programme for AIR CONDITIONERS. Check ongoing validity of certificate: [www.eurovent-certification.com](http://www.eurovent-certification.com)  
\* Models so marked are not ECC certified.

Capacity								
12	14	18	22	24	30	36	45	54
ASYG12KGTB	ASYG14KGTB							
ASYG12KETA ASYG12KETA-B	ASYG14KETA ASYG14KETA-B							
ASYG12KMTB ASYG12KMCC*	ASYG14KMTB ASYG14KMCC*							
		ASYG18KMTA		ASYG24KMTA				
					ASYG30KMTA	ASYG36KMTA		
ASYG12KPCA								
		ASYG18KLCA*		ASYG24KLCA*				
AUXG12KVLA	AUXG14KVLA	AUXG18KVLA	AUXG22KVLA	AUXG24KVLA				
		AUXG18KRLB	AUXG22KRLB	AUXG24KRLB	AUXG30KRLB	AUXG36KRLB	AUXG45KRLB	AUXG54KRLB
ARXG12KLLAP	ARXG14KLLAP	ARXG18KLLAP						
ARXG12KHTAP	ARXG14KHTAP	ARXG18KHTAP	ARXG22KHTAP	ARXG24KHTAP	ARXG30KHTAP	ARXG36KHTAP	ARXG45KHTAP	ARXG54KHTAP
			ARXG22KMLA	ARXG24KMLA	ARXG30KMLA	ARXG36KMLA	ARXG45KMLA	
							ARXG45KHTA	ARXG54KHTA
		ABYG18KRTA	ABYG22KRTA	ABYG24KRTA	ABYG30KRTA	ABYG36KRTA	ABYG45KRTA	ABYG54KRTA

Capacity									
14	18	24	30	36	45	54	60	72	90
							ARYG60LHTA		
								ARYG72LHTA*	ARYG90LHTA*
AGYG14LVCA									
	ABYG18LVTB	ABYG24LVTA							

# Control Operation from Anywhere

User friendly screen display facilitates easy operation. **NEW**

By using our Wireless LAN Interface and "FGLair" app, you can control your home's cooling and heating anytime and anywhere.

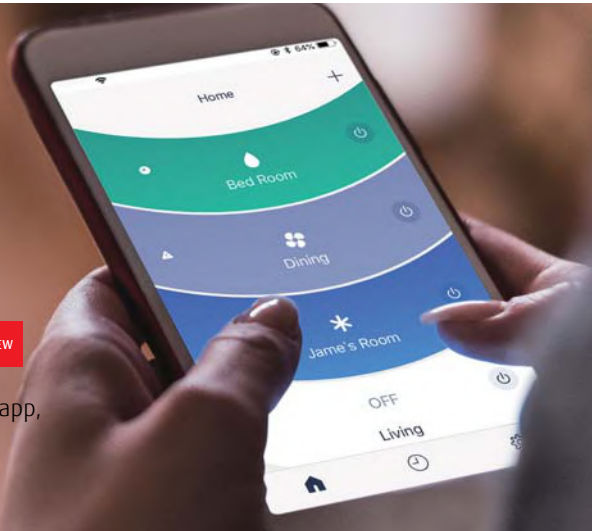

## If you forget to turn off your system before you left your home - no problem!

"FGLair" is an application software that enables you to operate the Fujitsu General's air conditioner(s) with a mobile device from either in your home or when you are on travelling.

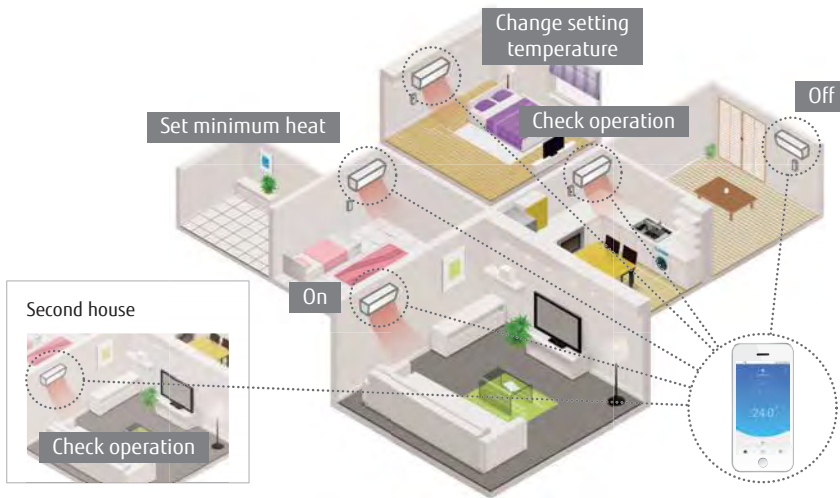

### Wireless LAN Interface

The exclusive Wireless LAN adaptor enables you to operate the air conditioner by smartphone or tablet PC from outside.

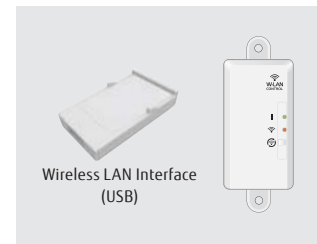

+

**FGLair**  
Download Free

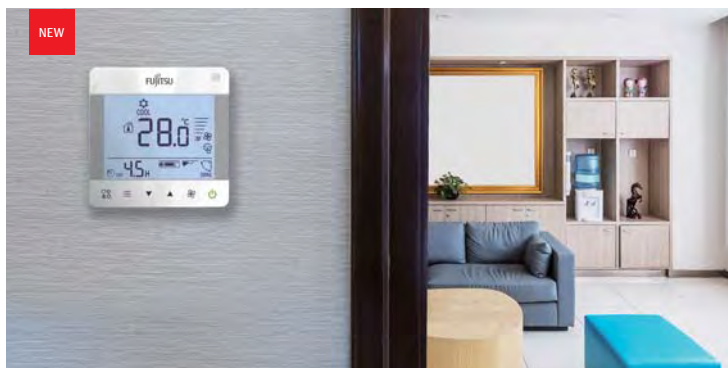

### New Compact Wired Remote Controller

Large screen and simple display

- Although the controller is compact, the screen is large
- Large letters makes it easy to see
- Operation is simple and easy-to-understand

# Feature Explanation

## Energy Saving Function

- Dual side fans**  
Comfortable space can be created with Hybrid Airflow, which creates areas of different temperatures air current and velocities.
- Economy mode**  
Thermostat setting automatically changes according to the temperature to avoid unnecessary cooling and heating.

- Save human sensor**  
Human sensor detects the movement of people in the room to operate the energy saving function operation.
- Room temperature set point limitation**  
The minimum and maximum temperature range can be set giving further energy saving while considering the comfort of the occupants.

- Save & Stop human sensor**  
Human sensor (option) detects movement of people in the room and decides whether to save energy or stop the unit.
- Set temperature auto return**  
The setting temperature automatically returns to the previously set temperature.

## Comfortable Function

- Powerful heating**  
Keeping the rated heating capacity even when the outdoor ambient temperature is -7°C.
- Powerful mode**  
Operation at maximum air flow and compressor speed, and quickly makes the room comfortable.
- Auto-changeover**  
The unit automatically switches between heating and cooling modes based on your temperature setting and the room temperature.
- Automatic fan speed**  
The micro-computer automatically adjusts the airflow effectively to follow the changes of room temperature.
- Fresh air intake**  
Fresh air can be taken in by a fan which can be connected using external control unit.

- Power diffuser**  
An additional louvre that opens based on monitoring sensors to quickly enhance immediate comfort needs.
- 10°C HEAT operation**  
The room temperature can be set to go no lower than 10°C, thus ensuring that the room does not get too cold when not occupied.
- Up/down swing flaps**  
The up/down flaps automatically swing up and down.
- Auto restart**  
In the event of a temporary power failure, the air conditioner will automatically restart in the same operating mode as before, once power supply is restored.
- Connectable distributing duct**  
Systems are capable of attaching locally purchased branch ducts distributing the airflow.

- Server room operation**  
Interlock operation is possible by connecting 2 indoor units even in low temperature.
- Low noise mode**  
Sound noise level of outdoor unit can be selected.
- Double swing automatic**  
Complex swing action of flaps enables automatically to swing both horizontal and vertical directions.
- Connectable fresh air duct**  
Outside air can be introduced by attaching locally purchased duct to fresh air knockout and optional part.
- Individual airflow direction control**  
Each louvre of 4-way Cassette type can be controlled individually and provides comfortable airflow.

## Convenient Function

- Auto off timer**  
Automatically stops operation when a fixed time has elapsed from the start of operation.
- Weekly timer**  
Different ON-OFF times can be set for each day.
- External error output**

- Sleep timer**  
The micro-computer gradually changes the room temperature automatically to afford a comfortable night's sleep.
- Weekly + setback timer**  
Weekly + Setback timer can set temperature for two times spans and for each day of the week.
- External ON/OFF input**

- Program timer**  
This digital timer allows selection of one of four options: ON, OFF, ON + OFF or OFF + ON.
- Filter sign**  
Indicates the filter cleaning period by lamp.
- Wireless LAN control**  
The exclusive Wi-Fi adaptor enables to operate the air conditioner by smartphone or tablet PC from outside.

## Clean Function

- Plasma air clean**  
The electrostatic precipitator removes dust particles such as pollens and house dust. It is washable so can be kept clean.
- Apple-catechin filter**  
The Apple-catechin filter uses static electricity to clean fine particles and dust in the air.

- Filter auto clean**  
The dust collected by the air filter is automatically removed. A routine disposal of the dust stored in the dust box is necessary.
- Long life filter**

- Ion deodorisation filter**  
The filter deodorises by powerfully decomposing absorbed odors using the oxidising and reducing effects of ions generated by the ultra-fine-particle ceramic.
- Washable panel**  
Since the front panel is easy to remove, maintenance is also easy.

## Installation

- Automatic airflow adjustment**  
Automatically detects required airflow in each application case and adjusts the volume.

- Drain pump as standard**









































- Blue fin**

**ALL DC** All DC models

**i-PAM** i-PAM control models  
i-PAM inverter control is a technology which reduces loss by adjusting the current waveform to a better sine waveform.

**V-PAM** V-PAM control models  
V-PAM inverter control reduces the effects of magnetic flux and increases the maximum speed and efficiency of the compressor by vector control technology.







# Feature Summary

Type		Wall Mounted			
Series	High Spec Series	Designer Series	Standard Series		
					
Model No.	ASYG 07/09/12/14 KGTB	ASYG 07/09/12/14 KETA, ASYG 07/09/12/14 KETA-B	ASYG 07/09/12/14 KMTA KMCC	ASYG 18/24KMTA	
					
Energy Saving Function	 Dual side fans				
	 Save human sensor	●			
	 Save & Stop human sensor				
	 Economy mode	●	●	●	●
	 Room temperature set point limitation	○		○	○
 Set temperature auto return	○		○	○	
Comfortable Function	 Powerful heating				
	 Powerful mode	●	●	●	●
	 10°C HEAT operation	●	●	●	●
	 Low noise mode	●	●	●	●
	 Auto-changeover	●	●	●	●
	 Up/down swing flaps	●	●	●	●
	 Double swing automatic				●
	 Automatic fan speed	●	●	●	●
	 Auto restart	●	●	●	●
	 Auto off timer	○		○	○
Convenient Function	 Sleep timer	●	●	●	●
	 Program timer	●	●	●	●
	 Weekly timer	●	●	○	●
	 Weekly + setback timer	○		○	○
	 Filter sign	●	●	●	●
	 External error output	○		○	○
	 External ON/OFF input	○		○	○
 Wireless LAN control	○		○	○	
Clean Function	 Plasma air clean				
	 Ion deodorisation filter	●	●	○	●
	 Apple-catechin filter	●	●	○	●
	 Long life filter				
 Washable panel	●	●		●	
Installation	 Automatic airflow adjustment				
	 Drain pump as standard				
	 Blue fin				



Wall Mounted











Economy Series

			
	ASYG 30/36KMTA	ASYG 07/09/12 KPCA	ASYG 18/24KLCA
			
	●		
	●	●	●
	○		
	○		
	●	●	●
	●		
	●	●	●
	●	●	●
	●	●	●
	●	●	●
	●	●	●
	○		
	●	●	●
	●	●	●
	●		
	○	●	●
	○		
	○		
	○	○	
	●		
	●		
		●	●
	●		

○: Optional function

# Feature Summary

Type		Cassette			Duct	
Series	Compact 4-way Flow Series	Circular Flow Series	Slim (With drain pump)	Medium Static Pressure (Compact & Comfort)	Medium Static Pressure (Economy)	
Model No.	AUXG 09/12/14/ 18/22/24 KVLA	AUXG 18/22/24/ 30/36/45/54 KRLB	ARXG 09/12/14/18 KLLAP	ARXG 12/14/18/ 22/24/30/ 36/45/54 KHTAP	ARXG 22/24/ 30/36/45 KMLA	
Energy Saving Function	Dual side fans					
	Save human sensor					
	Save & Stop human sensor		○			
	Economy mode	●	●	●	●	●
	Room temperature set point limitation	○	●	○	●	○
	Set temperature auto return	●	●	●	●	●
Comfortable Function	Powerful heating					
	Power diffuser					
	Server room operation					
	Powerful mode					
	10°C HEAT operation	●	○	○	○	○
	Low noise mode		○ (45/54)		○ (45/54)	○ (45)(36/MLA)
	Auto-changeover	●	●	●	●	●
	Up/down swing flaps	●	●	○		
	Double swing automatic					
	Automatic fan speed	●	●	●	●	●
	Auto restart	●	●	●	●	●
	Connectable fresh air duct		●		●	●
	Fresh air intake	○	○	○	○	○
	Connectable distributing duct		●			●
	Individual airflow direction control		●			
	Convenient Function	Auto off timer	●	●	●	●
Sleep timer		●	○	○	○	○
Program timer		●	○	○	○	○
Weekly timer		●	●	●	●	●
Weekly + setback timer		○		●	●	●
Filter sign		●	●	●	●	●
External error output			○		○	
External ON/OFF input		●	●	●	●	●
Wireless LAN control		○	○	○	○	○
Clean Function	Plasma air clean					
	Filter auto clean					
	Ion deodorisation filter					
	Apple-catechin filter					
	Long life filter				○	○
	Washable panel					
Installation	Automatic airflow adjustment				●	
	Drain pump as standard	●	●	●	●	○
	Blue fin		● (30/36/45/54)		● (30/36/45/54)	● (45)

	Duct			Floor	Floor/ Ceiling	Ceiling
	High Static Pressure		Big			
						
	ARXG 45/54KHTA	ARYG 60 LHTA	ARYG 72/90LHTA	AGYG 09/12/14 LVCA	ABYG 18LVTB, ABYG 24LVTA	ABYG 18/22/24 30/36/45/54 KRTA
						
	●	●	●	●	●	●
	○	○	●	○	○	○
	●	○	●	○	○	●
		○ (60)	○	●	●	○
	○	○	○			○
	●	●	●	●	●	●
				●	●	●
	●	●	●	●	●	●
	●	●	●	●	●	●
					●	●
	○	○	○			○
	●	○	●	○	○	●
	○	○ (60)	○	●	●	○
		○ (60)	○	●	●	○
	●	●	●	○	○	●
	●	●	●	●	●	●
			○			○
	●	○	●	○	○	●
	○	○	○	○	○	○
				●		
				●		
		○ (60)	○	●		
			●			
			○			○
	●	●	●			

○: Optional function

# Wall Mounted High Spec Series

High Spec & Design



## High energy saving

Top class high efficiency is achieved by a highly efficient lamda heat exchanger, large cross flow fan and new refrigerant.

Rank **A+++** <sup>\*1</sup>

SEER **8.5** <sup>\*1</sup> SCOP **5.1** <sup>\*1</sup>

\*1: 07, 09, 12 models



### Hybrid-heat exchanger

The heat exchange efficiency has been significantly improved with the large hybrid heat exchanger, attaining the top-level SEER and SCOP.

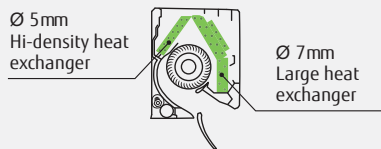

### Ø107 Large cross-flow fan

With the large-diameter fan, efficient air volume can be obtained at low power.

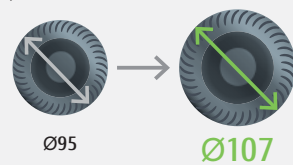

### Human sensor

Human sensor catches movements of people in a room, and operates with lower capacity when people leave the room. When people come back to the room, it automatically returns to previous operating mode.

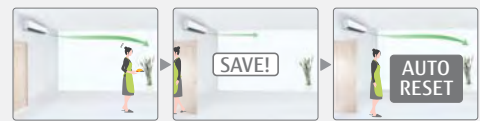

## Comfortable airflow & Silent operation

The big louvre and the new air blowing structure have attained a comfortable air flow that spreads wider to user's feet and silent operation.



**19dB(A)**  
(07/09/12 models)  
Cooling only

## Smartphone Control (Option)

Easy air conditioner control from inside or outside the house and office using Smartphones, Tablets, and PC.



### Wireless LAN Interface

The exclusive WiFi adaptor enables to operate the air conditioner by smartphone or tablet PC from outside.



Model: ASYG07KGTB / ASYG09KGTB / ASYG12KGTB / ASYG14KGTB



Wireless R.C.

## Specifications

Model No.	Indoor unit		ASYG07KGTB	ASYG09KGTB	ASYG12KGTB	ASYG14KGTB	
	Outdoor unit		AOYG07KGCA	AOYG09KGCA	AOYG12KGCA	AOYG14KGCA	
Power Source	Single-phase, ~230V, 50Hz						
Capacity	Cooling	kW	2.00	2.50	3.40	4.20	
	Heating		2.50	2.80	4.00	5.40	
UK Total/Sensible Cooling			kW	2.28/2.11	2.74/2.51	3.31/2.70	3.59/2.89
Input Power	Cooling/Heating		kW	0.400/0.500	0.555/0.560	0.805/0.910	1.175/1.350
EER	Cooling		W/W	5.00	4.50	4.22	3.57
COP	Heating			5.00	5.00	4.40	4.00
Pdesign	Cooling/Heating(-10°C)		kW	2.0/2.3	2.5/2.4	3.4/2.5	4.2/4.0
SEER	Cooling		W/W	8.52	8.52	8.51	7.11
SCOP	Heating (Average)			5.12	5.11	5.10	4.31
Energy Efficiency Class	Cooling		A+++	A+++	A+++	A++	
	Heating (Average)		A+++	A+++	A+++	A+	
Annual Energy Consumption	Cooling		kWh/a	82	103	140	207
	Heating			628	658	685	1298
Moisture Removal			l/h	1.0	1.3	1.8	2.1
Sound Pressure Level	Indoor (Cooling)	H/M/L/Q	dB(A)	38/33/29/19	40/34/29/19	40/35/30/19	43/36/30/20
	Indoor (Heating)	H/M/L/Q		41/35/31/21	42/36/31/21	42/38/33/21	44/39/33/24
Sound Power Level	Outdoor(Cooling/Heating)	High		46/46	46/48	50/50	50/50
	Indoor(Cooling/Heating)	High		54/56	55/57	56/58	57/59
	Outdoor(Cooling/Heating)	High		61/62	61/63	65/66	65/66
		High					
Airflow Rate	Indoor / Outdoor	High	m <sup>3</sup> /h	650/1610	700/1610	700/1680	770/1680
Net Dimensions H x W x D Weight	Indoor		mm	270×834×215			
			kg	10			
	Outdoor		mm	542×799×290			
			kg	30	30	31	32
Remote Controller Type (Supplied With Unit)				Wireless	Wireless	Wireless	Wireless
Interconnecting Cable (Suggested cable size 1.5mm)				3 Core + Earth			
Suggested MCB Size			Amp	10	10	10	15
Max. Operating Current	Cooling/Heating		A	6.5/9.0	6.5/9.0	6.5/9.0	9.0/10.5
Power Supply To				Outdoor			
Connection Pipe Diameter (Gas & Liquid)			Inch	3/8 & 1/4			
Max Pipe Length (Pre-Charge)			m	20 (15)			
Max Height Difference				15			
Operation Range	Cooling		°CDB	-10 to 46			
	Heating			-15 to 24			
Refrigerant	Type			R32			
	Charge		g	750	750	850	850
	Additional Charge		g/m	20	20	20	20

## Optional parts

Compact Wired Remote Controller:	UTY-RCRYZ1	Wireless LAN Interface:	UTY-TFSXW1	Network Converter for single split (DC power supply type):	UTY-VTGX
Wired Remote Controller (Touch Panel):	UTY-RNRYZ3	Communication Kit:	UTY-TWRXZ2	Network Converter for single split (AC power supply type):	UTY-VTGXV
Simple Remote Controller (Without operation mode):	UTY-RHRY	KNX® Converter:	UTY-VKSX	Wireless interface for use with Smart home products:	FJ-AC-WIFI-1
Simple Remote Controller:	UTY-RSRY	MODBUS® Converter:	UTY-VMSX		
External Switch Controller:	UTY-TERX	External input and output PCB:	UTY-XCSXZ2		
		External Connect Kit:	UTY-XWZX		

## Dimensions

(Unit : mm)

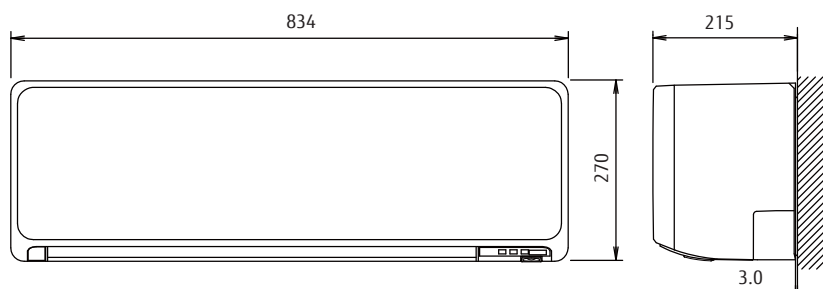

NEW

# Wall Mounted Designer Series

Cool Beauty Design



## Cool Beauty Design

We have aimed for a well-designed air conditioner especially for Europe. It is harmonised with its surroundings and it provides a comfortable elegant feeling in the room. A light elegant expression is apparent because of its beautifully curved design



**CMF : COLOUR MATERIAL FINISH**  
The texture changes the expression by the changing light of the day.

## High energy saving

Top class high efficiency is achieved by the highly efficient lamda heat exchanger, large cross flow fan and new refrigerant.

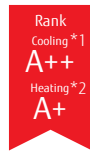

**SEER** 7.4 \*1  
**SCOP** 4.4 \*2

\*1: 07/09 models      \*2: 12 model

### Hybrid-heat exchanger

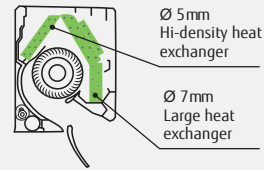

### Ø107 Large cross-flow fan



## Comfortable airflow & Silent operation

The large louvre and associated structures provide a comfortable air flow that spreads to user's feet with silent operation.



## Smartphone control (Option)

This model can be controlled from anywhere using Smart Device Control by installing an optional wireless LAN interface. The wireless LAN interface can be installed easily without specialised installation work.

When you add our Wireless Interface and FGLair app, you can control your home's cooling and heating anytime and anywhere.

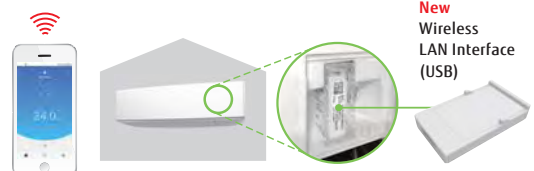

**New**  
Wireless LAN Interface (USB)



**Model: ASYG07KETA / ASYG09KETA / ASYG12KETA / ASYG14KETA (White)**  
**ASYG07KETA-B / ASYG09KETA-B / ASYG12KETA-B / ASYG14KETA-B (Grey)**



Peel white X White



Silver X Dark gray



Wireless R.C.



For ASYG07/09/12KETA  
ASYG07/09/12KETA-B



For ASYG14KETA  
ASYG14KETA-B

## Specifications

				TENTATIVE								
Model No.	Indoor unit			ASYG07KETA ASYG07KETA-B	ASYG09KETA ASYG09KETA-B	ASYG12KETA ASYG12KETA-B	ASYG14KETA ASYG14KETA-B					
	Outdoor unit			AOYG07KETA	AOYG09KETA	AOYG12KETA	AOYG14KETA					
Power Source				Single phase, ~230V, 50Hz								
Capacity	Cooling	kW	2.0 (0.9 - 3.0)				3.4 (0.9 - 3.9)	4.2 (0.9 - 4.4)				
	Heating		2.5 (0.9 - 3.4)				2.8 (0.9 - 4.0)	5.4 (0.9 - 6.0)				
UK Total/sensible cooling				2.59 / 2.44				2.65 / 2.50	3.29 / 2.71	3.65 / 2.75		
Input Power	Cooling/Heating	kW	0.450 / 0.555				0.630 / 0.620	0.935 / 0.960	1.220 / 1.410			
EER	Cooling	W/W	4.43				3.97	3.65	3.44			
COP	Heating		4.52				4.52	4.17	3.83			
Pdesign	Cooling/Heating(-10°C)	kW	2.0 / 2.3				2.5 / 2.4	3.4 / 2.5	4.2 / 4.0			
SEER	Cooling	W/W	7.40				7.40	7.30	6.9			
SCOP	Heating (Average)		4.10				4.10	4.40	4.1			
Energy Efficiency Class	Cooling	A++				A++	A++	A++				
	Heating (Average)	A+				A+	A+	A+				
Annual Energy Consumption	Cooling	kWh/a	95				118	163	213			
	Heating		785				819	795	1,367			
Moisture Removal				l/h				1.0	1.3	1.8	2.1	
Sound Pressure Level	Indoor (Cooling)	H/M/L/Q	38 / 33 / 29 / 20				40 / 34 / 29 / 20	40 / 35 / 30 / 20	43 / 36 / 30 / 20			
	Indoor (Heating)	H/M/L/Q	41 / 35 / 31 / 22				42 / 36 / 31 / 22	42 / 38 / 33 / 22	44 / 39 / 33 / 24			
Sound Power Level	Outdoor(Cooling/Heating)	High	46 / 46				46 / 46	50 / 50	50 / 50			
	Indoor(Cooling/Heating)	High	54 / 56				55 / 57	55 / 58	57 / 59			
Airflow Rate	Indoor / Outdoor (Cooling)	High	650 / 1,650				700 / 1,650	700 / 1,700	770 / 1,680			
	Indoor / Outdoor (Heating)	High	720 / 1,450				750 / 1,450	770 / 1,470	800 / 1,580			
Net Dimensions H x W x D	Indoor	mm	295×950 (wall side : 840)×230									
	Outdoor	mm	541×663×290				541×663×290	541×663×290	542×799×290			
Weight	Indoor	kg(lbs)	11(24)				11(24)	11(24)	11.5(25)			
	Outdoor	kg(lbs)	23(51)				23(51)	25(55)	31(68)			
Remote Controller Type (Supplied With Unit)				Wireless								
Interconnecting Cable (Suggested cable size 1.5mm)				3 Core + Earth								
Suggested MCB Size				Amp				15	15	15	15	
Max. Operating Current				Cooling/Heating				A	6.5 / 9.0	6.5 / 9.0	6.5 / 9.0	6.5 / 9.0
Power Supply To				Outdoor								
Connection Pipe Diameter (Gas / Liquid)				Inch				3/8 & 1/4	3/8 & 1/4	3/8 & 1/4	3/8 & 1/4	
Max Pipe Length (Pre-Charge)				m				20 (15)	20 (15)	20 (15)	20 (15)	
Max Height Difference				m				15	15	15	15	
Refrigerant	Type	R32 (675)		R32 (675)		R32 (675)		R32 (675)				
	Charge	g/m	600				600	700	850			
	Additional Charge	g	20				20	20				
Operation Range	Cooling	°CDB	-10 to 46				-10 to 46	-10 to 46	-10 to 46			
	Heating		-15 to 24				-15 to 24	-15 to 24	-15 to 24			

## Optional parts

Compact Wired Remote Controller:

UTY-RCRYZ1

Communication Kit:

UTY-TWRXZ2

Network Converter for single split (DC power supply type): UTY-VTGX

Wired Remote Controller (Touch Panel):

UTY-RNRYZ3

External input and output PCB:

UTY-XCSXZ2

Network Converter for single split (AC power supply type): UTY-VTGXV

Simple Remote Controller (Without operation mode):

UTY-RHRY

External Connect Kit:

UTY-XWZXZ5

KNX® Converter: UTY-VKSX\*

Simple Remote Controller:

UTY-RSRY

External Switch Controller:

UTY-TERX

MODBUS® Converter: UTY-VMSX\*

Wireless LAN Interface:

UTY-TFSXF2

Wireless interface for use with Smart home products: FJ-AC-WIFI-1

\*: It can be used only when the wireless LAN interface (UTY-TFSXF2) is removed.

## Dimensions

(Unit : mm)

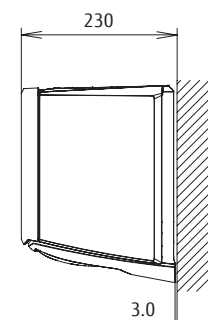
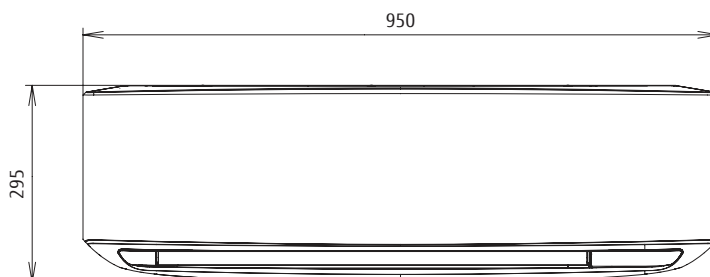

NEW

# Wall Mounted Standard Series

High Efficiency & Comfort



## Slim & stylish square design

Slim and stylish square design is realised by using a high density multi-path heat exchanger and a high efficiency fan.

### Hybrid-heat exchanger

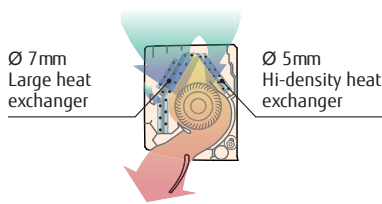

## High energy saving

Top class high efficiency is achieved by the highly efficient lamda heat exchanger, large cross flow fan and new refrigerant.

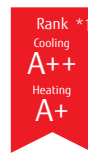

SEER 7.4 \*1

\*1: 07/09 models

SCOP 4.4 \*2

\*2: 12 model

## Comfortable airflow & Silent operation

The large louvre and associated structures provide a comfortable air flow that spreads to user's feet with silent operation.



20dB(A)  
Cooling only

## Smartphone Control (Option)

Easy air conditioner control from inside or outside the house and office using Smartphones, Tablets, and PC.



### Wireless LAN Interface

The exclusive WiFi adaptor enables to operate the air conditioner by smartphone or tablet PC from outside.





Model: ASYG07KMCC / ASYG09KMCC / ASYG12KMTB(CC) / ASYG14KMTB(CC)



For ASYG07/09/12KMCC

For ASYG14KMCC

Wireless R.C.

## Specifications

Model No.	Indoor unit		ASYG07KMCC	ASYG09KMCC	ASYG12KMTB ASYG12KMCC	ASYG14KMTB ASYG14KMCC	
	Outdoor unit		AOYG07KMCC	AOYG09KMCC	AOYG12KMTB AOYG12KMCC	AOYG14KMTB AOYG14KMCC	
Power Source	Single-phase, ~230V, 50Hz						
Capacity	Cooling	kW	2.0 (0.9-3.0)	2.5 (0.9-3.2)	3.4 (0.9-3.9)	4.2 (0.9-4.4)	
	Heating		2.5 (0.9-3.4)	2.8 (0.9-4.0)	4.0 (0.9-5.3)	5.4 (0.9-6.0)	
UK Total/Sensible Cooling			2.59/2.44	2.65/2.50	3.29/2.71	3.65/2.75	
Input Power	Cooling/Heating		0.450/0.555	0.630/0.620	0.935/0.960	1.220/1.410	
EER	Cooling	W/W	4.43	3.97	3.65	3.44	
COP	Heating		4.52	4.52	4.17	3.83	
Pdesign	Cooling/Heating(-10°C)		2.0/2.3	2.5/2.4	3.4/2.5	4.2/4.0	
SEER	Cooling	W/W	7.40	7.40	7.30	6.90	
SCOP	Heating (Average)		4.10	4.10	4.40	4.10	
Energy Efficiency Class	Cooling		A++	A++	A++	A++	
	Heating (Average)		A+	A+	A+	A+	
Annual Energy Consumption	Cooling	kWh/a	97	118	168	213	
	Heating		785	820	813	1366	
Moisture Removal			1.0	1.3	1.8	2.1	
Sound Pressure Level	Indoor (Cooling)	H/M/L/Q	dB(A)	38/33/29/20	40/34/29/20	40/35/30/20	43/36/30/20
	Indoor (Heating)	H/M/L/Q		41/35/31/22	42/36/31/22	42/38/33/22	44/39/33/24
	Outdoor(Cooling/Heating)	High		46/46	46/46	50/50	50/50
Sound Power Level	Indoor(Cooling/Heating)	High	54/56	55/57	55/58	57/59	
	Outdoor(Cooling/Heating)	High	61/61	61/62	65/65	65/66	
Airflow Rate	Indoor / Outdoor	High	650/720	700/750	700/770	770/800	
Net Dimensions H x W x D Weight	Indoor	mm	270×834×222	270×834×222	270×834×222	270×834×222	
		kg	10	10	10	10	
	Outdoor	mm	541×663×290	541×663×290	541×663×290	542×799×290	
		kg	23	23	25	31	
Remote Controller Type (Supplied With Unit)	Wireless						
Interconnecting Cable (Suggested cable size 1.5mm)	3 Core + Earth						
Suggested MCB Size	Amp		10	10	10	15	
Max. Operating Current	Cooling/Heating		6.5/9.0	6.5/9.0	6.5/9.0	6.5/9.0	
Power Supply To	Outdoor						
Connection Pipe Diameter (Gas / Liquid)	Inch		3/8 & 1/4	3/8 & 1/4	3/8 & 1/4	3/8 & 1/4	
Max Pipe Length (Pre-Charge)	m		20 (15)	20 (15)	20 (15)	20 (15)	
Max Height Difference			15	15	15	15	
Refrigerant	Type		R32	R32	R32	R32	
	Charge		600	600	700	850	
	Additional Charge		20	20	20	20	
Operation Range	Cooling	°CDB	-10 to 46	-10 to 46	-10 to 46	-10 to 46	
	Heating		-15 to 24	-15 to 24	-15 to 24	-15 to 24	

## Optional parts

Wired Remote Controller:	UTY-RVNYM	KNX® Convertor:	UTY-VKSX
Simple Remote Controller:	UTY-RSNYM	MODBUS® Convertor:	UTY-VMSX
External connect kit:	UTY-XWZX25	External Switch Controller:	UTY-TERX
Communication kit:	UTY-TWBXF2	Network Convertor for single split (DC power supply type):	UTY-VTGX
Wireless LAN Interface:	UTY-TFSXW1	Network Convertor for single split (AC power supply type):	UTY-VTGXV
		Wireless interface for use with Smart home products:	FJ-AC-WIFI-1

## Dimensions

(Unit : mm)

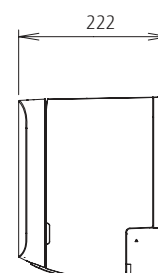
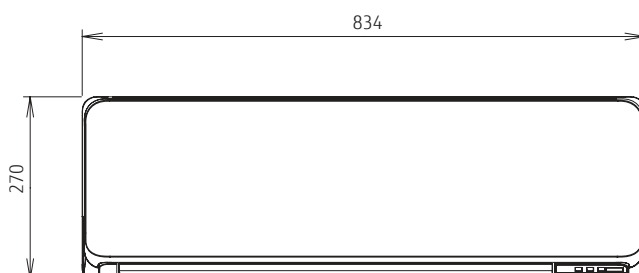

# Wall Mounted Standard Series

High Efficiency & Large Room



## High energy saving

Top class high efficiency is achieved by a highly efficient lamda heat exchanger, large cross flow fan and new refrigerant.



SEER 7.7 \*1 SCOP 4.5 \*1

\*1: 18 model

### Hybrid-heat exchanger

The heat exchange efficiency has been significantly improved with the large hybrid heat exchanger, attaining the top-level SEER and SCOP.

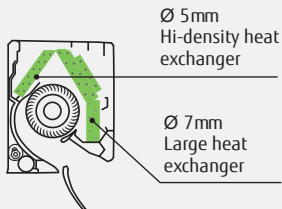

### Ø107 Large cross-flow fan

With the large-diameter fan, efficient air volume can be obtained at low power.

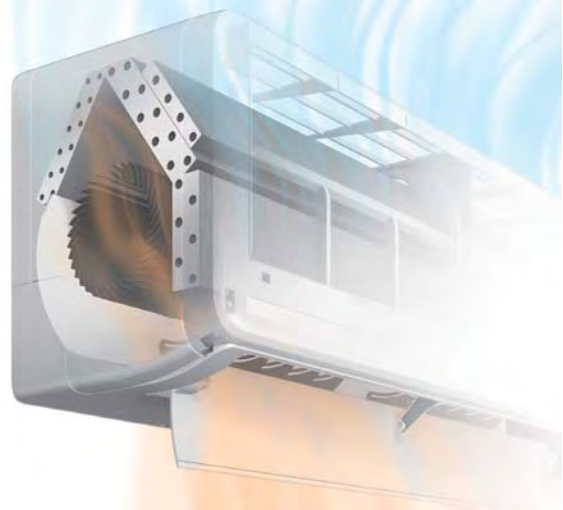

## Smartphone Control (Option)

This model can be controlled from anywhere using Smart Device Control by installing an optional wireless LAN interface. The wireless LAN interface can be installed easily without specialised installation work.

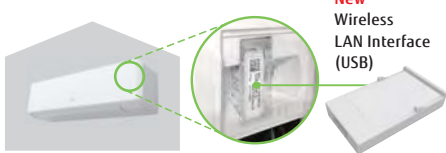

## Low ambient operation

-15°C at Heating

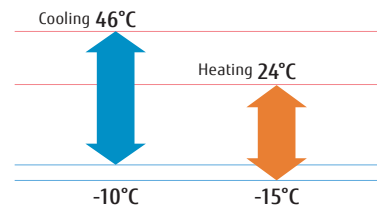

Model: ASYG18KMTA / ASYG24KMTA



Wireless R.C.

## Specifications

Model No.	Indoor unit		ASYG18KMTA		ASYG24KMTA	
	Outdoor unit		AOYG18KMTA		AOYG24KMTA	
Power Source	Single-phase, ~230V, 50Hz					
Capacity	Cooling	kW	5.2(0.9-6.0)		7.1(0.9-8.3)	
	Heating		6.3(0.9-8.7)		8.0(0.9-10.1)	
UK Total/sensible cooling		kW	4.91 / 3.76		6.7 / 4.93	
Input Power	Cooling/Heating		1.39/1.56		2.08/1.91	
EER	Cooling		3.74		3.41	
COP	Heating		4.04		4.19	
Pdesign	Cooling/Heating(-10°C)		5.2/4.8		7.1/7.1	
SEER	Cooling		7.77		7.28	
SCOP	Heating (Average)		4.56		4.18	
Energy Efficiency Class	Cooling		A++		A++	
	Heating (Average)		A+		A+	
Annual Energy Consumption	Cooling		234		341	
	Heating		1,472		2,372	
Moisture Removal			l/h		2.7	
Sound Pressure Level	Indoor (Cooling)	H/M/L/Q	45/40/35/29		49/40/35/29	
	Indoor (Heating)	H/M/L/Q	46/40/35/29		49/40/35/29	
Sound Power Level	Outdoor(Cooling/Heating)	High	50/50		54/52	
	Indoor(Cooling/Heating)	High	60/61		65/65	
Airflow Rate	Indoor / Outdoor (Cooling)	High	980/2,346		1,170/3,240	
	Indoor / Outdoor (Heating)	High	1,020/2,100		1,170/2,820	
Net Dimensions H x W x D	Indoor	mm	280 x 980 x 240		280 x 980 x 240	
	Outdoor	mm	632 x 799 x 290		716 x 820 x 315	
Weight	Indoor	kg	12.5		12.5	
	Outdoor	kg	36		42	
Remote Controller Type (Supplied With Unit)			Wireless		Wireless	
Interconnecting Cable (Suggested cable size 1.5mm)					3 Core + Earth	
Suggested MCB Size	Amp		16		16	
Max. Operating Current	Cooling/Heating		9.5/13.5		13.5/16.0	
Power Supply To					Outdoor	
Connection Pipe Diameter (Gas/Liquid)	Inch		1/2 & 1/4		1/2 & 1/4	
Max Pipe Length (Pre-Charge)	m		25(15)		30(15)	
Max Height Difference			20		25	
Operation Range	Cooling		-10 to 46		-10 to 46	
	Heating		-15 to 24		-15 to 24	
Refrigerant	Type		R32		R32	
	Charge		1020		1320	
	Additional Charge		20		20	

## Optional parts

Compact Wired Remote Controller:	UTY-RCRYZ1	Communication Kit:	UTY-TWRXZ2	Network Converter for single split (DC power supply type):	UTY-VTGX
Wired Remote Controller (Touch Panel):	UTY-RNRYZ3	External input and output PCB:	UTY-XCSXZ2	Network Converter for single split (AC power supply type):	UTY-VTGXV
Simple Remote Controller (Without operation mode):	UTY-RHRY	External Connect Kit:	UTY-XWZXZ5	KNX® Converter:	UTY-VKSX*
Simple Remote Controller:	UTY-RSRY	Wireless LAN Interface:	UTY-TFSXF2	MODBUS® Converter:	UTY-VMSX*
		External Switch Controller:	UTY-TERX	Wireless interface for use with Smart home products:	FJ-AC-WIFI-1

\*: It can be used only when the wireless LAN interface (UTY-TFSXF2) is removed.

## Dimensions

(Unit : mm)

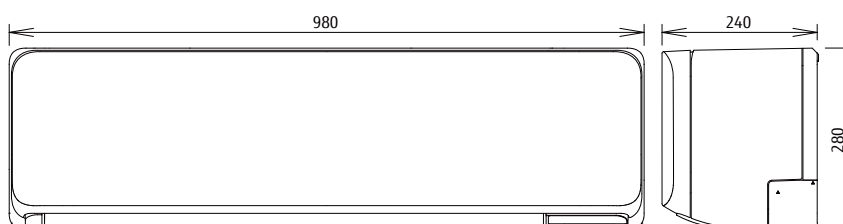

NEW

# Wall Mounted Standard Series

High Efficiency & Large Room



## Small and light weight outdoor unit

This model is much more compact than a conventional outdoor unit. It can be installed with ease in restricted spaces.



## Human sensor

Human sensor catches the movements of people in a room and operates with a lower capacity when people leave the room. When people come back to the room, it automatically returns to the previous operating mode.



## Adopting new refrigerant R32

R32 Refrigerant has a lower global warming potential than other refrigerants currently available, making it a more environmentally friendly solution.



## Smartphone control (option)

This model can be controlled from anywhere using Smart Device Control by installing an optional wireless LAN interface. The wireless LAN interface can be installed easily without specialised installation work.

When you add our Wireless Interface and FGLair app, you can control your home's cooling and heating anytime and anywhere.

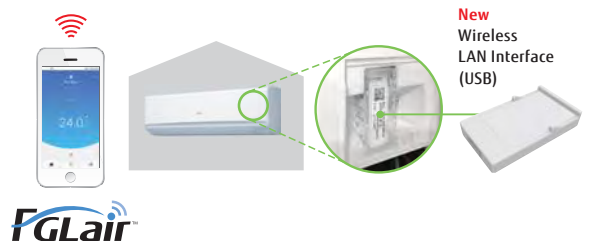



Model: ASYG30KMTA / ASYG36KMTA



Wireless R.C.

## Specifications

				TENTATIVE	
Model No.	Indoor unit		ASYG30KMTA	ASYG36KMTA	
	Outdoor unit		AOYG30KMTA	AOYG36KMTA	
Power Source			Single phase, ~230V, 50Hz		
Capacity	Cooling	kW	8.0 (2.9-9.0)	9.4(2.9-10.0)	
	Heating		8.8(2.2-11.0)	10.1(2.7-11.2)	
UK Total/sensible cooling			7.55 / 8.87	5.82 / 6.70	
Input Power	Cooling/Heating	kW	2.33/2.20	3.16/2.73	
EER	Cooling		3.43	2.97	
COP	Heating	W/W	4.00	3.70	
	Cooling/Heating(-10°C)	kW	8.0/6.5	9.4/7.1	
SEER	Cooling		6.67	6.14	
SCOP	Heating (Average)	W/W	4.54	4.52	
	Cooling		A++	A++	
Energy Efficiency Class	Heating (Average)		A+	A+	
	Cooling		419	535	
Annual Energy Consumption	Heating	kWh/a	2,001	2,198	
	Moisture Removal	l/h	2.6	3.8	
Sound Pressure Level	Indoor (Cooling)	H/M/L/Q	50/44/40/33	50/44/40/33	
	Indoor (Heating)	H/M/L/Q	49/44/39/33	49/44/39/33	
Sound Power Level	Outdoor(Cooling/Heating)	High	53/55	55/55	
	Indoor(Cooling/Heating)	High	65/65	65/65	
Airflow Rate	Outdoor(Cooling/Heating)	High	68/69	70/70	
	Indoor / Outdoor (Cooling)	High	1,330/3,750	1,330/3,750	
Net Dimensions H x W x D	Indoor / Outdoor (Heating)	High	1,330/3,750	1,330/3,750	
	Indoor	mm	340x1,150x280	340x1,150x280	
Weight	Outdoor	mm	788x940x320	788x940x320	
	Indoor	kg(lbs)	18.5(41)	18.5(41)	
Remote Controller Type (Supplied With Unit)	Outdoor	kg(lbs)	52.0(115)	52.0(115)	
	Indoor		Wireless	Wireless	
Interconnecting Cable (Suggested cable size 1.5mm)			3 Core + Earth		
Suggested MCB Size			Amp	25	25
Max. Operating Current			Cooling/Heating	A	21.0/21.0
Power Supply To			Outdoor		
Connection Pipe Diameter (Gas / Liquid)			Inch	5/8 & 3/8	5/8 & 3/8
Max Pipe Length (Pre-Charge)				50(30)	50(30)
Max Height Difference			m	30	30
Refrigerant	Type		R32	R32	
	Charge	g	1900	1900	
	Additional Charge	g/m	40	40	
Operation Range	Cooling	°CDB	-15to46	-15to46	
	Heating		-15to24	-15to24	

## Optional parts

Compact Wired Remote Controller:	UTY-RCRYZ1	External Input and Output PCB:	UTY-XCSXZ2	Network Converter for single split (DC power supply type):	UTY-VTGX
Wired Remote Controller (Touch Panel):	UTY-RNRYZ3	Communication Kit:	UTY-TWRXZ2	Network Converter for single split (AC power supply type):	UTY-VTGXV
Simple Remote Controller (Without operation mode):	UTY-RHRY	Wireless LAN Interface:	UTY-TFSXF2	Wireless interface for use with Smart home products:	FJ-AC-WIFI-1
Simple Remote Controller:	UTY-RSRY	External Switch Controller:	UTY-TERX		
External Connect Kit:	UTY-XWZXZ5	KNX® Converter:	UTY-VKSX*		
		MODBUS® Converter:	UTY-VMSX*		

\*: It can be used only when the wireless LAN interface (UTY-TFSXF2) is removed.

(Unit : mm)

## Dimensions

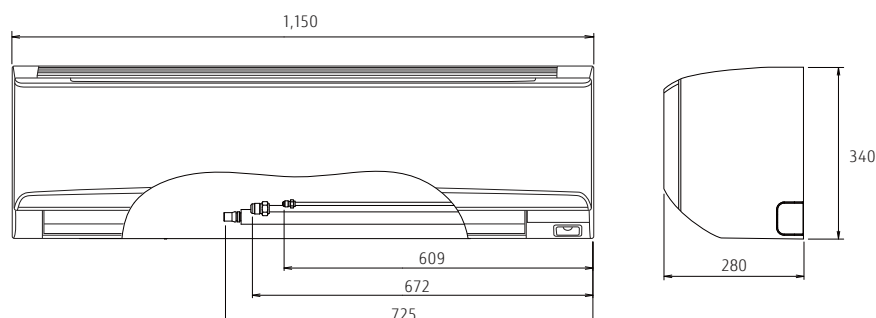

# Wall Mounted Economy Series Compact & Comfort



## Slim & stylish square design

Slim and stylish square design is achieved by a high density multi-path heat exchanger and a high efficiency fan.



## High energy saving

Top class high efficiency is achieved by a highly efficient lamda heat exchanger, large cross flow fan and new refrigerant.

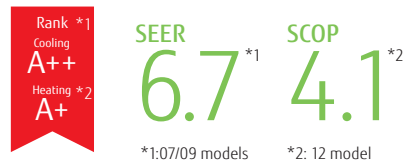

## Comfortable airflow & Silent operation

The large louvre and associated structures provide a comfortable air flow that spreads to the user's feet with silent operation.



## Smartphone Control (Option)

This model can be controlled from anywhere using Smart Device Control by installing an optional wireless LAN interface. The wireless LAN interface can be installed easily without specialised installation work.

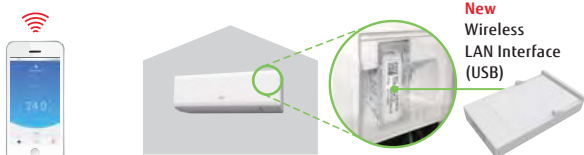

## Low ambient operation

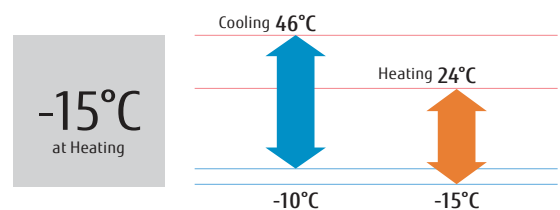

Model: ASYG09KPCA / ASYG12KPCA



Wireless R.C.

## Specifications

Model No.	Indoor unit		ASYG09KPCA		ASYG12KPCA	
	Outdoor unit		AOYG09KPCA		AOYG12KPCA	
Power Source	Single-phase, ~230V, 50Hz					
Capacity	Cooling	kW	2.5 (0.9-3.0)		3.4 (0.9-3.7)	
	Heating		2.8 (0.9-3.8)		3.8 (0.9-4.8)	
UK Total/sensible cooling	kW		2.42 / 1.59		3.09 / 2.01	
Input Power	Cooling/Heating		kW		0.71/0.79	
EER	Cooling		W/W		3.52	
COP	Heating		W/W		3.54	
Pdesign	Cooling/Heating(-10°C)		kW		2.5/2.4	
SEER	Cooling		W/W		6.70	
SCOP	Heating (Average)		W/W		4.00	
Energy Efficiency Class	Cooling		A++		A++	
	Heating (Average)		A+		A+	
Annual Energy Consumption	Cooling		kWh/a		131	
	Heating		kWh/a		840	
Moisture Removal	l/h		1.3		1.8	
Sound Pressure Level	Indoor (Cooling)	H/M/L/Q	45/38/31/22		46/40/33/22	
	Indoor (Heating)	H/M/L/Q	45/40/36/26		46/40/35/27	
	Outdoor(Cooling/Heating)	High	47/47		49/51	
Sound Power Level	Indoor(Cooling/Heating)	High	57/58		59/59	
	Outdoor(Cooling/Heating)	High	59/59		62/62	
Airflow Rate	Indoor / Outdoor (Cooling)	High	630/1,650		630/1,700	
	Indoor / Outdoor (Heating)	High	630/1,450		630/1,470	
Net Dimensions H x W x D	Indoor		mm		270x784x224	
	Outdoor		mm		541x663x290	
Weight	Indoor		kg(lbs)		8(18)	
	Outdoor		kg(lbs)		23 (51)	
Remote Controller Type (Supplied With Unit)			Wireless		Wireless	
Interconnecting Cable (Suggested cable size 1.5mm)			3 Core + Earth			
Suggested MCB Size	Amp		10		10	
Max. Operating Current	Cooling/Heating		A		6.5/9.0	
Power Supply To			Outdoor			
Connection Pipe Diameter (Gas / Liquid)	Inch		3/8 & 1/4		3/8 & 1/4	
Drain hose Diameter (I.D./O.D.)			13.8/15.8 to 16.7		13.8/15.8 to 16.7	
Max Pipe Length (Pre-Charge)	m		20 (15)		20 (15)	
Max Height Difference			15		15	
Operation Range	Cooling		°CDB		-10 to 46	
	Heating		°CDB		-15 to 24	
Refrigerant	Type		R32		R32	
	Charge		g		550	
	Additional Charge		g/m		20	

## Optional parts

Wireless LAN Interface: UTY-TFSXF2  
 Remote Controller Holder Kit: UTZ-RXLA  
 Wireless interface for use with Smart home products: FJ-AC-WIFI-1

## Dimensions

(Unit : mm)

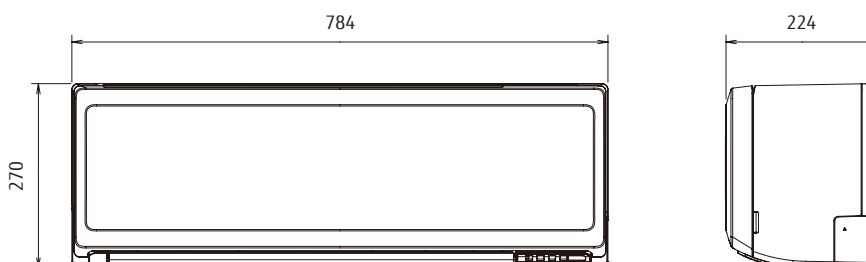

# Wall Mounted Economy Series

Comfort for Large Room



## Narrow width & Compact Design

High performance and compact design model. Powerful airflow is generated despite a 790 mm wide compact design for compact spaces such as bedrooms or home offices.



## Economy operation

Room setpoint automatically changes by 1°C to avoid unnecessary cooling and heating.

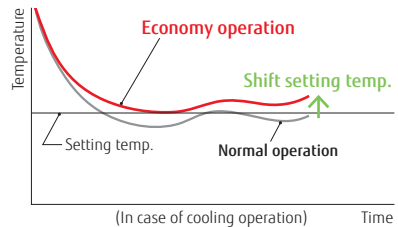

## Powerful operation

20 minutes continuous operation with maximum airflow and maximum compressor speed. Rapid cooling and heating make the room comfortable quickly.

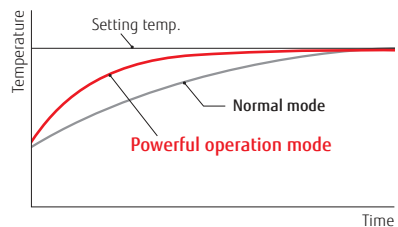

## ON-OFF Programmable timer

You can set an integrated ON-OFF or OFF-ON timer suitable for your lifestyle. (Setting time: 0.5, 1, 1.5, 2, 2.5, -----9.5, 10, 11, 12 hours)

## Low ambient operation

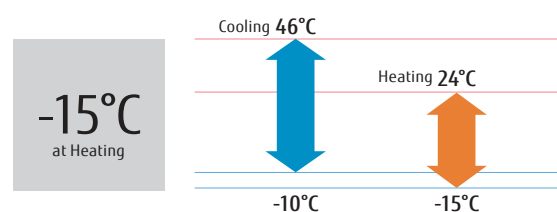



Model: ASYG18KLCA / ASYG24KLCA



For ASYG18KLCA

For ASYG24KLCA

Wireless R.C.

## Specifications

Model No.	Indoor unit		Outdoor unit		ASYG18KLCA	ASYG24KLCA
					AOYG18KLTA	AOYG24KLTA
Power Source					Single-phase, ~230V, 50Hz	
Capacity	Cooling	kW			5.2 (0.9-5.5)	7.1 (0.9-7.7)
	Heating				6.3 (0.6-7.67)	8.0 (0.9-9.0)
UK Total/sensible cooling					4.95/3.69	6.80/4.63
Input Power	Cooling/Heating		kW		1.685/1.80	2.42/2.225
EER	Cooling		W/W		3.09	2.93
COP	Heating				3.50	3.60
Pdesign	Cooling/Heating(-10°C)		kW		5.20/4.80	7.10/7.10
SEER	Cooling		W/W		7.20	7.10
SCOP	Heating (Average)				4.30	4.00
Energy Efficiency Class	Cooling				A++	A++
	Heating (Average)				A+	A+
Annual Energy Consumption	Cooling		kWh/a		253	350
	Heating				1563	2485
Moisture Removal			l/h		1.9	3.1
Sound Pressure Level	Indoor (Cooling)	H/M/L/Q			474/4/40/35	51/45/38/33
	Indoor (Heating)	H/M/L/Q			5045/41/37	52/45/41/37
Sound Power Level	Outdoor(Cooling/Heating)	High			50/56	55/57
	Indoor(Cooling/Heating)	High			60/65	64/65
Airflow Rate	Outdoor(Cooling/Heating)	High			61/66	65/67
	Indoor / Outdoor (cooling)	High	m³/h		865/1,830	1,040/2,885
Net Dimensions H x W x D	Indoor		mm		293×790×249	293×790×249
	Outdoor		mm		542×799×290	632×799×290
Weight	Indoor		kg		9.5	10.0
	Outdoor		kg(lbs)		33	38
Remote Controller Type					Wireless	
Interconnecting Cable (Suggested cable size 1.5mm)					3 Core + Earth	
Suggested MCB Size			Amp		16	20
Max. Operating Current	Cooling/Heating		A		9.5/13.5	13.5/17.5
Power Supply To					Outdoor	
Connection Pipe Diameter (Gas / Liquid)			Inch		3/8 & 1/4	1/2 & 1/4
Max Pipe Length (Pre-Charge)			m		25	30
Max Height Difference					20	25
Operation Range	Cooling		°CDB		-10 to 46	-10 to 46
	Heating				-15 to 24	-15 to 24
Refrigerant	Type				R32	R32
	Charge		g		850	1100
	Additional Charge		g/m		20	20

## Optional parts

## Dimensions

(Unit : mm)

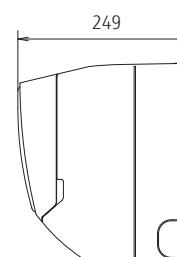
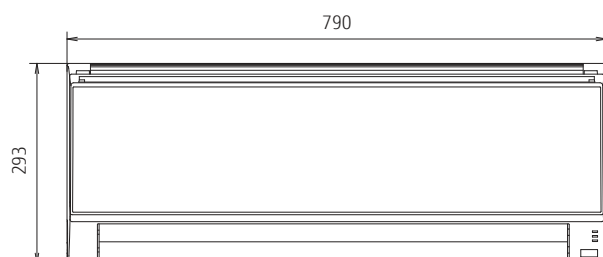

# ECONOMY & STANDARD Compact Cassette

## Compact 4-way Flow Series

Compact & Comfort



NEW

### Economy Specifications

Model No.	Indoor unit		AUXG09KVLA	AUXG12KVLA	AUXG14KVLA	AUXG18KVLA	AUXG22KVLA	AUXG24KVLA
	Outdoor unit		AOYG09KATA	AOYG12KATA	AOYG14KATA	AOYG18KATA	AOYG22KATA	AOYG24KATA
Power Source			Single phase, ~230V, 50Hz					
Capacity	Cooling	kW	2.5(0.9-2.7)	3.5(0.9-3.7)	4.3(0.9-4.5)	5.2(0.9-5.4)	6.0(0.9-6.3)	6.8(0.9-7.4)
	Heating		3.2(0.9-3.9)	4.1(0.9-4.4)	5.0(0.9-5.3)	6.0(0.9-6.3)	7.0(0.9-7.4)	7.5(0.9-8.6)
UK Total/sensible cooling			2.37 / 1.92	3.27 / 2.56	4.10 / 3.12	4.80 / 3.42	5.65 / 3.90	6.63 / 4.74
Input Power	Cooling/Heating	kW	0.68/0.88	1.09/1.17	1.37/1.42	1.69/1.72	1.95/2.00	2.26/2.08
EER	Cooling	W/W	3.68	3.21	3.14	3.08	3.08	3.01
	Heating		3.64	3.50	3.52	3.49	3.50	3.61
Pdesign	Cooling/Heating(-10°C)	kW	2.5/2.3	3.5/2.8	4.3/3.2	5.2/3.8	6.0/4.4	6.8/5.4
SEER	Cooling	W/W	6.2	6.1	6.1	6.1	6.1	5.9
	Heating		4.0	4.0	4.0	3.9	3.9	3.8
SCOP	Cooling	W/W	4.0	4.0	4.0	3.9	3.9	3.8
	Heating		4.0	4.0	4.0	3.9	3.9	3.8
Energy Efficiency Class	Cooling		A++	A++	A++	A++	A++	A+
	Heating		A+	A+	A+	A	A	A
Annual Energy Consumption	Cooling	kWh/a	141	201	247	298	344	403
	Heating		804	979	1,120	1,362	1,578	1,988
Moisture Removal		l/h	0.6	1.2	1.5	2.2	2.6	2.7
Sound Pressure Level	Indoor (Cooling)	H/M/L/Q	33/31/29/27	37/34/30/27	38/34/30/27	38/34/30/26	44/42/36/30	49/44/36/30
	Indoor (Heating)	H/M/L/Q	34/32/29/27	37/34/31/29	43/38/34/30	43/38/34/30	45/43/40/33	49/45/40/33
Sound Power Level	Outdoor(Cooling/Heating)	High	47/48	49/50	50/51	51/52	52/53	54/55
	Indoor(Cooling/Heating)	High	46/47	49/49	50/55	50/55	56/57	59/61
Airflow Rate	Outdoor(Cooling/Heating)	High	60/60	62/62	63/63	63/64	64/65	66/67
	Indoor / Outdoor (Cooling)	High	540/1,610	600/1,630	680/1,670	680/1,710	830/2,240	930/2,885
Net Dimensions H x W x D	Indoor	mm	245×570×570	245×570×570	245×570×570	245×570×570	245×570×570	245×570×570
	Outdoor	mm	541×663×290	541×663×290	542×799×290	542×799×290	632×799×290	632×799×290
Weight	Indoor	kg(lbs)	15(33)	15(33)	15(33)	15(33)	16(35)	16(35)
	Outdoor	kg(lbs)	23(51)	25(55)	32(71)	33(73)	36(79)	38(84)
Remote Controller Type (NOT Supplied With Unit)			NO CONTROLLER SUPPLIED WITH THESE UNITS PLEASE ORDER SEPARATELY					
Interconnecting Cable (Suggested cable size 1.5mm)			3 Core + Earth					
Suggested MCB Size		Amp	10	10	13	13	16	20
Max. Operating Current	Cooling/Heating	A	6.9/6.9	7.7/7.7	9.2/9.2	10.1/10.1	11.6/11.6	12.6/12.6
Power Supply To			Outdoor					
Connection Pipe Diameter (Gas / Liquid)		Inch	3/8 & 1/4	3/8 & 1/4	3/8 & 1/4	1/2 & 1/4	1/2 & 1/4	1/2 & 1/4
Max Pipe Length (Pre-Charge)		m	15 (15)	15 (15)	20 (15)	20 (15)	25 (15)	25(20)
Max Height Difference			15	15	15	15	20	20
Operation Range	Cooling	°CDB	-10 to 46	-10 to 46	-10 to 46	-10 to 46	-10 to 46	-10 to 46
	Heating		-15 to 24	-15 to 24	-15 to 24	-15 to 24	-15 to 24	-15 to 24
Refrigerant	Type		R32(675)	R32(675)	R32(675)	R32(675)	R32(675)	R32(675)
	Charge	g	600	700	850	900	1100	1250
	Additional Charge	g/m	-	-	20	20	20	20
Cassette Grille	Model name		UTG-UFYF-W	UTG-UFYF-W	UTG-UFYF-W	UTG-UFYF-W	UTG-UFYF-W	UTG-UFYF-W
	Dimensions (H × W × D)	mm	49×620×620	49×620×620	49×620×620	49×620×620	49×620×620	49×620×620
	Weight	kg(lbs)	2.3 (5)	2.3 (5)	2.3 (5)	2.3 (5)	2.3 (5)	2.3 (5)

### Easy maintenance

Maintenance is easy by removing the ceiling panel next to the grille, maintenance can be done, without the installation of a new inspection hole, so construction costs can be reduced.

The air inlet grille can be installed in various directions, so maintenance is easy.

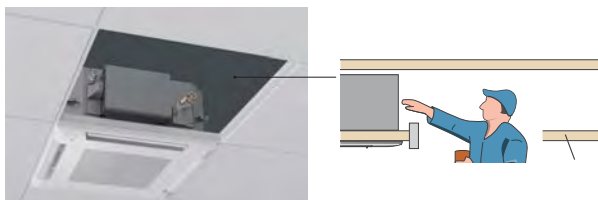

**Model: AUXG09KVLA / AUXG12KVLA / AUXG14KVLA / AUXG18KVLA / AUXG22KVLA / AUXG24KVLA**



For AUXG9/12/14KVLA



For AUXG18/22KVLA



For AUXG24KVLA

**Standard Specifications**

Model No.	Indoor unit		AUXG09KVLA	AUXG12KVLA	AUXG14KVLA	AUXG18KVLA	AUXG22KVLA	AUXG24KVLA	
	Outdoor unit		AOYG09KBTB	AOYG12KBTB	AOYG14KBTB	AOYG18KBTB	AOYG22KBTB	AOYG24KBTB	
Power Source			Single-phase, ~230V, 50Hz						
Capacity	Cooling	kW	2.5 (0.9-3.2)	3.5 (0.9-4.4)	4.3 (0.9-5.4)	5.2 (0.9-5.9)	6.0 (0.9-6.7)	6.8 (0.9-8.0)	
	Heating		3.2 (0.9-4.7)	4.1 (0.9-5.7)	5.0 (0.9-6.5)	6.0 (0.9-7.5)	7.0 (0.9-8.0)	7.5 (0.9-9.1)	
UK Total/sensible cooling			2.37 / 1.92	3.39 / 2.6	4.12 / 3.13	5.00 / 3.56	5.85/4.03	6.63 / 4.74	
Input Power	Cooling/Heating	kW	0.55/0.79	0.93/1.08	1.28/1.32	1.60/1.66	1.82/1.87	2.21/2.03	
EER	Cooling	W/W	4.57	3.76	3.36	3.25	3.30	3.08	
COP	Heating		4.05	3.80	3.79	3.61	3.74	3.69	
Pdesign	Cooling/Heating(-10°C)	kW	2.5/2.6	3.5/3.4	4.3/3.8	5.2/4.4	6.0/4.8	6.8/6.0	
SEER	Cooling	W/W	6.70	6.60	6.50	6.60	6.60	6.10	
SCOP	Heating (Average)		4.40	4.30	4.40	4.20	4.30	4.00	
Energy Efficiency Class	Cooling	A++							
	Heating (Average)	A+							
Annual Energy Consumption	Cooling	kWh/a	131	186	231	275	318	390	
	Heating		826	1,106	1,208	1,466	1,562	2,097	
Moisture Removal			l/h						
Sound Pressure Level	Indoor (Cooling)	H/M/L/Q	33/31/29/27						
	Indoor (Heating)	H/M/L/Q	34/32/29/27						
	Outdoor(Cooling/Heating)	High	46/46						
Sound Power Level	Indoor(Cooling/Heating)	High	46/47						
	Outdoor(Cooling/Heating)	High	59/59						
Airflow Rate	Indoor / Outdoor (Cooling)	High	540/1,480						
	Indoor / Outdoor (Heating)	High	540/1,410						
Net Dimensions H x W x D	Indoor	mm	245x570x570						
	Outdoor	mm	542x799x290						
Weight	Indoor	kg(lbs)	15 (33)						
	Outdoor	kg(lbs)	32 (71)						
Remote Controller Type (NOT Supplied With Unit)			NO CONTROLLER SUPPLIED WITH THESE UNITS PLEASE ORDER SEPARATELY						
Interconnecting Cable (Suggested cable size 1.5mm)			3 Core + Earth						
Suggested MCB Size			Amp						
Max. Operating Current			Cooling/Heating						
Power Supply To			Outdoor						
Connection Pipe Diameter (Gas / Liquid)			Inch						
Max Pipe Length (Pre-Charge)			m						
Max Height Difference			m						
Refrigerant	Type	R32							
	Charge	g	850						
Additional Charge		g/m	20						
Operation Range	Cooling	°CDB	-15 to 46						
	Heating		-15 to 24						
Cassette Grille Included	Model name	UTG-UFYF-W							
	Dimensions (H x W x D)	mm	49x620x620						
	Weight	kg	2.3						

**Optional parts**

- |   |                                      |  |
|---|--------------------------------------|--|
| Compact Wired Remote Controller: UTY-RCRYZ1                 | External Switch Controller: UTY-TERX | Network Converter for single split (DC power supply type): UTY-VTGX  |
| Wired Remote Controller (Touch Panel): UTY-RNRYZ3           | Wireless LAN Interface: UTY-TFSXZ1   | Network Converter for single split (AC power supply type): UTY-VTGXV |
| Wired Remote Controller: UTY-RVNYM                          | KNX® Converter: UTY-VKSX             | Fresh Air Intake Kit: UTZ-VXAA                                       |
| Simple Remote Controller (Without operation mode): UTY-RHRY | MODBUS® Converter: UTY-VMSX          | External input and output PCB: UTY-XCSX                              |
| Simple Remote Controller: UTY-RSRY                          | External Connect Kit: UTY-XWZXZG     | External input and output PCB Box: UTZ-GXRA                          |
| Wireless Remote Controller: UTY-LNTY                        |                                      | Wireless interface for use with Smart home products: FJ-AC-WIFI-1    |

**Dimensions**

(Unit : mm)

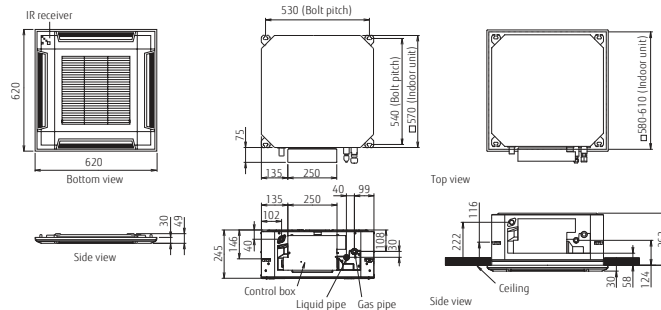

# ECONOMY & STANDARD Cassette

## Circular Flow Series

Comfort for Large Room



(30/36/45/54)

NEW

### Economy Specifications

Model No.	Indoor unit		AUXG18KRLB	AUXG22KRLB	AUXG24KRLB	AUXG30KRLB	AUXG36KRLB	AUXG45KRLB	AUXG54KRLB	AUXG36KQTA	AUXG45KQTA	AUXG54KQTA		
	Outdoor unit		AOYG18KATA	AOYG22KATA	AOYG24KATA	AOYG30KATA	AOYG36KATA	AOYG45KATA	AOYG54KATA	AOYG36KATA	AOYG45KATA	AOYG54KATA		
Power Source			Single phase, ~230V, 50Hz									3 phase, ~400V, 50Hz		
Capacity	Cooling	kW	5.2(0.9-5.4)	6.0(0.9-6.3)	6.8(0.9-7.4)	8.5(2.8-9.6)	9.5(2.8-10.6)	12.1(4.0-12.6)	13.4(4.5-13.8)	9.5(2.8-10.6)	12.1(4.0-12.6)	13.4(4.5-13.8)		
	Heating		6.0(0.9-6.3)	7.0(0.9-7.4)	7.5(0.9-8.6)	10.0(2.7-10.8)	10.8(2.7-12.5)	13.5(4.2-15.0)	15.5(4.7-16.0)	10.8(2.7-12.5)	13.5(4.2-15.0)	15.5(4.7-16.0)		
UK Total/sensible cooling			4.80/3.86	5.65/4.16	6.63/4.74	8.08/5.77	9.03/6.49	11.54/8.56	12.78/9.23	9.03/6.49	11.54/8.56	12.78/9.23		
Input Power	Cooling/Heating	kW	1.60/1.66	1.85/1.93	2.12/1.97	2.56/2.64	3.06/2.58	4.32/3.77	4.87/4.86	3.06/2.58	4.32/3.77	4.87/4.86		
	EER		W/W	3.25	3.24	3.21	3.32	3.10	2.80	2.75	3.10	2.80	2.75	
COP	Cooling	W/W		3.61	3.63	3.81	3.79	4.19	3.58	3.19	4.19	3.58	3.19	
	Heating		3.61	3.63	3.81	3.79	4.19	3.58	3.19	4.19	3.58	3.19		
Pdesign	Cooling/Heating(-10°C)	kW	5.2/3.8	6.0/4.4	6.8/5.4	8.5/8.0	9.5/8.7	-	-	9.5/8.7	-	-		
	SEER		W/W	6.2	6.2	6.1	6.1	6.1	-	-	6.1	-	-	
SCOP	Heating	W/W		4.1	4.1	4.0	4.0	4.0	-	-	4.0	-	-	
	Energy Efficiency Class		Cooling	A++	A++	A++	A++	A++	-	-	A++	-	-	
Annual Energy Consumption	Heating	kWh/a		293	338	390	488	545	-	-	545	-	-	
	Moisture Removal		l/h	1.297	1.502	1.887	2.794	3.044	-	-	3.044	-	-	
Sound Pressure Level	Indoor (Cooling)	H/M/L/Q		1.5	2.2	2.7	2.5	3.3	4.5	5.0	3.3	4.5	5.0	
	Indoor (Heating)		dB(A)	33/32/31/28	33/32/31/28	35/33/32/29	40/38/36/33	44/41/38/34	46/42/39/35	47/43/40/36	44/41/38/34	46/42/39/35	47/43/40/36	
	Outdoor (Cooling/Heating)	High		51/52	52/53	54/55	53/55	55/55	58/59	58/61	55/55	60/60	61/61	
Sound Power Level	Indoor (Cooling/Heating)	High		47/47	49/49	49/49	54/54	58/58	60/60	61/61	58/58	-/-	-/-	
Airflow Rate	Indoor / Outdoor (Cooling)	High	63/64	64/65	66/67	68/69	70/70	72/73	74/75	70/70	72/73	74/75		
	Indoor / Outdoor (Heating)		High	1,050/1,710	1,050/2,240	1,150/2,885	1,600/3,750	1,870/3,750	2,000/4,450	2,100/4,450	1,870/3,750	2,000/4,450	2,100/4,450	
Net Dimensions	Indoor	mm	1,050/1,840	1,050/2,240	1,150/2,350	1,600/3,750	1,870/3,750	2,000/4,450	2,100/4,780	1,870/3,750	2,000/4,450	2,100/4,780		
	H x W x D		Outdoor	246*840*840	246*840*840	246*840*840	288*840*840	288*840*840	288*840*840	288*840*840	288*840*840	288*840*840	288*840*840	
Weight	Indoor	kg(lbs)	542*799*290	632*799*290	632*799*290	788*940*320	788*940*320	998*940*320	998*940*320	788*940*320	998*940*320	998*940*320		
	Outdoor		23(51)	23(51)	24(53)	26(57)	29(64)	29(64)	29(64)	29(64)	29(64)	29(64)		
Remote Controller Type			Touch Panel Hard Wired Controller (Included with Grille)											
Interconnecting Cable (Suggested cable size 1.5mm)			3 Core + Earth											
Suggested MCB Size	Amp		13	16	20	25	25	32	32	16	16	16		
Max. Operating Current	Cooling/Heating	A	10.1/10.1	11.6/11.6	12.6/12.6	22.5/22.5	22.5/22.5	28.1/28.1	28.1/28.1	10.5/10.5	13.6/13.6	13.6/13.6		
Power Supply To			Outdoor											
Connection Pipe Diameter (Gas / Liquid)	Inch		1/2 & 1/4	1/2 & 1/4	1/2 & 1/4	5/8 & 3/8	5/8 & 3/8	5/8 & 3/8	5/8 & 3/8	5/8 & 3/8	5/8 & 3/8	5/8 & 3/8		
Max Pipe Length (Pre-Charge)	m		20 (15)	25 (15)	25(20)	30(30)	30(30)	30(30)	30(30)	30(30)	30(30)	30(30)		
Max Height Difference			15	20	20	30	30	30	30	30	30	30		
Operation Range	Cooling	°CDB	-10 to 46	-10 to 46	-10 to 46	-10 to 46	-10 to 46	-10 to 46	-10 to 46	-10 to 46	-10 to 46	-10 to 46		
	Heating		-15 to 24	-15 to 24	-15 to 24	-15 to 24	-15 to 24	-15 to 24	-15 to 24	-15 to 24	-15 to 24	-15 to 24		
Refrigerant	Type		R32	R32	R32	R32	R32	R32	R32	R32	R32	R32		
	Charge	g	900	1100	1250	1900	1900	2400	2400	1900	2400	2400		
	Additional Charge	g/m	20	20	20	-	-	-	-	-	-	-		
Cassette Grille			UTG-UKYA-W (Wired remote controller UTY-RNRY23 included)											
Dimensions (H x W x D)	mm		53*950*950	53*950*950	53*950*950	53*950*950	53*950*950	53*950*950	53*950*950	53*950*950	53*950*950	53*950*950		
Weight	kg(lbs)		6.0 (13)	6.0 (13)	6.0 (13)	6.0 (13)	6.0 (13)	6.0 (13)	6.0 (13)	6.0 (13)	6.0 (13)	6.0 (13)		

### Unique Circular Flow design

This cassette discharges air through 360° through a seamless louvre design.

### Individual louvre control

Each louvre can be set individually by the Touch Panel Wired Remote Controller, to enjoy the comfort of different directional airflows according to various room layouts.

\*Touch Panel Wired RC (UTY-RNRY23) only

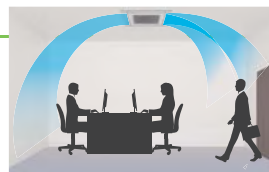

Comfortable air conditioning by preventing direct blowing of cold air and by providing swinging air flow simultaneously.



Efficient air conditioning based on the room layout

### Human sensor increases more energy saving

Energy saving operation starts automatically by detecting the motion of a person. 2 modes of 'save operation' mode and 'stop mode' can be selected.



# ECONOMY & STANDARD Slim Duct

Slim & Comfort



NEW

## Economy Specifications

Model No.	Indoor unit		ARXG09KLLAP	ARXG12KLLAP	ARXG14KLLAP	ARXG18KLLAP	
	Outdoor unit		AOYG09KATA	AOYG12KATA	AOYG14KATA	AOYG18KATA	
Power Source			Single phase, ~230V, 50Hz				
Capacity	Cooling	kW	2.5(0.9-2.7)	3.5(0.9-3.7)	4.3(0.9-4.5)	5.2(0.9-5.4)	
	Heating		3.2(0.9-3.9)	4.1(0.9-4.4)	5.0(0.9-5.3)	6.0(0.9-6.3)	
UK Total/sensible cooling			2.37 / 1.86	3.27 / 2.49	4.10 / 3.12	4.80 / 3.54	
Input Power	Cooling/Heating		kW	0.69/0.88	1.09/1.17	1.37/1.42	1.66/1.71
EER	Cooling	W/W	3.62	3.21	3.14	3.13	
	Heating		3.64	3.50	3.52	3.51	
Pdesign	Cooling/Heating(-10°C)		kW	2.5/2.3	3.5/2.8	4.3/3.2	5.2/3.8
SEER	Cooling	W/W	5.9	5.8	5.6	5.8	
SCOP	Heating		3.8	3.8	3.8	3.8	
Energy Efficiency Class	Cooling	A+		A+	A+	A+	
	Heating	A		A	A	A	
Annual Energy Consumption	Cooling	kWh/a	148	211	269	313	
	Heating		847	1,031	1,177	1,398	
Moisture Removal			l/h	0.7	1.3	1.5	2.0
Sound Pressure Level	Indoor (Cooling)	H/M/L/Q	dB(A)	28/27/26/25	29/28/26/25	32/30/28/26	32/30/29/27
	Indoor (Heating)	H/M/L/Q		28/26/25/24	29/28/26/24	32/30/28/25	32/30/29/27
Sound Power Level	Outdoor(Cooling/Heating)	High	47/48	49/50	50/51	51/52	
	Indoor(Cooling/Heating)	High	57/57	58/58	60/60	58/58	
Airflow Rate	Indoor / Outdoor (Cooling)	High	m³/h	600/1,610	650/1,630	800/1,670	940/1,710
	Indoor / Outdoor (Heating)	High		600/1,550	650/1,410	800/1,580	940/1,840
Static pressure range (Standard)			Pa	0 to 90 (25)	0 to 90 (25)	0 to 90 (25)	0 to 90 (25)
Net Dimensions H x W x D	Indoor	mm	198×700×620	198×700×620	198×700×620	198×900×620	
	Outdoor	mm	541×663×290	541×663×290	542×799×290	542×799×290	
Weight	Indoor	kg(lbs)	17(37)	17(37)	17(37)	20(44)	
	Outdoor	kg(lbs)	23(51)	25(55)	32(71)	33(73)	
Remote Controller Type (NOT Supplied With Unit)			NO CONTROLLER SUPPLIED WITH THESE UNITS PLEASE ORDER SEPARATELY				
Interconnecting Cable (Suggested cable size 1.5mm)			3 Core + Earth				
Suggested MCB Size			Amp	10	10	13	13
Max. Operating Current	Cooling/Heating		A	6.9/6.9	7.7/7.7	9.2/9.2	10.1/10.1
Power Supply To			Outdoor				
Connection Pipe Diameter (Gas / Liquid)			Inch	3/8 & 1/4	3/8 & 1/4	3/8 & 1/4	1/2 & 1/4
Max Pipe Length (Pre-Charge)			m	15 (15)	15 (15)	20 (15)	20 (15)
Max Height Difference			m	15	15	15	15
Refrigerant	Type	R32		R32	R32	R32	
	Charge	g	600	700	850	900	
	Additional Charge	g/m	-	-	20	20	
Operation Range	Cooling	°CDB	-10 to 46	-10 to 46	-10 to 46	-10 to 46	
	Heating		-15 to 24	-15 to 24	-15 to 24	-15 to 24	

### Auto Louvre Grille Kit (Option)

Simple flat Auto Louvre will provide comfort airflow and harmonise with luxury interior.

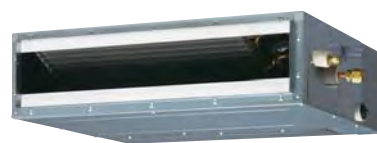

Height **198 mm**  
Drain pump built-in

### Slim design

The slim design allows installations where ceilings are narrow. Drain hose as standard accessory

**Model : ARXG09KLLAP / ARXG12KLLAP / ARXG14KLLAP / ARXG18KLLAP**



ARXG09/12/14KLLAP



ARXG18KLLAP



For ARXG09/12/14KLLAP



For ARXG18KLLAP

**Standard Specifications**

Model No.	Indoor unit		ARXG09KLLAP	ARXG12KLLAP	ARXG14KLLAP	ARXG18KLLAP
	Outdoor unit		AOYG09KBTB	AOYG12KBTB	AOYG14KBTB	AOYG18KBTB
Power Source			Single-phase, ~230V, 50Hz			
Capacity	Cooling	kW	2.5 (0.9-3.2)	3.5 (0.9-4.4)	4.3 (0.9-5.4)	5.2 (0.9-5.9)
	Heating		3.2 (0.9-4.7)	4.1 (0.9-5.7)	5.0 (0.9-6.5)	6.0 (0.9-7.5)
UK Total/sensible cooling			2.37/1.86	3.39/2.54	4.12/3.13	5.01/3.69
Input Power	Cooling/Heating	kW	0.60/0.79	0.93/1.08	1.28/1.32	1.55/1.62
EER	Cooling	W/W	4.17	3.76	3.36	3.35
COP	Heating		4.05	3.80	3.79	3.70
Pdesign	Cooling/Heating(-10°C)	kW	2.5/2.6	3.5/3.4	4.3/3.8	5.2/4.4
SEER	Cooling	W/W	6.20	6.10	5.80	6.20
SCOP	Heating		4.30	4.00	3.90	4.10
Energy Efficiency Class	Cooling	A++		A++	A+	A++
	Heating	A+		A+	A	A+
Annual Energy Consumption	Cooling	kWh/a	141	201	259	293
	Heating		845	1,189	1,362	1,501
Moisture Removal			0.7	1.3	1.5	2.0
Sound Pressure Level	Indoor (Cooling)	H/M/L/Q	28/27/26/25	29/28/26/25	32/30/28/26	32/30/29/27
	Indoor (Heating)	H/M/L/Q	28/26/25/24	29/28/26/24	32/30/28/25	32/30/29/27
Sound Power Level	Outdoor(Cooling/Heating)	High	46/46	47/47	49/49	50/50
	Indoor(Cooling/Heating)	High	57/57	58/58	60/60	58/58
Airflow Rate	Indoor / Outdoor (Cooling)	High	600/1,480	650/1,580	800/1,670	940/2,160
	Indoor / Outdoor (Heating)	High	600/1,410	650/1,520	800/1,580	940/1,830
Static pressure range (Standard)			0 to 90 (25)	0 to 90 (25)	0 to 90 (25)	0 to 90 (25)
Net Dimensions H x W x D	Indoor	mm	198x700x620	198x700x620	198x700x620	198x900x620
	Outdoor	mm	542x799x290	542x799x290	542x799x290	632x799x290
Weight	Indoor	kg(lbs)	17 (37)	17 (37)	17 (37)	20 (44)
	Outdoor	kg(lbs)	32 (71)	33 (73)	33 (73)	36 (79)
Remote Controller Type (NOT Supplied With Unit)	NO CONTROLLER SUPPLIED WITH THESE UNITS PLEASE ORDER SEPARATELY					
Interconnecting Cable (Suggested cable size 1.5mm)	3 Core + Earth					
Suggested MCB Size	Amp	10		10	16	16
Max. Operating Current	Cooling/Heating	A	7.9	9.7	10.2	12.1
Power Supply To	Outdoor					
Connection Pipe Diameter (Gas / Liquid)	Inch	3/8 & 1/4		3/8 & 1/4	3/8 & 1/4	1/2 & 1/4
Max Pipe Length (Pre-Charge)	m	20 (15)		25 (15)	25 (15)	30 (20)
Max Height Difference			15	20	20	20
Operation Range	Cooling	°CDB	-15 to 46	-15 to 46	-15 to 46	-15 to 46
	Heating		-15 to 24	-15 to 24	-15 to 24	-15 to 24
Refrigerant	Type	R32		R32	R32	R32
	Charge	g	850	850	850	1020
	Additional Charge	g/m	20	20	20	20

**Optional parts**

Compact Wired Remote Controller:	UTY-RCRYZ1	External Switch Controller:	UTY-TERX	Network Converter for single split (DC power supply type):	UTY-VTGX
Wired Remote Controller (Touch Panel):	UTY-RNRYZ3	Wireless LAN Interface:	UTY-TFSXZ1	Network Converter for single split (AC power supply type):	UTY-VTGXV
Wired Remote Controller:	UTY-RVNYM	KNX® Converter:	UTY-VKSX	Auto Louvre Grille Kit:	UTD-GXSA-W (09-14)
Simple Remote Controller (Without operation mode):	UTY-RHRY	MODBUS® Converter:	UTY-VMSX		UTD-GXSB-W (18)
Simple Remote Controller:	UTY-RSRY	Remote Sensor Unit:	UTY-XSZX	IR Receiver Unit:	UTY-LBTYM
				External Connect Kit:	UTY-XWZXXG
				Wireless interface for use with Smart home products:	FJ-AC-WIFI-1

**Dimensions**

(Unit : mm)

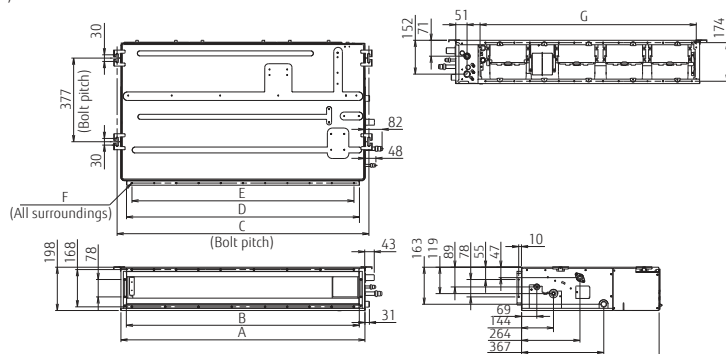

	ARXG09/12/14KLLAP	ARXG18KLLAP
A	700	900
B	650	850
C	734	934
D	650	850
E	P100x6=600	P100x8=800
F	18xØ5	22xØ5
G	574	774

# STANDARD Medium Static Pressure Duct

Compact & Comfort



(30/36/45/54)

## High Efficiency & Quiet operation

The combination of the V-shaped heat exchanger, air stabiliser, and the highly efficient DC fan motor allows high efficiency and quiet operation.

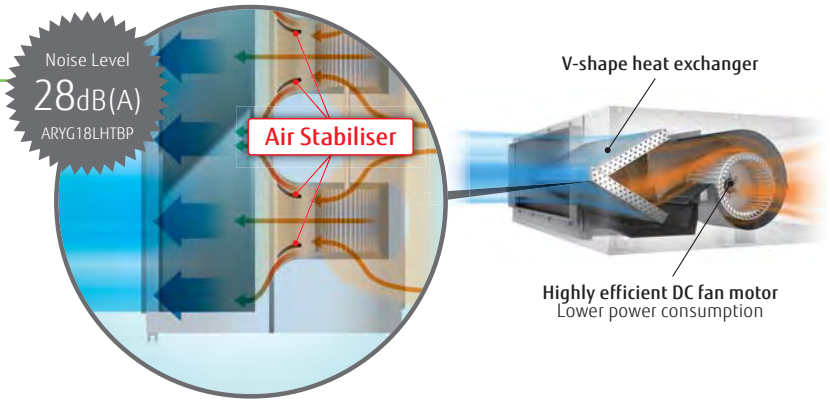

## Small and light weight outdoor unit

This model is much more compact than a conventional outdoor unit. It can be installed in a restrictive area.

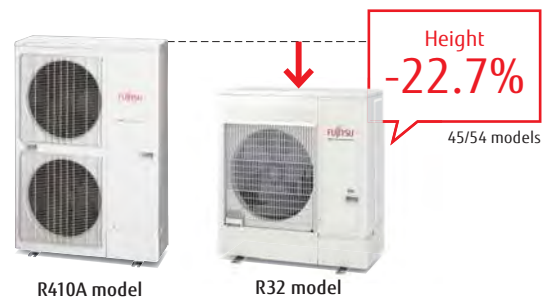

## Automatic Airflow adjustment function

This unique and innovative function detects required air flow in each application case and automatically adjust the volume.



## Low ambient operation

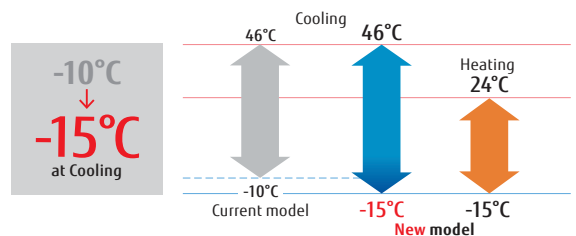





# ECONOMY Medium Static Pressure Duct



(45)

NEW

## Economy Specifications

Model No.	Indoor unit		ARXG22KMLA	ARXG24KMLA	ARXG30KMLA	ARXG36KMLA	ARXG45KMLA	ARXG36KMLA	ARXG45KMLA
	Outdoor unit		AOYG22KATA	AOYG24KATA	AOYG30KATA	AOYG36KATA	AOYG45KATA	AOYG36KQTA	AOYG45KQTA
Power Source	Single phase, ~230V, 50Hz						3 phase, ~400V, 50Hz		
Capacity	Cooling	kW	6.0(0.9-6.3)	6.8(0.9-7.4)	8.5(2.8-9.6)	9.5(2.8-10.6)	12.1(4.0-12.6)	9.5(2.8-10.6)	12.1(4.0-12.6)
	Heating		7.0(0.9-7.4)	7.5(0.9-8.6)	10.0(2.7-10.8)	10.8(2.7-12.5)	13.5(4.2-15.0)	10.8(2.7-12.5)	13.5(4.2-15.0)
UK Total/sensible cooling		kW	5.65 / 4.23	6.63 / 4.86	8.08 / 6.23	9.03 / 6.83	11.54 / 8.64	9.03 / 6.83	11.54 / 8.64
Input Power	Cooling/Heating	kW	1.92/2.00	2.19/2.00	2.78/2.77	3.13/3.03	4.84/4.18	3.13/3.03	4.84/4.18
EER	Cooling	W/W	3.13	3.11	3.06	3.04	2.50	3.04	2.50
COP	Heating		3.50	3.75	3.61	3.56	3.23	3.56	3.23
Pdesign	Cooling/Heating(-10°C)	kW	6.0/4.4	6.8/5.4	8.5/8.0	9.5/8.7	-	9.5/8.7	-
SEER	Cooling	W/W	5.8	5.9	5.8	5.6	-	5.6	-
SCOP	Heating		3.8	3.9	3.9	3.9	-	3.9	-
Energy Efficiency Class	Cooling		A+	A+	A+	A+	-	A+	-
	Heating		A	A	A	A	-	A	-
Annual Energy Consumption	Cooling	kWh/a	362	403	513	594	-	594	-
	Heating		1,620	1,935	2,871	3,122	-	3,122	-
Moisture Removal		l/h	2.1	2.5	2.5	3.0	4.0	3.0	4.0
Sound Pressure Level	Indoor (Cooling)	H/M/L/Q	31/29/27/25	31/29/27/25	39/35/30/26	39/35/30/26	42/38/32/28	39/35/30/26	42/38/32/28
	Indoor (Heating)	H/M/L/Q	31/29/27/25	31/29/27/25	42/35/30/26	42/35/30/26	42/38/32/28	42/35/30/26	42/38/32/28
	Outdoor (Cooling/Heating)	High	52/53	54/55	53/55	55/55	58/59	55/55	58/59
Sound Power Level	Indoor (Cooling/Heating)	High	60/62	60/62	65/69	65/70	68/70	65/70	68/70
	Outdoor (Cooling/Heating)	High	64/65	66/67	68/69	70/70	72/73	70/70	72/73
Airflow Rate	Indoor / Outdoor (Cooling)	High	1,100/2,240	1,100/2,885	1,900/3,750	1,900/3,750	2,100/4,450	1,900/3,750	2,100/4,450
	Indoor / Outdoor (Heating)	High	1,100/2,240	1,100/2,350	2,100/3,750	2,100/3,750	2,100/4,450	2,100/3,750	2,100/4,450
Static pressure range (Standard)		Pa	30 - 150 (35)	30 - 150 (35)	30 - 150 (47)	30 - 150 (47)	30 - 150 (60)	30 - 150 (47)	30 - 150 (60)
Net Dimensions H x W x D	Indoor	mm	270×1,135×700	270×1,135×700	270×1,135×700	270×1,135×700	270×1,135×700	270×1,135×700	270×1,135×700
	Outdoor	mm	632×799×290	632×799×290	788×940×320	788×940×320	998×940×320	788×940×320	998×940×320
Weight	Indoor	kg(lbs)	35(77)	35(77)	38(84)	38(84)	39(86)	38(84)	39(86)
	Outdoor	kg(lbs)	36(79)	38(84)	52(115)	52(115)	61(134)	53(117)	62(137)
Remote Controller Type (NOT Supplied With Unit)	NO CONTROLLER SUPPLIED WITH THESE UNITS PLEASE ORDER SEPARATELY								
Interconnecting Cable (Suggested cable size 1.5mm)	3 Core + Earth								
Suggested MCB Size	Amp		16	20	25	25	32	16	16
Max. Operating Current	Cooling/Heating	A	11.6/11.6	12.6/12.6	22.5/22.5	22.5/22.5	28.1/28.1	10.5/10.5	13.6/13.6
Power Supply To	Outdoor								
Connection Pipe Diameter (Gas / Liquid)	Inch		1/2 & 1/4	1/2 & 1/4	5/8 & 3/8	5/8 & 3/8	5/8 & 3/8	5/8 & 3/8	5/8 & 3/8
Max Pipe Length (Pre-Charge)	m		25 (15)	25(20)	30(30)	30(30)	30(30)	30(30)	30(30)
Max Height Difference			20	20	30	30	30	30	30
Refrigerant	Type		R32	R32	R32	R32	R32	R32	R32
	Charge	g	1100	1250	1900	1900	2400	1900	2400
	Additional Charge	g/m	20	20	-	-	-	-	-
Operation Range	Cooling	°CDB	-10 to 46	-10 to 46	-10 to 46	-10 to 46	-10 to 46	-10 to 46	-10 to 46
	Heating		-15 to 24	-15 to 24	-15 to 24	-15 to 24	-15 to 24	-15 to 24	-15 to 24

### Optional parts

Compact Wired Remote Controller: UTY-RCRYZ1  
 Wired Remote Controller (Touch Panel): UTY-RNRYZ3  
 Wired Remote Controller: UTY-RVNYM  
 Simple Remote Controller (Without operation mode): UTY-RHRY  
 Simple Remote Controller: UTY-RSRY  
 IR Receiver Unit: UTY-LBTYM

External Switch Controller: UTY-TERX  
 Wireless LAN Interface: UTY-TFSXZ1  
 KNX® Converter: UTY-VKSX  
 MODBUS® Converter: UTY-VMSX  
 Flange (Round): UTD-RF204  
 Flange (Square): UTD-SF045T

Network Converter for single split (DC power supply type): UTY-VTGX  
 Network Converter for single split (AC power supply type): UTY-VTGXV  
 Remote Sensor Unit: UTY-XSZX  
 External Connect Kit: UTY-XWZXZG  
 Drain Pump Unit: UTZ-PX1NBA  
 Long-Life Filter: UTD-LF25NA  
 Wireless interface for use with Smart home products: FJ-AC-WIFI-1

(Outdoor unit 30/36/45/54)  
 External Connect Kit:

UTY-XWZXZ3

Model : ARXG22KMLA / ARXG24KMLA / ARXG30KMLA / ARXG36KMLA / ARXG45KMLA  
**NEW** ARXG36KMLA [3 phase] / **NEW** ARXG45KMLA [3 phase]



## Slim & Compact design

### Indoor Unit

The slim and compact design of the indoor unit, with the control box mounted on the side, allows installation in narrow spaces.

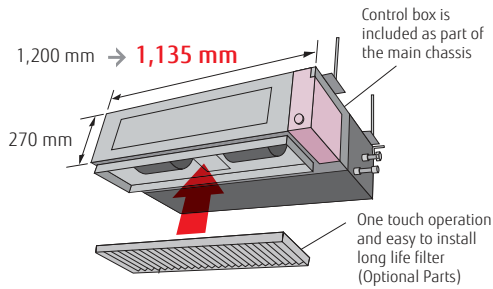

### New Outdoor Unit

The 45 model outdoor unit was changed completely. Easier installation was achieved by compact and lightweight outdoor unit.

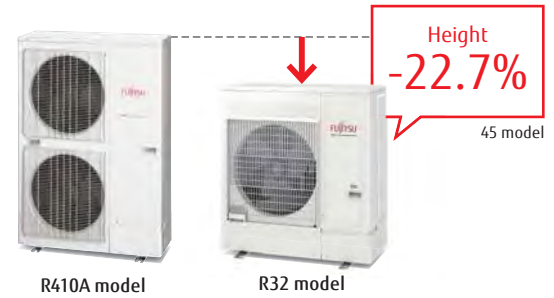

## Easy maintenance

Structural improvement is attained by making the bottom panel two pieces, front and rear. The internal fan casing is also manufactured in two pieces, namely upper and lower. The maintenance of the motor and fan can be easily carried out by removing the rear panel and the lower part of the casing while leaving the main chassis installed.

See below for the case of rear suction type

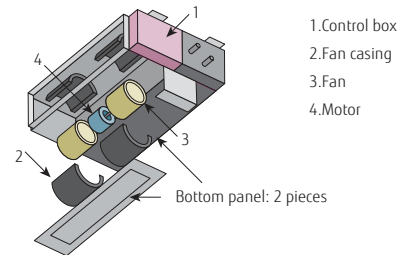

## Two-direction drain piping

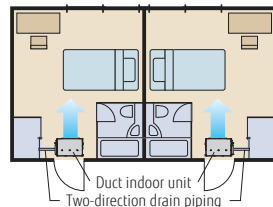

## All class low ambient operation

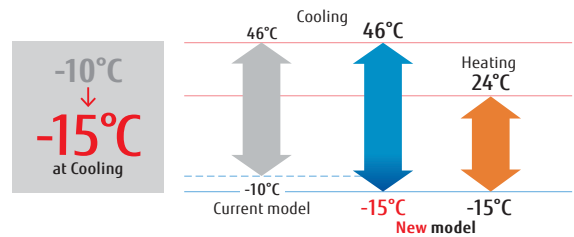

## Dimensions

(Unit : mm)

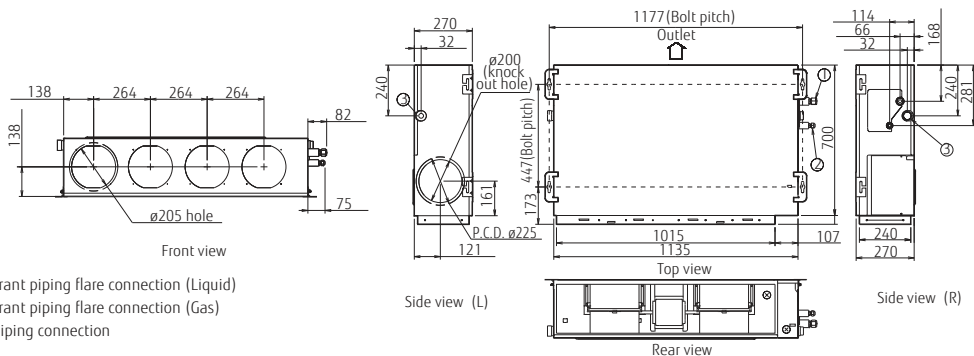

- ① Refrigerant piping flare connection (Liquid)
- ② Refrigerant piping flare connection (Gas)
- ③ Drain piping connection

# STANDARD High Static Pressure Duct



## Easy installation (Compact size & Lightweight)

A compact lightweight indoor & outdoor unit has been developed by reducing the basic chassis and the overall material weight.

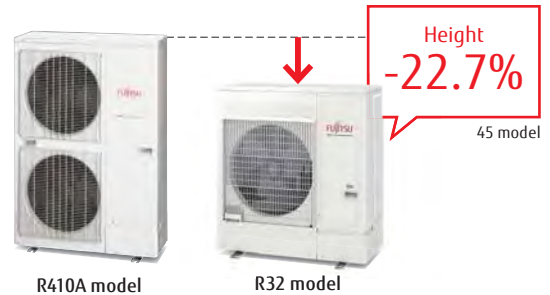
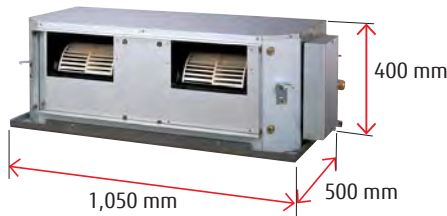

## Design also corresponding to high static pressure

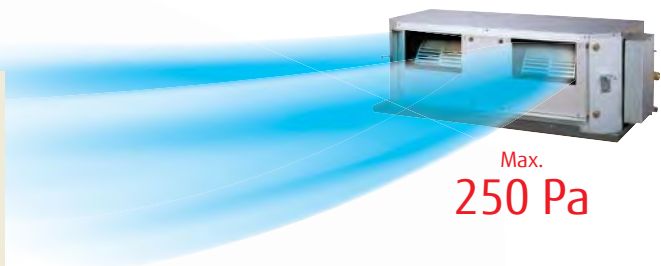
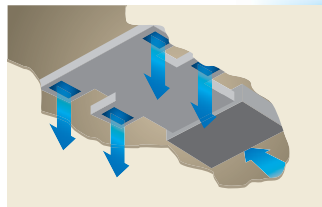

## Low noise

Cutting off the corners has enabled less turbulent airflow. Low noise is achieved by adopting a plastic case and a plastic fan.

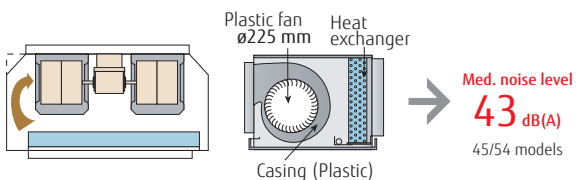

## Low ambient operation

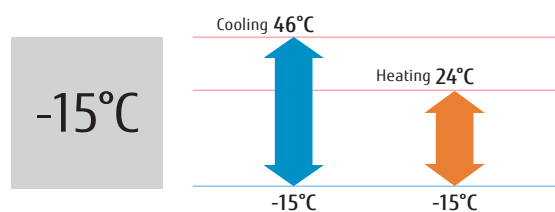

**Model : ARXG45KHTA / ARXG54KHTA**
**NEW ARXG45KHTA [3 phase] / NEW ARXG54KHTA [3 phase]**

**Standard Specifications**

Model No.	Indoor unit		ARXG45KHTA	ARXG54KHTA	ARXG45KHTA	ARXG54KHTA
	Outdoor unit		AOYG45KBTB	AOYG54KBTB	AOYG45KRTA	AOYG54KRTA
Power Source	Single-phase, ~230V, 50Hz			3 phase, ~400V, 50Hz		
Capacity	Cooling	kW	12.1 (4.0-14.0)	13.4 (5.0-14.5)	12.1 (4.0-14.0)	13.4 (5.0-14.5)
	Heating		13.5 (5.0-16.2)	15.5 (5.5-18.0)	13.5 (5.0-16.2)	15.5 (5.5-18.0)
UK Total/sensible cooling			11.54/9.68	12.78/10.60	11.54 / 9.68	12.78 / 10.60
Input Power	Cooling/Heating		4.16/3.61	4.77/4.18	4.16/3.61	4.77/4.18
EER	Cooling		2.91	2.81	2.91	2.81
COP	Heating		3.74	3.71	3.74	3.71
Pdesign	Cooling/Heating (-10°C)		-	-	-	-
SEER	Cooling		-	-	-	-
SCOP	Heating		-	-	-	-
Energy Efficiency Class	Cooling		-	-	-	-
	Heating		-	-	-	-
Annual Energy Consumption	Cooling		-	-	-	-
	Heating		-	-	-	-
Moisture Removal			1.5	2.0	1.5	2.0
Sound Pressure Level	Indoor (Cooling)	H/M/L	47/43/40	47/43/40	47/43/40	47/43/40
	Indoor (Heating)	H/M/L	47/43/40	47/43/40	47/43/40	47/43/40
	Outdoor (Cooling/Heating)	High	57/57	57/59	57/57	57/59
Sound Power Level	Indoor (Cooling/Heating)	High	75/74	75/74	75/74	75/74
	Outdoor (Cooling/Heating)	High	71/71	73/73	71/71	73/73
Airflow Rate	Indoor / Outdoor (Cooling)	High	3,350/4,450	3,350/4,450	3,350/4,450	3,350/4,450
	Indoor / Outdoor (Heating)	High	3,350/4,450	3,350/4,450	3,350/4,450	3,350/4,450
Static pressure range (Standard)			100 to 250 (100)	100 to 250 (100)	100to250 (100)	100to250 (100)
Net Dimensions H x W x D	Indoor	mm	400x1,050x500	400x1,050x500	400x1,050x500	400x1,050x500
	Outdoor	mm	998x940x320	998x940x320	998x940x320	998x940x320
Weight	Indoor	kg(lbs)	46 (101)	46 (101)	46 (101)	46 (101)
	Outdoor	kg(lbs)	67 (148)	67 (148)	67 (148)	67 (148)
Remote Controller Type (NOT Supplied With Unit)	NO CONTROLLER SUPPLIED WITH THESE UNITS PLEASE ORDER SEPARATELY					
Interconnecting Cable (Suggested cable size 1.5mm)	3 Core + Earth					
Suggested MCB Size			30	30	16	16
Max. Operating Current	Cooling/Heating		28.5	28.5	14.0/14.0	14.0/14.0
Power Supply To	Outdoor					
Connection Pipe Diameter (Gas / Liquid)			5/8 & 3/8	5/8 & 3/8	5/8 & 3/8	5/8 & 3/8
Max Pipe Length (Pre-Charge)			50 (30)	50 (30)	50 (30)	50 (30)
Max Height Difference			30	30	30	30
Operation Range	Cooling		-15 to 46	-15 to 46	-15 to 46	-15 to 46
	Heating		-15 to 24	-15 to 24	-15 to 24	-15 to 24
Refrigerant	Type		R32	R32	R32 (675)	R32 (675)
	Charge	g	2700	2700	2700	2700
	Additional Charge	g/m	40	40	40	40
Filter (To be ordered separately)			UTD-LF60KA	UTD-LF60KA	UTD-LF60KA	UTD-LF60KA

**Optional parts**

Wired Remote Controller: UTY-RVNYM  
 Simple Remote Controller: UTY-RSNYM  
 Wireless LAN Interface: UTY-TFNXZ1  
 FJ-RC-WIFI-2

External Connect Kit: UTD-ECS5A  
 Remote Sensor Unit: UTY-XSZX  
 Long-Life Filter: UTD-LF60KA  
 MODBUS® Interface: FJ-RC-MBS-1  
 KNX® Interface: FJ-RC-KNX-1i

Network Converter for single split (DC power supply type): UTY-VTGX  
 Network Converter for single split (AC power supply type): UTY-VTGVX  
 External Switch Controller: UTY-TERX  
 (Outdoor unit 45/54) UTY-XWZXZ3  
 External Connect Kit:

**Dimensions**

(Unit : mm)

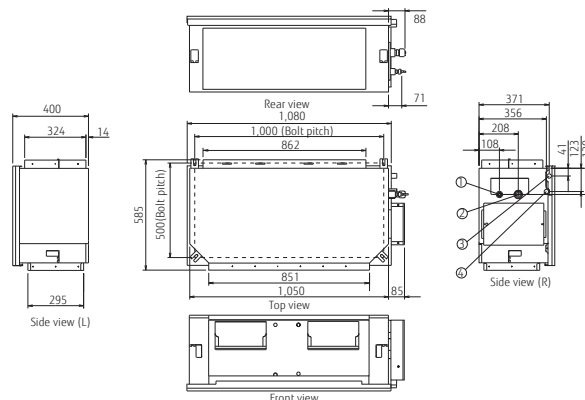

- ① Refrigerant piping flare connection (Liquid)
- ② Refrigerant piping flare connection (Gas)
- ③ Drain piping connection (Safety drain pan)
- ④ Drain piping connection (Main drain pan)

# High Static Pressure Duct



## High energy efficiency

Significantly greater efficiency is achieved by using all DC inverter technology. (60 model)

## Design also corresponding to high static pressure

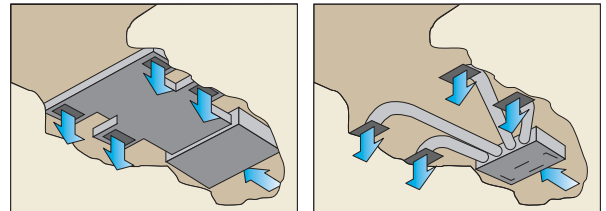
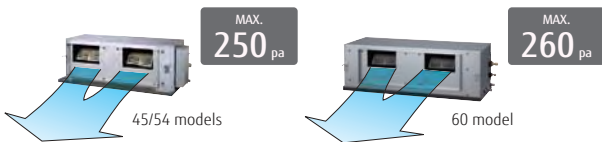

## Easy installation (Compact size & Lightweight)

A compact and lightweight indoor unit has been developed by reducing the basic chassis and the overall material weight.

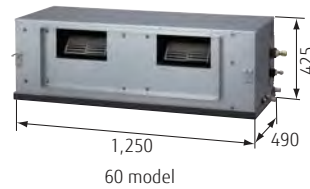

## Low noise

Cutting off the corners has enabled less turbulent airflow. Low noise is realised by adopting a plastic case and a plastic fan.

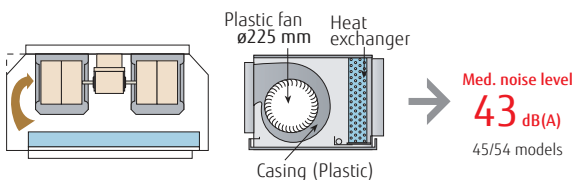

## Low ambient operation

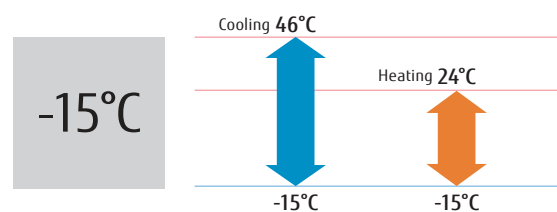

**Model : ARYG60LHTA [3 phase]**



Wired R.C.



**Standard Specifications**

Model No.	Indoor unit		Outdoor unit		ARYG60LHTA
	Outdoor unit				AOYG60LATT
Power Source					3 phase, ~400V, 50Hz
Capacity	Cooling	kW		15.0 (6.2-17.5)	
	Heating			18.0 (6.2-20.0)	
UK Total / Sensible Cooling			kW		13.47 / 12.77
Input Power	Cooling/Heating		kW		4.70/5.15
EER	Cooling		W/W		3.19
COP	Heating				3.50
Moisture Removal			l/h		2.0
Sound Pressure	Indoor (Cooling)	H/M/L/Q	dB(A)		45/40/36/-
	Indoor (Heating)	H/M/L/Q			45/40/36/-
	Outdoor(Cooling/Heating)	High			56/58
Airflow Rate	Indoor / Outdoor (Cooling)	High	m <sup>3</sup> /h		3,550/6,900
	Indoor / Outdoor (Heating)	High			3,550/7,300
Static pressure range (Standard)			Pa		60 to 260 (60)
Net Dimensions H x W x D	Indoor	mm		425×1,250×490	
	Outdoor	mm		1,290×900×330	
Weight	Indoor	kg(lbs)		54 (119)	
	Outdoor	kg(lbs)		104 (229)	
Remote Controller Type (Supplied with unit)					Wired
Interconnecting Cable (Suggested cable size 1.5mm)					3 Core +Earth
Suggested MCB Size			Amp		15
Max. Operating Current	Cooling/Heating		Amp		12.5 /12.5
Power Supply To					Outdoor
Connection Pipe Diameter (Gas / Liquid)			Inch		5/8 & 3/8
Max Pipe Length (Pre-Charge)			m		75 (30)
Max Height Difference					30
Refrigerant	Type			R410A	
	Charge	g		3,450	
	Additional Charge	g/m		50	
Operation Range	Cooling	°CDB		-15 to 46	
	Heating			-15 to 24	

**Optional parts**

Wired Remote Controller:	UTY-RVNYM	Network Converter for single split (DC power supply type):	UTY-VTGX
Simple Remote Controller:	UTY-RSNYM	Network Converter for single split (AC power supply type):	UTY-VTGXV
External Switch Controller:	UTY-TERX	External Connect Kit:	UTD-ECSSA
Wireless LAN Interface:	UTY-TFNXZ1	IR Receiver Unit	UTY-LRHVM (60)
	FJ-RC-WIFI-1		
Remote Sensor Unit:	UTY-XSZX		
MODBUS® Interface:	FJ-RC-MBS-1	External Connect Kit:	UTY-XWZXZ2
KNX® Interface:	FJ-RC-KNX-1i		

**Dimensions**

(Unit : mm)

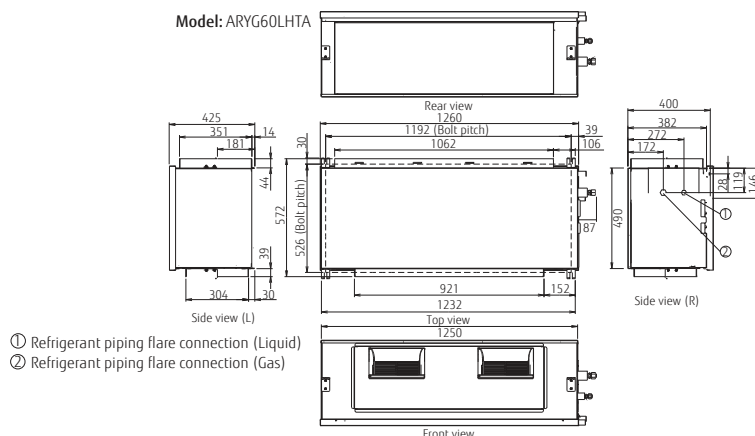

# Big Duct



## Separation is possible by lightweight compact design

The indoor unit can be separated into a fan unit and heat-exchanger unit to assist the installation.

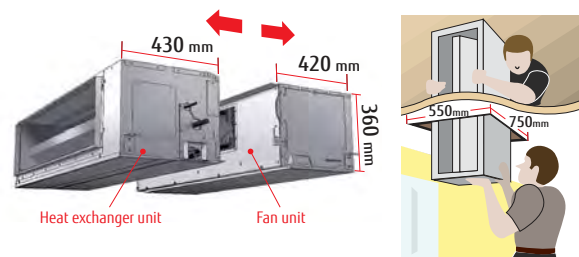

## Automatic Airflow adjustment function

This function can set the optimum airflow automatically so, that installation time is shortened drastically.



## Quiet operation

The combination of the V-shaped heat exchanger, air stabiliser, and the highly efficient DC fan motor allows quiet operation.

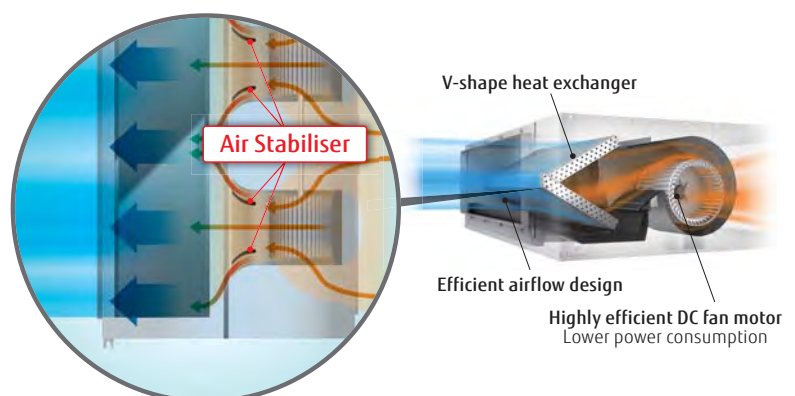



Model : ARYG72LHTA / ARYG90LHTA



Wired R.C.

### Standard Specifications

Model No.	Indoor unit		ARYG72LHTA	ARYG90LHTA
	Outdoor unit		AOYG72LRLA	AOYG90LRLA
Power Source	Indoor		Single-phase, ~230V, 50Hz	
	Outdoor		3-phase, ~400V, 50Hz	
Capacity	Cooling	kW	19.0 (8.4-20.9)	22.0 (10.3-24.2)
	Heating		22.4 (7.2-24.6)	27.0 (8.5-29.7)
UK Total / Sensible Cooling			18.96/14.65	21.95/16.62
Input Power	Cooling/Heating	kW	6.46 / 6.59	7.77 / 8.18
EER	Cooling	W/W	2.94	2.83
COP	Heating		3.4	3.3
SEER (LOT21)	Cooling	W/W	5.22	5.14
SCOP (LOT21)	Heating		3.94	3.92
Moisture Removal			4.5	6.0
Sound Pressure	Indoor (Cooling)	H/M/L/Q	46/43/41/39	47/44/42/40
	Indoor (Heating)	H/M/L/Q	46/43/41/39	47/44/42/40
	Outdoor(Cooling/Heating)	High	55/55	55/57
Airflow Rate	Indoor / Outdoor	High	m <sup>3</sup> /h	4300/8400
Static pressure range (Standard)			Pa	50 to 150 (72)
Net Dimensions H x W x D	Indoor		mm	360×1400×850
			kg(lbs)	69 (152)
	Outdoor		mm	1428×1080×480
Weight			kg(lbs)	165 (363)
Remote Controller Type (Supplied with unit)			Wired	Wired
Interconnecting Cable (Suggested cable size 2.5mm)			3 Core +Earth	
Suggested MCB Size	Amp	Outdoor 16 Amp 3ph / Indoor 6 Amp 240 1ph		Outdoor 20 Amp 3ph / Indoor 10 Amp 240 1ph
Max. Operating Current	Indoor (Cooling/Heating)	Amp	4.6/4.6	
	Outdoor (Cooling/Heating)		13.3/13.3	
Power Supply To			Outdoor + Indoor	
Connection Pipe Diameter (Gas / Liquid)	Inch		7/8 / 1/2	
Max Pipe Length (Pre-Charge)	m		100 (30)	
Height Difference			30	
Operation Range	Cooling	°CDB	-15 to 46	
	Heating		-20 to 24	
Refrigerant	Type		R410A	
	Charge	g	5,600	
	Additional Charge	g/m	110	

### Optional parts

Compact Wired Remote Controller:	UTY-RCRYZ1	External Switch Controller:	UTY-TERX	Network Converter for single split (DC power supply type):	UTY-VTGX
Wired Remote Controller (Touch Panel):	UTY-RNRYZ3	Wireless LAN Interface:	UTY-TFSXZ1	Network Converter for single split (AC power supply type):	UTY-VTGXV
Wired Remote Controller:	UTY-RVNYM		FJ-RC-WIFI-1	IR Receiver Unit:	UTY-LBTXM
Simple Remote Controller (Without operation mode):	UTY-RHRY	KNX® Converter:	UTY-VKSX		UTY-LRHYM
Simple Remote Controller:	UTY-RSRY	MODBUS® Converter:	UTY-VMSX		
	UTY-RSNYM	External input and output PCB:	UTY-XCSX	(Outdoor unit 72/90)	
External Connect Kit:	UTY-XWZXZG	Remote Sensor Unit:	UTY-XSZX	External Connect Kit:	UTY-XWZXZ3
Drain Pump Unit:	UTZ-PX1NAB	MODBUS® Interface:	FJ-RC-MBS-1		
		KNX® Interface:	FJ-RC-KNX-1i		
		Long Life Filter	UTD-LFKA		

### Dimensions

(Unit : mm)

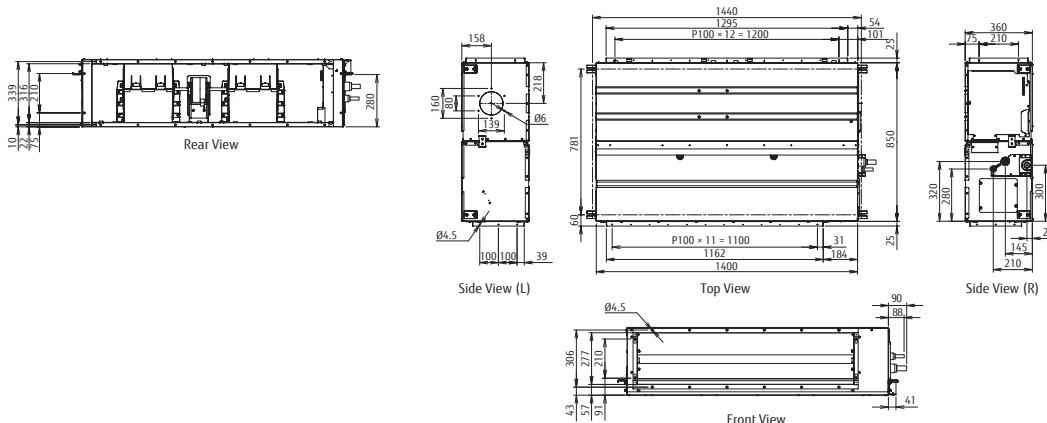

# Floor

Compact & Comfort



## Dual Fan & Wide airflow

Upper and lower air discharge allows the room to reach target temperature quickly and be maintained more comfortably.

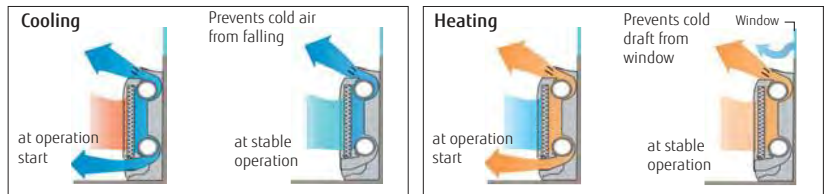

## Flexible & easy installation

The forward facing air intake makes it possible to install the unit floor mounted, wall mounted, fully concealed or partially recessed.

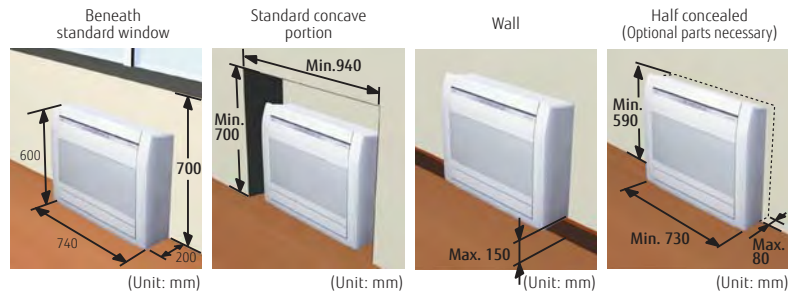

## Flexible piping connection - 6 directions of drain & piping

Drain hose and piping can be drawn flexibly from the right or left, side, and down directions.

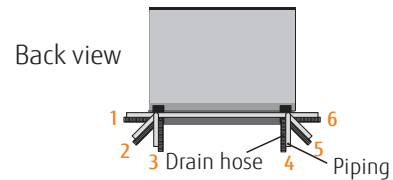

## 10°C HEAT Operation

The room temperature can be set to go no lower than 10°C, thus ensuring that the room does not get too cold when not occupied.

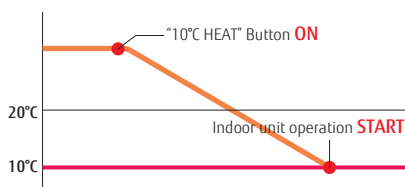

## Low ambient operation

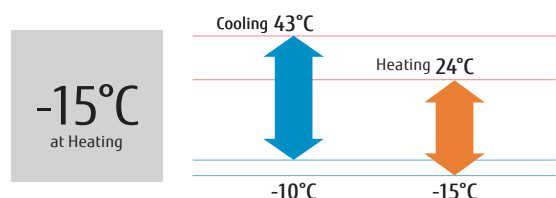

Model: AGYG09LVCA / AGYG12LVCA / AGYG14LVCA



For AGYG09/12LVCA



For AGYG14LVCA



Wireless R.C.

## Standard Specifications

Model No.	Indoor unit		AGYG09LVCA	AGYG12LVCA	AGYG14LVCA
	Outdoor unit		A0YG09LVCA	A0YG12LVCA	A0YG14LVCA
Power Source			Single phase, ~230V, 50Hz		
Capacity	Cooling	kW	2.6 (0.9-3.5)	3.5 (0.9-4.0)	4.2 (0.9-5.0)
	Heating		3.5 (0.9-5.5)	4.5 (0.9-6.6)	5.2 (0.9-8.0)
UK Total / Sensible Cooling		kW	2.49 / 2.24	3.36 / 2.59	4.03 / 2.92
Input Power	Cooling/Heating	kW	0.53/0.79	0.94/1.19	1.14/1.44
EER	Cooling	W/W	4.91	3.72	3.68
COP	Heating		4.43	3.78	3.61
Pdesign	Cooling/Heating(-10°C)	kW	2.6/2.9	3.5/3.8	4.2/4.7
SEER	Cooling (Average)	W/W	7.00	6.50	6.40
SCOP	Heating (Average)		4.20	4.00	4.00
Energy Efficiency Class	Cooling		A++	A++	A++
	Heating (Average)		A+	A+	A+
Annual Energy Consumption	Cooling	kWh/a	130	188	230
	Heating		967	1,330	1,645
Moisture Removal		l/h	1.3	1.8	2.1
Sound Pressure Level	Indoor (Cooling)	H/M/L/Q	40/35/29/22	40/35/29/22	44/38/31/22
	Indoor (Heating)	H/M/L/Q	40/35/29/22	40/35/29/22	43/37/29/22
	Outdoor(Cooling/Heating)	High	47/48	48/49	50/50
Sound Power Level	Indoor(Cooling/Heating)	High	55/56	55/56	58/58
	Outdoor(Cooling/Heating)	High	64/65	64/65	65/66
Airflow Rate	Indoor / Outdoor (Cooling)	High	570/1,680	570/1,680	650/1,910
	Indoor / Outdoor (Heating)	High	600/1,490	600/1,680	650/1,750
Net Dimensions H x W x D	Indoor	mm	600×740×200	600×740×200	600×740×200
	Outdoor	mm	540×790×290	540×790×290	578×790×300
Weight	Indoor	kg(lbs)	14 (31)	14 (31)	14 (31)
	Outdoor	kg(lbs)	36 (79)	36 (79)	40 (88)
Remote Controller Type (Supplied with unit)			Wireless	Wireless	Wireless
Interconnecting Cable (Suggested cable size 1.5mm)			3 Core + Earth		
Suggested MCB Size		Amp	10	10	16
Max. Operating Current	Cooling/Heating	A	7.0/10.0	7.0/10.0	9.0/13.5
Power Supply To			Outdoor		
Connection Pipe Diameter (Gas / Liquid)		Inch	3/8 & 1/4	3/8 & 1/4	1/2 & 1/4
Max Pipe Length (Pre-Charge)		m	20 (15)	20 (15)	20 (15)
Max Height Difference			15	15	15
Refrigerant	Type		R410A	R410A	R410A
	Charge	g	1,050	1,050	1,150
	Additional Charge	g/m	20	20	20
Operation Range	Cooling	°CDB	-10 to 43	-10 to 43	-10 to 43
	Heating		-15 to 24	-15 to 24	-15 to 24

## Optional parts

Wired Remote Controller: UTY-RVNYM  
 Simple Remote Controller: UTY-RSNYM  
 External Switch Controller: UTY-TERX  
 Wireless LAN Interface: UTY-TFNXZ1  
 FJ-RC-WIFI-1

Network Convertor for single split (DC power supply type): UTY-VTGX  
 Network Convertor for single split (AC power supply type): UTY-VTGXV  
 External Connect Kit: UTY-XWZX  
 MODBUS® Interface: FJ-RC-MBS-1  
 KNX® Interface: FJ-RC-KNX-1i

## Dimensions

(Unit : mm)

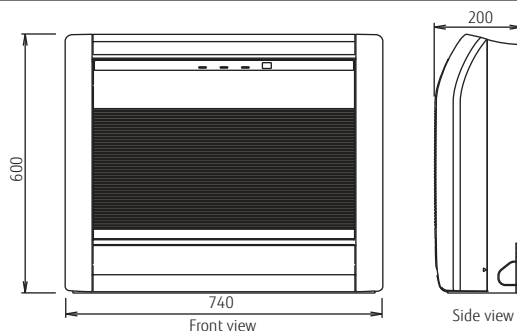

# Floor/Ceiling

Comfort & Dual Design



## Flexible installation

### Example for floor installation

Floor console



### Example for ceiling installation

Under ceiling



## Double auto swing

A combination of right/left and up/down directional swing allows 3-dimensional air direction control

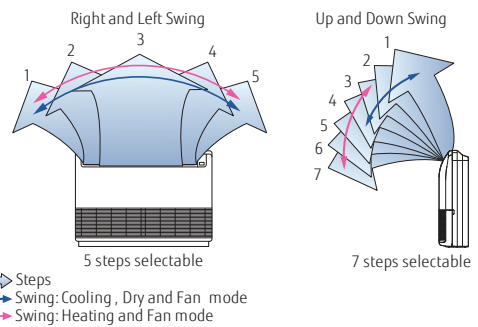

## High power DC fan motor

- High power
- Wide rotation range
- High efficiency

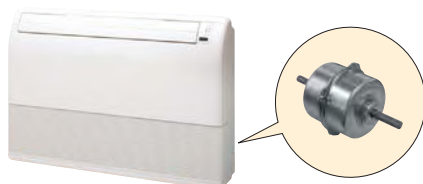

## Low ambient operation

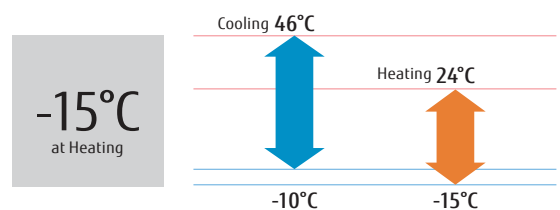

Model : ABYG18LVTB / ABYG24LVTA



For ABYG18LVTB

For ABYG24LVTA

Wireless R.C.

### Standard Specifications

Model No.	Indoor unit		ABYG18LVTB		ABYG24LVTA		
	Outdoor unit		AOYG18LBCB		AOYG24LBCB		
Power Source	Single phase, ~230V, 50Hz						
Capacity	Cooling	kW	5.2 (0.9-5.9)		6.8 (0.9-8.0)		
	Heating		6.0 (0.9-7.5)		8.0 (0.9-9.1)		
UK Total / Sensible Cooling			4.79 / 3.33		6.05 / 4.51		
Input Power	Cooling/Heating	kW	1.62/1.66		2.21/2.26		
EER	Cooling	W/W	3.21		3.08		
COP	Heating		3.61		3.54		
Pdesign	Cooling/Heating(-10°C)	kW	5.2/5.2		6.8/6.0		
SEER	Cooling	W/W	6.10		5.60		
SCOP	Heating (Average)		4.00		3.90		
Energy Efficiency Class	Cooling	A++		A+			
	Heating (Average)	A+		A			
Annual Energy Consumption	Cooling	kWh/a	298		425		
	Heating		1,818		2,153		
Moisture Removal			l/h		2.7		
Sound Pressure Level	Indoor (Cooling)	H/M/L/Q	43/40/34/31		48/44/40/35		
	Indoor (Heating)	H/M/L/Q	43/40/34/31		48/44/40/35		
Sound Power Level	Outdoor(Cooling/Heating)	High	50/50		53/54		
	Indoor(Cooling/Heating)	High	57/57		61/61		
Airflow Rate	Outdoor(Cooling/Heating)	High	62/65		66/66		
	Indoor / Outdoor (Cooling)	High	780/2,380		980/2,850		
Net Dimensions H x W x D	Indoor / Outdoor (Heating)	High	780/2,080		980/2,700		
	Indoor	mm	199×990×655		199×990×655		
Weight	Outdoor	mm	632×799×290		716×820×315		
	Indoor	kg(lbs)	27 (60)		27 (60)		
Weight	Outdoor	kg(lbs)	36 (79)		42 (93)		
	Remote Controller Type (Supplied with unit)			Wireless		Wireless	
Interconnecting Cable (Suggested cable size 2.5mm)					3 Core +Earth		
Suggested MCB Size			Amp		16		
Max. Operating Current	Cooling/Heating	A	11.5/13.5		14.7/15.7		
Power Supply To					Outdoor		
Connection Pipe Diameter (Gas / Liquid)			Inch		5/8 & 1/4		
Max Pipe Length (Pre-Charge)			m		25 (15)		
Max Height Difference					15		
					20		
Refrigerant	Type			R410A		R410A	
	Charge	g	1,250		1,700		
	Additional Charge	g/m	20		20		
Operation Range	Cooling	°CDB	-10 to 46		-10 to 46		
	Heating		-15 to 24		-15 to 24		

### Optional parts

Wired Remote Controller:	UTY-RVNYM	Network Converter for single split (DC power supply type):	UTY-VTGX
Simple Remote Controller:	UTY-RSNYM	Network Converter for single split (AC power supply type):	UTY-VTGXV
External Switch Controller:	UTY-TERX	External Connect Kit:	UTY-XWZX
Wireless LAN Interface:	UTY-TFNXZ1	MODBUS® Interface:	FJ-RC-MBS-1
	FJ-RC-WIFI-1	KNX® Interface:	FJ-RC-KNX-Ii

### Dimensions

(Unit : mm)

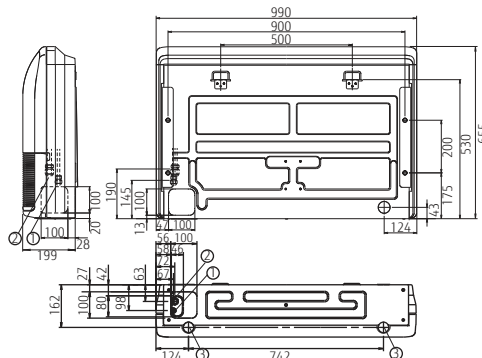

- ① Refrigerant piping flare connection (Liquid)
- ② Refrigerant piping flare connection (Gas)
- ③ Drain piping connection

NEW

# ECONOMY & STANDARD Ceiling



NEW

## Economy Specifications

Model No.	Indoor unit		TENTATIVE					TENTATIVE			
	Outdoor unit		ABYG18KRTA	ABYG22KRTA	ABYG24KRTA	ABYG30KRTA	ABYG36KRTA	ABYG45KRTA	ABYG36KQTA	ABYG45KQTA	
Power Source			Single phase, ~230V, 50Hz					3 phase, ~400V, 50Hz			
Capacity	Cooling	kW	5.2(0.9-5.4)	6.0(0.9-6.3)	6.8(0.9-7.4)	8.5(2.8-9.6)	9.5(2.8-10.6)	12.1(4.0-12.6)	9.5(2.8-10.6)	12.1(4.0-12.6)	
	Heating		6.0(0.9-6.3)	7.0(0.9-7.4)	7.5(0.9-8.6)	10.0(2.7-10.8)	10.8(2.7-12.5)	13.5(4.2-15.0)	10.8(2.7-12.5)	13.5(4.2-15.0)	
UK Total / Sensible Cooling			5.01 / 3.62	5.85 / 4.12	6.63 / 4.97	8.08 / 5.23	9.03 / 7.44	11.54 / 8.37	9.03 / 7.44	11.54 / 8.37	
Input Power	Cooling/Heating	kW	1.66/1.71	-/-	2.19/2.00	2.78/2.86	3.13/3.03	4.84/4.18	3.13/3.03	4.84/4.18	
EER	Cooling	W/W	3.13	-	3.11	3.06	3.04	2.5	3.04	2.5	
COP	Heating		3.51	-	3.75	3.5	3.56	3.23	3.56	3.23	
Pdesign	Cooling/Heating(-10°C)	kW	5.2/3.8	6.0/4.4	6.8/5.4	8.5/8.0	9.5/8.7	12.1/9.2	9.5/-	12.1/-	
SEER	Cooling	W/W	5.8	5.6	6.0	5.8	5.6	-	5.6	-	
SCOP	Heating		3.8	3.8	3.9	3.9	3.9	-	3.9	-	
Energy Efficiency Class	Cooling	A+		A+	A+	A+	A+	A+	A+		
	Heating	A		A	A	A	A	A	A		
Annual Energy Consumption	Cooling	kWh/a	-	-	-	-	-	-	-	-	
	Heating		-	-	-	-	-	-	-	-	
Moisture Removal			-	-	-	-	-	-	-		
Sound Pressure Level	Indoor (Cooling)	H/M/L/Q	38/-/-/-	42/-/-/-	41/-/-/-	45/-/-/-	44/40/37/32	45/41/39/34	44/40/37/32	45/41/39/34	
	Indoor (Heating)	H/M/L/Q	38/-/-/-	42/-/-/-	41/-/-/-	45/-/-/-	44/40/37/32	45/41/39/34	44/40/37/32	45/41/39/34	
Sound Power Level	Outdoor(Cooling/Heating)	High	51/52	52/53	54/55	53/55	55/55	58/59	55/55	58/59	
	Indoor(Cooling/Heating)	High	53/53	57/57	56/56	60/60	59/59	60/60	59/59	60/60	
Airflow Rate	Outdoor(Cooling/Heating)	High	63/64	64/65	66/67	68/69	70/70	72/73	70/70	72/73	
	Indoor / Outdoor (Cooling)	High	840/1,710	900/2,240	1,230/2,885	1,400/3,750	1,850/3,750	1,900/4,450	1,850/3,750	1,900/4,450	
Net Dimensions H x W x D	Indoor / Outdoor (Heating)	High	840/1,840	900/2,240	1,230/2,350	1,400/3,750	1,800/3,750	1,850/4,450	1,850/3,750	1,850/4,450	
	Indoor	mm	235×1,080×705	235×1,080×705	235×1,080×705	235×1,390×705	235×1,700×705	235×1,700×705	235×1,700×705	235×1,700×705	
Weight	Outdoor	mm	542×799×290	632×799×290	632×799×290	788×940×320	788×940×320	988×940×320	788×940×320	998×940×320	
	Indoor	kg(lbs)	24(53)	24(53)	31(68)	31(68)	38(84)	38(84)	38(84)	38(84)	
Weight	Outdoor	kg(lbs)	33(73)	36(79)	38(84)	52(115)	52(115)	61(134)	53(117)	62(137)	
			NO CONTROLLER SUPPLIED WITH THESE UNITS PLEASE ORDER SEPARATELY								
Remote Controller Type (NOT Supplied With Unit)			3 Core +Earth								
Interconnecting Cable (Suggested cable size 2.5mm)			3 Core +Earth								
Suggested MCB Size	Amp		13	16	20	25	25	32	16	16	
Max. Operating Current	Cooling/Heating		A	10.1/10.1	11.6/11.6	12.6/12.6	22.5/22.5	22.5/22.5	28.1/28.1	10.5/10.5	13.6/13.6
Power Supply To			Outdoor								
Connection Pipe Diameter (Gas / Liquid)	Inch		1/2 & 1/4	1/2 & 1/4	1/2 & 1/4	5/8 & 3/8	5/8 & 3/8	5/8 & 3/8	5/8 & 3/8	5/8 & 3/8	
Max Pipe Length (Pre-Charge)	m		20(15)	25(15)	25(20)	30(30)	30(30)	50(30)	30(30)	50(30)	
Max Height Difference			15	20	20	30	30	30	30	30	
Refrigerant	Type	R32		R32	R32	R32	R32	R32	R32	R32	
	Charge	g	900	1100	1250	1900	1900	2700	1900	2700	
Operation Range	Additional Charge	g/m	20	20	20	-	-	-	-	-	
	Cooling	°CDB	-10 to 46	-10 to 46	-10 to 46	-10 to 46	-10 to 46	-10 to 46	-10 to 46	-10 to 46	
Heating	-15 to 24		-15 to 24	-15 to 24	-15 to 24	-15 to 24	-15 to 24	-15 to 24	-10 to 24	-15 to 24	

## Easy maintenance

The front panel can be opened without removing the whole unit for safe & speedy maintenance.



The drain pan can be taken off for cleaning.



Components in the control box can be easily accessed.







# Light Commercial & Residential MULTI-SPLIT

- 066 Outdoor Units Lineup
- 068 2-unit to 6-unit Multi-split Connectable Indoor Units
- 096 Simultaneous Multi-split Connectable Indoor Units
- 102 Feature Explanation & Summary



## Refrigerant type R32 models

- 070 2-unit Multi-split
- 098 Simultaneous Multi-split Twin/Triple
- 
- 076 2-unit Multi-split Indoor Units Specifications
- 
- 080 2-unit Multi-split Combination Table



## Refrigerant type R410A models

- 2-unit to 6-unit Multi-split**
- 072 2-unit, 3-unit, 4-unit Multi-split
- 074 5-unit, 6-unit Multi-split

## Simultaneous Multi-split

- 100 Simultaneous Multi-split Twin/Triple/Quad
- 
- 078 2-unit to 6-unit Multi-split Indoor Units Specifications
- 
- 081 2-unit to 6-unit Multi-split Combination Table

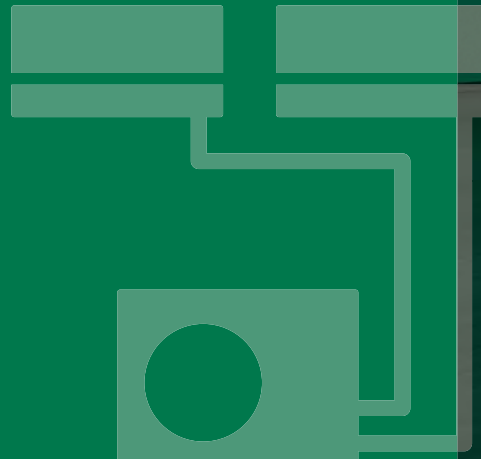













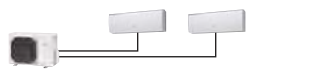





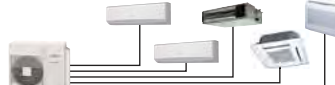







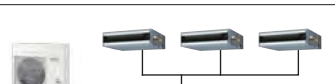

Control several indoor units with one outdoor unit. Build the system you desire.

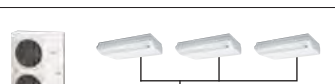
If you want to keep a large floor as well as many rooms comfortable, we recommend to use our Multi-split to build a compact system using just one outdoor unit. Choose from a large lineup of indoor units, which match up well to your rooms. You can mix and match them as you like. Build the system that is just right for you.

# Outdoor Units Lineup

				Class	14	18
				Cooling rated capacity(kw)	4.0	5.0
2-unit, 3-unit, 4-unit Multi-split	2-unit Multi-split Up to 2 units				AOYG14KBT2	AOYG18KBT2
					AOYG14LAC2	AOYG18LAC2
	3-unit Multi-split Up to 3 units					
						
5-unit, 6-unit Multi-split	5-unit Multi-split Up to 5 units					
	6-unit Multi-split Up to 6 units					
Simultaneous Multi-split	Twin Single phase					
	Twin 3 phase					
	Twin/Triple Single phase					
	Twin/Triple 3 phase					
	Twin/Triple Single phase					
	Twin/Triple 3 phase					
	Twin/Triple/ Quad 3 phase					

Note: **1. 2-unit Multi-split:** Connectable indoor units are 2 units.  
 AOYG14KBT2: Total capacity of indoor units connected must be between 4.0 kW and 6.0 kW.  
 AOYG18KBT2: Total capacity of indoor units connected must be between 4.0 kW and 7.5kW.  
 AOYG14LAC2: Total capacity of indoor units connected must be between 4.0 kW and 6.0 kW.  
 AOYG18LAC2: Total capacity of indoor units connected must be between 4.0 kW and 7.0 kW.

**2. 3-unit Multi-split:** Connectable indoor units are 2 to 3 units.  
 AOYG18LAT3: Total capacity of indoor units connected must be between 4.0 kW and 8.5 kW.  
 AOYG24LAT3: Total capacity of indoor units connected must be between 4.0 kW and 10.5 kW.  
**3. 4-unit Multi-split:** Connectable indoor units are 3 to 4 units.  
 AOYG30LAT4: Total capacity of indoor units connected must be between 7.5 kW and 14.0 kW.

18	24	30	36	45		54	72	90
5.4	6.8	8.0	10.0	12.5	14.0	14.0	19.0	22.0
AOYG18LAT3*	AOYG24LAT3*							
		AOYG30LAT4*						
			AOYG36LBLA5*					
				AOYG45LBLA6*				
			AOYG36KBTB	AOYG45KBTB				
			AOYG36KRTA	AOYG45KRTA				
						AOYG54KBTB		
						AOYG54KRTA		
			AOYG36LBTB	AOYG45LBTB*1		AOYG54LBTB*2		
			AOYG36LATT	AOYG45LATT		AOYG54LATT		
							AOYG72LRLA	AOYG90LRLA

**4. 5-unit Multi-split:** Connectable indoor units are 2 to 5 units

AOYG36LBLA5: Total capacity of indoor units connected must be between 7.5 kW and 15.5 kW.

**5. 6-unit Multi-split:** Connectable indoor units are 2 to 6 units









AOYG45LBLA6: Total capacity of indoor units connected must be between 9.5 kW and 18.0 kW.



FUJITSU GENERAL (Euro) GmbH participates in the ECP programme for AIR CONDITIONERS. Check ongoing validity of certificate: [www.eurovent-certification.com](http://www.eurovent-certification.com)  
\* Models so marked are not ECC certified.

# 2-unit to 6-unit Multi-split Connectable Indoor Units



Type		2-unit		
Model name		AOYG14KBTA2	AOYG18KBTA2	
Multi-split Type Outdoor Unit				
Capacity (kW)		Cooling	Heating	
		4.0	5.0	
		4.4	5.6	
Indoor Unit	BTU	kW Class		
 ASYG 07/09/12/14 KGTB  ASYG 07/09/12/14 KETA  ASYG 07/09/12/14 KMCC  ASYG 07/09/12/14 KETA-B	7,000	2.0	●	●
	9,000	2.5	●	●
	12,000	3.5	●	●
	14,000	4.0	—	●
 AUXG07/09/12/14KVLA	7,000	2.0	●	●
	9,000	2.5	●	●
	12,000	3.5	●	●
	14,000	4.0	—	●
 ARXG07/09/12/14KSLAP	7,000	2.0	●	●
	9,000	2.5	●	●
	12,000	3.5	●	●
	14,000	4.0	—	●
 ARXG07/09/12/14KLLAP	7,000	2.0	●	●
	9,000	2.5	●	●
	12,000	3.5	●	●
	14,000	4.0	—	●



Type	2-unit		3-unit		4-unit	5-unit	6-unit	
Model name	AOYG14LAC2	AOYG18LAC2	AOYG18LAT3	AOYG24LAT3	AOYG30LAT4	AOYG36LBA5	AOYG45LBA6	
Multi-split Type Outdoor Unit								
Capacity (kW)	Cooling	4.0	5.0	5.4	6.8	8.0	10.0	12.5
	Heating	4.4	5.6	6.8	8.0	9.6	12.0	13.5

Indoor Unit	BTU	kW Class							
 ASYG07/09/12/14LMCE	7,000	2.0	●	●	●	●	●	●	●
	9,000	2.5	●	●	●	●	●	●	●
 ASYG07/09/12/14LUCA	12,000	3.5	●	●	●	●	●	●	●
	14,000	4.0	—	●	●	●	●	●	●
 ASYG18/24LF	18,000	5.0	—	—	—	●	●	●	●
	24,000	7.0	—	—	—	—	●	—	●
 ASYG07/09/12/14KMCC*	7,000	2.0	—	—	●	●	●	●	—
	9,000	2.5	—	—	●	●	●	●	—
	12,000	3.5	—	—	●	●	●	●	—
	14,000	4.0	—	—	●	●	●	●	—
 AGYG09/12/14LV	9,000	2.5	—	●	●	●	●	●	●
	12,000	3.5	—	●	●	●	●	●	●
	14,000	4.0	—	—	●	●	●	●	●
 AUYG07/09/12/14/18LV	7,000	2.0	—	●	●	●	●	●	●
	9,000	2.5	—	●	●	●	●	●	●
	12,000	3.5	—	●	●	●	●	●	●
	14,000	4.0	—	—	●	●	●	●	●
	18,000	5.0	—	—	—	●	●	●	●
 AGYG09/12/14LVCA	14,000	4.0	—	—	●	●	●	●	●
	18,000	5.0	—	—	—	●	●	●	●
 ARYG07/09/12/14/18SLAP	7,000	2.0	—	●	●	●	●	●	●
	9,000	2.5	—	●	●	●	●	●	●
	12,000	3.5	—	●	●	●	●	●	●
	14,000	4.0	—	—	●	●	●	●	●
	18,000	5.0	—	—	—	●	●	●	●
 ARYG07/09/12/14/18LL	7,000	2.0	—	●	●	●	●	●	●
	9,000	2.5	—	●	●	●	●	●	●
	12,000	3.5	—	●	●	●	●	●	●
	14,000	4.0	—	—	●	●	●	●	●
	18,000	5.0	—	—	—	●	●	●	●

\* When connecting 14 model to multi-split type outdoor unit for R410A refrigerant, Adapter H is required for its piping.

# 2-unit Multi-split



## High energy saving

DC technology is used for compressor, indoor / outdoor fan motor and inverter controlling.



SEER 8.7<sup>\*1</sup> SCOP 4.7

\*1: 14 model

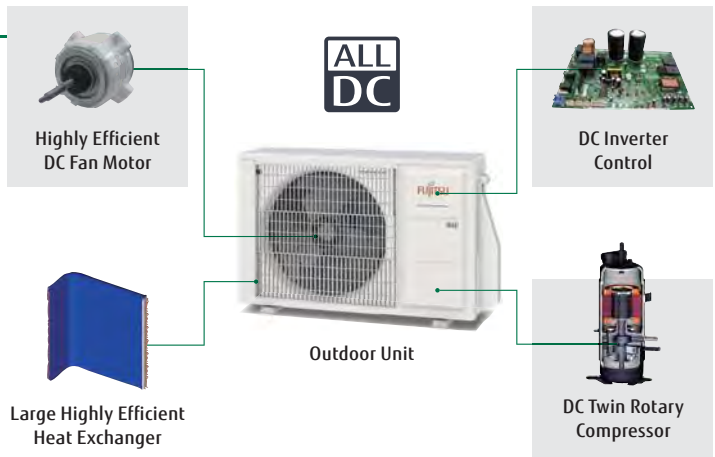

## Wide range of indoor units with various models

4 types / 16 models are lined up in the capacity range from 2.0 kW to 4.0 kW class. Wide range of requirements can be achieved in private homes, large shops and hotels.



### Models equipped with the New R32 Refrigerant

Wall mounted type with sophisticated design



Middle and small capacity models are available. This makes it easier to install at small spaces.



2-unit: AOYG14KBTA2 / AOYG18KBTA2



Specifications

Model No.			AOYG14KBTA2	AOYG18KBTA2
Power Source			Single phase, ~230V, 50Hz	
Nominal Capacity (min-max)	Cooling	kW	4.0 (1.4-4.6)	5.0 (1.7-5.8)
	Heating	kW	4.4 (1.1-5.5)	5.6 (1.8-6.6)
Power consumption				
EER	Cooling	W/W	4.12	4.03
	Heating	W/W	4.63	4.59
Pdesign			4.0 / 3.5	5.0 / 4.2
SEER	Cooling	W/W	8.70	8.60
	Heating (Average)	W/W	4.70	4.70
Energy Efficiency Class			A+++	A+++
Annual Energy Consumption	Cooling	kWh/a	209	263
	Heating	kWh/a	1296	1434
Sound Pressure Level (High)	Cooling	dB(A)	47	47
	Heating	dB(A)	49	50
Sound Power Level (High)	Cooling	dB(A)	60	60
	Heating	dB(A)	62	62
Airflow Rate			1,670/1,670	1,960/2,020
Net Dimensions H × W × D			542×799×290	632×799×290
Weight			33 (73)	37 (82)
Interconnecting Cable (Suggested cable size 1.5mm)			3 core + earth	
Suggested MCB Size			15	15
Max. Operating Current	Cooling/Heating	Amp	10.9	11.6
	Starting Current	Amp	4.7	5.6
Power Supply To			Outdoor unit	
Connection Pipe Diameter	Gas	Inch	3/8 × 2	3/8 × 2
	Liquid	Inch	1/4×2	1/4×2
Max. Pipe Length			30 / 20	30 / 20
Max. Height Difference	Between Outdoor Unit and Each Indoor Units.	m	15	15
	Between Indoor Units.	m	10	10
Refrigerant	Type		R32	R32
	Charge	g	900	1020
	Additional Charge	g/m	20	20
Operation Range	Cooling	°CDB	-10 to 46	-10 to 46
	Heating	°CDB	-15 to 24	-15 to 24

Dimensions

(Unit : mm)

AOYG14KBTA2

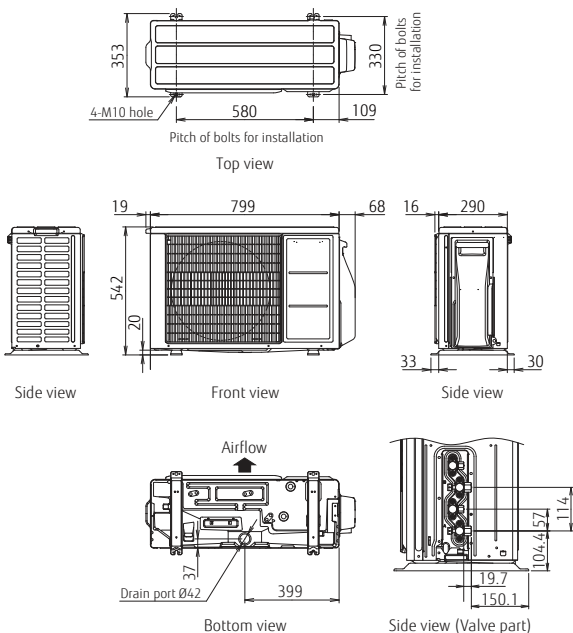

AOYG18KBTA2

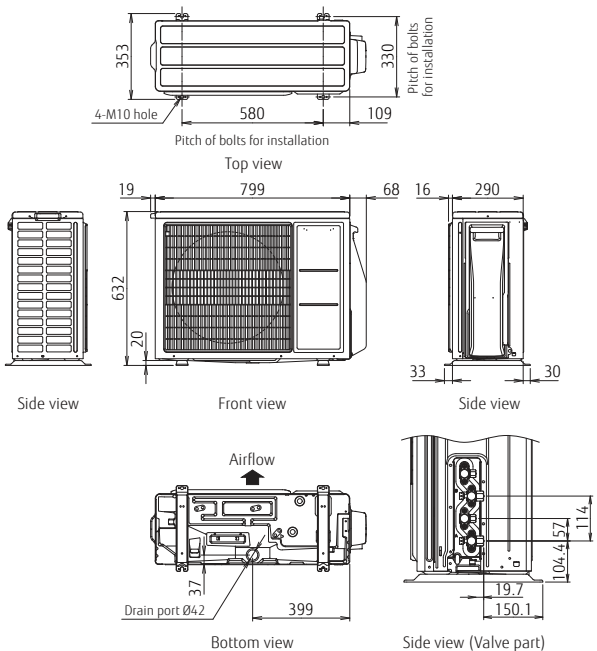

2-unit  
3-unit  
4-unit  
Multi-split

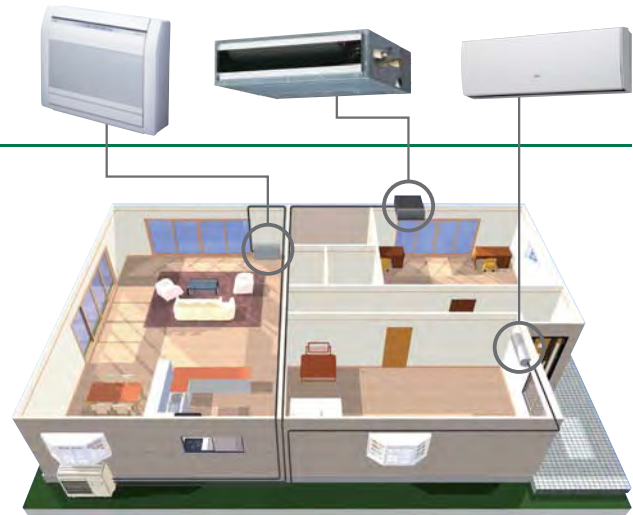

### Wide range of indoor units with various models

4 types / 16 models are available in the capacity range from 2.0 kW to 4.0 kW class. Wide range of requirements can be realised from in private homes, large shops and hotels.

### Space-saving installation

Multiple indoor units can be connected to 1 outdoor unit, and long piping connection is also possible. Compared with single type, the outdoor unit can be installed in various places to realise the space-saving installation.

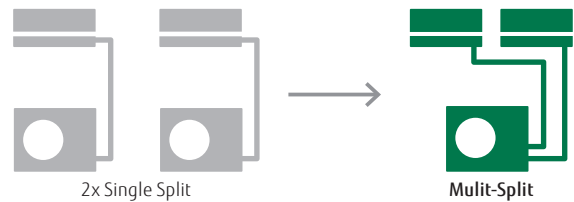

### Flexible installation

Up to max. piping length of 70 m (AOYG30LAT4), max. height difference of 15 m can be supported. Multi-split type can be installed in large-size residence or buildings with multiple floors.



**Max. Piping Length (Each Unit):**  
20 m: AOYG14LAC2/18LAC2,  
25 m: AOYG18LAT3/24LAT3/30LAT4

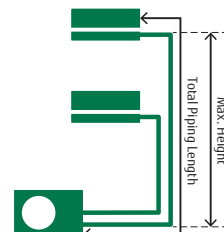

**Max. Height:**  
15 m: AOYG14LAC2/18LAC2/18LAT3/  
24LAT3/30LAT4

**Total Piping Length:**  
30 m: AOYG14LAC2/18LAC2,  
50 m: AOYG18LAT3/24LAT3,  
70 m: AOYG30LAT4



2-unit: AOYG14LAC2 / AOYG18LAC2  
 3-unit: AOYG18LAT3 / AOYG24LAT3  
 4-unit: AOYG30LAT4

**Specifications (2-unit, 3-unit, 4-unit)**

Model No.			AOYG14LAC2	AOYG18LAC2	AOYG18LAT3	AOYG24LAT3	AOYG30LAT4	
Power Source			Single phase, ~230V, 50Hz					
Nominal Capacity (min-max)	Cooling	kW	4.0 (1.4-4.4)	5.0 (1.7-5.6)	5.4 (1.8-6.8)	6.8 (1.8-8.5)	8.0 (3.5-10.1)	
	Heating		4.4 (1.1-5.4)	5.6 (1.8-6.1)	6.8 (2.0-8.0)	8.0 (2.0-9.2)	9.6 (3.7-12.0)	
Power Consumption	Cooling/Heating	kW	1.09/1.03	1.56/1.41	1.35/1.62	1.94/2.00	2.22/2.40	
EER	Cooling	W/W	3.67	3.21	4.00	3.51	3.60	
	Heating		4.27	3.97	4.20	4.00	4.00	
COP	Cooling/Heating(-10°C)	kW	4.00/3.80	5.00/4.20	5.40/5.00	6.80/5.20	8.00/6.20	
	Cooling		6.70	6.60	6.90	6.40	6.20	
SEER	Cooling	W/W	4.10	4.10	4.30	4.20	4.00	
	Heating (Average)		4.10	4.10	4.30	4.20	4.00	
Energy Efficiency Class	Cooling		A++	A++	A++	A++	A++	
	Heating (Average)		A+	A+	A+	A+	A+	
Annual Energy Consumption	Cooling	kWh/a	209	265	274	372	451	
	Heating		1296	1434	1627	1730	2169	
Sound Pressure Level (High)	Cooling	dB(A)	47	50	48	48	50	
	Heating		49	51	49	49	51	
Sound Power Level (High)	Cooling	dB(A)	61	63	65	68	68	
	Heating		63	64	67	70	70	
Airflow Rate	Cooling/Heating	m <sup>3</sup> /h	1,850/1,850	2,050/2,050	3,050/2,750	3,300/3,300	3,500/3,300	
Net Dimensions H × W × D			mm	540×790×290	540×790×290	700×900×330	700×900×330	830×900×330
Weight			kg(lbs)	37 (82)	38 (84)	55 (121)	55 (121)	68 (150)
Interconnecting Cable (Suggested cable size 1.5mm)			3 Core + Earth					
Suggested MCB Size			Amp	16	16	16	16	20
Max. Operating Current	Cooling/Heating	Amp	5.12/4.91	6.90/6.30	5.90/7.10	8.50/8.80	9.70/10.50	
			4.90	6.30	7.10	8.80	10.50	
Starting Current			Amp	4.90	6.30	7.10	8.80	10.50
Power Supply To			Outdoor					
Connection Pipe Diameter	Gas	Inch	3/8 × 2	3/8 × 2	3/8 × 2 & 1/2 × 1	3/8 × 2 & 1/2 × 1	3/8 × 2 & 1/2 × 2	
	Liquid		1/4 × 2	1/4 × 2	1/4 × 3	1/4 × 3	1/4 × 4	
Max. Pipe Length	Total / Each		30 / 20	30 / 20	50 / 25	50 / 25	70 / 25	
Max. Height Difference	Between Outdoor Unit and Each Indoor Units.		m	15	15	15	15	15
	Between Indoor Units.			10	10	10	10	10
Refrigerant	Type	R410A						
	Charge	g	1,250	1,300	2,200	2,200	3,300	
	Additional Charge	g/m	10	20	20	20	25	
Operation Range	Cooling	°CDB	10 to 46	10 to 46	-10 to 46	-10 to 46	0 to 46	
	Heating		-15 to 24	-15 to 24	-15 to 24	-15 to 24	-10 to 24	

**Dimensions**

(Unit : mm)

**2-unit:  
AOYG14LAC2/AOYG18LAC2**

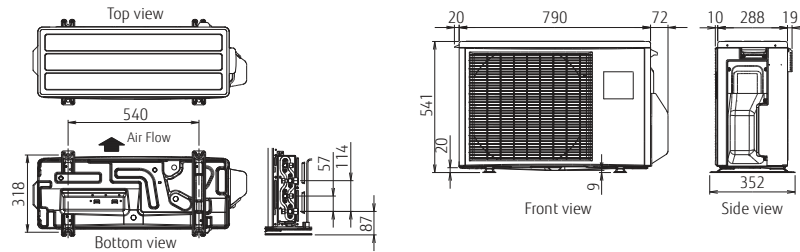

**3-unit:  
AOYG18LAT3/AOYG24LAT3**

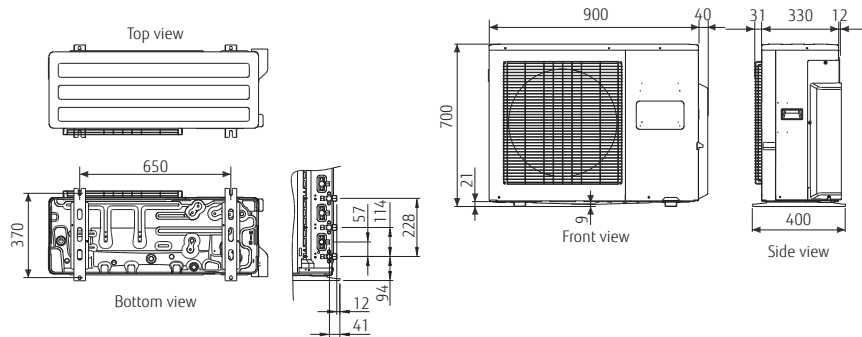

**4-unit:  
AOYG30LAT4**

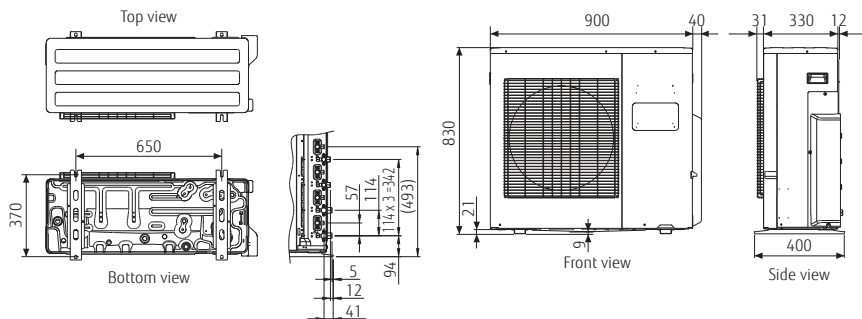

5-unit  
6-unit  
Multi-split



### Wide range of indoor units with various models

4 types / 16 models are available in the capacity range from 2.0 kW to 4.0 kW class. Wide range of requirements can be realised from in private homes, large shops and hotels.



### Compact design

Multiple indoor units can be connected to 1 outdoor unit, and long piping connection is also possible. Compared with single type, the outdoor unit can be installed in various places to realise the space-saving installation.



### Easy installation

All connected pipes and indoor units can be evacuated quickly via our centralised valve method. Requires evacuation only once

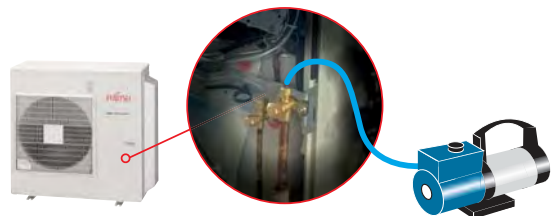

### Central & Individual Control

- Batched control of up to 6 indoor units. The temperature, airflow volume, and remote control prohibition settings of all indoor units can be batched.
- Corresponds to 9 different languages (English, German, French, Spanish, Russian, Portuguese, Italian, Greek, and Turkish)
- Large backlight LED screen
- Large easy-to-see operation panel

Max. Controllable  
**1 multi system**

Max. Controllable  
**6 indoor units**

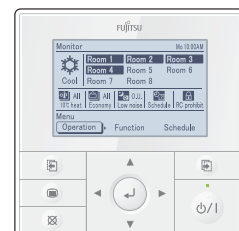

5-unit: AOYG36LBLA5  
6-unit: AOYG45LBLA6



### Specifications (5-unit, 6-unit)

Model No.			AOYG36LBLA5	AOYG45LBLA6
Power Source			Single phase, ~230V, 50Hz	
Nominal Capacity (min-max)	Cooling	kW	10.0 (3.5-12.5)	12.5 (3.5-14.0)
	Heating		12.0 (3.5-14.0)	13.5 (3.5-16.0)
Power Consumption	Cooling/Heating	kW	2.44/2.79	3.57/3.37
EER	Cooling	W/W	4.10	3.50
COP	Heating		4.30	4.00
Pdesign	Cooling/Heating(-10°C)	kW	10.00/9.00	12.50/10.00
SEER	Cooling	W/W	7.00	6.71 (LOT21)
SCOP	Heating (Average)		4.40	4.12 (LOT21)
Energy Efficiency Class	Cooling		A++	-
	Heating (Average)		A+	-
Annual Energy Consumption	Cooling	kWh/a	500	-
	Heating		2859	-
Sound Pressure Level (High)	Cooling	dB(A)	53	53
	Heating		55	55
Sound Power Level (High)	Cooling		67	67
	Heating		68	68
Airflow Rate	Cooling/Heating	m <sup>3</sup> /h	4,200/4,200	4,200/4,200
Net Dimensions H × W × D			998×970×370	998×970×370
Weight			94 (207)	94 (207)
Interconnecting Cable (Suggested cable size 1.5mm)			Upto 5 x 3 Core + Earth	Upto 5 x 3 Core + Earth
Suggested MCB Size			25	30
Max. Operating Current	Cooling/Heating	Amp	20.6	24
			12.30	15.70
Starting Current			12.30	15.70
Power Supply To			Outdoor	
Connection Pipe Diameter	Gas	Inch	3/8 × 3 & 1/2 × 2	3/8 × 4 & 1/2 × 2
	Liquid		1/4 × 5	1/4 × 6
Max. Pipe Length	Total / Each		80 / 25	80 / 25
Max. Height Difference	Between Outdoor Unit and Each Indoor Units.	m	15	15
	Between Indoor Units.		10	10
Refrigerant	Type		R410A	R410A
	Charge	g	4,000	4,000
	Additional Charge	g/m	20	20
Operation Range	Cooling	°CDB	-10 to 46	-10 to 46
	Heating		-15 to 24	-15 to 24

### Dimensions

(Unit : mm)

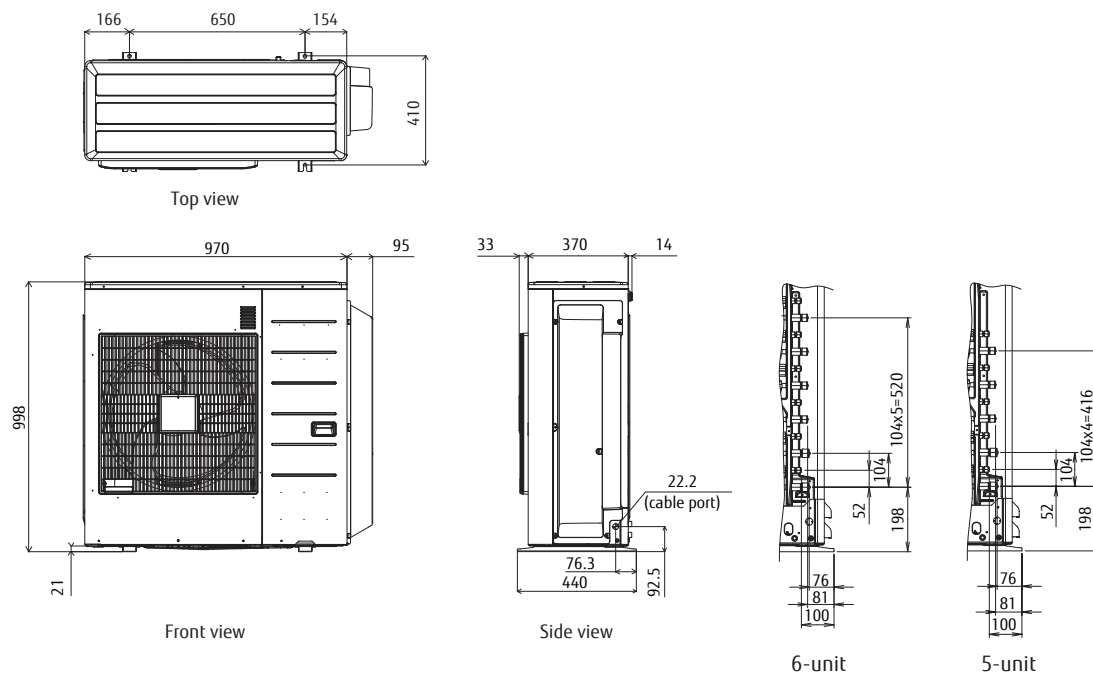

# New 2-unit Multi-split Indoor Units Specifications

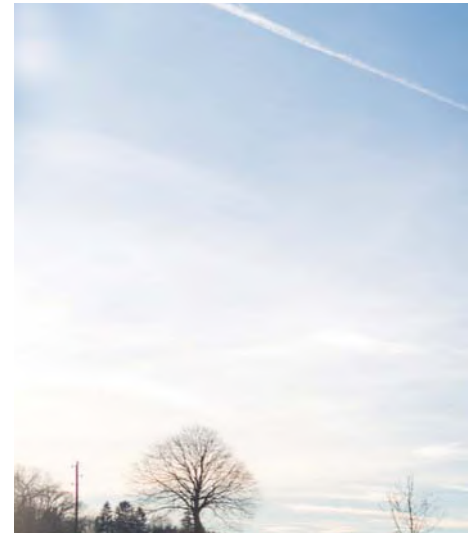

## Wall mounted



Model No.	Indoor unit			ASYG07KGTB	ASYG09KGTB	ASYG12KGTB	ASYG14KGTB
kW Class	kW			2.0	2.5	3.5	4.0
Power Source	Single phase, ~230V, 50Hz						
Sound Pressure Level	Cooling	H/M/L/Q	dB(A)	38/33/29/21	40/34/29/21	40/35/30/21	43/36/30/21
	Heating			41/35/31/22	42/36/31/22	42/38/33/22	44/39/33/24
Sound Power Level	Cooling	H	dB(A)	54	55	55	57
	Heating			56	57	58	59
Airflow Rate	Cooling	H/M/L/Q	m³/h	650/540/430/270	700/560/430/270	700/560/430/270	770/600/450/280
	Heating			720/580/460/330	750/610/470/330	770/640/520/330	800/660/520/340
Net Dimensions	mm			270x834x215	270x834x215	270x834x215	270x834x215
Weight	kg(lbs)			10 (22)	10 (22)	10 (22)	10 (22)
Connection Pipe Diameter	Liquid/Gas	mm		6.35/9.52	6.35/9.52	6.35/9.52	6.35/9.52

## Wall mounted



Model No.	Indoor unit			ASYG07KETA ASYG07KETA-B	ASYG09KETA ASYG09KETA-B	ASYG12KETA ASYG12KETA-B	ASYG14KETA ASYG14KETA-B
kW Class	kW			2.0	2.5	3.5	4.0
Power Source	Single phase, ~230V, 50Hz						
Sound Pressure Level	Cooling	H/M/L/Q	dB(A)	38/33/29/21	40/34/29/21	40/35/30/21	43/36/30/21
	Heating			41/35/31/22	42/36/31/22	42/38/33/22	44/39/33/24
Sound Power Level	Cooling	H	dB(A)	55	55	55	57
	Heating			56	57	58	59
Airflow Rate	Cooling	H/M/L/Q	m³/h	650/540/430/270	700/560/430/270	700/560/430/270	770/600/450/280
	Heating			720/580/460/330	750/610/470/330	770/640/520/330	800/660/520/340
Net Dimensions	mm			295x950 (wall side : 840) x230			
Weight	kg(lbs)			11(24)	11(24)	11(24)	11.5(25)
Connection Pipe Diameter	Liquid/Gas	mm		6.35/9.52	6.35/9.52	6.35/9.52	6.35/9.52

## Wall mounted



Model No.	Indoor unit			ASYG07KMCC	ASYG09KMCC	ASYG12KMCC	ASYG14KMCC
kW Class	kW			2.0	2.5	3.5	4.0
Power Source	Single phase, ~230V, 50Hz						
Sound Pressure Level	Cooling	H/M/L/Q	dB(A)	38/33/29/21	40/34/29/21	40/35/30/21	43/36/30/21
	Heating			41/35/31/22	42/36/31/22	42/38/33/22	44/39/33/24
Sound Power Level	Cooling	H	dB(A)	55	55	55	57
	Heating			56	57	58	59
Airflow Rate	Cooling	H/M/L/Q	m³/h	650/540/430/320	700/560/430/320	700/560/430/320	770/600/450/310
	Heating			720/580/460/330	750/610/470/330	780/640/520/330	820/660/520/340
Net Dimensions	mm			270x834x222	270x834x222	270x834x222	270x834x222
Weight	kg(lbs)			10 (22)	10 (22)	10 (22)	10 (22)
Connection Pipe Diameter	Liquid/Gas	mm		6.35/9.52	6.35/9.52	6.35/9.52	6.35/9.52



### Compact cassette Grid type



Model No.	Indoor unit			AUXG07KVLA	AUXG09KVLA	AUXG12KVLA	AUXG14KVLA
kW Class			kW	2.0	2.5	3.5	4.0
Power Source	Single phase, ~230V, 50Hz						
Sound Pressure Level	Cooling	H/M/L/Q	dB(A)	33/31/29/27	33/31/29/27	37/34/31/28	38/35/32/29
	Heating			34/32/29/27	34/32/29/27	37/34/31/29	43/38/34/30
Sound Power Level	Cooling	H	dB(A)	46	46	49	50
	Heating			47	47	49	55
Airflow Rate	Cooling	H/M/L/Q	m <sup>3</sup> /h	540/490/440/390	540/490/440/390	610/530/470/410	680/580/490/410
	Heating			540/490/440/390	540/490/440/390	610/530/470/410	790/680/580/450
Net Dimensions	mm			245x570x570	245x570x570	245x570x570	245x570x570
Weight	kg(lbs)			15 (33)	15 (33)	15 (33)	15 (33)
Panel				UTG-UFYF-W	UTG-UFYF-W	UTG-UFYF-W	UTG-UFYF-W
Connection Pipe Diameter	Liquid/Gas	mm		6.35/9.52	6.35/9.52	6.35/9.52	6.35/9.52

### Mini duct



Model No.	Indoor unit			ARXG07KSLAP	ARXG09KSLAP	ARXG12KSLAP	ARXG14KSLAP
kW Class			kW	2.0	2.5	3.5	4.0
Power Source	Single phase, ~230V, 50Hz						
Sound Pressure Level	Cooling	H/M/L/Q	dB(A)	29/26/24/23	29/26/24/23	31/27/25/23	35/30/27/23
	Heating			29/26/24/23	29/26/24/23	31/27/25/23	35/30/27/23
Sound Power Level	Cooling	H	dB(A)	52	54	55	60
	Heating			53	56	57	62
Airflow Rate	Cooling	H/M/L/Q	m <sup>3</sup> /h	550/440/390/360	600/450/400/360	650/490/430/360	800/640/530/360
	Heating			550/440/390/360	600/450/400/360	650/490/430/360	800/640/530/360
Net Dimensions	mm			198x700x450	198x700x450	198x700x450	198x700x450
Weight	kg(lbs)			15.5 (34)	15.5 (34)	15.5 (34)	15.5 (34)
Connection Pipe Diameter	Liquid/Gas	mm		6.35/9.52	6.35/9.52	6.35/9.52	6.35/9.52
External static pressure	Pa			0 to 30	0 to 30	0 to 30	0 to 50
Drain pump	Standard						

### Slim duct



Model No.	Indoor unit			ARXG07KLLAP	ARXG09KLLAP	ARXG12KLLAP	ARXG14KLLAP
kW Class			kW	2.0	2.5	3.5	4.0
Power Source	Single phase, ~230V, 50Hz						
Sound Pressure Level	Cooling	H/M/L/Q	dB(A)	28/26/25/24	28/27/26/25	29/28/27/26	32/30/28/26
	Heating			28/26/25/24	28/26/25/24	29/28/27/24	32/30/28/25
Sound Power Level	Cooling	H	dB(A)	57	57	58	60
	Heating			57	57	58	60
Airflow Rate	Cooling	H/M/L/Q	m <sup>3</sup> /h	550/490/470/440	600/550/500/450	650/600/550/480	800/700/600/480
	Heating			550/490/470/440	600/550/500/450	650/600/550/480	800/700/600/480
Net Dimensions	mm			198x700x620	198x700x620	198x700x620	198x700x620
Weight	kg(lbs)			16 (35)	17 (37)	17 (37)	17 (37)
Connection Pipe Diameter	Liquid/Gas	mm		6.35/9.52	6.35/9.52	6.35/9.52	6.35/9.52
External static pressure	Pa			0 to 90	0 to 90	0 to 90	0 to 90
Drain pump	Standard						

# 2-unit to 6-unit Multi-split Indoor Units Specifications

## Wall mounted

NEW



Model No.	Indoor unit			ASYG07KMCC	ASYG09KMCC	ASYG12KMCC	ASYG14KMCC*
kW Class		kW		2.0	2.5	3.5	4.0
Power Source				Single phase, ~230V, 50Hz			
Sound Pressure Level	Cooling	H/M/L/Q	dB(A)	38/33/29/21	40/34/29/21	40/35/30/21	43/36/30/21
	Heating			41/35/31/22	42/36/31/22	42/38/33/22	44/39/33/24
Sound Power Level	Cooling	H	dB(A)	54	55	55	57
	Heating			56	57	58	59
Airflow Rate	Cooling	H/M/L/Q	m <sup>3</sup> /h	650/540/430/320	700/560/430/320	700/560/430/320	770/600/450/310
	Heating			720/580/460/330	750/610/470/330	780/640/520/330	820/660/520/340
Net Dimensions			mm	270x834x222		270x834x222	
Weight			kg(lbs)	10 (22)		10 (22)	
Connection Pipe Diameter		Liquid/Gas	mm	6.35/9.52		6.35/9.52	

\* When connecting 14 model to multi-split type outdoor unit for R410A refrigerant, Adapter H is required for its piping.

## Compact wall mounted



Model No.	Indoor unit			ASYG07LUCA	ASYG09LUCA	ASYG12LUCA	ASYG14LUCA
kW Class		kW		2.0	2.5	3.5	4.0
Power Source				Single phase, ~230V, 50Hz			
Sound Pressure Level	Cooling	H/M/L/Q	dB(A)	35/30/28/21	36/32/28/21	37/34/31/21	41/36/33/25
	Heating			35/30/28/21	36/32/28/21	37/34/31/21	41/36/34/27
Sound Power Level	Cooling	H	dB(A)	53	54	55	59
	Heating			53	54	55	59
Airflow Rate	Cooling	H/M/L/Q	m <sup>3</sup> /h	570/520/470/330	600/550/470/330	660/600/530/330	710/640/570/390
	Heating			570/520/470/330	600/550/470/330	660/600/530/330	710/640/590/430
Net Dimensions			mm	282x870x185		282x870x185	
Weight			kg(lbs)	9.5 (21)		9.5 (21)	
Connection Pipe Diameter		Liquid/Gas	mm	6.35/9.52		6.35/9.52	

## Wall mounted



Model No.	Indoor unit			ASYG18LFCA	ASYG24LFCC
kW Class		kW		5.0	7.0
Power Source				Single phase, ~230V, 50Hz	
Sound Pressure Level	Cooling	H/M/L/Q	dB(A)	43/37/33/26	49/42/37/33
	Heating			42/37/33/25	48/42/37/33
Sound Power Level	Cooling	H	dB(A)	58	64
	Heating			58	64
Airflow Rate	Cooling	H/M/L/Q	m <sup>3</sup> /h	900/740/620/550	1,120/900/740/620
	Heating			900/740/620/550	1,100/900/740/620
Net Dimensions			mm	320x998x238	
Weight			kg(lbs)	14 (31)	
Connection Pipe Diameter		Liquid/Gas	mm	6.35/12.70	

## Compact wall mounted



Model No.	Indoor unit			ASYG07LMCE	ASYG09LMCE	ASYG12LMCE	ASYG14LMCE
kW Class		kW		2.0	2.5	3.5	4.0
Power Source				Single phase, ~230V, 50Hz			
Sound Pressure Level	Cooling	H/M/L/Q	dB(A)	36/32/29/21	37/33/29/21	40/36/30/21	42/38/33/25
	Heating			36/32/29/22	37/33/29/22	40/36/31/22	42/38/35/27
Sound Power Level	Cooling	H	dB(A)	51	52	54	56
	Heating			51	52	55	57
Airflow Rate	Cooling	H/M/L/Q	m <sup>3</sup> /h	560/500/430/310	600/520/430/310	660/560/450/310	730/600/530/360
	Heating			560/500/430/330	600/520/430/330	660/560/470/330	730/615/560/375
Net Dimensions			mm	270x870x204		270x870x204	
Weight			kg(lbs)	8.5 (19)		8.5 (19)	
Connection Pipe Diameter		Liquid/Gas	mm	6.35/9.52		6.35/9.52	

## Floor



Model No.	Indoor unit			AGYG09LVCA	AGYG12LVCA	AGYG14LVCA	
kW Class		kW		2.5	3.5	4.0	
Power Source				Single phase, ~230V, 50Hz			
Sound Pressure Level	Cooling	H/M/L/Q	dB(A)	39/34/28/22	42/36/30/22	44/38/31/22	
	Heating			39/35/30/22	42/38/32/22	44/39/33/22	
Sound Power Level	Cooling	H	dB(A)	52	55	56	
	Heating			52	55	56	
Airflow Rate	Cooling	H/M/L/Q	m <sup>3</sup> /h	530/440/360/270	600/490/380/270	650/520/400/270	
	Heating			530/460/380/270	600/510/410/270	650/540/430/270	
Net Dimensions			mm	600x740x200		600x740x200	
Weight			kg(lbs)	14 (31)		14 (31)	
Connection Pipe Diameter		Liquid/Gas	mm	6.35/9.52		6.35/12.70	

**Floor ceiling**

Model No.	Indoor unit			ABYG14LVTA	ABYG18LVTB
kW Class	kW			4.0	5.0
Power Source	Single phase, ~230V, 50Hz				
Sound Pressure Level	Cooling	H/M/L/Q	dB(A)	36/34/33/29 (Under ceiling) 39/37/36/32 (Floor console)	41/38/34/32 (Under ceiling) 44/41/37/35 (Floor console)
	Heating			36/34/33/29 (Under ceiling) 39/37/36/32 (Floor console)	41/38/34/32 (Under ceiling) 44/41/37/35 (Floor console)
Sound Power Level	Cooling	H	dB(A)	51	55
	Heating			51	55
Airflow Rate	Cooling	H/M/L/Q	m <sup>3</sup> /h	640/590/540/480	780/700/560/500
	Heating			640/590/540/480	780/700/560/500
Net Dimensions	mm			199×990×655	199×990×655
Weight	kg(lbs)			27 (60)	27 (60)
Connection Pipe Diameter	Liquid/Gas	mm		6.35/12.70	6.35/12.70

**Compact cassette**

Model No.	Indoor unit			AUYG07LVLA	AUYG09LVLA	AUYG12LVLB	AUYG14LVLB	AUYG18LVLB
kW Class	kW			2.0	2.5	3.5	4.0	5.0
Power Source	Single phase, ~230V, 50Hz							
Sound Pressure Level	Cooling	H/M/L/Q	dB(A)	33/31/29/27	33/31/29/27	37/33/31/28	40/35/32/29	42/37/33/29
	Heating			34/32/29/27	34/32/29/27	37/33/31/28	40/37/34/29	44/40/37/30
Sound Power Level	Cooling	H	dB(A)	46	46	49	52	54
	Heating			47	47	49	52	56
Airflow Rate	Cooling	H/M/L/Q	m <sup>3</sup> /h	540/490/440/390	540/490/440/390	610/530/470/410	680/580/490/410	750/610/520/410
	Heating			540/490/440/390	540/490/440/390	610/530/470/410	700/620/550/430	800/710/600/450
Net Dimensions	mm			245×570×570	245×570×570	245×570×570	245×570×570	245×570×570
Weight	kg(lbs)			15(33)	15 (33)	15 (33)	15 (33)	15 (33)
Panel	UTG-UFYD-W							
Connection Pipe Diameter	Liquid/Gas	mm		6.35/9.52	6.35/9.52	6.35/9.52	6.35/12.70	6.35/12.70

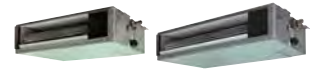
**Mini duct**

Model No.	Indoor unit			ARYG07LSLAP	ARYG09LSLAP	ARYG12LSLAP	ARYG14LSLAP	ARYG18LSLAP
kW Class	kW			2.0	2.5	3.5	4.0	5.0
Power Source	Single phase, ~230V, 50Hz							
Sound Pressure Level	Cooling	H/M/L/Q	dB(A)	29/26/24/23	29/26/24/23	31/27/25/23	35/30/27/23	33/29/26/23
	Heating			29/26/24/23	29/26/24/23	31/27/25/23	35/30/27/23	33/29/26/23
Sound Power Level	Cooling	H	dB(A)	52	54	55	60	58
	Heating			53	56	57	62	59
Airflow Rate	Cooling	H/M/L/Q	m <sup>3</sup> /h	550/440/390/360	600/450/400/360	650/490/430/360	800/640/530/360	940/750/540/480
	Heating			550/440/390/360	600/450/400/360	650/490/430/360	800/640/530/360	940/750/540/480
Net Dimensions	mm			198×700×450	198×700×450	198×700×450	198×700×450	198×900×450
Weight	kg(lbs)			15.5 (33)				18.5 (41)
Connection Pipe Diameter	Liquid/Gas	mm		6.35/9.52			6.35/12.70	
External static pressure	Pa			0 to 30			0 to 50	
Drain pump	Standard							

**Slim duct**

Model No.	Indoor unit			ARYG07LLTA	ARYG09LLTA	ARYG12LLTB	ARYG14LLTB	ARYG18LLTB
kW Class	kW			2.0	2.5	3.5	4.0	5.0
Power Source	Single phase, ~230V, 50Hz							
Sound Pressure Level	Cooling	H/M/L/Q	dB(A)	28/26/25/24	28/27/26/25	29/28/27/26	32/30/28/26	32/31/30/29
	Heating			28/26/25/24	28/26/25/24	29/28/27/24	33/30/28/25	33/32/31/29
Sound Power Level	Cooling	H	dB(A)	57	57	58	60	58
	Heating			57	57	58	61	59
Airflow Rate	Cooling	H/M/L/Q	m <sup>3</sup> /h	550/490/470/440	600/550/500/450	650/600/550/480	800/700/600/480	940/880/820/750
	Heating			550/490/470/440	600/550/500/450	650/600/550/480	800/700/600/480	940/880/820/750
Net Dimensions	mm			198×700×620	198×700×620	198×700×620	198×700×620	198×900×620
Weight	kg(lbs)			17 (37)	19 (42)	19 (42)	19 (42)	23 (51)
Connection Pipe Diameter	Liquid/Gas	mm		6.35/9.52	6.35/9.52	6.35/9.52	6.35/12.7	6.35/12.70
External static pressure	Pa			0 to 90				
Drain pump	Standard							

# 2-unit Multi-split Combination Table-Cooling/Heating



## 2-unit Multi-split cooling

AOYG14KBTA2	Combination of Indoor Unit		Cooling Operation						Seasonal Data		
			Cooling Capacity			Input Power (min-max)	EER	Pdesign	SEER	Energy efficiency class	
			Unit 1	Unit 2	Total Capacity (min-max)						
			kW	kW	kW	kW					
2-unit connection	7	7	2.00	2.00	4.00(1.4-4.6)	0.97(0.25 - 1.20)	4.12	4.0	8.7	A+++	
	7	9	1.75	2.25	4.00(1.4-4.6)	0.97(0.25 - 1.20)	4.12	4.0	8.7	A+++	
	7	12	1.47	2.53	4.00(1.4-4.6)	0.97(0.25 - 1.20)	4.12	4.0	8.7	A+++	
	9	9	2.00	2.00	4.00(1.4-4.6)	0.97(0.25 - 1.20)	4.12	4.0	8.7	A+++	
	9	12	1.71	2.29	4.00(1.4-4.6)	0.97(0.25 - 1.20)	4.12	4.0	8.7	A+++	

- Note:
- 7:7000Btu/h / 9:9000Btu/h / 12:12000Btu/h models
  - The above is the value for connecting with Wall Mounted [KG] type.
  - 2 or more indoor units should be connected.
  - Cooling capacity is based on 27°CDB/19°CWB (indoor temperature), 35°CDB (outdoor temperature).
  - Pipe Length: 5 m, Height difference: 0 m (Outdoor unit to Indoor unit)
  - The Total ability of connected indoor unit is up to 21000Btu from 14000Btu.

AOYG18KBTA2	Combination of Indoor Unit		Cooling Operation						Seasonal Data		
			Cooling Capacity			Input Power (min-max)	EER	Pdesign	SEER	Energy efficiency class	
			Unit 1	Unit 2	Total Capacity (min-max)						
			kW	kW	kW	kW					
2-unit connection	7	7	2.00	2.00	4.00(1.7-5.0)	0.92(0.25 - 1.23)	4.35	4.0	8.8	A+++	
	7	9	2.00	2.50	4.50(1.7-5.7)	1.07(0.25 - 1.45)	4.22	4.5	8.7	A+++	
	7	12	1.84	3.16	5.00(1.7-5.8)	1.24(0.25 - 1.55)	4.03	5.0	8.6	A+++	
	7	14	1.67	3.33	5.00(1.7-5.8)	1.24(0.25 - 1.55)	4.03	5.0	8.6	A+++	
	9	9	2.50	2.50	5.00(1.7-5.8)	1.24(0.25 - 1.55)	4.03	5.0	8.6	A+++	
	9	12	2.14	2.86	5.00(1.7-5.8)	1.24(0.25 - 1.55)	4.03	5.0	8.6	A+++	
	9	14	1.96	3.04	5.00(1.7-5.8)	1.24(0.25 - 1.55)	4.03	5.0	8.6	A+++	
	12	12	2.50	2.50	5.00(1.7-5.8)	1.24(0.25 - 1.55)	4.03	5.0	8.6	A+++	
12	14	2.31	2.69	5.00(1.7-5.8)	1.24(0.25 - 1.55)	4.03	5.0	8.6	A+++		

- Note:
- 7:7000Btu/h / 9:9000Btu/h / 12:12000Btu/h / 14:14000Btu/h models
  - The above is the value for connecting with Wall Mounted [KG] type.
  - 2 or more indoor units should be connected.
  - Cooling capacity is based on 27°CDB/19°CWB (indoor temperature), 35°CDB (outdoor temperature).
  - Pipe Length: 5 m, Height difference: 0 m (Outdoor unit to Indoor unit)
  - The Total ability of connected indoor unit is up to 26000Btu from 14000Btu.

## 2-unit Multi-split heating

AOYG14KBTA2	Combination of Indoor Unit		Heating Operation						Seasonal Data		
			Heating Capacity			Input Power (min-max)	COP	Pdesign	SCOP	Energy efficiency class	
			Unit 1	Unit 2	Total Capacity (min-max)						
			kW	kW	kW	kW					
2-unit connection	7	7	2.20	2.20	4.40(1.1-5.5)	0.95(0.25 - 1.65)	4.63	3.5	4.7	A++	
	7	9	1.92	2.48	4.40(1.1-5.5)	0.95(0.25 - 1.65)	4.63	3.5	4.7	A++	
	7	12	1.62	2.78	4.40(1.1-5.5)	0.95(0.25 - 1.65)	4.63	3.5	4.7	A++	
	9	9	2.20	2.20	4.40(1.1-5.5)	0.95(0.25 - 1.65)	4.63	3.5	4.7	A++	
	9	12	1.89	2.51	4.40(1.1-5.5)	0.95(0.25 - 1.65)	4.63	3.5	4.7	A++	

- Note:
- 7:7000Btu/h / 9:9000Btu/h / 12:12000Btu/h models
  - The above is the value for connecting with Wall Mounted [KG] type.
  - 2 or more indoor units should be connected.
  - Heating capacity is based on 20°CDB (indoor temperature), 7°CDB/6°CWB (outdoor temperature).
  - Pipe Length: 5 m, Height difference: 0 m (Outdoor unit to Indoor unit)
  - The Total ability of connected indoor unit is up to 21000Btu from 14000Btu.

AOYG18KBTA2	Combination of Indoor Unit		Heating Operation						Seasonal Data		
			Heating Capacity			Input Power (min-max)	COP	Pdesign	SCOP	Energy efficiency class	
			Unit 1	Unit 2	Total Capacity (min-max)						
			kW	kW	kW	kW					
2-unit connection	7	7	2.40	2.40	4.80(1.7-5.6)	0.99(0.25 - 1.35)	4.85	3.8	4.7	A++	
	7	9	2.40	3.00	5.40(1.7-6.4)	1.15(0.25 - 1.60)	4.70	4.0	4.7	A++	
	7	12	2.06	3.54	5.60(1.7-7.0)	1.22(0.25 - 1.80)	4.59	4.2	4.7	A++	
	7	14	1.87	3.73	5.60(1.7-7.0)	1.22(0.25 - 1.80)	4.59	4.2	4.7	A++	
	9	9	2.80	2.80	5.60(1.7-7.0)	1.22(0.25 - 1.80)	4.59	4.2	4.7	A++	
	9	12	2.40	3.20	5.60(1.7-7.0)	1.22(0.25 - 1.80)	4.59	4.2	4.7	A++	
	9	14	2.19	3.41	5.60(1.7-7.0)	1.22(0.25 - 1.80)	4.59	4.2	4.7	A++	
	12	12	2.80	2.80	5.60(1.7-7.0)	1.22(0.25 - 1.80)	4.59	4.2	4.7	A++	
	12	14	2.58	3.02	5.60(1.7-7.0)	1.22(0.25 - 1.80)	4.59	4.2	4.7	A++	

- Note:
- 7:7000Btu/h / 9:9000Btu/h / 12:12000Btu/h / 14:14000Btu/h models
  - The above is the value for connecting with Wall Mounted [KG] type.
  - 2 or more indoor units should be connected.
  - Heating capacity is based on 20°CDB (indoor temperature), 7°CDB/6°CWB (outdoor temperature).
  - Pipe Length: 5 m, Height difference: 0 m (Outdoor unit to Indoor unit)
  - The Total ability of connected indoor unit is up to 26000Btu from 14000Btu.





## 2-unit Multi-split cooling

AOYG14LAC2	Combination of Indoor Unit		Cooling Operation					Seasonal Data		
			Cooling Capacity			Input Power (min-max)	EER	Pdesign	SEER	Energy efficiency class
			Unit 1	Unit 2	Total Capacity (min-max)					
			kW	kW	kW	kW				
2-unit connection	7	7	2.00	2.00	4.00 (1.4 - 4.4)	1.09 (0.35 - 1.40)	3.67	4.0	6.7	A++
	7	9	1.95	2.05	4.00 (1.4 - 4.4)	1.09 (0.35 - 1.40)	3.67	4.0	6.6	A++
	7	12	1.65	2.35	4.00 (1.4 - 4.6)	1.05 (0.35 - 1.47)	3.81	4.0	6.5	A++
	9	9	2.00	2.00	4.00 (1.4 - 4.5)	1.09 (0.35 - 1.43)	3.67	4.0	6.6	A++
	9	12	1.70	2.30	4.00 (1.4 - 4.7)	1.05 (0.35 - 1.47)	3.81	4.0	6.5	A++

- Note:
- 7:7000Btu/h / 9:9000Btu/h / 12:12000Btu/h models
  - The above is the value for connecting with Wall Mounted type.
  - 2 or more indoor units should be connected.
  - Cooling capacity is based on 27°CDB/19°CWB (indoor temperature), 35°CDB (outdoor temperature).
  - Pipe Length: 5 m, Height difference: 0 m (Outdoor unit to Indoor unit)
  - The Total ability of connected indoor unit is up to 21000Btu from 14000Btu.

AOYG18LAC2	Combination of Indoor Unit		Cooling Operation					Seasonal Data		
			Cooling Capacity			Input Power (min-max)	EER	Pdesign	SEER	Energy efficiency class
			Unit 1	Unit 2	Total Capacity (min-max)					
			kW	kW	kW	kW				
2-unit connection	7	7	2.10	2.10	4.20 (1.7 - 5.2)	1.24 (0.35 - 1.68)	3.39	4.2	7.0	A++
	7	9	2.10	2.50	4.60 (1.7 - 5.3)	1.26 (0.35 - 1.79)	3.65	4.6	6.8	A++
	7	12	1.90	3.10	5.00 (1.7 - 5.6)	1.55 (0.35 - 1.95)	3.23	5.0	6.5	A++
	7	14	1.80	3.20	5.00 (1.8 - 5.7)	1.55 (0.40 - 1.99)	3.23	5.0	6.5	A++
	9	9	2.50	2.50	5.00 (1.7 - 5.6)	1.56 (0.35 - 1.95)	3.21	5.0	6.6	A++
	9	12	2.10	2.90	5.00 (1.7 - 5.7)	1.55 (0.35 - 1.95)	3.23	5.0	6.5	A++
	9	14	2.00	3.00	5.00 (1.8 - 5.8)	1.55 (0.40 - 1.99)	3.23	5.0	6.4	A++
	12	12	2.50	2.50	5.00 (1.7 - 5.8)	1.56 (0.35 - 1.99)	3.21	5.0	6.4	A++

- Note:
- 7:7000Btu/h / 9:9000Btu/h / 12:12000Btu/h / 14:14000Btu/h models
  - The above is the value for connecting with Wall Mounted type.
  - 2 or more indoor units should be connected.
  - Cooling capacity is based on 27°CDB/19°CWB (indoor temperature), 35°CDB (outdoor temperature).
  - Pipe Length: 5 m, Height difference: 0 m (Outdoor unit to Indoor unit)
  - The Total ability of connected indoor unit is up to 24000Btu from 14000Btu.
  - Where "14" means "wall mounted type" only models. Other types of indoor units cannot be connected.

## 2-unit Multi-split heating

AOYG14LAC2	Combination of Indoor Unit		Heating Operation					Seasonal Data		
			Heating Capacity			Input Power (min-max)	COP	Pdesign	SCOP	Energy efficiency class
			Unit 1	Unit 2	Total Capacity (min-max)					
			kW	kW	kW	kW				
2-unit connection	7	7	2.20	2.20	4.40 (1.1 - 5.4)	1.03 (0.25 - 1.78)	4.27	3.8	4.1	A+
	7	9	2.15	2.25	4.40 (1.1 - 5.4)	1.03 (0.25 - 1.78)	4.27	3.8	4.1	A+
	7	12	1.95	2.45	4.40 (1.1 - 5.5)	1.02 (0.25 - 1.76)	4.31	3.8	4.0	A+
	9	9	2.20	2.20	4.40 (1.1 - 5.4)	1.03 (0.25 - 1.78)	4.27	3.8	4.0	A+
	9	12	2.00	2.40	4.40 (1.1 - 5.5)	1.02 (0.25 - 1.76)	4.31	3.8	4.0	A+

- Note:
- 7:7000Btu/h / 9:9000Btu/h / 12:12000Btu/h models
  - The above is the value for connecting with Wall Mounted type.
  - 2 or more indoor units should be connected.
  - Heating capacity is based on 20°CDB (indoor temperature), 7°CDB/6°CWB (outdoor temperature).
  - Pipe Length: 5 m, Height difference: 0 m (Outdoor unit to Indoor unit)
  - The Total ability of connected indoor unit is up to 21000Btu from 14000Btu.

AOYG18LAC2	Combination of Indoor Unit		Heating Operation					Seasonal Data		
			Heating Capacity			Input Power (min-max)	COP	Pdesign	SCOP	Energy efficiency class
			Unit 1	Unit 2	Total Capacity (min-max)					
			kW	kW	kW	kW				
2-unit connection	7	7	2.70	2.70	5.40 (1.8 - 6.0)	1.24 (0.50 - 1.61)	4.37	4.0	4.1	A+
	7	9	2.50	3.00	5.50 (1.8 - 6.0)	1.36 (0.50 - 1.87)	4.04	4.0	4.1	A+
	7	12	2.30	3.30	5.60 (1.8 - 6.1)	1.38 (0.50 - 1.88)	4.06	4.2	4.0	A+
	7	14	2.25	3.35	5.60 (1.9 - 6.2)	1.35 (0.55 - 1.86)	4.15	4.2	4.0	A+
	9	9	2.80	2.80	5.60 (1.8 - 6.1)	1.41 (0.50 - 1.90)	3.97	4.2	4.1	A+
	9	12	2.45	3.15	5.60 (1.8 - 6.2)	1.38 (0.50 - 1.88)	4.07	4.2	4.0	A+
	9	14	2.35	3.25	5.60 (1.9 - 6.3)	1.35 (0.55 - 1.86)	4.15	4.2	4.0	A+
	12	12	2.80	2.80	5.60 (1.8 - 6.3)	1.34 (0.50 - 1.84)	4.18	4.2	4.0	A+

- Note:
- 7:7000Btu/h / 9:9000Btu/h / 12:12000Btu/h / 14:14000Btu/h models
  - The above is the value for connecting with Wall Mounted type.
  - 2 or more indoor units should be connected.
  - Heating capacity is based on 20°CDB (indoor temperature), 7°CDB/6°CWB (outdoor temperature).
  - Pipe Length: 5 m, Height difference: 0 m (Outdoor unit to Indoor unit)
  - The Total ability of connected indoor unit is up to 24000Btu from 14000Btu.
  - Where "14" means "wall mounted type" only models. Other types of indoor units cannot be connected.





























### 6-unit Multi-split heating

AOYG45LBLA6	Combination of Indoor Unit						Heating Operation						COP		
							Heating Capacity							Input Power (min-max)	COP
							Unit 1	Unit 2	Unit 3	Unit 4	Unit 5	Unit 6			

- Note:
- 7:7000Btu/h / 9:9000Btu/h / 12:12000Btu/h / 14:14000Btu/h / 18:18000Btu/h / 24:24000Btu/h models
  - The above is the value for connecting with Wall Mounted type.
  - 2 or more indoor units should be connected.
  - Heating capacity is based on 20°CDB (indoor temperature), 7°CDB/6°CWB (outdoor temperature).
  - Pipe Length: 5 m, Height difference: 0 m (Outdoor unit to Indoor unit)
  - The Total ability of connected indoor unit is up to 54000Btu from 27000Btu.

# Simultaneous Multi-split Connectable Indoor Units



Type	4HP		5HP		6HP	
Model name	AOYG36KBTB	AOYG36KRTA	AOYG45KBTB	AOYG45KRTA	AOYG54KBTB	AOYG54KRTA
Simultaneous Multi-split Outdoor Unit						
Capacity (kW)	Cooling	9.5	12.1	13.4	13.4	13.4
	Heating	10.8	13.5	15.5	15.5	15.5

Indoor Unit	BTU	kW Class	Twin			Triple
 AUXG18/22/24KVLA	18,000	5.0	● ×2	–	–	● ×3
	22,000	6.5	–	● ×2	–	–
	24,000	7.0	–	–	● ×2	–
 ARXG18KLLAP	18,000	5.0	● ×2	–	–	● ×3
	22,000	6.5	–	● ×2	–	–
 ARXG22/24KMLA	24,000	7.0	–	–	● ×2	–
	Separation tube		UTP-SX236A (18/22/24)			UTP-SX354A (18)





Type		8HP		10HP			
Model name		AOYG72LRLA		AOYG90LRLA			
Simultaneous Multi-split Outdoor Unit							
Capacity (kW)	Cooling	19.0		22.0			
	Heating	22.4		27.0			
Indoor Unit	BTU	kW Class	Twin	Triple	Double Twin	Twin	Triple
 AUYG18/24LV	18,000	5.0	–	–	● ×4	–	–
	24,000	7.0	–	● ×3	–	–	–
 AUYG30/36/45LR	30,000	8.8	–	–	–	–	● ×3
	36,000	10.6	● ×2	–	–	–	–
	45,000	12.5	–	–	–	● ×2	–
 ARYG18LLTB	18,000	5.0	–	–	● ×4	–	–
 ARYG24/ 30/36/45LM	24,000	7.0	–	● ×3	–	–	–
	30,000	8.8	–	–	–	–	● ×3
	36,000	10.6	● ×2	–	–	–	–
	45,000	12.5	–	–	–	● ×2	–
 ABYG18/24LV	18,000	5.0	–	–	● ×4	–	–
	24,000	7.0	–	● ×3	–	–	–
 ABYG30/36/45LR	30,000	8.8	–	–	–	–	● ×3
	36,000	10.6	● ×2	–	–	–	–
	45,000	12.5	–	–	–	● ×2	–
Separation tube			UTP-SX272A x1	UTP-SX372A x1	UTP-SX272A x 1, UTP-SX236A x 2	UTP- SX272A x1	UTP- SX372A x1

# Simultaneous Multi-split Twin/Triple



Supports various installation scenes from office to commercial space, inside the same room and multi connection of up to 3 indoor units.

Selection of indoor units according to the room shape and heat load, like number of people and lighting conditions. Most comfortable air flow distribution can be realized.

Installation according to floor layout

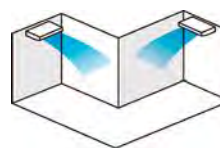

Installation according to lighting conditions

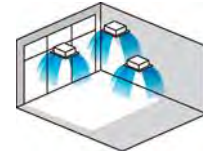

## Design flexibility

### Slim & Compact design

This model is much more compact than a conventional outdoor unit. Significant reduced height of the product supports installations in narrow spaces.

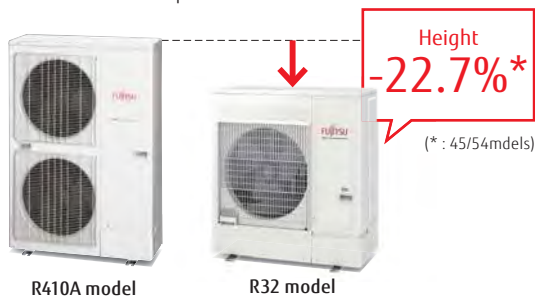

## Flexible installation

Up to max. piping length of 50 m, max. height difference of 30 m can be supported. Multi-split type can be installed in large-size residence or buildings with multiple floors.

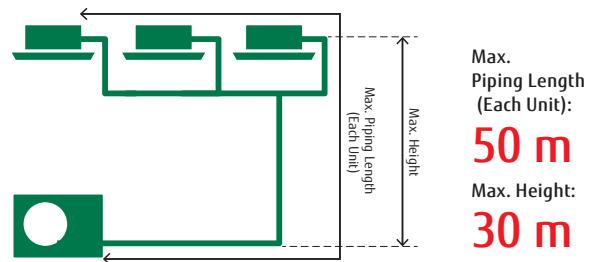

## Simultaneous Operation Multi type Indoor Unit Line up

	Twin			Triple
	18x2	22x2	24x2	18x3
Cassette	 AUXG18KV x2	 AUXG22KV x2	 AUXG24KV x2	 AUXG18KV x3
Duct	 ARXG18KL x2	 ARXG22KM x2	 ARXG24KM x2	 ARXG18KL x3
Outdoor unit	 AOYG36KBTB / AOYG36KRTA	 AOYG45KBTB / AOYG45KRTA	 AOYG54KBTB / AOYG54KRTA	

**Model: AOYG36KBTB / AOYG45KBTB / AOYG54KBTB  
AOYG36KRTA [3 phase] / AOYG45KRTA [3 phase] / AOYG54KRTA [3 phase]**



36

45/54

**Specifications (Indoor units/Outdoor units)**

Indoor Units Model No.				Compact Cassette		
				AUXG18KVLA	AUXG22KVLA	AUXG24KVLA
Power Source				Single phase, ~230V, 50Hz		
Airflow Rate	Cooling	H/M/L/Q	m <sup>3</sup> /h	680/580/490/410	830/740/600/450	930/830/600/450
	Heating	H/M/L/Q		800/680/580/450	860/760/700/530	930/850/700/530
Net Dimension H × W × D				mm		
Weight				kg(lbs)		
Cassette Grille				UTG-UFYF-W		

Indoor Units Model No.				Duct		
				ARXG18KLLAP	ARXG22KMLA	ARXG24KMLA
Power Source				Single phase, ~230V, 50Hz		
Airflow Rate	Cooling	H/M/L/Q	m <sup>3</sup> /h	940/880/820/750	1,100/910/750/580	1,100/910/750/580
	Heating	H/M/L/Q		940/880/820/750	1,100/910/750/580	1,100/910/750/580
Net Dimension H × W × D				mm		
Weight				kg(lbs)		

Outdoor Units Model No.			AOYG36KBTB	AOYG45KBTB	AOYG54KBTB	AOYG36KRTA	AOYG45KRTA	AOYG54KRTA
Capacity	Cooling	kW	9.5	12.1	13.4	9.5	12.1	13.4
	Heating		10.8	13.5	15.5	10.8	13.5	15.5
Power Source			Single phase, ~230V, 50Hz			3 phase, ~400V, 50Hz		
Pdesign	Cooling	kW	9.5	-	-	9.5	-	-
	Heating (-10°C)		8.7	-	-	8.7	-	-
SEER	Cooling	W/W	6.10	-	-	6.10	-	-
SCOP	Heating		4.00	-	-	4.00	-	-
Annual Energy Consumption	Cooling	kWh/a	545	-	-	545	-	-
	Heating		3,044	-	-	3,044	-	-
Energy Efficiency Class			Cooling	-	-	A++	-	-
Sound Pressure Level (High)	Cooling	dB(A)	A+	-	-	A+	-	-
	Heating		55	57	57	55	57	57
Sound Power Level (High)	Cooling	dB(A)	55	57	59	55	57	59
	Heating		70	71	73	70	71	73
Airflow Rate	Cooling / Heating	m <sup>3</sup> /h	3,750/3,750	4,450/4,450	4,450/4,450	3,750/3,750	4,450/4,450	4,450/4,450
Net Dimension H × W × D			mm			mm		
Weight			kg(lbs)			kg(lbs)		
Connection Pipe Diameter (Gas / Liquid)			Inch			Inch		
Max Pipe Length (Pre-Charge)			m			m		
Height Difference			m			m		
Operation Range	Cooling	°CDB	-15 to 46	-15 to 46	-15 to 46	-15 to 46	-15 to 46	-15 to 46
	Heating		-15 to 24	-15 to 24	-15 to 24	-15 to 24	-15 to 24	-15 to 24
Refrigerant	Type	kg	R32	R32	R32	R32	R32	R32
	Charge		1.90	2.70	2.70	1.90	2.70	2.70
Separation tube			UTP-SX236A(Twin)	UTP-SX236A(Twin)	UTP-SX236A(Twin) UTP-SX354A(Triple)	UTP-SX236A (Twin)	UTP-SX236A (Twin)	UTP-SX236A(Twin) UTP-SX354A(Triple)

- Different type and capacity indoor units cannot be connected.
- The above table is the value for connecting with cassette type.

**Dimensions**

(Unit : mm)

**AOYG36KBTB / AOYG36KRTA**

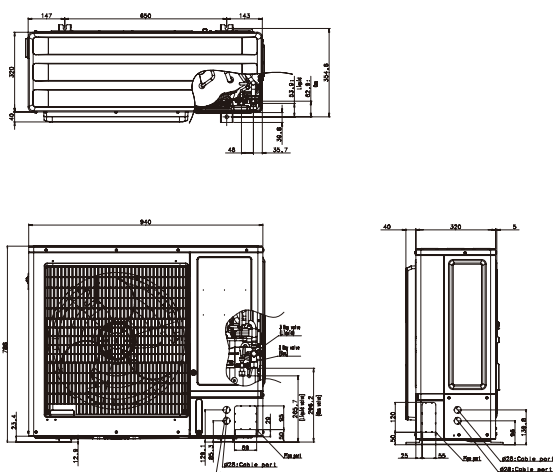

**AOYG45KBTB / AOYG54KBTB  
AOYG45KRTA / AOYG54KRTA**

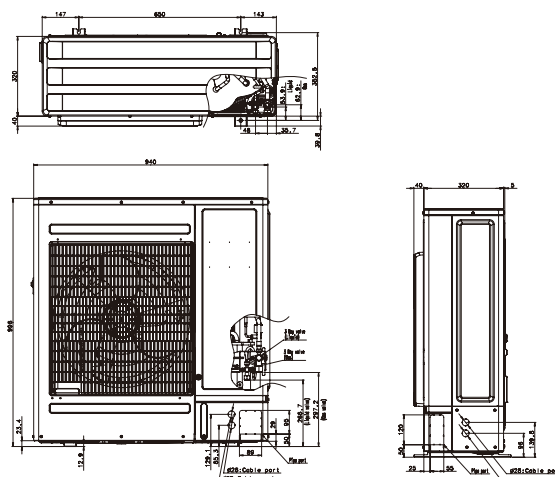

# Simultaneous Multi-split Twin/Triple/Quad



Can support various applications from large open plan offices to retail stores with up to 4 indoor units.

Indoor units distributed layout according to the shape and number of people and lighting conditions of the room. Ideal comfortable air flow distribution can be achieved.

Installation according to floor layout

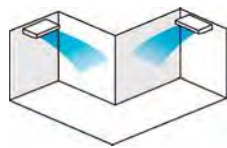

Installation according to lighting conditions

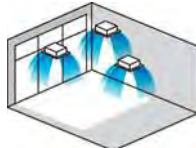

Installation according to layout and lighting conditions

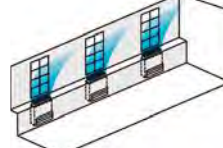

Installation according to large space

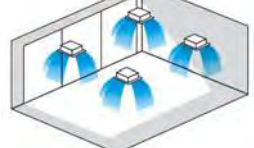

## Simultaneous control

Max 16 indoor units are simultaneously controlled with a wired remote controller.

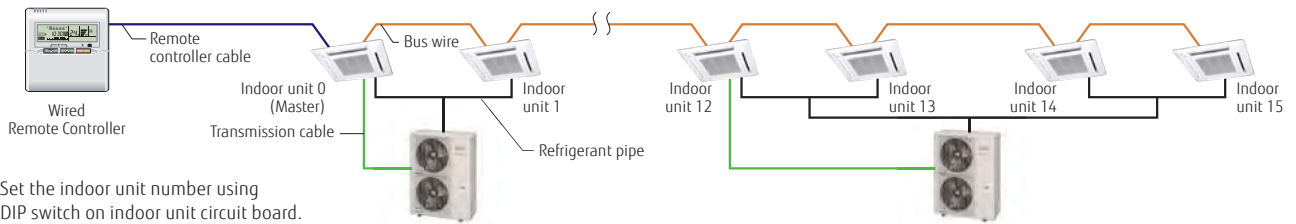

Set the indoor unit number using DIP switch on indoor unit circuit board.

\*When using a wireless remote controller, the following functions cannot be used: Timer operation, Sleep Timer operation, 10°C Heat operation

## Simultaneous Operation Multi type Indoor Unit Line up

	Twin		Triple		Quad
	36x2	45x2	24x3	30x3	18x4
Cassette	 AUYG36LR x2	 AUYG45LR x2	 AUYG24LV x3	 AUYG30LR x3	 AUYG18LV x4
Duct	 ARYG36LM x2	 ARYG45LM x2	 ARYG24LM x3	 ARYG30LM x3	 ARYG18LL x4
Ceiling	 ABYG36LR x2	 ABYG45LR x2	 ABYG24LV x3	 ABYG30LR x3	 ABYG18LV x4
Outdoor unit	 AOYG72LRLA	 AOYG90LRLA	 AOYG72LRLA	 AOYG90LRLA	 AOYG72LRLA

Model: AOYG72LRLA [3 phase] / AOYG90LRLA [3 phase]



**Specifications (Indoor units/Outdoor units)**

Indoor Units Model No.				Compact Cassette, Cassette				
				AOYG18LVLB	AOYG24LVLA	AOYG30LRLE	AOYG36LRLE	AOYG45LRLA
Power Source				Single phase, ~230V, 50Hz				
Airflow Rate	Cooling	H/M/L/Q	m <sup>3</sup> /h	750/610/520/410	930/830/600/450	1,600/1,400/1,270/1,150	1,800/1,400/1,270/1,150	1,900/1,640/1,460/1,250
	Heating	H/M/L/Q		800/710/600/450	930/830/600/450	1,800/1,400/1,270/1,150	1,800/1,400/1,270/1,150	1,900/1,640/1,460/1,250
Net Dimension H × W × D			mm	245×570×570	245×570×570	288 × 840 × 840	288 × 840 × 840	288 × 840 × 840
Weight			kg(lbs)	15 (33)	16 (35)	26 (57)	26 (57)	26 (57)
Cassette Grille				UTG-UFYD-W			UTG-UGYA-W	

Indoor Units Model No.				Duct				
				ARYG18LLTB	ARYG24LMLA	ARYG30LMLE	ARYG36LMLE	ARYG45LMLA
Power Source				Single phase, ~230V, 50Hz				
Airflow Rate	Cooling	H/M/L/Q	m <sup>3</sup> /h	940/880/820/750	1,100/910/750/580	1,900/1,620/1,270/980	1,900/1,620/1,270/980	2,100/1,750/1,350/1,070
	Heating	H/M/L/Q		940/880/820/750	1,100/910/750/580	2,100/1,620/1,270/980	2,100/1,620/1,270/980	2,100/1,750/1,350/1,070
Net Dimension H × W × D			mm	198 × 900 × 620	270 × 1135 × 700	270 × 1135 × 700	270 × 1135 × 700	270 × 1135 × 700
Weight			kg(lbs)	23 (51)	38 (84)	40 (88)	40 (88)	40 (88)

Indoor Units Model No.				Floor/Ceiling, Ceiling				
				ABYG18LVTB	ABYG24LVTA	ABYG30LRTE	ABYG36LRTE	ABYG45LRTA
Power Source				Single phase, ~230V, 50Hz				
Airflow Rate	Cooling	H/M/L/Q	m <sup>3</sup> /h	780/700/560/500	980/820/680/540	1,660/1,500/1,200/1,000	1,900/1,500/1,200/1,000	2,100/1,700/1,400/1,100
	Heating	H/M/L/Q		780/700/560/500	980/820/680/540	1,660/1,500/1,200/1,000	1,900/1,500/1,200/1,000	2,100/1,700/1,400/1,100
Net Dimension H × W × D			mm	199 × 990 × 655	199 × 990 × 655	240 × 1660 × 700	240 × 1660 × 700	240 × 1660 × 700
Weight			kg(lbs)	27 (60)	27 (60)	46 (101)	46 (101)	46 (101)

Outdoor Units Model No.			AOYG72LRLA		AOYG90LRLA	
Capacity	Cooling	kW	19.0		22.0	
	Heating		22.4		27.0	
Power Source			3 phase, ~400V, 50Hz			
Sound Pressure Level (High)	Cooling/Heating	dB(A)	55/55		55/57	
Airflow Rate	Cooling / Heating	m <sup>3</sup> /h	8,400/8,400		8,400/9,000	
Net Dimension H × W × D		mm	1,428×1,080×480		1,428×1,080×480	
Weight		kg(lbs)	163 (359)		172 (379)	
Connection Pipe Diameter (Gas / Liquid)		Inch	7/8 & 1/2		1 & 1/2	
Max Pipe Length (Pre-Charge)			100 (30)		100 (30)	
Height Difference		m	30		30	
Operation Range	Cooling	°CDB	-15 to 46		-15 to 46	
	Heating		-20 to 24		-20 to 24	
Refrigerant	Type		R410A		R410A	
	Charge	kg	5.6		7.1	
Separation tube			UTP-SX272A×1 (Twin)	UTP-SX272A×1 UTP-236A×2 (Double Twin)	UTP-SX272A×1 (Twin)	UTP-SX372A×1 (Triple) UTP-SX254A×2 (Double Twin)

\*: That specification is not fixed yet.







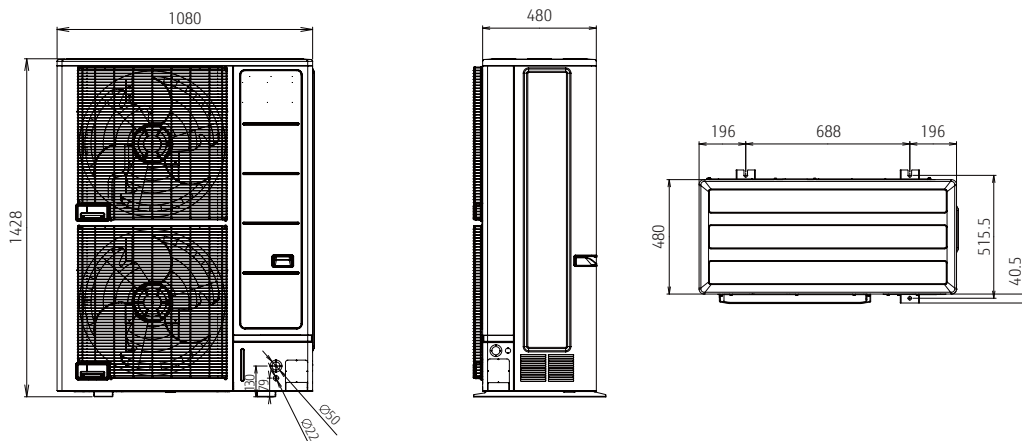

































- Different type and capacity indoor units cannot be connected.
- The above table is the value for connecting with cassette type.

**Dimensions**

(Unit : mm)



# Feature Explanation & Summary

Type		Wall Mounted				
Series		Designer Series		Standard Series	Designer Series	Standard Series
Model No.						
Refrigerant						
Energy Saving Function	 Save human sensor	Human sensor detects the movement of people in the room and judges whether the energy saving operation.		<input checked="" type="checkbox"/>		
	 Economy mode	Thermostat setting automatically changes according to the temperature to avoid unnecessary cooling and heating.		<input checked="" type="checkbox"/>	<input checked="" type="checkbox"/>	<input checked="" type="checkbox"/>
	 Room temperature set point limitation	The minimum and maximum temperature range can be set giving further energy saving while considering the comfort of the occupants.		<input type="checkbox"/>	<input type="checkbox"/>	<input type="checkbox"/>
	 Set temperature auto return	The setting temperature automatically returns to the previously set temperature.		<input type="checkbox"/>	<input type="checkbox"/>	<input type="checkbox"/>
Comfortable Function	 Power diffuser	An additional louvre that opens based on monitoring sensors to quickly enhance immediate comfort needs				<input checked="" type="checkbox"/>
	 Powerful mode	Operation at maximum air flow and compressor speed, and quickly makes the room comfortable.		<input checked="" type="checkbox"/>	<input checked="" type="checkbox"/>	<input checked="" type="checkbox"/>
	 10°C HEAT operation	The room temperature can be set to go no lower than 10°C, thus ensuring that the room does not get too cold when not occupied.		<input checked="" type="checkbox"/>	<input checked="" type="checkbox"/>	<input checked="" type="checkbox"/>
	 Low noise mode	Sound noise level of outdoor unit can be selected.		<input checked="" type="checkbox"/>	<input checked="" type="checkbox"/>	<input checked="" type="checkbox"/>
	 Auto-changeover	The unit automatically switches between heating and cooling modes based on your temperature setting and the room temperature.		<input checked="" type="checkbox"/>	<input checked="" type="checkbox"/>	<input checked="" type="checkbox"/>
	 Up/down swing flaps	The up/down flaps automatically swing up and down.		<input checked="" type="checkbox"/>	<input checked="" type="checkbox"/>	<input checked="" type="checkbox"/>
	 Double swing automatic	Complex swing action of flaps enables automatically to swing both horizontal and vertical directions.				
	 Automatic fan speed	The micro-computer automatically adjusts the airflow effectively to follow the changes of room temperature.		<input checked="" type="checkbox"/>	<input checked="" type="checkbox"/>	<input checked="" type="checkbox"/>
	 Auto restart	In the event of a temporary power failure, the air conditioner will automatically restart in the same operating mode as before, once power supply is restored.		<input checked="" type="checkbox"/>	<input checked="" type="checkbox"/>	<input checked="" type="checkbox"/>
	 Connectable fresh air duct	Outside air can be introduced by attaching Locally purchased duct to fresh air knockout and optional part.				
	 Fresh air intake	Fresh air can be taken in by a fan which can be connected using external control unit.				
	 Connectable distributing duct	Systems are capable of attaching Locally purchased branch ducts distributing the airflow.				
	Convenient Function	 Auto off timer	Automatically stops operation when a fixed time has elapsed from the start of operation.		<input type="checkbox"/>	<input type="checkbox"/>
 Sleep timer		The micro-computer gradually changes the room temperature automatically to afford a comfortable night's sleep.		<input checked="" type="checkbox"/>	<input checked="" type="checkbox"/>	<input checked="" type="checkbox"/>
 Program timer		This digital timer allows selection of one of four options: ON, OFF, ON + OFF or OFF + ON.		<input checked="" type="checkbox"/>	<input checked="" type="checkbox"/>	<input checked="" type="checkbox"/>
 Weekly timer		Different ON-OFF times can be set for each day.		<input checked="" type="checkbox"/>	<input checked="" type="checkbox"/>	<input type="checkbox"/>
 Weekly + setback timer		Weekly + Setback timer can set temperature for two times spans and for each day of the week.		<input type="checkbox"/>	<input type="checkbox"/>	<input type="checkbox"/>
 Filter sign		Indicates the filter cleaning period by lamp.		<input checked="" type="checkbox"/>	<input checked="" type="checkbox"/>	<input checked="" type="checkbox"/>
 External error output				<input type="checkbox"/>	<input type="checkbox"/>	<input type="checkbox"/>
 External ON/OFF input				<input type="checkbox"/>	<input type="checkbox"/>	<input type="checkbox"/>
Clean Function	 Wireless LAN control	The exclusive Wireless LAN adaptor enables to operate the air conditioner by smartphone or tablet PC from outside.		<input type="checkbox"/>	<input type="checkbox"/>	<input type="checkbox"/>
	 Ion deodorisation filter	The filter deodorises by powerfully decomposing absorbed odors using the oxidizing and reducing effects of ions generated by the ultra-fine-particle ceramic.		<input type="checkbox"/>	<input type="checkbox"/>	<input checked="" type="checkbox"/>
	 Apple-catechin filter	The Apple-catechin filter uses static electricity to clean fine particles and dust in the air.		<input type="checkbox"/>	<input type="checkbox"/>	<input checked="" type="checkbox"/>
	 Long life filter					
Installation	 Washable panel	Since the front panel is easy to remove, maintenance is also easy.				<input checked="" type="checkbox"/>
	 Drain pump as standard					
	 Blue fin					

Wall Mounted			Cassette			Duct						Floor	Floor/Ceiling	Ceiling
Standard Series		Compact 4-way Flow Grid type Series	Compact 4-way Flow Series	4-way Flow Series	Mini (With drain pump)		Slim (With drain pump)		Medium Static Pressure					
R410A		R32	R410A		R32	R410A		R32	R410A	R32	R410A	R410A		
●	●	●	●	●	●	●	●	●	●	●	●	●	●	●
○	○	○	○	○	○	●	●	○	○	○	○	○	○	○
○	○	●	○	○	●	●	○	○	○	○	○	○	○	○
●														
	●													
	●	●	●	●	○	○	○	○	○	○	○	●	●	●
		●									○ (45/36LMLA)			○ (45/54) (36LRTA)
	●	●	●	●	●	●	●	●	●	●	●	●	●	●
	●	●	●	●	●	●	●	●	●	●	●	●	●	●
	●											●	●	
	●	●	●	●	●	●	●	●	●	●	●	●	●	●
	●	●	●	●	●	●	●	●	●	●	●	●	●	●
			○	○						●	●			
			○	○				○	○	○	○			○
										●	●			
	○	○	○	○	○	●	●	○	○	○	○	○	○	○
	●	●	●	●	○	○	○	○	○	○	○	●	●	●
	●	●	●	●	○	○	○	○	○	○	○	○	○	○
	○	○	○	○	○	○	○							
	○	○	○	○	○	○	○	○	○	○	○	○	○	○
	○	○	○	○	○	○	○	○	○	○	○	○	○	○
	○	○	○	○	○	○	○	○	○	○	○	○	○	○
	○	○	○	○	○	○	○	○	○	○	○	○	○	○
	○	○	○	○	○	○	○	○	○	○	○	○	○	○
	○	○	○	○	○	○	○	○	○	○	○	○	○	○
	○	○	○	○	○	○	○	○	○	○	○	○	○	○
●	○											●		
●	○											●		
										○	○			
	●											●		
	○		●	●	●	●	●	●	○	○				○
● (30)				● (45/54)							● (45)			● (45)

# Control System Overview

For Split & Multi-split

We have wireless or wired remote controllers as standard equipment. Other options, such as individual and central remote controllers, are also available. The easy-to-operate central remote controller makes it simple to control the operation mode, temperature, airflow volume, timer, and other functions of each indoor unit from a single location.

## Air Conditioning Individual Control

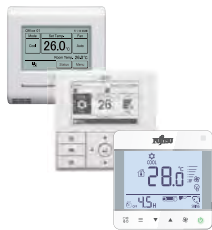

### Wired Remote Controller

The room temperature can be controlled by detecting the temperature accurately from the built-in sensor

NEW



### Wireless Remote Controller

Simple and sophisticated operations with a choice of 4 daily timers



### Simple Remote Controller

Compact remote controller provides access to basic functions

NEW

For Ceiling type

For Duct type



IR Receiver Unit

Wireless Remote Controller

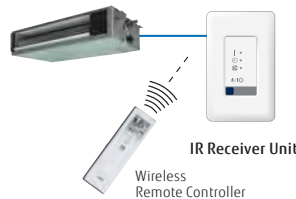

IR Receiver Unit

Wireless Remote Controller

For Cassette type



### IR Receiver Unit

Necessary to control for all duct type by Wireless Remote Controller



## Air Conditioning Centralised Control



### Central Remote Controller For 5-6 Rooms Multi

Central Remote Controller allows individual and central control





## Converter/Adaptor

For external control via BMS/Home Automation Systems

### MODBUS® Converter

For indoor unit  
UTY-VMSX



### MODBUS® Interface

For indoor unit  
FJ-RC-MBS-1



### KNX® Converter

For indoor unit  
UTY-VKSX



### KNX® Interface

For indoor unit  
FJ-RC-KNX-1i



### Wireless LAN Interface

FJ-RC-WIFI-2  
FJ-AC-WIFI-1



### Network Converter

(DC power supply)  
UTY-VTGX



(AC power supply)  
UTY-VTGXV

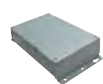

## Online Control (Wireless Control via Smart Phone/Tablet)

By using our Wireless LAN Interface and FGLair app, you can control your home's cooling and heating anytime and anywhere.

### Wireless LAN Interface

The exclusive Wireless LAN adaptor enables to operate the air conditioner by smartphone or tablet PC from outside.



### NEW Simple design and user friendly interface

The new design more user friendly screen display allows you to operate easier than ever before.

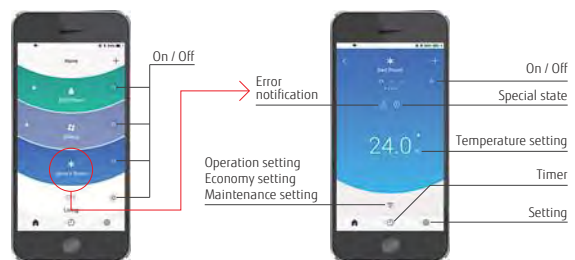

# Controller System List (available) For Split/Multi-split

Controller Options / Accessories:



Type		Indoor unit						
		Wall Mounted						
		Designer Series		Standard Series			Economy Series	
		ASYG 07/09/12/14 KGTB	ASYG 07/09/12/14 KETA	ASYG 07/09/12/14 KMCC	ASYG 18/24KMTA	ASYG 30/36KMTA	ASYG 07/09/12 KPCA	
Controllers	Wired Remote Controller		● UTY-RNRYZ3+ UTY-TWRXZ2			● UTY-RNRYZ3+ UTY-TWRXZ2		
			● UTY-RLRY+ UTY-TWRXZ2			● UTY-RLRY+ UTY-TWRXZ2		
			● UTY-RCRYZ1+ UTY-TWRXZ2			● UTY-RCRYZ1+ UTY-TWRXZ2		
					● UTY-RVNYM+ UTY-TWBXF2			
	Simple Remote Controller		● UTY-RSRY, UTY-RHRY+ UTY-TWRXZ2		● UTY-RSNYM+ UTY-TWBXF2	● UTY-RSRY, UTY-RHRY+ UTY-TWRXZ2		
	Central Remote Controller							
	Wireless Remote Controller							
IR Receiver Unit with Wireless Remote Controller								
Interface	MODBUS Convertor		● UTY-VMSX	● UTY-VMSX*1	● UTY-VMSX	● UTY-VMSX*1		
	MODBUS Interface							
	KNX Convertor		● UTY-VKSX	● UTY-VKSX*1	● UTY-VKSX	● UTY-VKSX*1		
	KNX Interface							
	Wireless LAN Interface		● UTY-TFSXW1		● UTY-TFSXW1			
				● UTY-TFSXF2		● UTY-TFSXF2		
					● FJ-AC-WIFI-1			
External Switch Controller		● UTY-TERX+UTY-TWRXZ2		● UTY-TERX+ UTY-TWBXF2	● UTY-TERX+UTY-TWRXZ2			
Network Converter for Single Split		● UTY-VTGX+UTY-TWRXZ2 or UTY-VTOXV+UTY-TWRXZ2		● UTY-VTGX+UTY-TWBXF2 or UTY-VTOXV+UTY-TWBXF2	● UTY-VTGX+UTY-TWRXZ2 or UTY-VTOXV+UTY-TWRXZ2			



Indoor unit									
Cassette		Cassette				Ceiling	Multi-split		
Compact 4-way Flow Series	Circular Flow Series	Slim	Medium Static Pressure (Compact & Comfort)	Medium Static Pressure (Standard)	High Static Pressure		Compact Cassette	Mini Duct	Slim Duct
AUXG 09/12/14/18/22/24 KVLA	AUXG 18/22/24/30/36/45/54 KRLB	ARXG 09/12/14/18 KLLAP	ARXG 12/14/18/22/24/30/36/45/54 KHTAP	ARXG 22/24/30/36/45 KMLA	ARXG 45/54KHTA	ABYG 18/22/24/30/36/45/54 KRTA	AUXG 07KVLA	ARXG 07/09/12/14 KSLAP	ARXG 07KLLAP
		● UTY-RNRYZ3					● UTY-RNRYZ3		
		● UTY-RLRY					● UTY-RLRY		
		● UTY-RCRYZ1					● UTY-RCRYZ1		
		● UTY-RVNYM					● UTY-RVNYM		
		● UTY-RSRY, UTY-RHRY, UTY-RSNYM				● UTY-RSNYM	● UTY-RSRY, UTY-RHRY	● UTY-RSRY, UTY-RHRY, UTY-RSNYM	
● UTY-LNTY							● UTY-LNTY		
	● UTY-LBTYC	● UTY-LBTYM				● UTY-LBTYH	● UTY-LBTYM	● UTY-LBTYM	
		● UTY-VMSX					● UTY-VMSX		
		● FJ-RC-MBS-1						● FJ-RC-MBS-1	
		● UTY-VKSX					● UTY-VKSX		
		● FJ-RC-KNX-1i					● FJ-RC-KNX-1i		
		● UTY-TFSXZ1				● UTY-TFNXZ1	● UTY-TFSXZ1		
		● FJ-RC-WIFI-2					● FJ-RC-WIFI-2		
		● FJ-AC-WIFI-1					● FJ-AC-WIFI-1		
		● UTY-TERX							
		● UTY-VTGX UTY-VTGXV							

\*There are no optional parts for KL series.  
\*1: It can be used only when the wireless LAN interface (UTY-TFSXF2) is removed.

# Controller System List (available) For Split/Multi-split

Controller Options / Accessories:



Type	Indoor unit								Outdoor unit	Other	
	Duct		Floor	Floor/Ceiling	Multi-split			Single Phase	Branch Box (8 Rooms Multi)		
	High Static Pressure	Big			Compact Cassette	Mini Duct	Slim Duct			Floor Ceiling	
	ARYG 45/54/60 LHTA	ARYG 72/90LHTA	AGYG 09/12/14 LVCA	ABYG 18/LV1B, ABYG 24/LVTA	AUYG 07/09/LVLA	ARYG 07/09/LSLAP	ARYG 07/09/LLTA	ABYG 14/LVTA	AOYG 36/LBLA5, AOYG 45/LBLA6	UTP-PY03A UTP-PY02A	
Controllers	Wired Remote Controller		● UTY-RNRYZ3				● UTY-RNRYZ3				
			● UTY-RLRY				● UTY-RLRY				
			● UTY-RCRYZ1				● UTY-RCRYZ1				
			● UTY-RVNYM								
			● UTY-RNNYM								
Simple Remote Controller	2-wire type	● UTY-RSNYM	● UTY-RSPRY, UTY-RHRY, UTY-RSNYM	● UTY-RSNYM		● UTY-RSPRY, UTY-RHRY, UTY-RSNYM	● UTY-RSNYM				
Central Remote Controller									● UTY-DMMYM		
Wireless Remote Controller					● UTY-LNTY						
IR Receiver Unit with Wireless Remote Controller	For Duct	● UTY-LRHYM (60)	● UTY-LRHYM				● UTY-LRHYM				
	For Cassette		● UTY-LBTYM			● UTY-LBTYM					
Interface	MODBUS Convertor		● UTY-VMSX				● UTY-VMSX				
	MODBUS Interface		● FJ-RC-MBS-1								
	KNX Convertor		● UTY-VKSX				● UTY-VKSX				
	KNX Interface		● FJ-RC-KNX-1i								
	Wireless LAN Interface		● UTY-TFSXZ1		● UTY-TFNXZ1		● UTY-TFSXZ1	● UTY-TFNXZ1	● UTY-TFNXZ1		

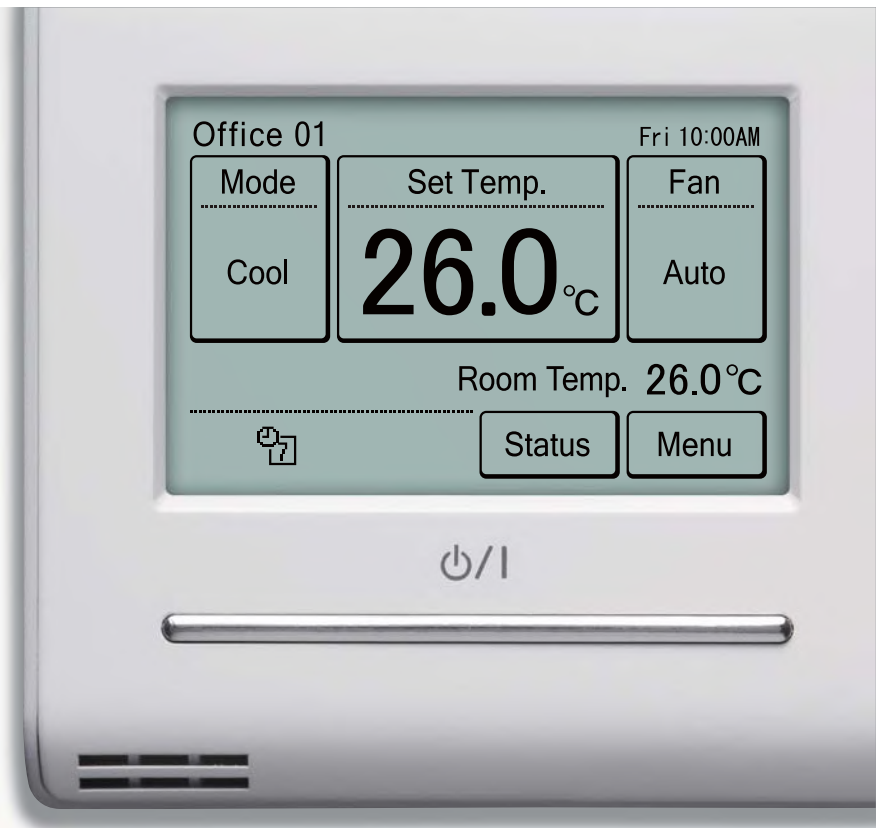

# Optional Parts Overview

For Split & Multi-split

Various optional parts are provided to install the selected indoor unit properly according to the environment.

## Optional Parts For Cassette



### Human Sensor Kit

The room temperature can be controlled by detecting the temperature accurately from the built-in sensor

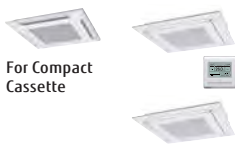

For Compact Cassette

### Cassette Grille

Cassette grille lineup including grid ceiling type cassette grille is also added to the lineup.



For Compact Cassette

For Cassette

### Fresh Air Intake Kit

Fresh air can be taken in by a fan which can be connected using external control unit.



Linwood now offer an extensive range of plenum boxes to suit the Fujitsu General Air Conditioning UK range of ducted air conditioning indoor units

Installing air conditioning ducted fan coil units (FCU's) just got easier with these purpose made plenum boxes designed to save you time and money when fitting VRF or split air conditioning systems



Easy to use online ordering & live order processing via [www.airconplenums.com/fujitsu-plenum](http://www.airconplenums.com/fujitsu-plenum)

*filter not supplied with plenum*



## Optional Parts For Duct & Ceiling



**Auto Louvre Grille Kit**  
Simple flat Auto louvre will provide comfort airflow and harmonise with luxury Interior.



**Remote Sensor Unit**  
New amenity space can be offered by installing the Remote sensor.



**Long Life Filter**  
Grit and dust can be caught sufficiently. In consideration of running cost, long-life design is achieved.

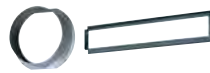

**Flange**  
Flange is used for Medium Static Pressure Duct type and Ceiling type to connect between pipes.



**Drain Pump Unit**  
This device can drain the collected water during operation.

## Connection Parts



For Wall Mounted type

**Communication Kit**  
For wall mounted type, this kit is required when External Connect kit & Set or wired remote controller is connected to indoor unit.



For Wall Mounted type

**External Input and Output PCB**  
For Wall mounted, Duct, or Cassette type, these parts are required when external input and output function is used.



For Duct and Cassette type



**External Input and Output PCB Box & Bracket**  
These are the box and bracket for installing the External input and output PCB

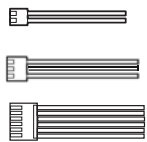









**External Connect Kit & Set**  
These wires can connect between the product PCB and external device.

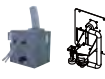

**Connection Units**  
Connection units are provided to separate the pipes at the connection of multiple indoor units in multi-split type or VRF system.

# Optional Parts List For Split/Multi-split

Type	Refrigerant	Indoor unit								
		Cassette			Duct					
		4-way Flow Compact	Circular Flow	4-way Flow	Mini	Slim		Medium Static Pressure (Compact & Comfort)	Medium Static Pressure (Standard)	High Static Pressure
	R32	AUXG 09/12/14/ 18/22/24 KVLVA	AUXG 18/22/24/ 30/36/45/54 KRLB			ARXG 09/12/14/18 KLLAP		ARXG 12/14/18/22/ 24/30/36/45/54 KHTAP	ARXG 22/24/30/36/45 KMLA	ARXG45/54KHHTA
	R410A	AUYG 12/14/18 LVLB, AUYG24LVLVA	AUXG 18/24/30/ 36/45/54 LRLB	AUYG30/36LRLE, AUYG 36/45/54 LRLA	ARYG12/14/18LSLAP		ARYG12/14/18LLTB	ARYG 12/14/18/24/ 30/36/45/54 LHTBP	ARYG 24/36/45 LMLA, ARYG30/36LMLE	ARYG45/54/60LHTA
Human Sensor Kit			● UTY-SHZXC							
Remote Sensor Unit	 New amenity space can be offered by installing the Remote sensor.							● UTY-XSZX		
Cassette Grille		● UTG-UFYF-W (KVLVA), UTG-UFYD-W (LVLVA,LVLB)	● UTG-UKYA-W, UTG-UKYC-W,	● UTG-UGYA-W						
Auto Louvre Grille Kit					● UTD-GXSA-W (09/12/14) UTD-GXSB-W (18)	● UTD-GXSA-W (12/14) UTD-GXSB-W (18) UTD-GXSA-W (12/14) UTD-GXSB-W (18)				
Long Life Filter							● UTD-LFNA (36/45/54) UTD-LFNB (18/22/24/30) UTD-LFNC (12/14)	● UTD-LF25NA	● UTD-LF60KA (45/54)	
Flange								● UTD-SF045T UTD-RF204		
Drain Pump Unit								● UTZ-PX1NBA		
Fresh Air Intake Kit	 For Compact Cassette For Cassette	● UTZ-VXAA	● UTZ-VXRA	● UTZ-VXGA						
Remote Controller Holder										





Indoor unit										
Duct	Multi-split									
Big	Floor	Ceiling		Wall Mounted		Wall Mounted	4-way flow Compact Cassette	Mini Duct	Slim Duct	Floor Ceiling
		ABYG 18/22/24/30/ 36/45/54 KRTA		ASYG 07/09/12 KPCA			AUYG07KVLA	ARYG 07/09/12 KSLAP	ARYG07KLLAP	
ARYG72/90LHTA	AGYG 09/12/14 LVCA		ABYG30/36LRTE, ABYG 36/45/54 LRTA		ASYG 07/09/12 LLCE	ASYG14KMCC	AUYG07/09LVLA	ARYG07/09LSLAP	ARYG07/09LLTA	ABYG14LVTA
● UTY-XSZX									● UTY-XSZX	
							● UTG-UFYF-W (KVLA), UTG-UFYD-W (LVLA)			
									● UTD-GXTA-W (07/09/12)	
● UTD-LFKA										
			● UTD-RF204							
● UTZ-PX1NAB			● UTR-DPB24T							
							● UTZ-VXAA			
				● UTZ-RXLA						

# External Input and Output Table

External Control	Input			Output			
	Start / Stop	Peak Cut	Low Noise	Op Status	Error Status	Fresh Air	Aux Heater
<b>WALL MOUNT</b>							
Compact							
ASYG07-14KGT*6	2			2	2		
ASYG07-14KMTA*5	2			2	2		
ASYG09-12LTCA*1	2			2	2		
ASYG07-14LUCA*1	2			2	2		
ASYG07-14LMCE*2	2			2	2		
Large							
ASYG18LFCA	1			1/7*A	7*A		
ASYG24LFCC	1			1/7*A	7*A		
ASYG30-36LMTA*3	1			1	1		
<b>DUCT</b>							
Slim							
ARYG07-14LLTA	3			3/7	7	3	3
ARYG12-18LLTB	3			3/7	7	3	3
Bulkhead							
ARYG12-18SLAP	PCB Terminal			6	6		6
Medium Static							
ARYG12-54LHTBP*4	6			6	6		6
ARYG24-45LMLA	3			3/7	7	3	
ARYG30-36LMLE	3			3/7	7	3	
High Static							
ARYG45-60LHTA	3			3/7	7	3	3
ARYG72-90LHTA	PCB Terminal			6	6		6
<b>CASSETTE</b>							
Compact							
AUYG07-09LVLA	1			1/7	7	3/*B	
AUYG12-18LVLB	1			1/7	7	3/*B	
AUYG24LVLA	1			1/7	7	3/*B	
Circular Flow							
AUXG18-54LRLB*4	6			6	6		6
4 Way Flow							
AUYG30-36LRLE	1			1/7	7	3/*C	
<b>FLOOR</b>							
AGYG09-14LVCA	1			1/7	7		
<b>FLOOR/CEILING</b>							
ABYG14LVTA	1			1/7	7		
ABYG18LVTB	1			1/7	7		
ABYG24LVTA	1			1/7	7		
<b>CEILING</b>							
ABYG30-36LRTE	1			1/7	7	3	
ABYG36-54LRTA	1			1/7	7	3	
<b>SINGLE PHASE OUTDOOR</b>							
Split							
AOYG45-54LETL		5	5	5	5		
Multi							
AOYG36-54LBTB		5	5	5	5		
<b>3 PHASE OUTDOOR</b>							
Split							
AOYG36-60LATT		4	4	4	4		
AOYG72-90LRLA		5	5	5	5		
Multi							
AOYG36-54LATT		4	4	4	4		
AOYG72-90LRLA		5	5	5	5		

\*1 UTY-TWBXF Communication Kit required

\*2 UTY-XCBXZ2 Communication Kit required

\*3 UTY-XCSXZ1 Required for more than 1 input or output

\*4 UTY-XCSX Required for more than 1 input or output

\*5 UTY-TWBX2 Communication Kit required







\*6 UTY-XCSXZ2 Communication Kit required

\*A Part 9705932012 required

\*B Cable included with UTZ-VXAA

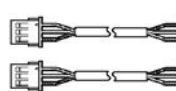
\*C Cable included with UTZ-VXGA

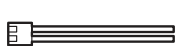
## Communication system For SPLIT/MULTI SPLIT

<b>External Connect Kit</b> For Indoor Unit 1=UTYXWZX 		<b>External Control Set</b> For Indoor Unit 2=UTYXWZXZ5 		<b>External Connect Kit</b> For Indoor Unit 3=UTDECSSA 		<b>External Connect Kit</b> For Outdoor unit 4=UTYXWZXZ2 		<b>External Connect Kit</b> For Outdoor unit 5=UTYXWZXZ3 	
<b>External Connect Kit</b> For Indoor unit 6=UTYXWZXZG 		<b>Error Output Adaptor</b> 7=UTIERRW  <p>9705932012 For use with all AS and AG models when using Intesis range and Network converter BMS options</p>		<b>Wired Remote Connector</b> 9705932012  <p>For use with all AS and AG models when using Intesis range, Network converter, BMS options and Wired remotes.</p>					

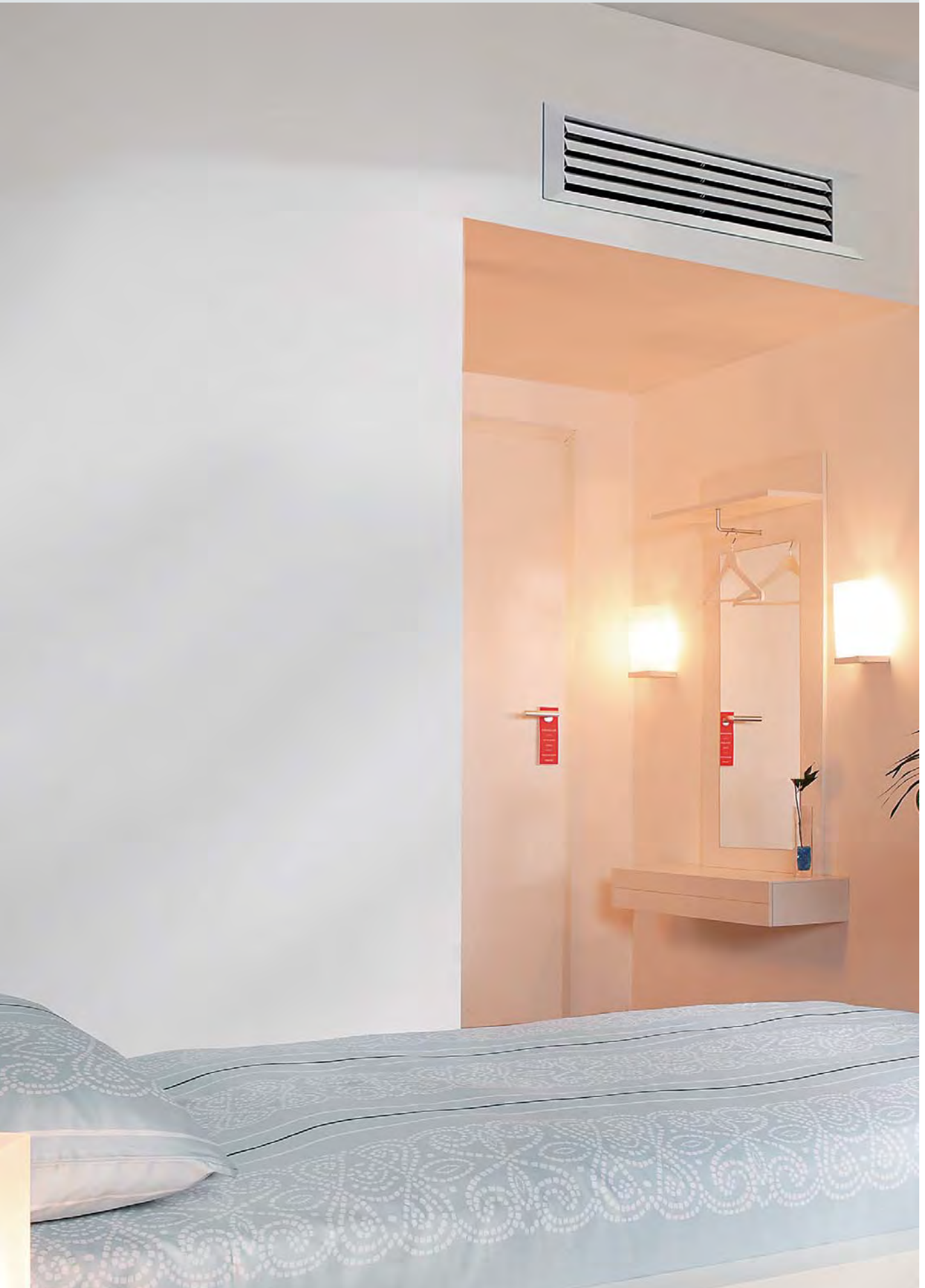

## Light Commercial & Commercial, Residential

# VRF

AIRSTAGE™ VRF systems can be designed to create an air conditioning solution to suit most buildings requirements.

AIRSTAGE™ VRF systems can be designed to effectively provide an air conditioning solution from a large domestic residence through to a large scale commercial building.

- 138 VRF Outdoor Units Lineup
- 142 AIRSTAGE™ J Series Overview
- 154 AIRSTAGE™ V Series Overview

### VRF Outdoor Units



#### AIRSTAGE™ J Series Heat Pump for Small Capacity Type

- 144 AIRSTAGE™ J-IVS
- 146 AIRSTAGE™ J-III
- 148 AIRSTAGE™ J-IV
- 150 AIRSTAGE™ J-IIIIL
- 152 AIRSTAGE™ J-IVL



#### AIRSTAGE™ V Series Heat Recovery Modular Type

- 156 AIRSTAGE™ VR-II
- 160 AIRSTAGE™ VR-IV

#### Heat Pump Modular Type

- 164 AIRSTAGE™ V-III

### VRF INDOOR UNITS

- 168 VRF Indoor Units Lineup
- 170 VRF Indoor Units

- 184 Control System Overview



# AIRSTAGE™

## VRF

Light Commercial &  
Commercial,  
Residential



FUJITSU GENERAL (Euro) GmbH participates in the ECP programme for VARIABLE REFRIGERANT FLOW SYSTEMS. Check ongoing validity of certificate: [www.eurovent-certification.com](http://www.eurovent-certification.com)  
\* Models so marked are not ECC certified.

**FUJITSU GENERAL LIMITED**



# Small Offices

For Light Commercial

Fujitsu General provides perfect ideal air conditioning systems that take into account energy saving, low noise, comfortable airflow, small room application and centralised control for small-sized office buildings with many small rooms.

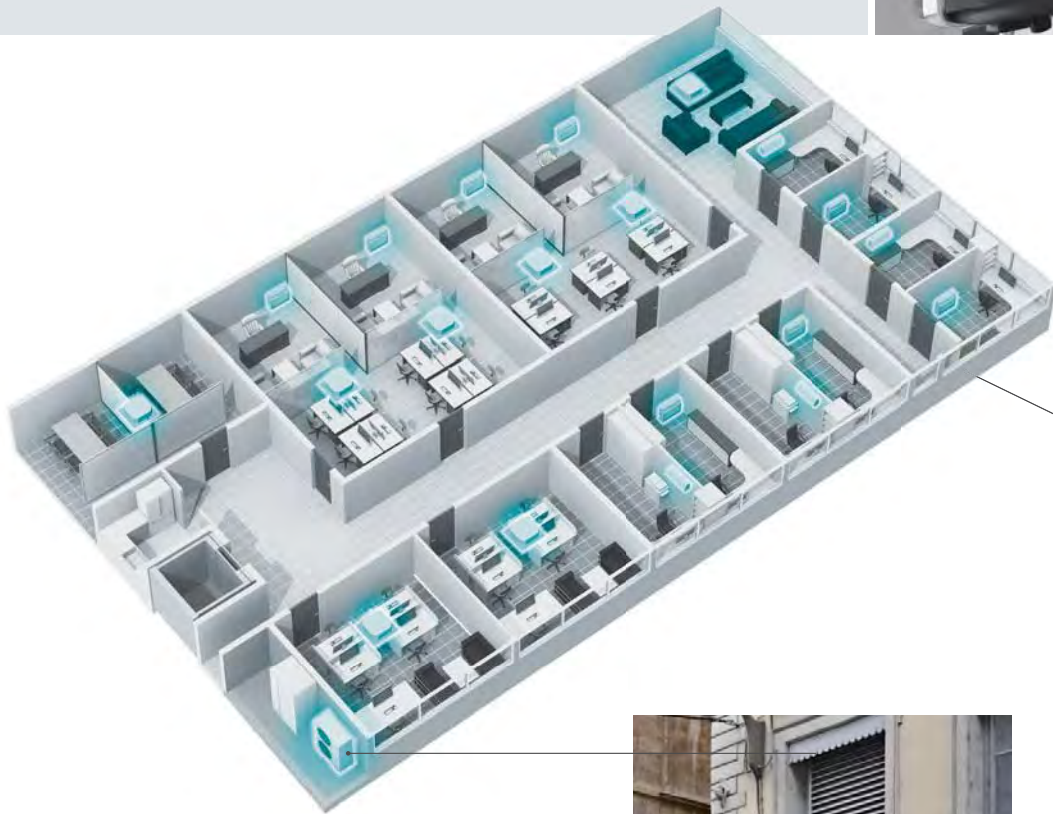

NEW

## AIRSTAGE™ J Series Up to 18 HP with a compact outdoor unit

This small VRF system is suitable for a building with many small rooms. Max. 42\* indoor units can be connected.

\*Only J-IVL 18 HP model

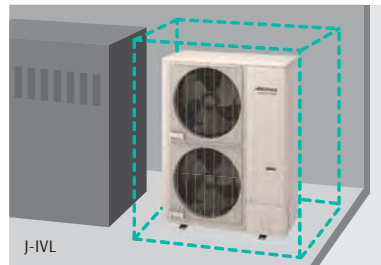

### Compact and low noise outdoor unit

This compact outdoor unit does not take up much space even if installed in a machine room or on the rooftop. This unit provides enough static pressure even if there are louvres. Low noise operation is possible at nighttime by a low noise mode.



Central Remote Controller UTY-DCGYZ1



### Centralised remote controller with improved operability

Each individual room can have its own schedule setting. This controller makes energy saving management possible with upper/lower temperature limit settings and operation prohibited settings.

### Various indoor units lineup for low capacity class

Various range of low capacity 1.1 kW indoor units to suit small rooms or spaces.



LAN



PC

### Control and monitoring

The same level of management that is possible from the centralised controller is possible even if you are at your desk. Non-administrators can also operate the air conditioners with a PC, Smartphone or tablet.



Wireless LAN

Router

Fixed IP, IP forwarding and open Port required



Tablet PC

Smartphone

\*Wireless LAN support : Future release



NEW

### New Compact wired remote controller

A compact controller with a large screen making operation easy. A stylish design to suit any interior..



# Large Building

For Commercial

Fujitsu General provides modular type VRF systems that seek high efficiency, comfort, design freedom, easy installation and reliability for large commercial buildings.



## Abundant lineup suitable to match the operating environment

VRF Series lineup to meet various needs such as energy saving-orientated models.



NEW

### AIRSTAGE™ VR-IV

Cutting-edge design. Extensive lineup from 8 HP to 48 HP in 2 HP increment. Connectable indoor unit capacity ratio up to 150%

#### 8 HP - 48 HP 34 Models

- Space saving combination: 8 HP to 48 HP/21 models
- Energy efficiency combination: 16 HP to 44 HP/13 models

### AIRSTAGE™ V-III

#### 8 HP - 54 HP 39 Models

- Space saving combination: 8 HP to 54 HP/24 models
- Energy efficiency combination: 16 HP to 46 HP/ 15 models

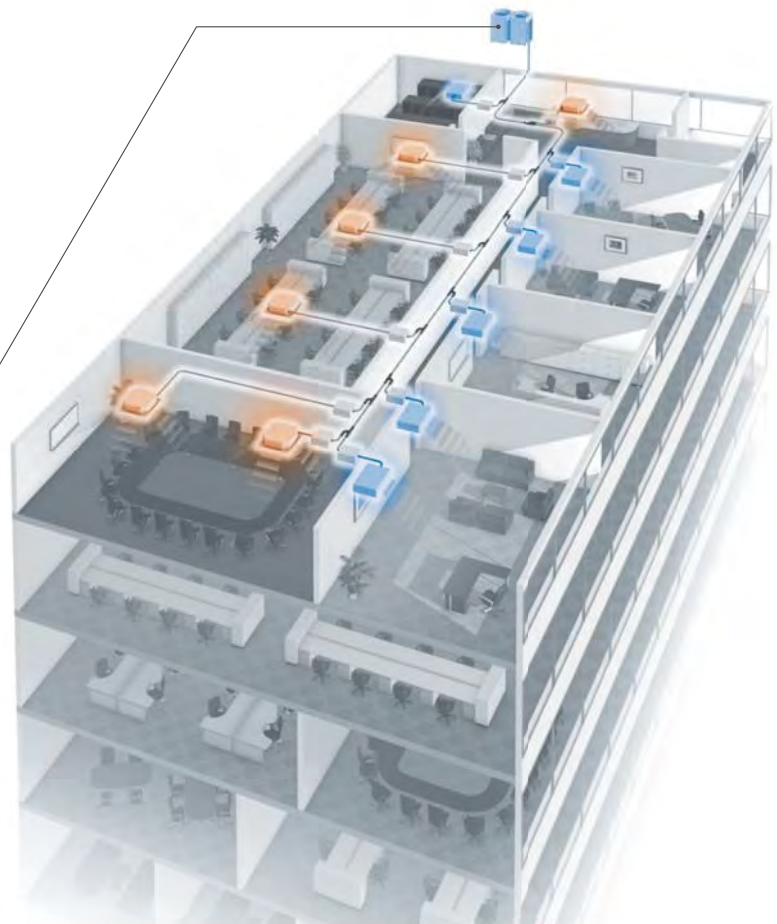

#### Individual air conditioning system for large buildings

AIRSTAGE VR IV outdoor units provide simultaneous heating and cooling up to 48HP.





## Centralised control

Not only indoor units in the building but also facilities such as ventilation can be controlled easily by anyone.



**System Controller**  
(UTY-APGXZ1)  
**System Controller Lite**  
(UTY-ALGXZ1 & UTY-PLGXX2)

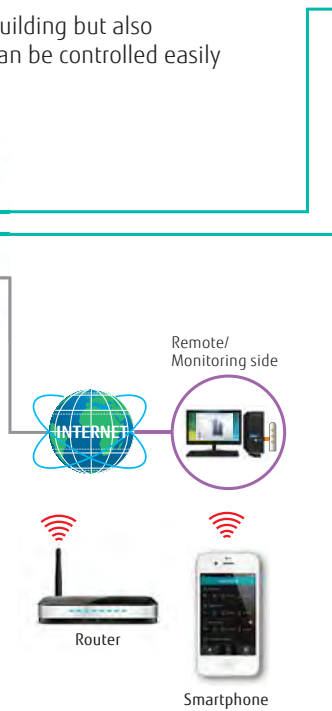

## Link up with a variety of BMS

It is possible to link up MODBUS, BACnet, KNX and other interfaces via Fujitsu BMS interfaces.

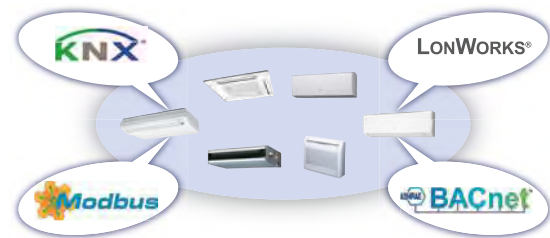

## High system flexibility

Flexible installation on each floor and installation of a variety of indoor unit styles. Outdoor units provides high static pressure, long piping design and connection capacity.

**82\*** Pa

\*: V-III, 80Pa for VR-IV

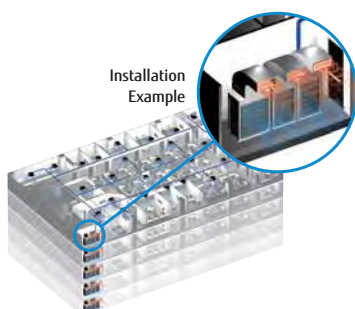

## Rapid service support

The air conditioning of the entire building can be monitored remotely with Web Monitoring Tool and System Controller.

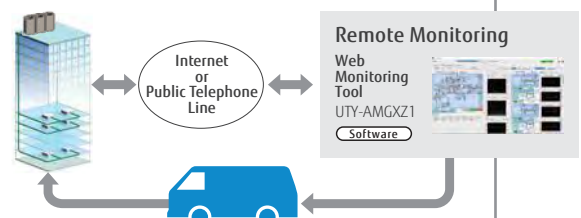



# Hotels

For Light Commercial

Fujitsu General provides total air conditioning systems that take into account comfort, energy saving, external appearance, safety and easy installation for small hotels.

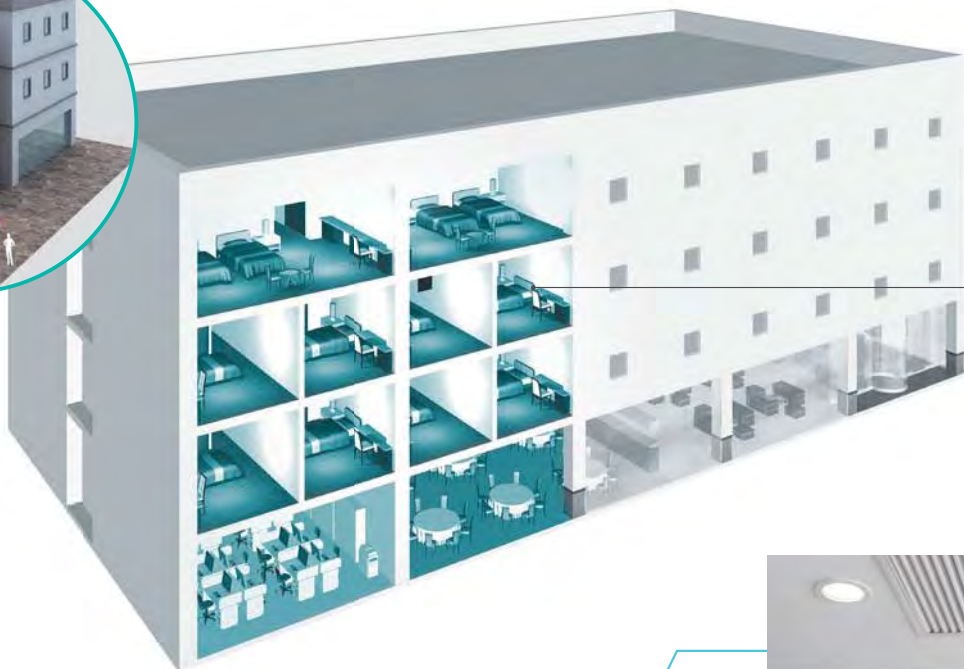
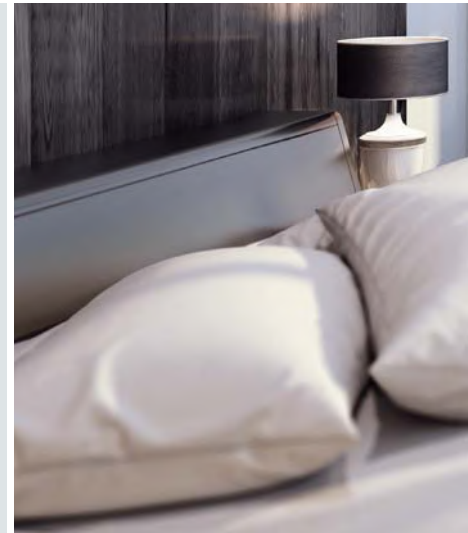

J-IV

J-IVL

J-IVL  
High capacity model

NEW

## AIRSTAGE™ J Series appearance-oriented compact outdoor unit

Due to the lowest and most compact design in the industry, the outdoor units can be positioned to minimize the impact on the buildings appearance.

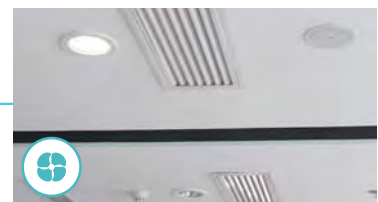

### Ventilation of the whole hotel supported

Outdoor air processing is essential in hotel spaces. The DX-Kit can link up with air handling units to ensure sufficient ventilation.



EEV unit

Control unit

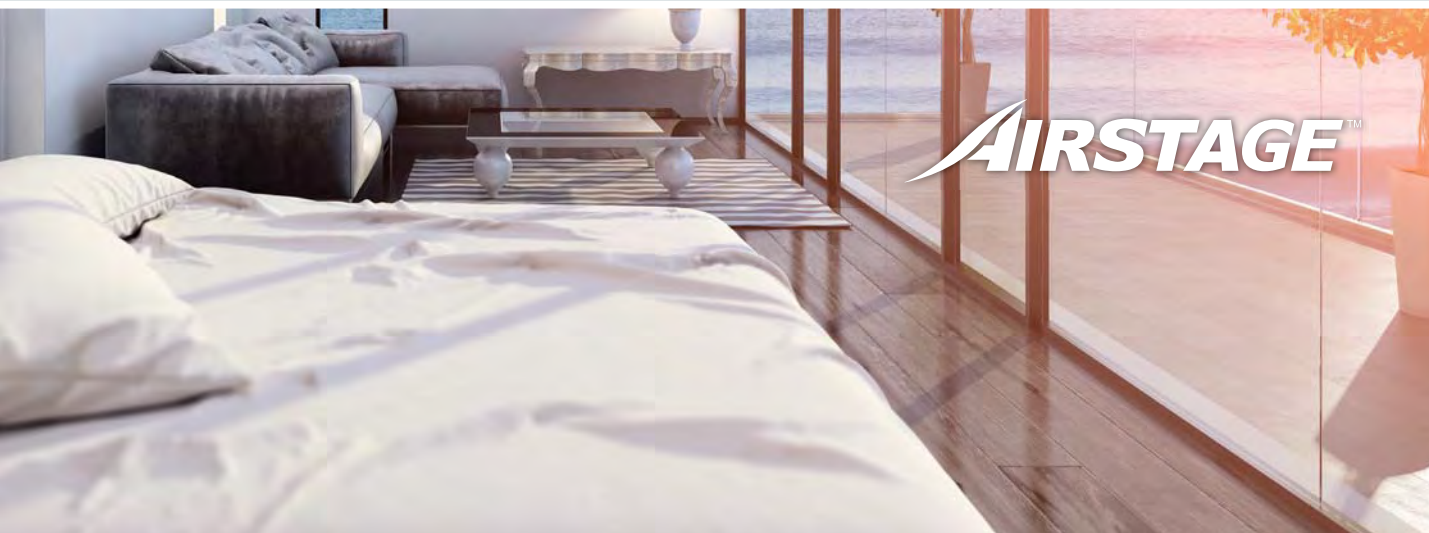

## Guest room air conditioning with excellent comfort, energy saving and easy installation

### Space saving

Mini duct type with 198 mm height and 450 mm depth. This can be installed in narrow ceiling space easily.



Mini Duct

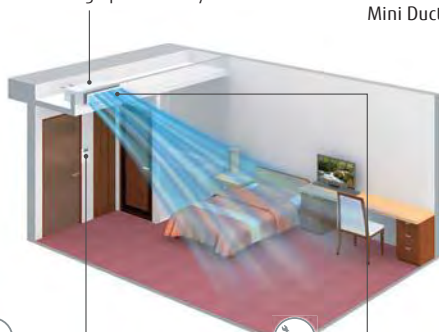

### Card key switch available

Using the card key prevents you from forgetting to switch off the air conditioner.

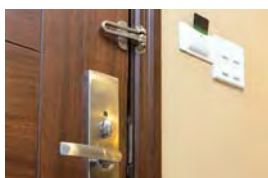

Use of an external connect switch



### Comfortable airflow from vertical louvre movement

The Auto Louvre Grille Kit achieves comfortable airflow by adjusting the air direction.



Auto Louvre Grille Kit



## Centralised control of air conditioning in shared spaces

Air conditioning in shared spaces such as lobbies and hallways is controlled centrally. Temperature and operating conditions can be managed without the adjustment by guests.



System controller



## Simple Remote Controller with sophisticated design

Suitable for hotels or offices as it is easily operated with no complex functions. Large LCD screen & simple operation buttons White coloured backlight on monitor enable easy operation in dark.



## Large space air conditioning in the reception and lobby

Ultra-large duct type single split system suitable for large spaces with high ceilings

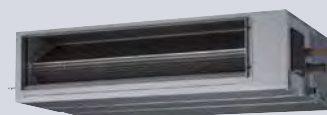



# School

## For Light Commercial

Fujitsu General provides the optimal number of connected indoor units for mid-sized educational institutions. The degree of freedom of the installation location is improved with a compact design that minimises the installation area.

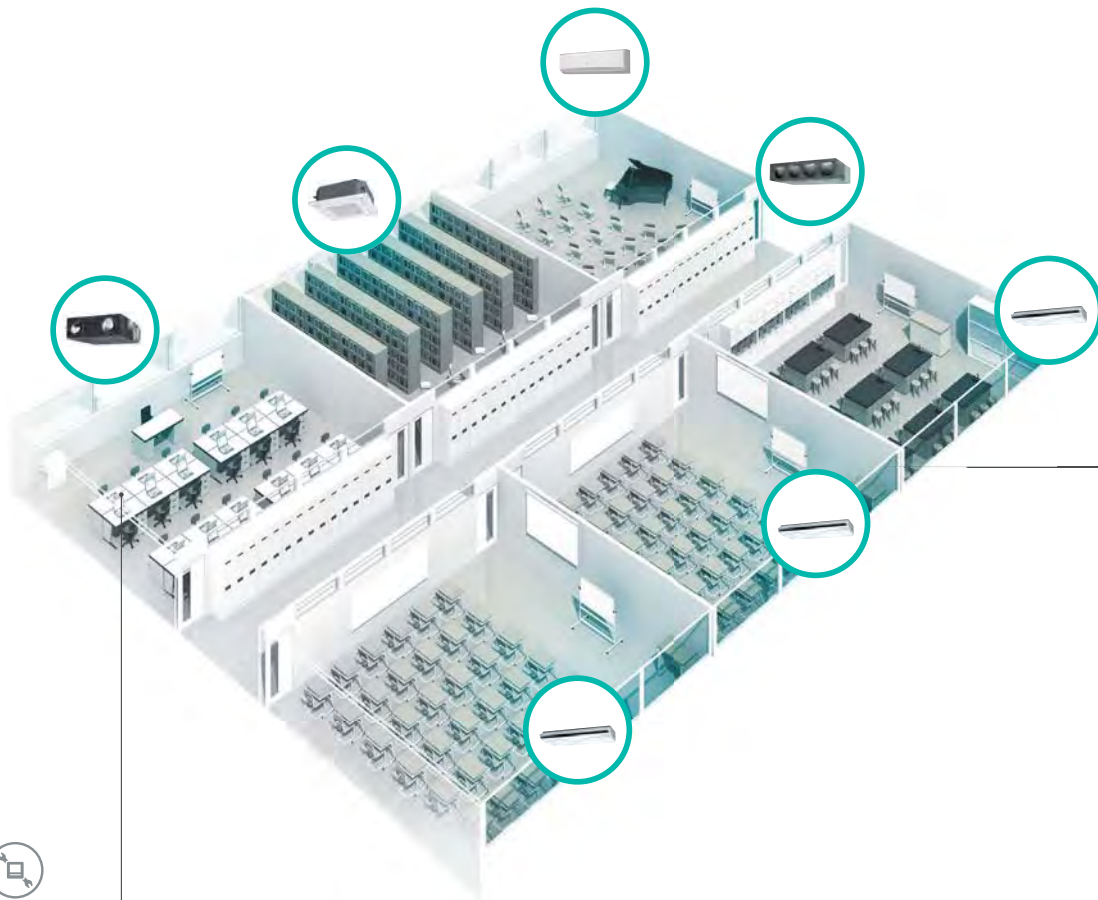

### Centralised control of both air conditioning and ventilation equipment

It is possible to perform centralised control including the operation of lighting and ventilation equipment in addition to air conditioners. This is useful in energy saving management over the whole building.

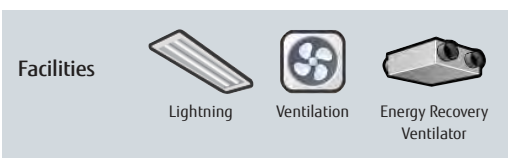

System Controller Lite



# AIRSTAGE™



Mini Duct



Medium Static Pressure Duct



Ceiling



Wall Mounted

## Various indoor units

We have a lineup of indoor units suitable for even the most complex applications – from normal classrooms to special classrooms and auditoriums. .

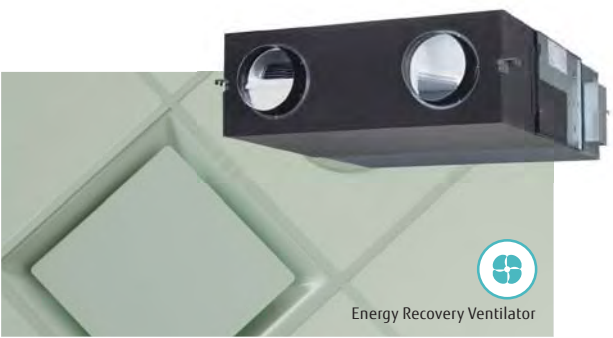

Energy Recovery Ventilator



Circular Flow Cassette

## Comfortable room air conditioning to all areas of the room

Circular Flow Cassette blows out in all directions without temperature unevenness



Individual airflow direction control to prevent people from being exposed to airflow



The optional human sensor reduces running costs by controlling the indoor unit based on the occupancy of the room.

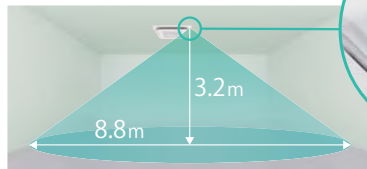

Human sensor (Option)

# More Comfort

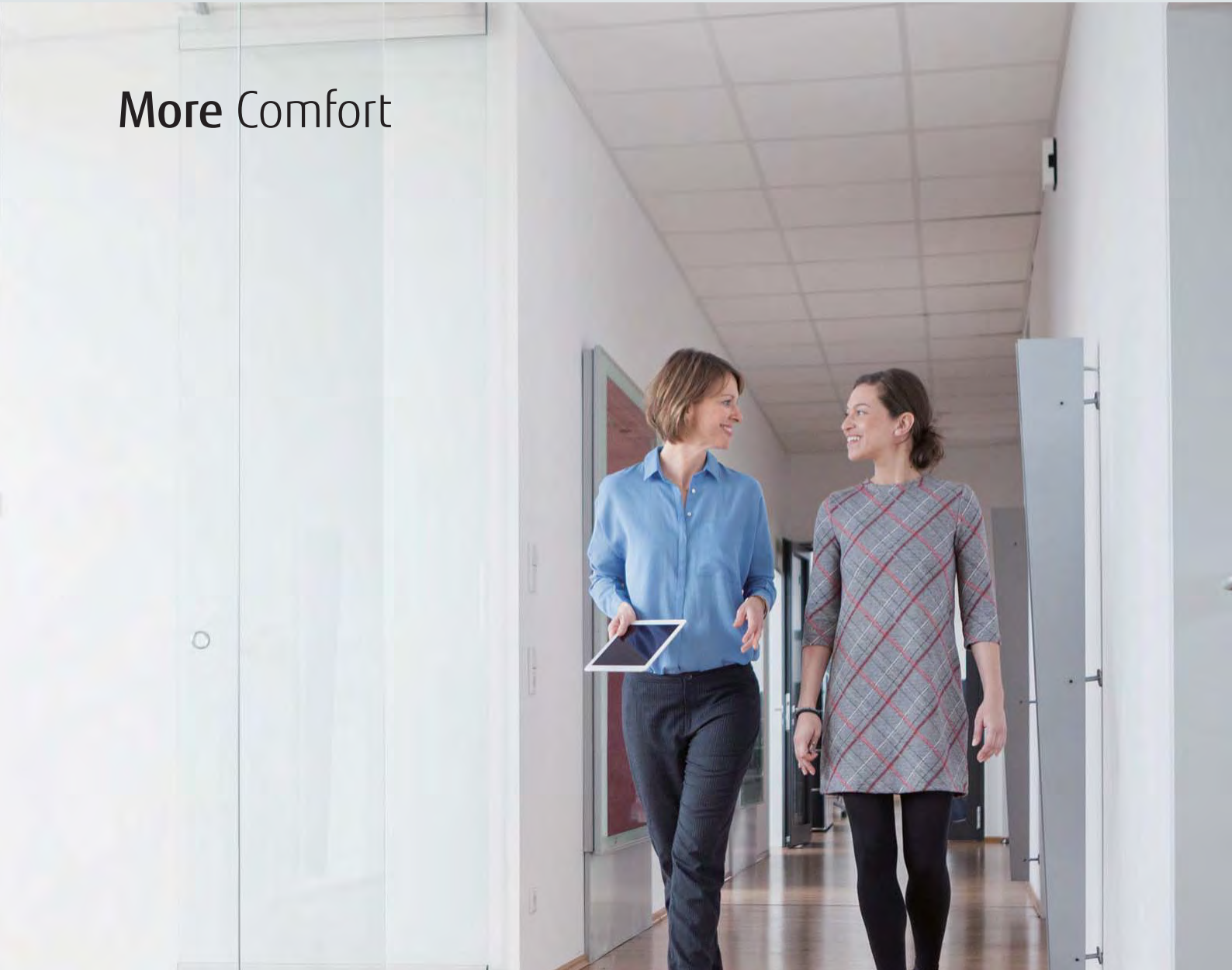

## Auto changeover function

The cooling/heating mode is automatically switched according to the set temperature and room temperature.

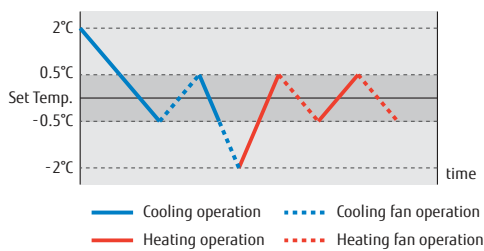

Auto changeover setting allows for the product to easily switch between cooling and heating modes regardless of the operation mode of other indoor units. This can be done via specific indoor unit with wired remote controller. This ensures comfortable operation all year round.

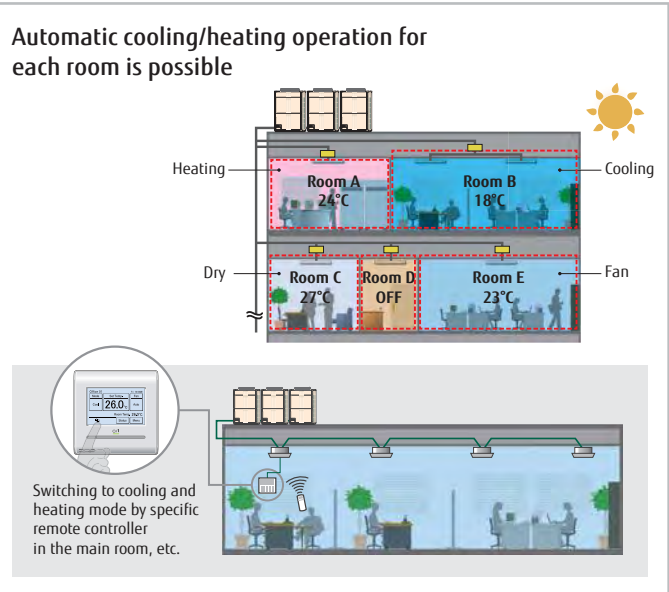

## Precision refrigerant flow control

Precise and smooth refrigerant flow control is achieved by using a DC Inverter control in conjunction with individual indoor unit electronic expansion valve control. This allows high precision comfortable temperature control of  $\pm 0.5^{\circ}\text{C}$ .

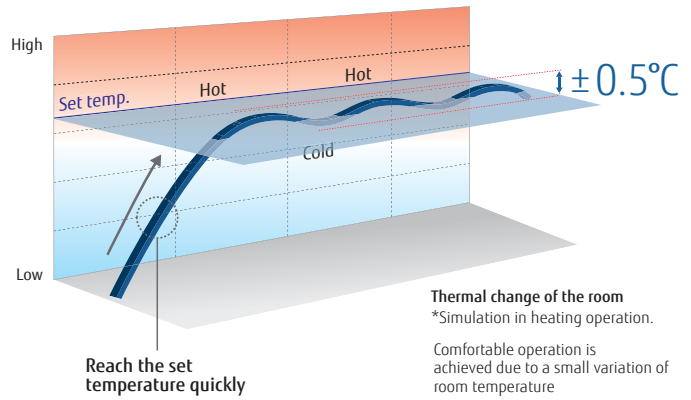

## Quiet operation



### Quiet operation

Two low noise modes can be selected automatically by quiet priority setting and capacity priority setting depending on the indoor environment and outside temperature load. This feature can be controlled via outdoor unit external input and/or system controller.

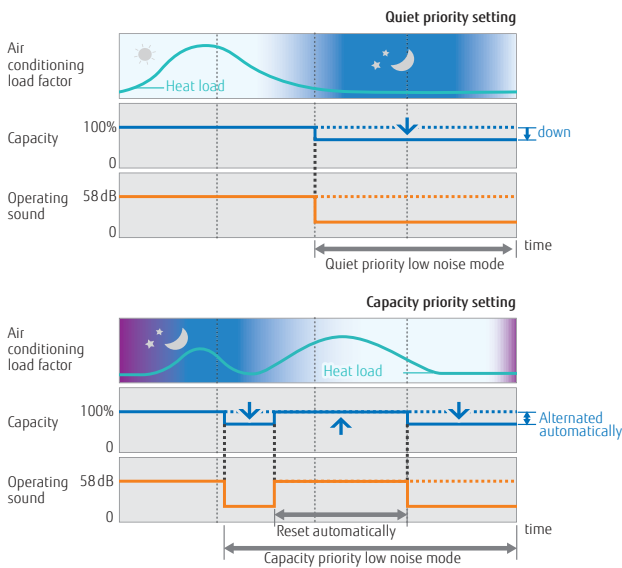

### Non-stop oil recovery operation

A comfortable room condition is maintained during oil recovery mode because the product continues to operate without stopping the cooling or heating operation.

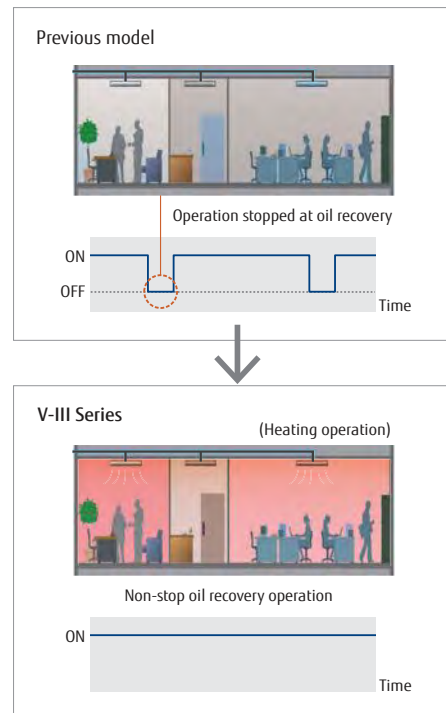

## Low sound level design

Small capacity indoor units respond to the demand of several applications.

These models will be able to offer comfortable environment by operating at super low sound levels. Especially, Wall mounted (EEV external) type is 19dB(A) when low mode heating operation.



# High Reliability

## Outdoor unit rotational operation

The compressor starting order is rotated so that the running time is shared.

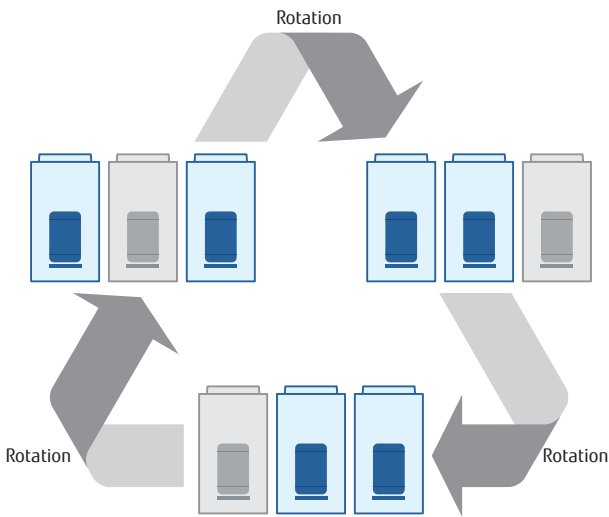

Note: Rotational operation is alternated by the start / stop timing of the compressor.

## Backup operation

If one compressor fails, backup operation will be performed by the remaining compressors\*.

\*: Note: Backup operation may not be possible depending on the trouble state.

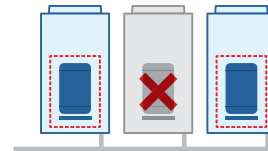

## Advanced refrigerant control

Innovative compressor control logic has been introduced in order to balance the refrigerant mass flow rate of each outdoor unit by controlling the inverter speed.

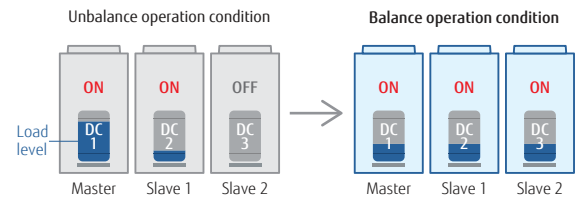

## Liquid flow back protection

By adopting a large sized accumulator, any liquid refrigerant stays inside of the accumulator to ensure no liquid refrigerant is being fed into the compressor.

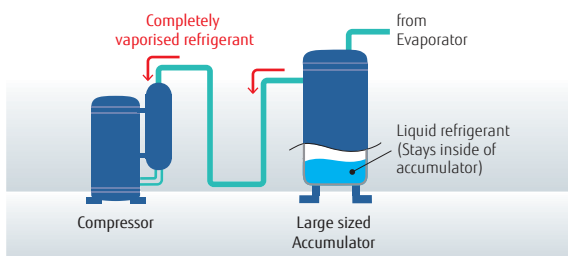

## Adoption of blue fin heat exchanger

Corrosion resistance of the heat exchanger has been improved by the introduction of blue fin treatment to the outdoor unit's heat exchanger.

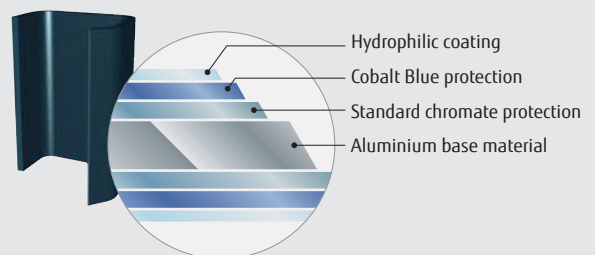



# Operation Performance is Efficiently Controlled.



## Room temperature set point limitation

The minimum and maximum temperature ranges can be limited, which provide energy saving while maintaining the comfort of the occupants.

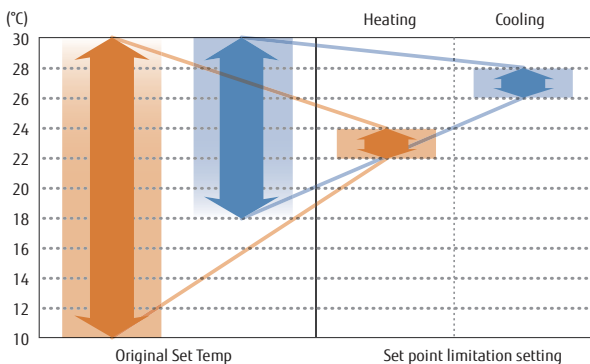

## Auto-off timer

New wired remote controller is equipped with an OFF timer function that automatically stops operation when a fixed time has elapsed from the start of operation. This prevents wasted of energy.

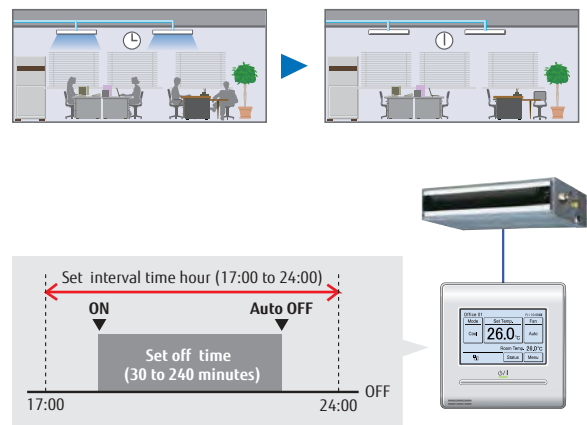

## New intelligent refrigerant control

New refrigerant control can be operated with suitable control corresponding to heat load of the room and can offer a more comfortable space. New refrigerant control can also provide more energy savings.

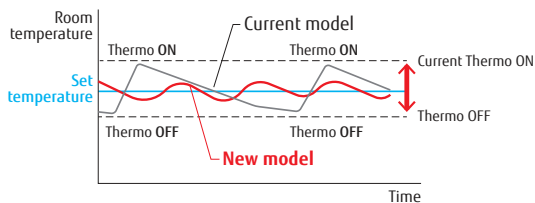

### Current refrigerant control

Thermostat-ON/OFF occurs frequently.  
→ The comfort is not good since room temperature often changes. Energy saving is not good since compressor is repeatedly starting and stopping frequently.

### New refrigerant control

Room target temperature is maintained as thermostat-ON/OFF occurs less than Current control. Energy saving is also improved.

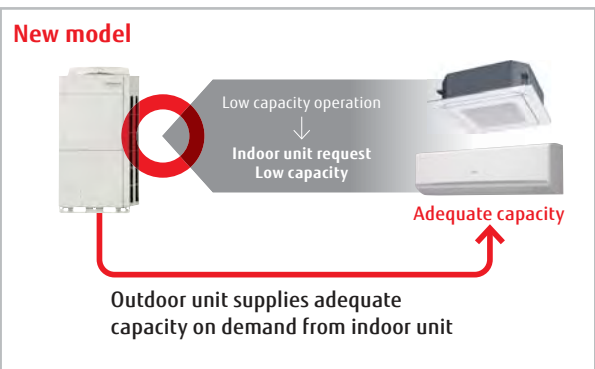
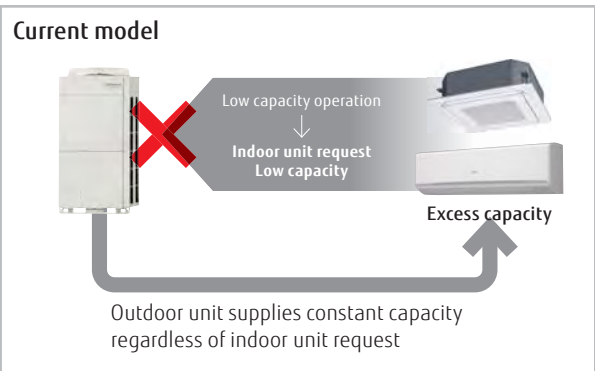

## Efficiency in actual operation

Top class high COP(Max. Heating) is achieved for all combinations by our unique heat exchanger structure, and highly efficient DC twin compressor.

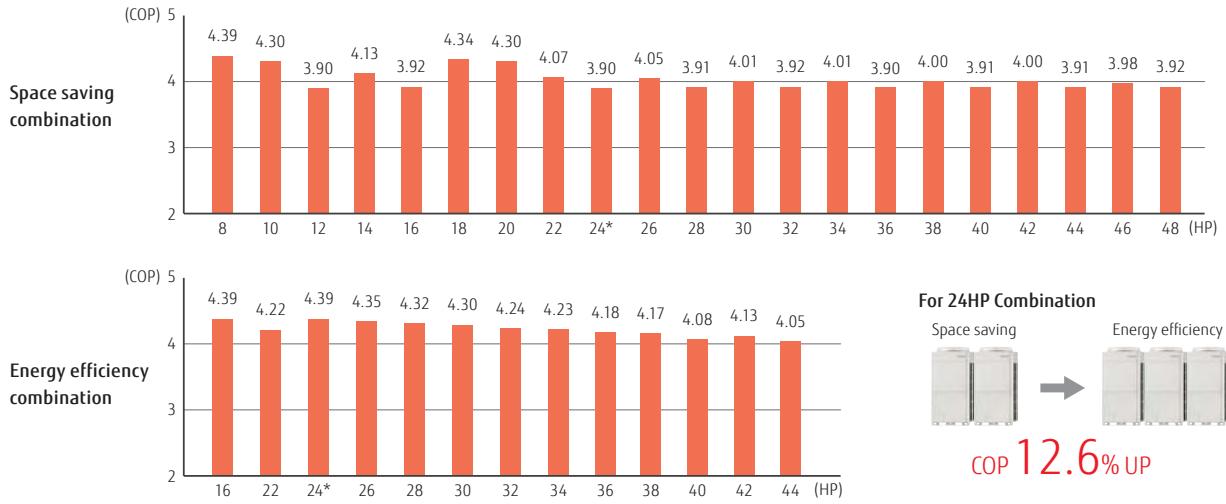

## All inverter compressor

### Large capacity DC inverter compressor

Large capacity highly efficient DC twin rotary compressor with excellent intermediate capability.

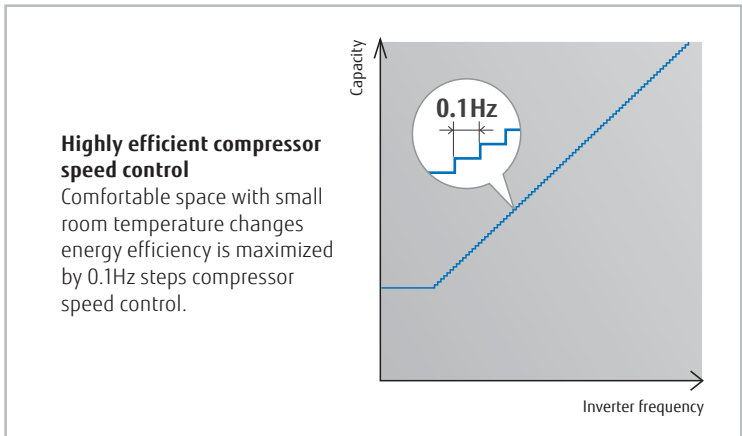

## Multiple outdoor operation control

When multiple outdoor units are connected a sophisticated operation is performed by each compressor. Rather than running one compressor at full load and distributing refrigerant to one heat exchanger, this control method operates all compressors at part load and distributes refrigerant to all of the heat exchangers which allows for the overall system efficiency to be improved.

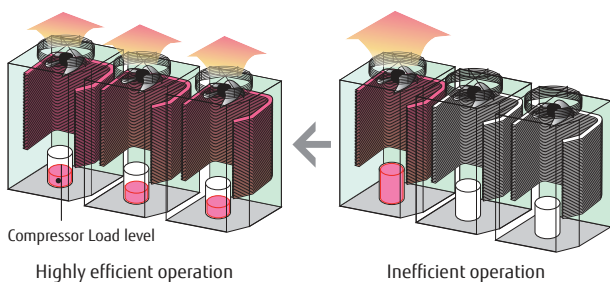

## Heat exchanger refrigerant control

The heat exchanger in the outdoor unit is split into two parts (Top and Bottom). The efficiency of the heat exchanger has been improved by adopting an optimum refrigerant path control where the refrigerant is distributed more into the top heat exchanger as this is where there is a greater air flow intake.

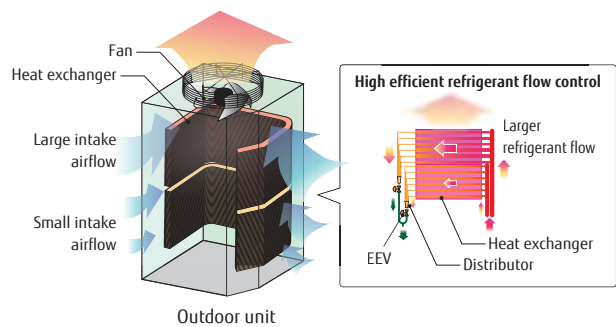

# High Efficiency

Efficiency is improved significantly by using DC twin rotary compressor, inverter technology, and large heat exchanger



DC twin rotary compressor

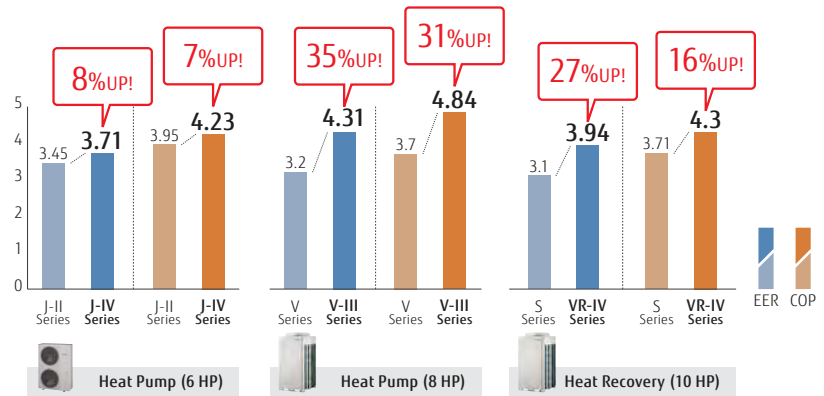

**ALL DC** High efficiency design with top class SEER/SCOP

All VRF Series including J-IVL Series have DC technology to realise the high efficiency operation. This enhances the durability and reliability of VRF Series.



J-IVL Series

J-IV Series

J-IVS Series

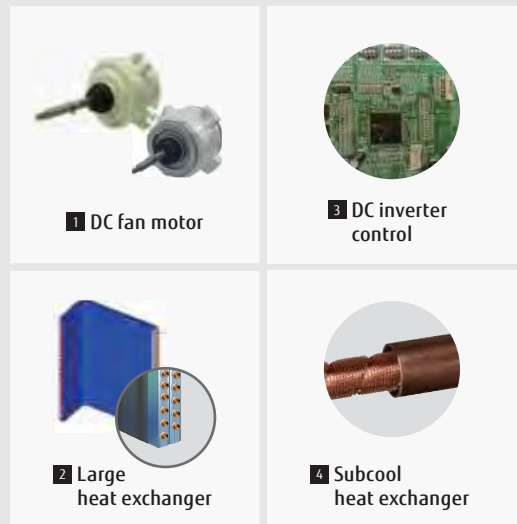

V Series



# Design Flexibility



## Top class Compact design



Compact outdoor units are at the top of the class in the industry with an optimal compact design. (Up to 18 HP)



## Long piping design



Piping design suitable for long, narrow office buildings with a large elevation difference are also possible.

(AIRSTAGE™ J-IVL Series)

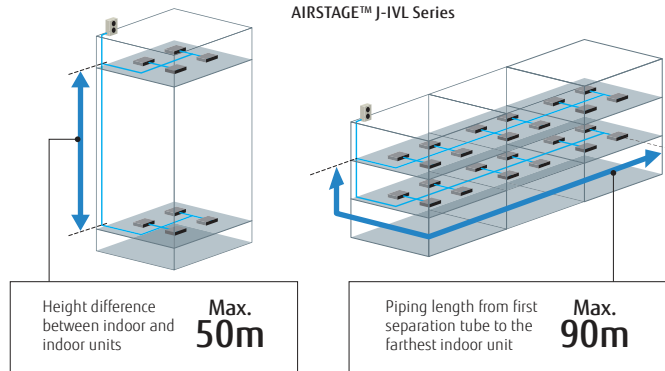

## Overall piping length Max. 1,000 m



World's top class overall piping length of 1,000 m allows for application in a wide variety of buildings.

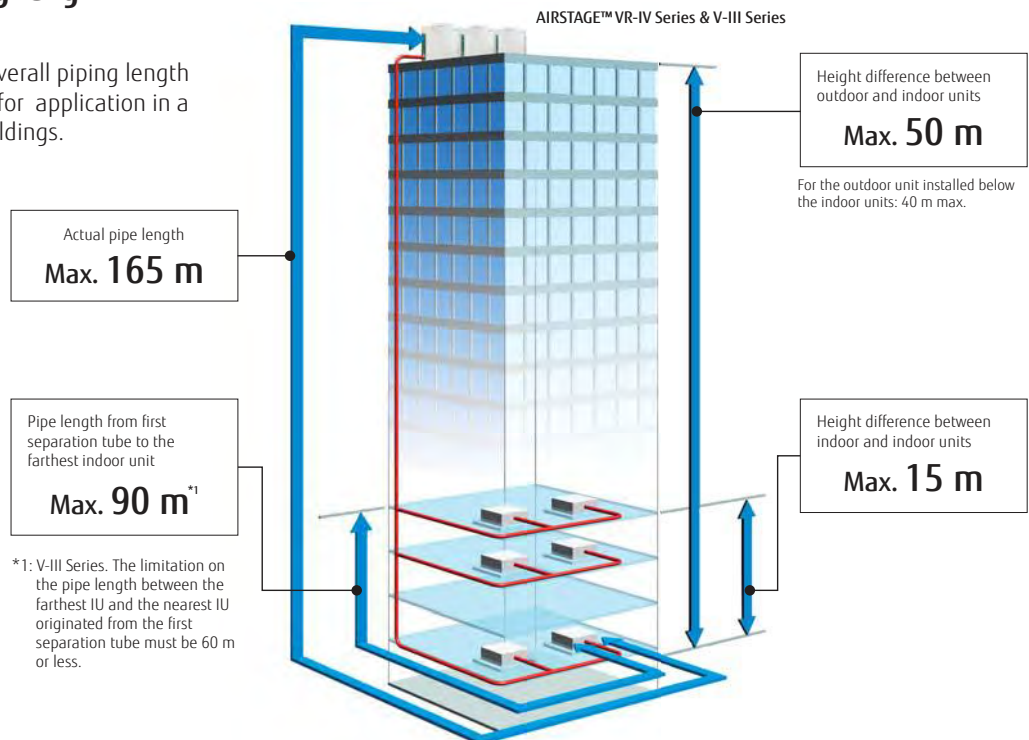

## High capacity connection

Series	Connectable indoor unit capacity range	Connectable indoor unit number
AIRSTAGE™ J-IVL Series 14/16/18 HP Heat Pump type	50% to 150%* <sup>2</sup>	up to 42* <sup>4</sup>
AIRSTAGE™ J-IVL Series 8/10/12 HP Heat Pump type	50% to 150%* <sup>2</sup>	up to 30* <sup>5</sup>
AIRSTAGE™ J-IV Series Heat Pump type	50% to 150%* <sup>2</sup>	up to 14* <sup>6</sup>
AIRSTAGE™ J-IVS Series Heat Pump type	50% to 130%* <sup>2</sup>	up to 13
AIRSTAGE™ VR-IV Series Heat Recovery Modular type	25%* <sup>7</sup> to 150%* <sup>2</sup>	up to 64
AIRSTAGE™ V-III Series Heat Pump Modular type	50% to 150%* <sup>3</sup>	up to 64

\*2: Conditions of maximum connectable indoor unit capacity ratio is as the chart.

\*3: Max. capacities in the combinations including the 18 HP outdoor unit fall below 150%.

\*4: J-IVL Series 18 HP model only.

\*5: J-IVL Series 12 HP model only.

\*6: J-IV Series 6 HP model only.

\*7: For modular type, 25% to 49.9% operation in the entire system is available. (by one unit operation)



### Designed for low refrigerant charge

Optimal design of indoor unit and outdoor unit reduces the refrigerant volume and special detection is not required even when installing in a small room of about 15 m<sup>2</sup>.



### Various optional parts

- Intake fresh air with our Fresh Air Intake kit
- Comfortable temperature control with a remote sensor
- Operation by linking up to ventilation equipment and air handling unit with the DX-Kit



Fresh Air Intake kit



EEV unit



Control unit



### Low ambient operation

Refrigeration cycle technology allows cooling operation even at -15°C.



## Wide operating range

Installation in extreme temperature conditions is possible due to an increase in operational range.

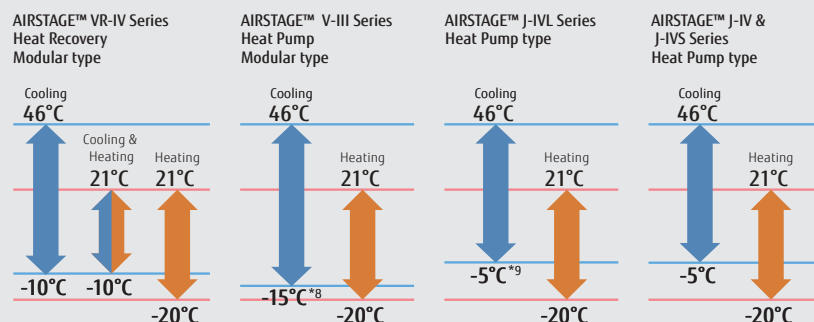

\*8: Note: When a multiple outdoor unit connection is used, operating range is from -5°C to 46°C in cooling.

\*9: Only when all indoor units are 5.6 kW or more in the system, the operation range is -15°C to 46°C.

# Easy Installation

## Easily transported

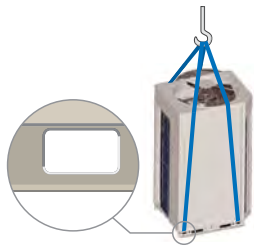

**Easily craned using lifting belt hooks**  
Design of outdoor unit allows for lifting straps to be used

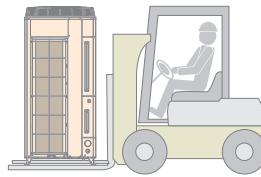

**Transporting by forklift**  
Transport with forklift is possible.



**Can be transported in a small elevator**

## Easy access

By adopting a L-Shape front panel that can be removed, the workspace for installation and service has been significantly expanded by this new design. For multiple installations, work is performed easily and efficiently even in a narrow space.

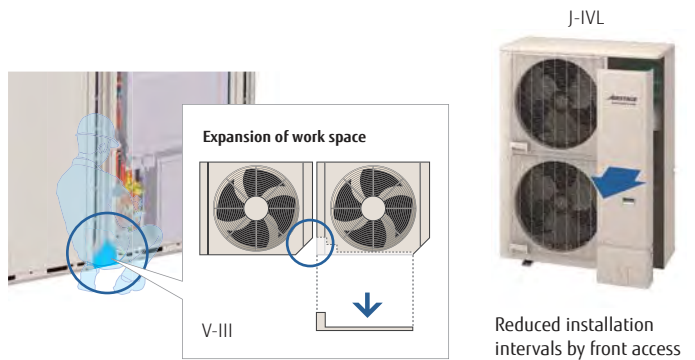

## Flexible piping connection

Piping and wiring are available to the front, left and right, and bottom.





### Simple wiring work

Installation of the wiring systems is made easier as the communication wiring can be installed in parallel or in series between the indoor, outdoor and RB units.

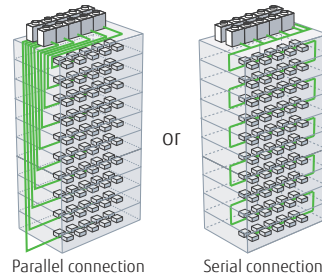

Up to maximum length  
**3,600 m**

Note: Serial connection can't use the automatic address setting in a multiple refrigerant system.

### Easy evacuation - using vacuum mode function

The vacuum mode function enables all expansion valves of indoor units to be fully opened, making it easy to evacuate all the air inside pipe lines and indoor units.

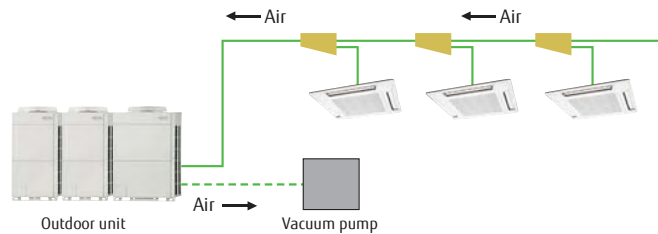

### Automatic address setting

The address of the indoor unit, RB unit and signal amplifier through the automatic function setting on the outdoor unit PCB.

Automatic address setting is performed at outdoor unit

Addresses are automatically distributed from outdoor unit.



Press the push button of outdoor unit.

Manual address setting from indoor unit and remote controller is also possible.

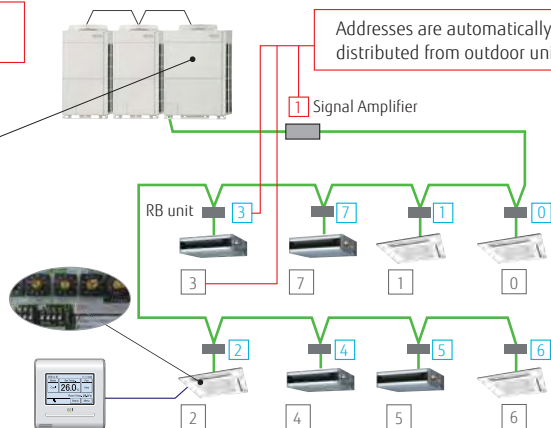

### Easy commissioning by Service Tool

Service tools can be used to check the refrigerant temperature, pressure, and the operating status of the electronic expansion valve, making it easy to determine whether the units are connected properly.



# Easy Service & Maintenance

## Design for Easy Maintenance

7 segment LED is used to make it easy to check the details about the function setting status, refrigerant temperature, pressure, compressor operation time, and other factors for each model to make it easy to perform self-diagnostics.

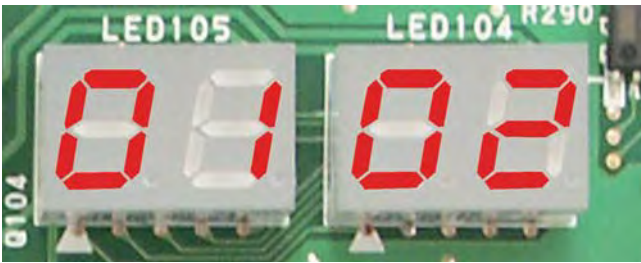

### Easy to read 7-segment LED :

Confirm detailed operational and error status without using any specific equipment.

### Error status can be checked easily by outdoor unit display

- Operation mode status
- Discharge temperature/Pressure status
- Compressor operation indication
- Address/type/number of outdoor unit

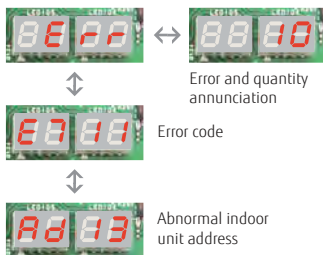

- Error status can be checked easily by outdoor unit display

### Movable PCB panel

Easier for maintenance work behind the PCB







## Error status can be checked easily via the indoor unit wired controller

An error code is displayed on a liquid crystal screen.

Simple Remote Controller	Wired Remote Controller (Touch panel)																																			
<p>Remote controller address</p> <p>Error code</p>	<p>Error status / Error history</p> <table border="1"> <thead> <tr> <th>No.</th> <th>Date</th> <th>Time</th> <th>Address</th> <th>Code</th> </tr> </thead> <tbody> <tr> <td>1</td> <td>2009/2/11</td> <td>11:00AM</td> <td>00000</td> <td>141</td> </tr> <tr> <td>2</td> <td>2009/7/20</td> <td>12:50M</td> <td>00000</td> <td>142</td> </tr> <tr> <td>3</td> <td>2009/7/20</td> <td>12:50M</td> <td>00000</td> <td>143</td> </tr> <tr> <td>4</td> <td>2009/7/20</td> <td>11:00AM</td> <td>00000</td> <td>141</td> </tr> <tr> <td>5</td> <td>2009/7/20</td> <td>11:00AM</td> <td>00000</td> <td>141</td> </tr> <tr> <td>6</td> <td>2009/7/20</td> <td>11:00AM</td> <td>00000</td> <td>141</td> </tr> </tbody> </table>	No.	Date	Time	Address	Code	1	2009/2/11	11:00AM	00000	141	2	2009/7/20	12:50M	00000	142	3	2009/7/20	12:50M	00000	143	4	2009/7/20	11:00AM	00000	141	5	2009/7/20	11:00AM	00000	141	6	2009/7/20	11:00AM	00000	141
No.	Date	Time	Address	Code																																
1	2009/2/11	11:00AM	00000	141																																
2	2009/7/20	12:50M	00000	142																																
3	2009/7/20	12:50M	00000	143																																
4	2009/7/20	11:00AM	00000	141																																
5	2009/7/20	11:00AM	00000	141																																
6	2009/7/20	11:00AM	00000	141																																

## Error diagnosis by Service Tool

### Connection to Service Tool

- Detailed operation status and recent error history can be checked and analysed by using the Service Tool.
- Last 5 min. operation memory can also be recorded.

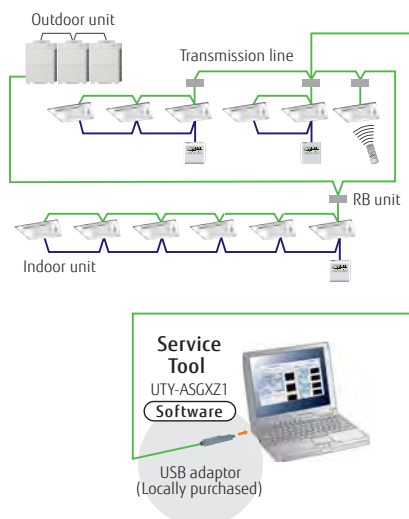







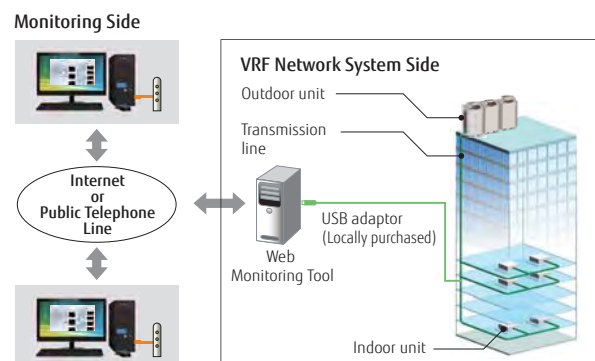































## Remote monitoring













































The Web Monitoring system allows you to view system operation anytime over the internet, ensuring issue free operation.

The operating VRF network system in the building can be monitored real time over the Internet.

















































# VRF Outdoor Units Lineup

Capacity (kW)		12.1	14.0	15.1-15.5	22.4	28.0	33.5	40.0	45.0	50.4	55.9	61.5	67.0	73.5
HP		4	5	6	8	10	12	14	16	18	20	22	24	26
J-III Series Page 122														
		AJY040 LBLAH, AJY040 LELAH	AJY040 LBLAH, AJY040 LELAH	AJY054 LBLAH, AJY054 LELAH										
J-IIIIL Series Page 124~														
					AJY072 LELAH	AJY090 LELAH	AJY108 LELAH	AJY126 LELAH	AJY144 LELAH	AJY162 LELAH				
VR-II Series Heat Recovery	Space Saving Page 130~													
	Set Model				AJYA72 GALH	AJYA90 GALH	AJY108 GALH	AJY126 GALH	AJY144 GALH	AJY162 GALH	AJY180 GALH	AJY198 GALH	AJY216 GALH	AJY234 GALH
	Energy Efficiency Page 130~													
	Set Model							AJY144 GALHH		AJY198 GALHH	AJY216 GALHH	AJY234 GALHH		
V-III Series Heat Pump	Space Saving Page 134~													
	Set Model				AJY072 LALBH	AJY090 LALBH	AJY108 LALBH	AJY126 LALBH	AJY144 LALBH	AJY162 LALBH	AJY180 LALBH	AJY198 LALBH	AJY216 LALBH	AJY234 LALBH
	Energy Efficiency Page 134~													
	Set Model							AJY144 LALBHH	AJY162 LALBHH	AJY180 LALBHH		AJY216 LALBHH	AJY234 LALBHH	

78.5 28	85.0 30	90.0 32	95.0 34	100.5 36	107.0 38	112.0 40	118.5 42	123.5 44	130.0 46	135.0 48	140.0 50	145.0 52	150.0 54
 AJY252 GALH	 AJY270 GALH	 AJY288 GALH	 AJY306 GALH	 AJY324 GALH	 AJY342 GALH	 AJY360 GALH	 AJY378 GALH	 AJY396 GALH	 AJY414 GALH	 AJY432 GALH			
 AJY252 GALHH	 AJY270 GALHH	 AJY288 GALHH	 AJY306 GALHH	 AJY324 GALHH	 AJY342 GALHH	 AJY360 GALHH	 AJY378 GALHH	 AJY396 GALHH					
 AJY252 LALBH	 AJY270 LALBH	 AJY288 LALBH	 AJY306 LALBH	 AJY324 LALBH	 AJY342 LALBH	 AJY360 LALBH	 AJY378 LALBH	 AJY396 LALBH	 AJY414 LALBH	 AJY432 LALBH	 AJY450 LALBH	 AJY468 LALBH	 AJY486 LALBH
 AJY252 LALBHH	 AJY270 LALBHH	 AJY288 LALBHH	 AJY306 LALBHH	 AJY324 LALBHH	 AJY342 LALBHH	 AJY360 LALBHH	 AJY378 LALBHH	 AJY396 LALBHH	 AJY414 LALBHH				

# New VRF IV Range Outdoor Units Lineup

Capacity (kW)	12.1	14.0	15.1-15.5	22.4	28.0	33.5	40.0	45.0	50.0-50.4	55.9	61.5	67.0	73.5
HP	4	5	6	8	10	12	14	16	18	20	22	24	26
<div style="display: flex; align-items: center;"> <div style="width: 20px; height: 10px; background-color: red; margin-right: 5px;"></div> <div> <p><b>J-IVL Series</b></p> </div> </div>													
<div style="display: flex; align-items: center;"> <div style="width: 20px; height: 10px; background-color: red; margin-right: 5px;"></div> <div> <p><b>J-IV Series</b></p> </div> </div>													
<div style="display: flex; align-items: center;"> <div style="width: 20px; height: 10px; background-color: red; margin-right: 5px;"></div> <div> <p><b>J-IVS Series</b></p> </div> </div>													
<div style="display: flex; align-items: center;"> <div style="width: 20px; height: 10px; background-color: red; margin-right: 5px;"></div> <div style="writing-mode: vertical-rl; transform: rotate(180deg);"> <p><b>VR-IV Series Heat Recovery</b></p> </div> </div>	Space Saving												
	Set Model			AJY072 GALBH	AJY090 GALBH	AJY108 GALBH	AJY126 GALBH	AJY144 GALBH	AJY162 GALBH	AJY180 GALBH	AJY198 GALBH	AJY216 GALBH	AJY234 GALBH
	Energy Efficiency												
Set Model							AJY144 GALBHH			AJY198 GALBHH	AJY216 GALBHH	AJY234 GALBHH	

78.5 28	85.0 30	90.0 32	95.0 34	100.5 36	107.0 38	112.0 40	118.5 42	123.5 44	130.0 46	135.0 48	140.0 50	145.0 52	150.0 54
 AJY252 GALBH	 AJY270 GALBH	 AJY288 GALBH	 AJY306 GALBH	 AJY324 GALBH	 AJY342 GALBH	 AJY360 GALBH	 AJY378 GALBH	 AJY396 GALBH	 AJY414 GALBH	 AJY432 GALBH			
 AJY252 GALBHH	 AJY270 GALBHH	 AJY288 GALBHH	 AJY306 GALBHH	 AJY324 GALBHH	 AJY342 GALBHH	 AJY360 GALBHH	 AJY378 GALBHH	 AJY396 GALBHH					

# AIRSTAGE™ J Series Overview

Fujitsu General provides air conditioning systems for a wide range of applications from small office buildings and hotels to large stores, houses.





**NEW** Max. 18 HP Heat Pump  
**AIRSTAGE™ J-IVL**

J-IVL is an outdoor unit with a slim design offering a high degree of freedom of installation that is recommended for mid-size office buildings and hotels. Furthermore, you can connect up to 42\* indoor units with the newly added 14/16/18 HP models. 14/16/18 HP models are also ideal for hospitals and educational facilities with many rooms.

\*: 18 HP model

**Slim Outdoor Unit**

Although this is a 14/16/18 HP model that can handle slightly larger requirements, it has a slim depth of 480 mm. This model can be installed even in limited spaces.

**Small room application**

Up to 30-42 indoor units can be connected by the optimum heat exchanger structure. Available to various small rooms.

**Top Class Low Operating Sound**

Low operating sound levels are achieved making the unit suitable for densely populated areas.



8-12 HP models

14/16/18 HP models

**NEW** Max. 6 HP Heat Pump  
**AIRSTAGE™ J-IV**

J-IV allows the system to connect up to 13 indoor units. This model is suitable for small buildings and residential applications.

**High Energy Efficiency**

Heat pump inverter control is used to achieve an efficient cooling and heating operation with any indoor unit combination.

**Flexible systems for small- and medium-size buildings air conditioning**

Space saving design and long piping design allow flexible installations on the roofs or balconies of small and medium-size buildings. Multiple indoor units of various capacities and types can be connected.



**NEW** Max. 6 HP Heat Pump, Compact Design  
**AIRSTAGE™ J-IVS**

J-IVS has a compact design with a height of 998 mm that does not obstruct visibility even when installed near waist-high windows. This model is also ideal for large houses, retail stores and other properties.

**Space saving and low sound level design**

Economical individual air conditioning is realised by ALL-DC technology, large capacity DC twin rotary compressor, and the compact 3-row heat exchanger.

**Flexible systems for homes, shops, small-size buildings air conditioning**

Due to compact size design and flexible piping design, the J-IVS Series can be installed easily at the place where the installation space is limited such as homes, shops, and small offices. Multiple indoor units of various capacities and types can be connected.



# Heat Pump

for Small Capacity Type

## AIRSTAGE™ J-IVS

### It Can be Easily Positioned and Installed

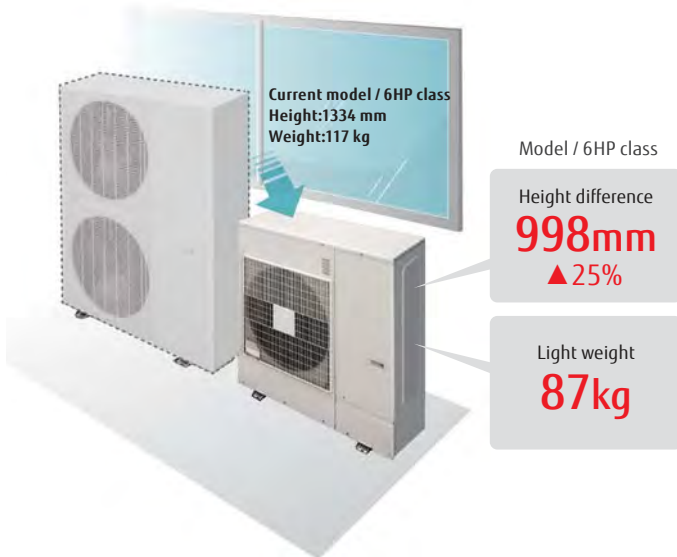

### Small and light weight outdoor unit

This model is much more compact than conventional 6HP comparable outdoor units. Even when installed on the balcony it fits within the height of the fence. The compact size with a height of less than 1 m allows it to be installed under windows and in tight spaces



### Low sound level design

Significantly low sound level is realised by using DC twin rotary compressor, inverter technology, and advanced airflow structure design.

### Long piping length

Our advanced refrigerant control technology allows us to achieve a total refrigerant piping length of 80 m. This opens up possibilities in system design.

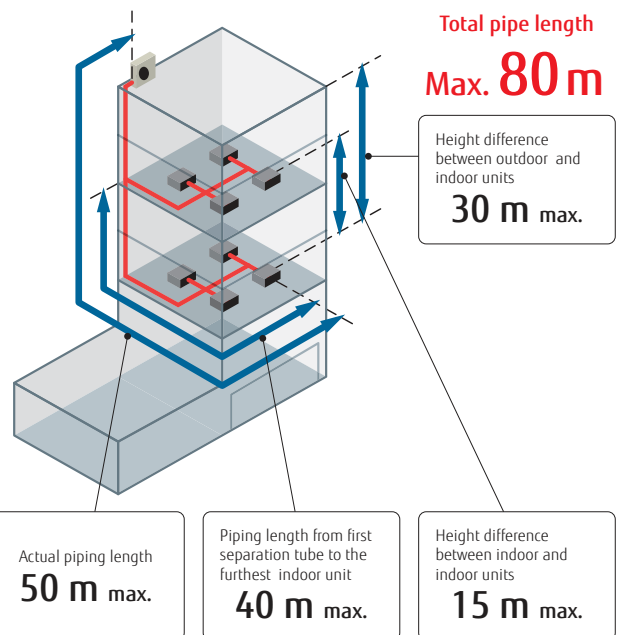

### Up to 13 units\* can be connected

Improvements in the design of the outdoor heat exchanger combined with our new 1.1kW indoor units mean that up to 13 indoor units can be connected.

\*: 6 HP model

Model	Current model (J-IIS)			New model (J-IVS)		
	4	5	6	4	5	6
Rating Capacity range (HP)	4	5	6	4	5	6
Max. Connectable indoor unit	1-7	1-8	1-8	1-11	1-12	1-13





NEW

Specifications

Rating Capacity range		HP	4	5	6
Model name			AJY040LCLBH	AJY045LCLBH	AJY054LCLBH
Maximum Connectable Indoor Unit			1-11	1-12	1-13
Power source			Single phase, ~230V, 50Hz		
Capacity	Cooling	kW	12.1	14.0	15.1
	Nominal Heating		12.1	14.0	15.1
	Max Heating		13.6	16.0	16.5
Input power	Cooling	kW	3.44	4.43	5.03
	Nominal Heating		2.55	3.11	3.52
	Max Heating		3.27	3.93	4.11
EER	Cooling		3.52	3.16	3.00
COP	Nominal Heating		4.74	4.51	4.30
	Max Heating		4.16	4.07	4.01
Airflow rate		m <sup>3</sup> /h	4,040	4,200	4,200
Sound pressure level / Power level	Cooling	dB(A)	51 / 67	53 / 69	54 / 70
	Heating		54 / 68	56 / 69	56 / 70
Heat exchanger fin			Blue fin	Blue fin	Blue fin
Net Dimensions	Height	mm	998	998	998
	Width		970	970	970
	Depth		370	370	370
Weight		kg	86	86	87
Refrigerant	Type (Global Warming Potential)		R410A (2,088)	R410A (2,088)	R410A (2,088)
	Charge	kg(CO2eq-T)	4.0 (8.4)	4.0 (8.4)	4.0 (8.4)
Connection pipe diameter	Liquid	mm	9.52	9.52	9.52
	Gas		15.88	15.88	15.88
Total pipe length		m	80	80	80
Max. height difference		m	30	30	30
Operation range	Cooling	°C	-5 to 46	-5 to 46	-5 to 46
	Heating		-20 to 21	-20 to 21	-20 to 21

Note : Specifications are based on the following conditions.  
 Cooling : Indoor temperature of 27°CDB / 19°CWB, and outdoor temperature of 35°CDB / 24°CWB.  
 Heating : Indoor temperature of 20°CDB / (15°CWB), and outdoor temperature of 7°CDB / 6°CWB.  
 Pipe length : 7.5 m; Height difference between outdoor unit and indoor unit : 0 m.  
 The protective function may work when using it outside the operation range.

Dimensions

(Unit : mm)

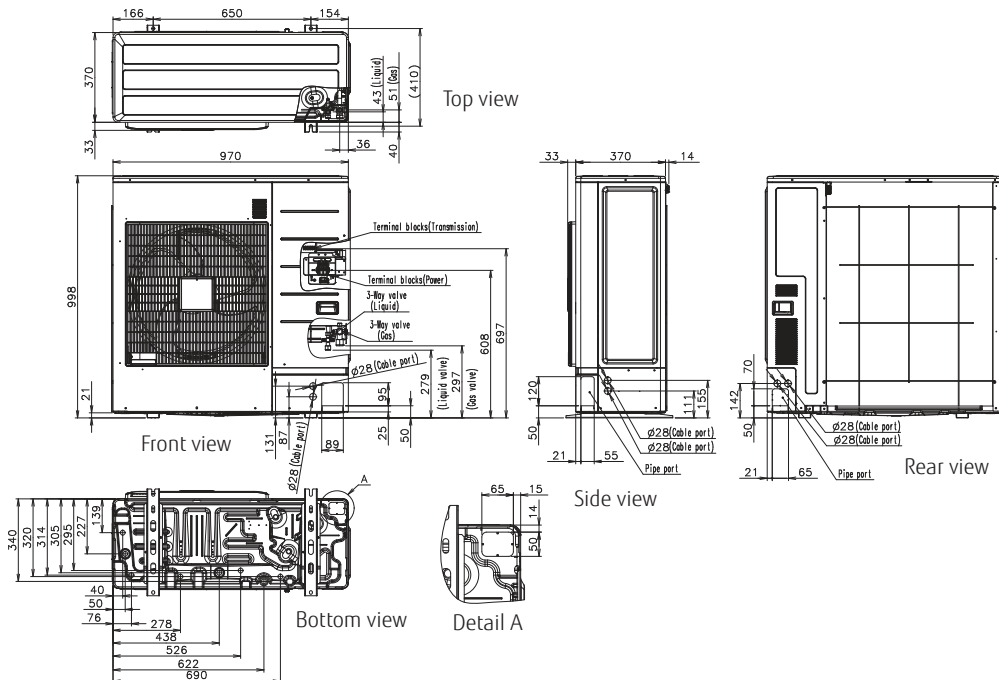

# Heat Pump for Small Capacity Type

**AIRSTAGE™ J-III**



## Long Piping Length

Our advanced refrigerant control technology allows us to achieve a total refrigerant piping length of 180 m. This opens up new possibilities in system design.



Total pipe length  
**Max. 180 m**

Height difference between outdoor and indoor units  
**50 m max.**

For the outdoor unit installed below the indoor units: 40 m max.

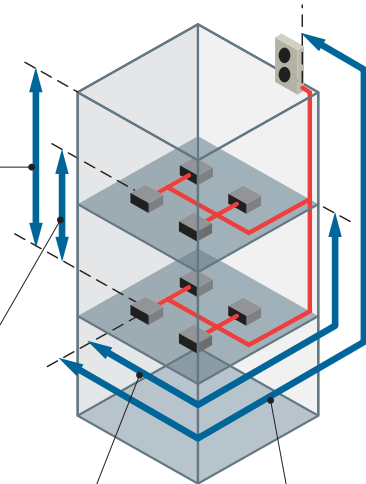

Height difference between indoor and indoor units  
**15 m max.**

Piping length from first separation tube to the furthest indoor unit  
**40 m max.**

Actual piping length  
**120 m max.**

## Non-stop oil recovery operation

A comfortable room condition is maintained during oil recovery mode because the product continues to operate without stopping the cooling or heating operation.

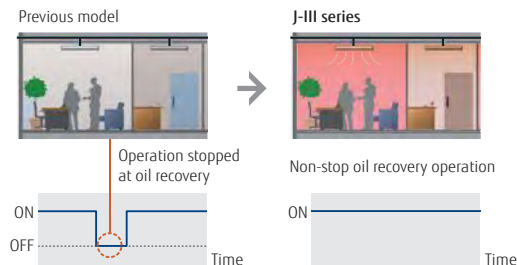

## Easier Installation

**Connection check function** : Possible to confirm whether wiring connection and address setting are correct by a quick check run function.

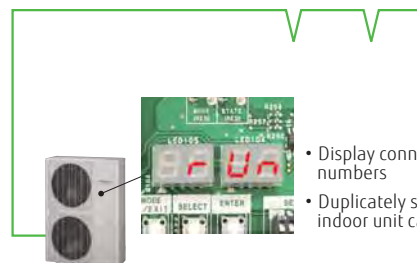

- Display connected indoor unit numbers
- Duplicately set address number of indoor unit can be displayed

4,5,6HP : AJY040LBLAH / AJY045LBLAH / AJY054LBLAH  
 AJY040LELAH [3phase] / AJY045LELAH [3phase] / AJY054LELAH [3phase]



## Specifications

Rating Capacity range		HP	4	5	6
Model name			AJY040LBLAH	AJY045LBLAH	AJY054LBLAH
Maximum Connectable Indoor Unit			1-9	1-10	1-13
Power source			Single-phase, ~230V, 50Hz		
Capacity	Cooling	kW	12.1	14.0	15.5
	Heating		13.6	16.0	18.0
Input power	Cooling	kW	2.90	3.57	4.18
	Heating		2.80	3.55	4.26
EER/SEER (LOT21)	Cooling	W/W	4.17 / 5.99	3.92 / 5.85	3.71 / 5.78
COP/SCOP (LOT21)	Heating	W/W	4.86 / 3.92	4.51 / 3.85	4.23 / 3.78
Airflow rate		m <sup>3</sup> /h	6,200	6,400	6,900
Sound pressure level / Power level	Cooling	dB(A)	50 / 66	51 / 67	53 / 69
	Heating		52 / 68	53 / 69	55 / 71
Minimum Recommended MCB		AMP	32	32	32
Net Dimensions	Height	mm	1,334	1,334	1,334
	Width		970	970	970
	Depth		370	370	370
Weight		kg	117	117	119
Refrigerant	Type		R410A	R410A	R410A
	Charge	kg	4.8	5.3	5.3
Connection pipe diameter	Liquid	Inch	3/8	3/8	3/8
	Gas		5/8	5/8	3/4
Total pipe length		m	180	180	180
Max. height difference			50/40 (Outdoor unit: Upper/Lower)		
Operation range	Cooling	°C	-5 to 46	-5 to 46	-5 to 46
	Heating		-20 to 21	-20 to 21	-20 to 21

Rating Capacity range		HP	4	5	6
Model name			AJY040LELAH	AJY045LELAH	AJY054LELAH
Maximum Connectable Indoor Unit			1-9	1-10	1-13
Power source			3-phase, ~400V, 50Hz		
Capacity	Cooling	kW	12.1	14.0	15.5
	Heating		13.6	16.0	18.0
Input power	Cooling	kW	2.79	3.46	3.99
	Heating		2.71	3.40	4.08
EER/SEER (LOT21)	Cooling	W/W	4.33 / 6.15	4.05 / 5.98	3.88 / 5.97
COP/SCOP (LOT21)	Heating	W/W	5.01 / 4.10	4.70 / 4.04	4.41 / 4.00
Airflow rate		m <sup>3</sup> /h	6,200	6,400	6,900
Sound pressure level / Power level	Cooling	dB(A)	50 / 66	51 / 67	53 / 69
	Heating		52 / 68	53 / 69	55 / 71
Minimum Recommended MCB		AMP	16	16	16
Net Dimensions	Height	mm	1,334	1,334	1,334
	Width		970	970	970
	Depth		370	370	370
Weight		kg	119	119	119
Refrigerant	Type		R410A	R410A	R410A
	Charge	kg	4.8	5.3	5.3
Connection pipe diameter	Liquid	Inch	3/8	3/8	3/8
	Gas		5/8	5/8	3/4
Total pipe length		m	180	180	180
Max. height difference			50/40 (Outdoor unit: Upper/Lower)		
Operation range	Cooling	°C	-5 to 46	-5 to 46	-5 to 46
	Heating		-20 to 21	-20 to 21	-20 to 21

Note: Specifications are based on the following conditions.

Cooling: Indoor temperature of 27°CDB/19°CWB, and outdoor temperature of 35°CDB/24°CWB.

Heating: Indoor temperature of 20°CDB/(15°CWB), and outdoor temperature of 7°CDB/6°CWB.

Pipe length: 7.5 m; Height difference between outdoor unit and indoor unit: 0 m.

The protective function may work when using it outside the operation range.

## Dimensions

(Unit : mm)

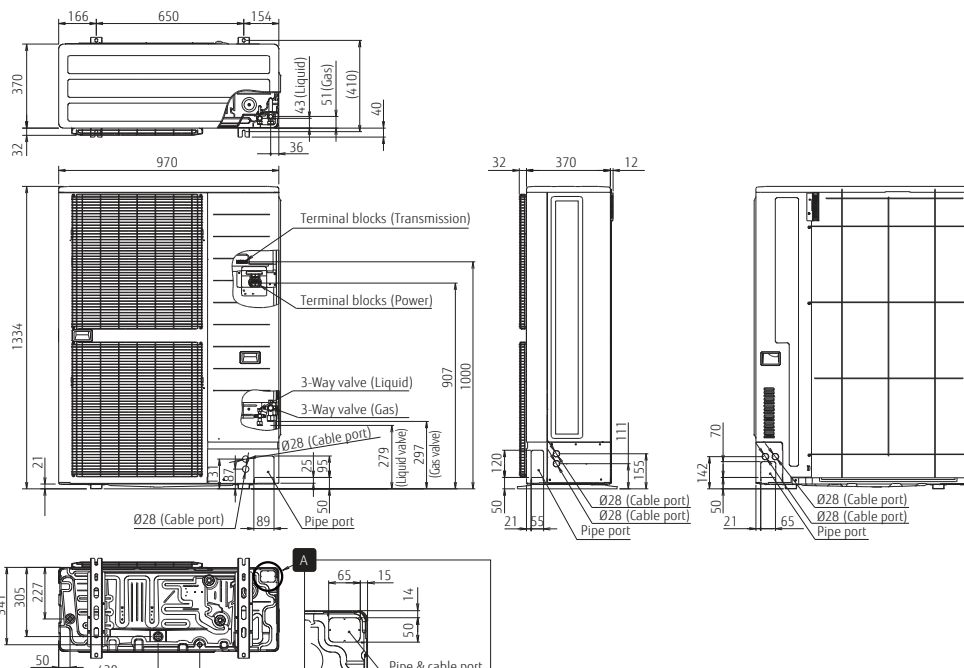

# Heat Pump

for Small Capacity Type

## AIRSTAGE™ J-IV

### Efficiency in actual operation

Top class high COP (Max. Heating) is achieved for all models because of a large heat exchanger, highly efficient DC twin compressor.

#### High EER / COP (Max. Heating)

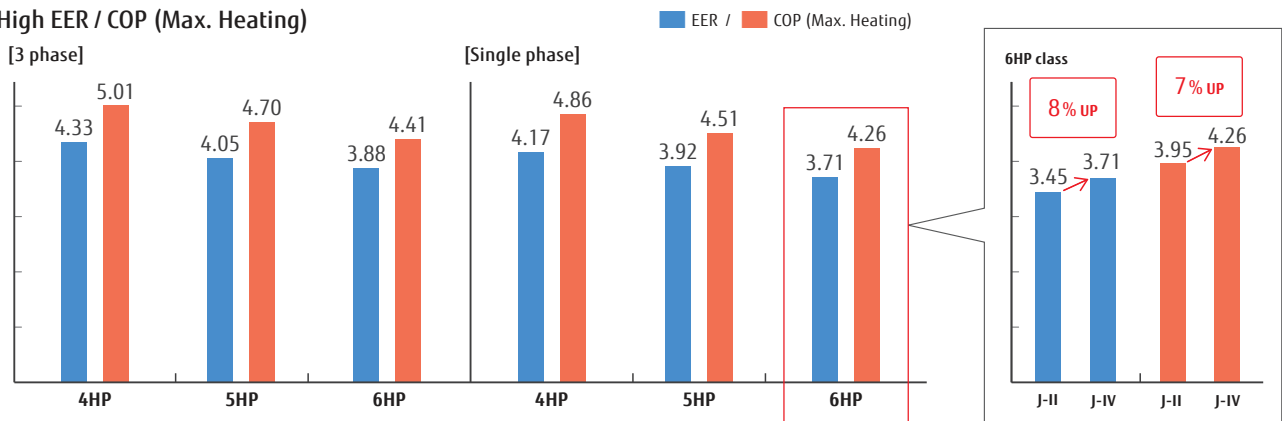

### Long piping length

Our advanced refrigerant control technology allows us to achieve a total refrigerant piping length of 180 m. This opens up new possibilities in system design.

### Up to 14 units\* can be connected

Improvements in the design of the outdoor heat exchanger combined with our new 1.1kW indoor units mean that up to 14 indoor units can be connected.

\*: 6 HP model

Model	Current model (J-III)			New model (J-IV)		
	4	5	6	4	5	6
Rating Capacity range (HP)	4	5	6	4	5	6
Max. Connectable indoor unit	1-9	1-10	1-13	1-11	1-12	1-14

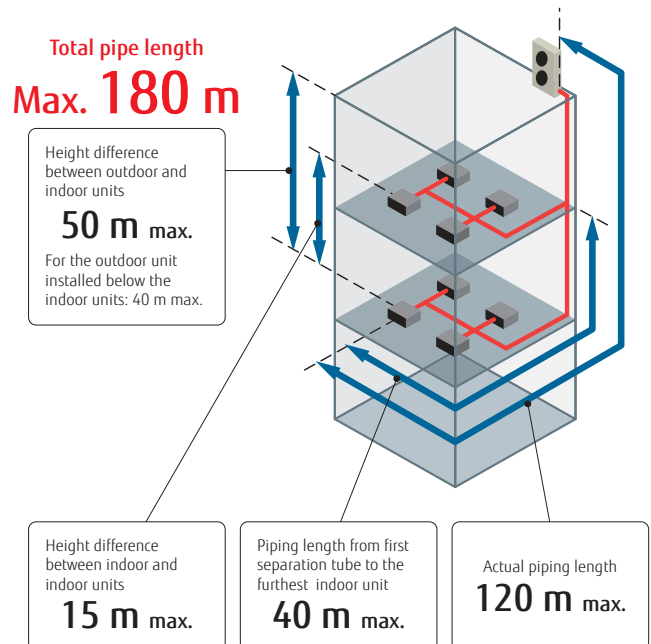

**4,5,6HP : AJY040LBLEBH / AJY045LBLEBH / AJY054LBLEBH**  
**AJY040LELBH [3 phase] / AJY045LELBH [3 phase] / AJY054LELBH [3 phase]**



**NEW**

**Specifications**

Rating Capacity range		HP	4	5	6
Model name			AJY040LBLEBH	AJY045LBLEBH	AJY054LBLEBH
Maximum Connectable Indoor Unit			1-11	1-12	1-14
Power source			Single phase, ~230V, 50Hz		
Capacity	Cooling	kW	12.1	14.0	15.5
	Nominal Heating		12.1	14.0	15.5
	Max Heating		13.6	16.0	18.0
Input power	Cooling	kW	2.90	3.57	4.18
	Nominal Heating		2.39	2.97	3.50
	Max Heating		2.80	3.55	4.26
EER	Cooling		4.17	3.92	3.71
COP	Nominal Heating	W/W	5.06	4.71	4.43
	Max Heating		4.86	4.51	4.23
Airflow rate		m <sup>3</sup> /h	6,200	6,400	6,900
Sound pressure level / Power level	Cooling	dB(A)	50 / 65	51 / 65	53 / 66
	Heating		52 / 67	55 / 69	56 / 69
Heat exchanger fin			Blue fin	Blue fin	Blue fin
Net Dimensions	Height	mm	1,334	1,334	1,334
	Width		970	970	970
	Depth		370	370	370
Weight		kg	117	117	119
Refrigerant	Type (Global Warming Potential)		R410A (2,088)	R410A (2,088)	R410A (2,088)
	Charge	kg(CO <sub>2</sub> eq-T)	4.8 (10.0)	5.3 (11.1)	5.3 (11.1)
Connection pipe diameter	Liquid	mm	9.52	9.52	9.52
	Gas		15.88	15.88	19.05
Total pipe length		m	180	180	180
Max. height difference			50/40 (Outdoor unit: Upper/Lower)		
Operation range	Cooling	°C	-5 to 46	-5 to 46	-5 to 46
	Heating		-20 to 21	-20 to 21	-20 to 21

Rating Capacity range		HP	4	5	6
Model name			AJY040LELBH	AJY045LELBH	AJY054LELBH
Maximum Connectable Indoor Unit			1-11	1-12	1-14
Power source			3 phase, ~400V, 50Hz		
Capacity	Cooling	kW	12.1	14.0	15.5
	Nominal Heating		12.1	14.0	15.5
	Max Heating		13.6	16.0	18.0
Input power	Cooling	kW	2.79	3.46	3.99
	Nominal Heating		2.32	2.86	3.36
	Max Heating		2.71	3.40	4.08
EER	Cooling		4.33	4.05	3.88
COP	Nominal Heating	W/W	5.21	4.90	4.61
	Max Heating		5.01	4.70	4.41
Airflow rate		m <sup>3</sup> /h	6,200	6,400	6,900
Sound pressure level / Power level	Cooling	dB(A)	50 / 65	51 / 65	53 / 66
	Heating		52 / 67	55 / 69	56 / 69
Heat exchanger fin			Blue fin	Blue fin	Blue fin
Net Dimensions	Height	mm	1,334	1,334	1,334
	Width		970	970	970
	Depth		370	370	370
Weight		kg	118	119	119
Refrigerant	Type (Global Warming Potential)		R410A (2,088)	R410A (2,088)	R410A (2,088)
	Charge	kg(CO <sub>2</sub> eq-T)	4.8 (10.0)	5.3 (11.1)	5.3 (11.1)
Connection pipe diameter	Liquid	mm	9.52	9.52	9.52
	Gas		15.88	15.88	19.05
Total pipe length		m	180	180	180
Max. height difference			50/40 (Outdoor unit: Upper/Lower)		
Operation range	Cooling	°C	-5 to 46	-5 to 46	-5 to 46
	Heating		-20 to 21	-20 to 21	-20 to 21

Note: Specifications are based on the following conditions.

Cooling: Indoor temperature of 27°CDB/19°CWB, and outdoor temperature of 35°CDB/24°CWB.

Heating: Indoor temperature of 20°CDB/(15°CWB), and outdoor temperature of 7°CDB/6°CWB.

Pipe length: 7.5 m; Height difference between outdoor unit and indoor unit: 0 m.

The protective function may work when using it outside the operation range.

**Dimensions**

(Unit : mm)

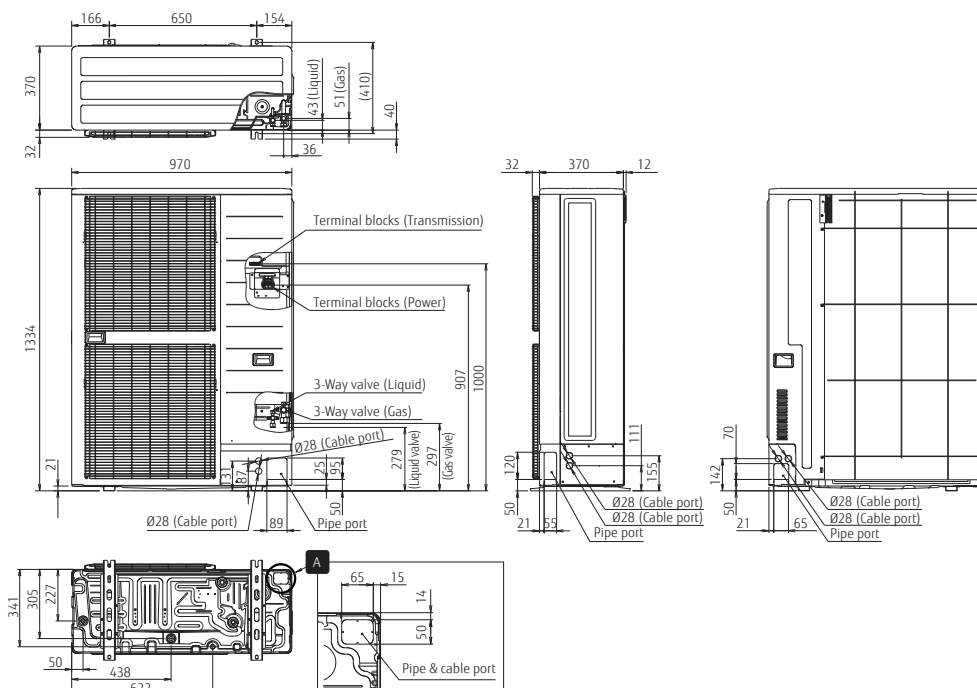

# Heat Pump for Small Capacity Type

**AIRSTAGE J-III L**



## Long Piping Length

Our advanced refrigerant control technology allows us to achieve a total refrigerant piping length of 400 m. This opens up new possibilities in system design.

## Up to 40 units\* can be connected

Improvements in the design of the outdoor heat exchanger combined with our new 1.1kW indoor units mean that up to 40 indoor units can be connected.

\*: 16 HP model.

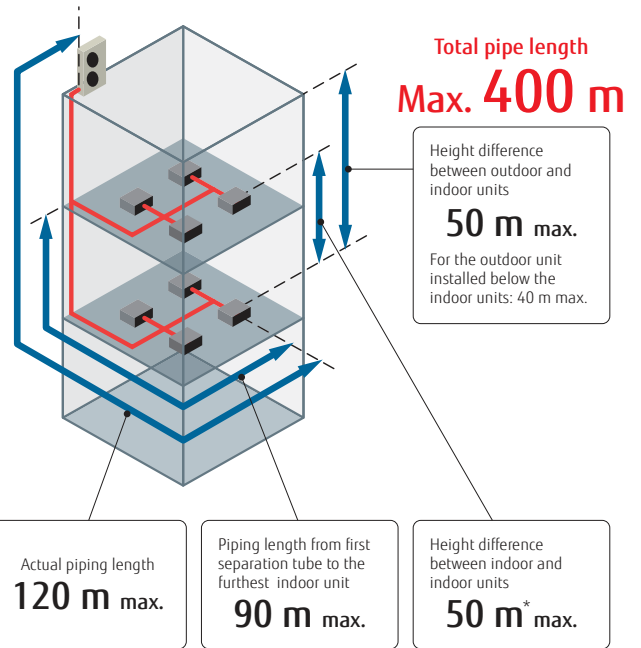

\*: Only when new indoor units and J-III L series are combined

## High Static Pressure

External static pressure is available up to 60Pa for 14/16HP. (20Pa for 8/10HP, 30Pa for 12HP)



## Top Class Low Operating Sound

Low operating noise level make the units suitable for locations where sound levels are important.

Sound Power Level

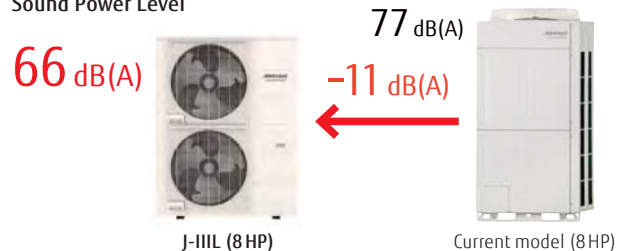

**8,10,12HP: AJY072LELAH / AJY090LELAH / AJY108LELAH**  
**14,16,18HP: AJY126LELAH / AJY144LELAH / AJY162LELAH**



8, 10, 12 HP

14, 16, 18 HP

## Specifications

Rating Capacity range		HP	8	10	12	14	16	18
Model name			AJY072LELAH	AJY090LELAH	AJY108LELAH	AJY126LELAH	AJY144LELAH	AJY162LELAH
Maximum Connectable Indoor Unit			1-20	1-25	1-30	1-36	1-40	1-42
Power source			3 phase, ~400V, 50Hz					
Capacity	Cooling	kW	22.4	28.0	33.5	40.0	45.0	50.0
	Nominal Heating		22.4	28.0	33.5	40.0	45.0	50.0
	Max Heating		25.0	31.5	37.5	45.0	50.0	55.0
Input power	Cooling	kW	6.30	8.59	10.42	12.12	14.96	18.52
	Nominal Heating		4.65	6.61	8.18	9.71	11.81	13.66
	Max Heating		5.45	8.29	10.25	11.82	14.29	16.66
EER/SEER (LOT21)	Cooling	W/W	3.56/6.72	3.26/6.48	3.22/6.72	3.30/6.33	3.01/6.16	2.70
	Nominal Heating		4.82	4.24	4.10	4.12	3.81	3.66
COP/SCOP (LOT21)	Cooling	W/W	4.56/3.86	3.80/3.59	3.66/3.58	3.81/3.52	3.50/3.51	3.30
	Max Heating		4.56/3.86	3.80/3.59	3.66/3.58	3.81/3.52	3.50/3.51	3.30
Airflow rate		m <sup>3</sup> /h	8,400	9,000	11,000	13,000	14,000	14,800
Sound pressure level / Power level	Cooling	dB(A)	52/66	54/69	59/73	62/75	64/77	65/79
	Heating		54/-	57/-	61/-	63/-	65/-	68/-
Minimum Recommended MCB		AMP	20	20	25	40	40	40
Net Dimensions	Height	mm	1,428	1,428	1,428	1,638	1,638	1,638
	Width		1,080	1,080	1,080	1,080	1,080	1,080
	Depth		480	480	480	480	480	480
Weight		kg	170	177	178	210	210	217
Refrigerant	Type		R410A	R410A	R410A	R410A	R410A	R410A
	Charge	kg	7.0	7.5	7.5	11.0	11.0	11.8
Connection pipe diameter	Liquid	Inch	3/8	3/8	1/2	1/2	1/2	1/2
	Gas		3/4	7/8	1 1/8	1 1/8	1 1/8	1 1/8
Total pipe length		m	400	400	400	400	400	400
Max. height difference			50/40 (Outdoor unit: Upper/Lower)					
Operation range	Cooling	°C	-5 to 46*	-5 to 46*	-5 to 46*	-5 to 46*	-5 to 46*	-5 to 46*
	Heating		-20 to 21	-20 to 21	-20 to 21	-20 to 21	-20 to 21	-20 to 21

Note: Specifications are based on the following conditions.

Cooling: Indoor temperature of 27°CDB / 19°CWB, and outdoor temperature of 35°CDB / 24°CWB.

Heating: Indoor temperature of 20°CDB / (15°CWB), and outdoor temperature of 7°CDB / 6°CWB.

Pipe length: 7.5 m; Height difference between outdoor unit and indoor unit: 0 m.

\* The cooling operation range of -15 to 46°C is allowed only when all of the indoor units connected to the system are higher than capacity of 5.6kW.

## Dimensions

(Unit : mm)

### 8, 10, 12 HP

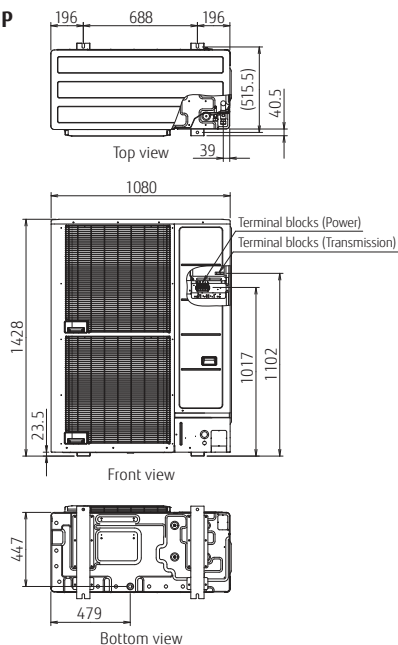

### 14, 16 18 HP

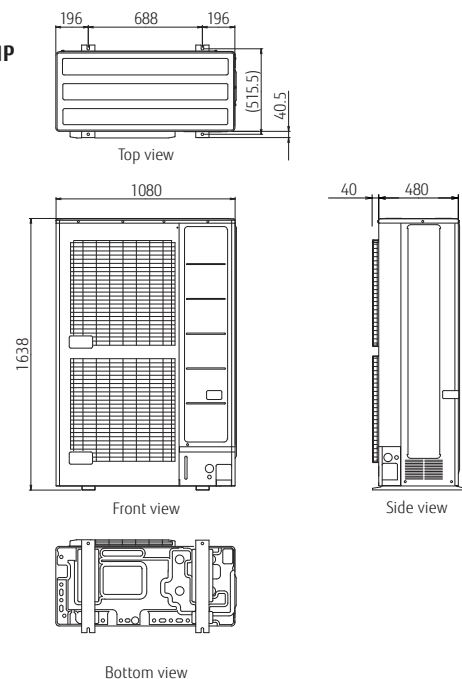

# Heat Pump

for Small Capacity Type

## AIRSTAGE™ J-IVL

### Efficiency in actual operation

Top class high EER/COP(Max. Heating) is achieved for all models by a large heat exchanger, highly efficient Scroll compressor.

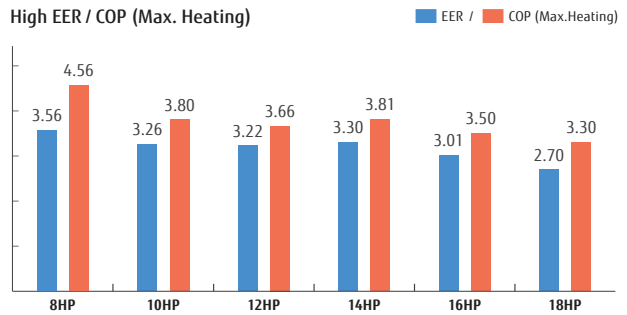

### Long piping length

Our advanced refrigerant control technology allows us to achieve a total refrigerant piping length of 400 m. This opens up new possibilities in system design.

### Up to 42 units\* can be connected

Improvements in the design of the outdoor heat exchanger combined with our new 1.1kW indoor units mean that up to 42 indoor units can be connected.

\*: 18 HP model

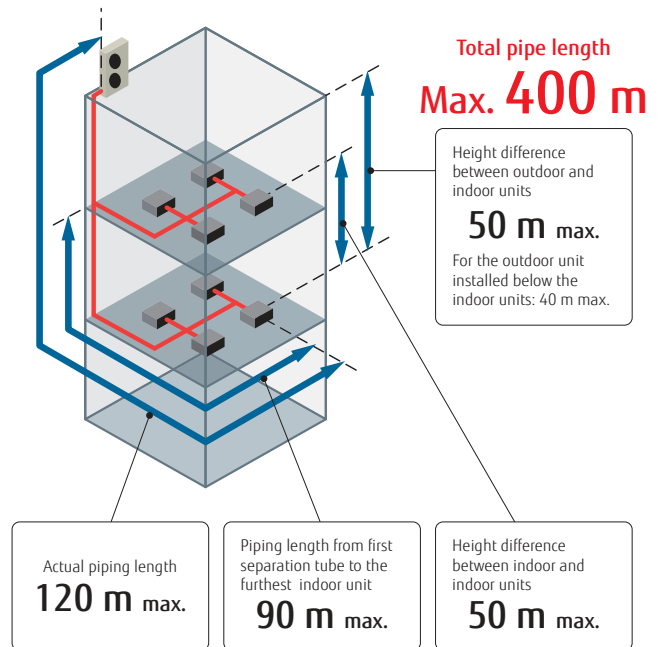

### Top Class Low Operating Sound

Low operating noise level make the units suitable for locations where sound levels are important.

Sound Power Level

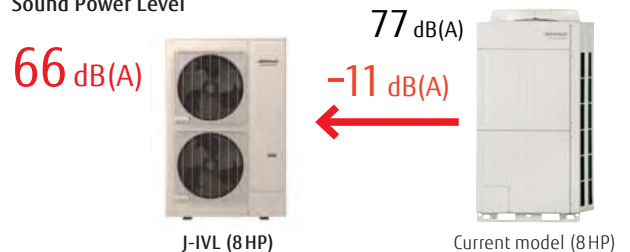



8,10,12 HP: AJY072LELBH / AJY090LELBH / AJY108LELBH  
 14,16,18 HP: AJY126LELBH / AJY144LELBH / AJY162LELBH



## Specifications

Rating Capacity range		HP	8	10	12	14	16	18
Model name			AJY072LELBH	AJY090LELBH	AJY108LELBH	AJY126LELBH	AJY144LELBH	AJY162LELBH
Maximum Connectable Indoor Unit			1-20	1-25	1-30	1-36	1-40	1-42
Power source			3 phase, ~400V, 50Hz					
Capacity	Cooling	kW	22.4	28.0	33.5	40.0	45.0	50.0
	Nominal Heating		22.4	28.0	33.5	40.0	45.0	50.0
	Max Heating		25.0	31.5	37.5	45.0	50.0	55.0
Input power	Cooling	kW	6.30	8.59	10.42	12.12	14.96	18.52
	Nominal Heating		4.65	6.61	8.18	9.71	11.81	13.66
	Max Heating		5.45	8.29	10.25	11.80	14.29	16.66
EER	Cooling		3.56	3.26	3.22	3.30	3.01	2.70
COP	Nominal Heating	W/W	4.82	4.24	4.10	4.12	3.81	3.66
	Max Heating		4.56	3.80	3.66	3.81	3.50	3.30
Airflow rate		m <sup>3</sup> /h	8,400	9,000	11,000/12,100	13,000	14,000	14,800/15,300
Sound pressure level / Power level	Cooling	dB(A)	52/66	54/69	59/73	62/75	64/77	65/79
	Heating		54/-	57/-	62/-	63/-	65/-	68/-
Net Dimensions	Height	mm	1,428	1,428	1,428	1,638	1,638	1,638
	Width		1,080	1,080	1,080	1,080	1,080	1,080
	Depth		480	480	480	480	480	480
Weight		kg	170	177	178	213	213	217
Refrigerant	Type (Global Warming Potential)		R410A (2,088)	R410A (2,088)	R410A (2,088)	R410A (2,088)	R410A (2,088)	R410A (2,088)
	Charge	kg(CO <sub>2</sub> eq-T)	7.0 (14.6)	7.5 (15.7)	7.5 (15.7)	11.0 (22.9)	11.0 (22.9)	11.8 (24.6)
Connection pipe diameter	Liquid	mm	9.52	9.52	12.70	12.70	12.70	12.70
	Gas		19.05	22.20	28.58	28.58	28.58	28.58
Total pipe length		m	400	400	400	400	400	400
Max. height difference			50/40 (Outdoor unit: Upper/Lower)					
Operation range	Cooling	°C	-15 to 46	-15 to 46	-15 to 46	-5 to 46*	-5 to 46*	-5 to 46*
	Heating		-20 to 21	-20 to 21	-20 to 21	-20 to 21	-20 to 21	-20 to 21

Note: Specifications are based on the following conditions.

Cooling: Indoor temperature of 27°CDB / 19°CWB, and outdoor temperature of 35°CDB / 24°CWB.

Heating: Indoor temperature of 20°CDB / (15°CWB), and outdoor temperature of 7°CDB / 6°CWB.

Pipe length: 7.5 m; Height difference between outdoor unit and indoor unit: 0 m.

\* The cooling operation range of -15 to 46°C is allowed only when all of the indoor units connected to the system are higher than capacity of 5.6kW.

## Dimensions

(Unit : mm)

### 8, 10, 12 HP

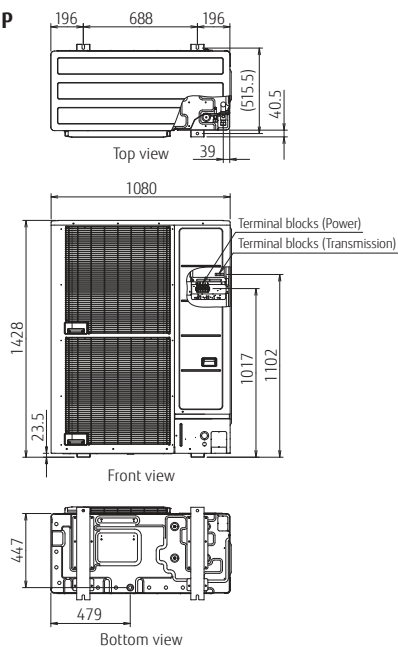

### 14, 16, 18 HP

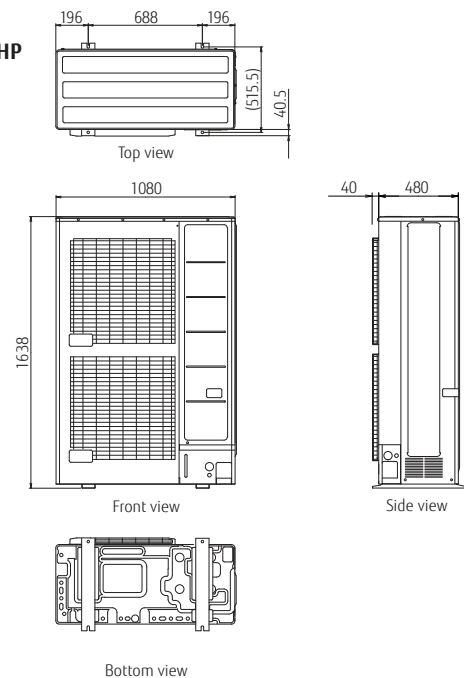

# AIRSTAGE™ V Series Overview

AIRSTAGE™ V Series Systems can be designed to effectively provide an air conditioning solution from a large domestic residence through to a large scale commercial building.



**NEW** Max. **48 HP** Heat Recovery  
**AIRSTAGE™ VR-IV**

Smart and cutting-edge design.  
 Extensive lineup from 8 HP to 48 HP in 2 HP increment.  
 Connectable indoor unit capacity ratio up to 150%

**Simultaneous cooling and heating operation using 1 refrigerant system**

Cooling and heating can be freely selected for each indoor unit to provide simultaneous cooling and heating in rooms with different temperature requirements.

**Annual cooling operation**

Use annual cooling operation for the rooms and other spaces that require constant temperature control throughout the year.

**Handles changes in the temperature difference**

The operation mode can be freely changed when there are large temperature differences during the day, such as between seasons.



Max. **54 HP** Heat Pump  
**AIRSTAGE™ V-III**

Smart and cutting-edge design.  
 Extensive lineup from 8 HP to 54 HP in 2 HP increment.  
 Connectable indoor unit capacity ratio up to 150%

**Excellent energy saving**

Heat pump inverter type achieves high energy savings for individual cooling and heating operation by all inverter technology for seasonal efficiency.

**High design flexibility for various building air conditioning**

High design flexibly meets the various needs of high-rise building air conditioning such as outdoor unit roof top concentrated installation and each floor installation by large capacity combination, sufficient connection capacity, and high static pressure design.

**Easy installation and maintenance**

The flexible communication method and piping connections make installation and maintenance easy even for large systems.

# Heat Recovery Modular Type

**AIRSTAGE VR-II**



## High Operating Energy Efficiency

Our Heat recovery systems achieve high operating energy efficiency by drawing heat from the room to be cooled and transferring it as energy for rooms that are to be heated.

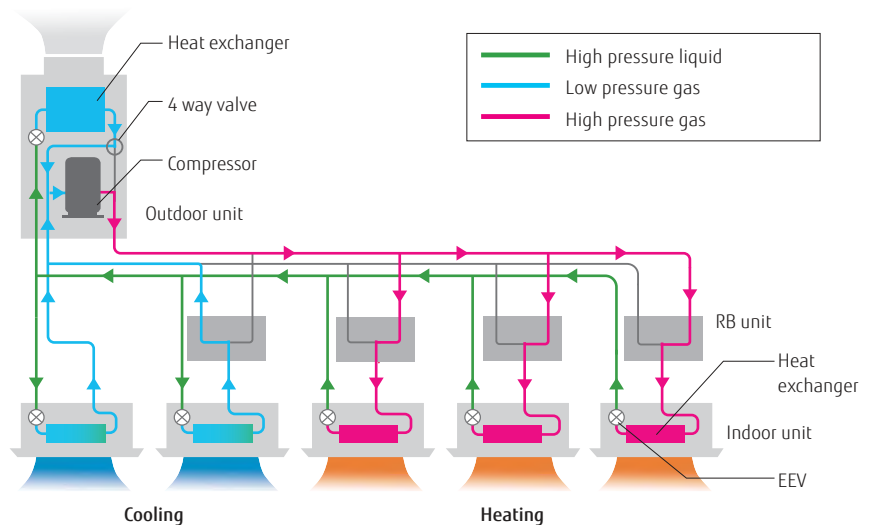

Space saving combination (COP)

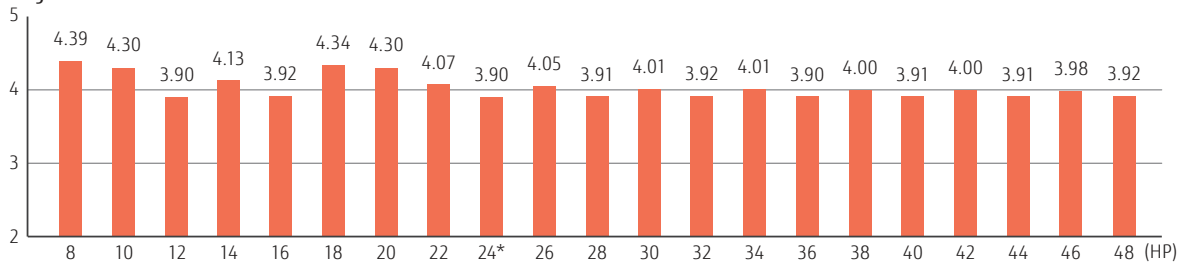

Energy efficiency combination (COP)

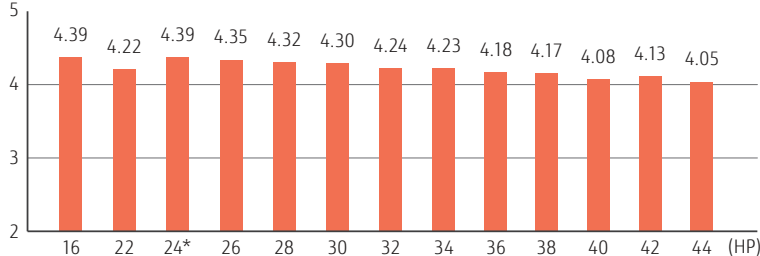

For 24HP Combination



**COP 12.6% UP**

8,10,12HP : AJYA72GALH / AJYA90GALH / AJY108GALH  
 14,16HP : AJY126GALH / AJY144GALH



8, 10, 12 HP

14, 16 HP

## Dimensions

(Unit : mm)

### 8, 10, 12 HP

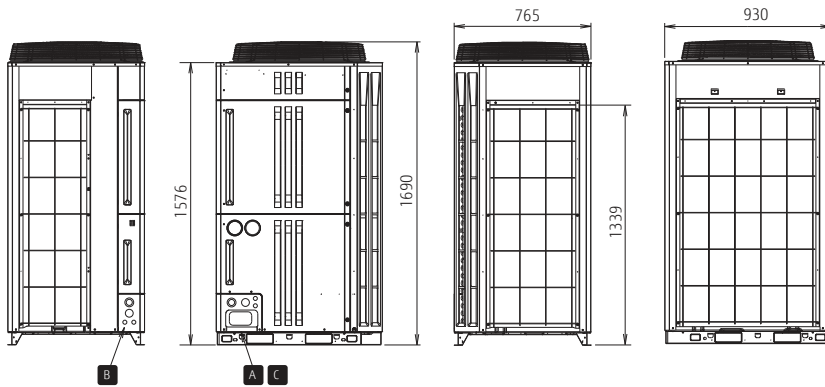
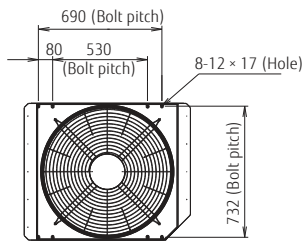

### 14, 16 HP

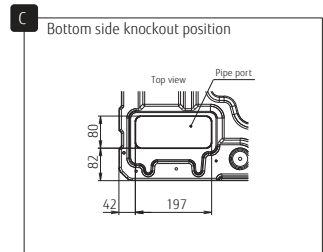
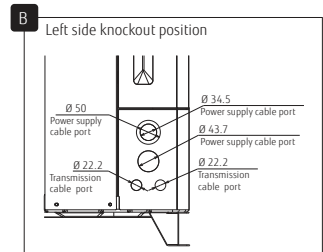
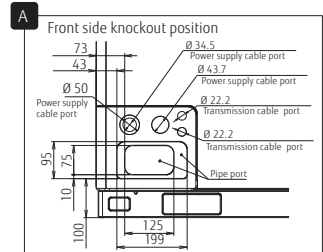
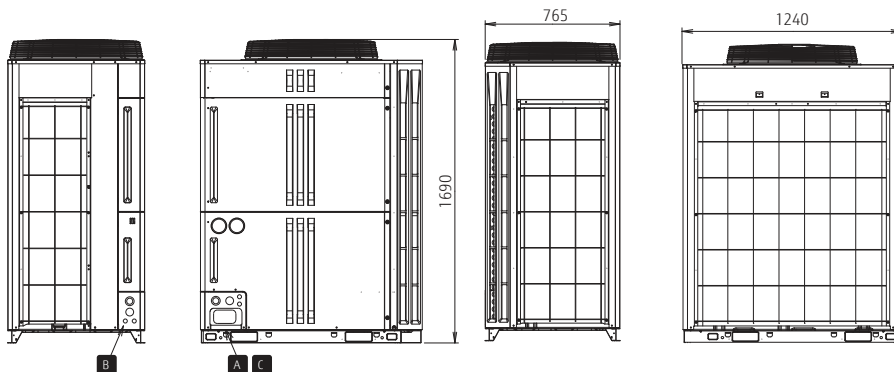
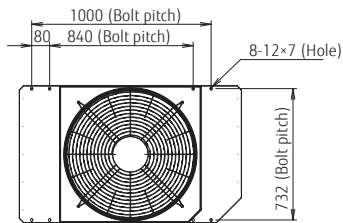





# Heat Recovery

Modular Type

## AIRSTAGE™ VR-IV

### Flexible piping connection

Flexible refrigerant piping work is possible by the use of various piping and RB Unit connections, allowing for adjustments to the floor layout and building structure.

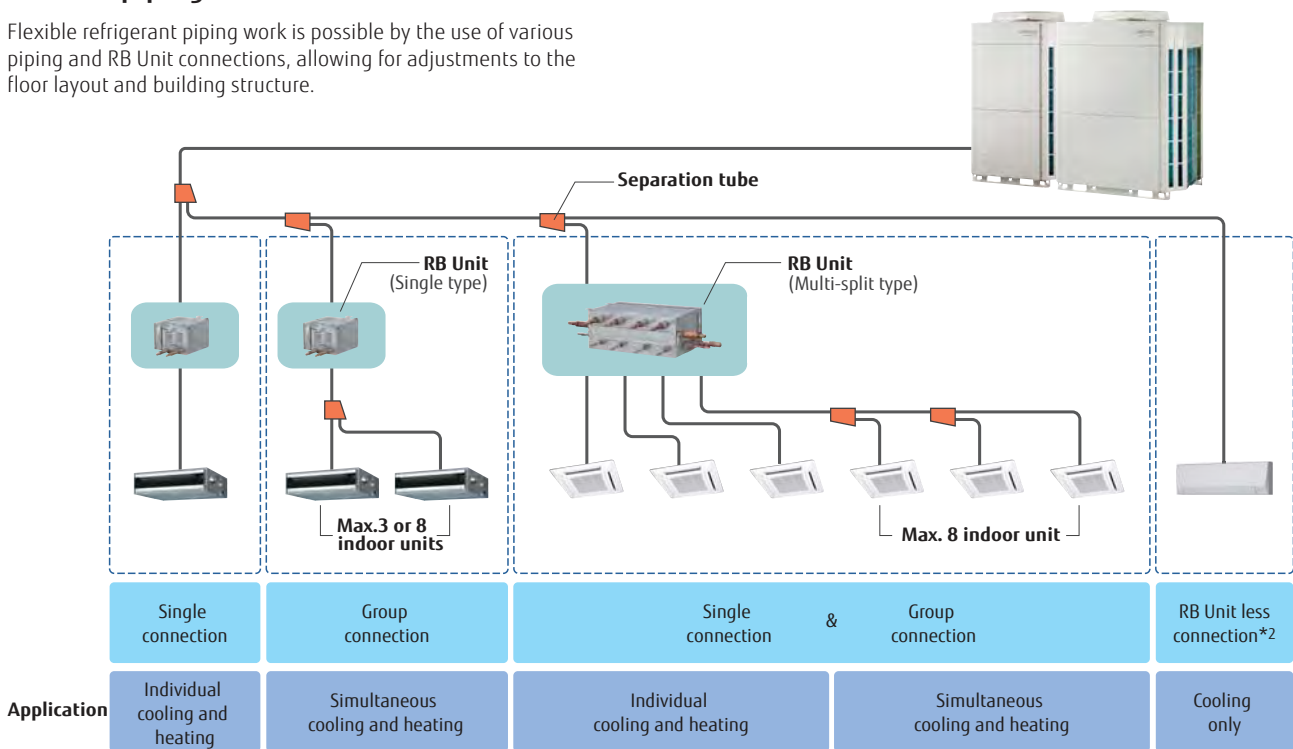

• The RB unit can be freely positioned between the first branch and the indoor unit.  
 • The maximum height difference between RB units is 15 m.  
 \*2. RB Unit is not necessary for cooling only use.



8,10,12HP : AJY072GALBH / AJY090GALBH / AJY108GALBH  
 14,16HP : AJY126GALBH / AJY144GALBH



8, 10, 12 HP

14, 16 HP

**Dimensions**

(Unit : mm)

**8, 10, 12 HP**

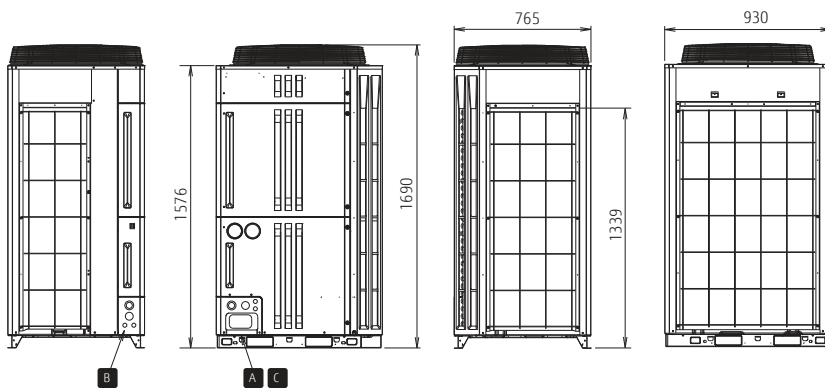
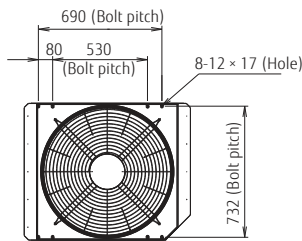

**14, 16 HP**

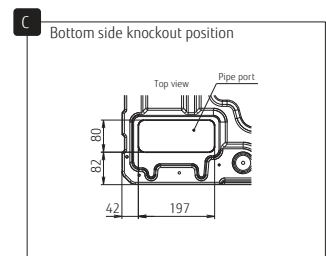
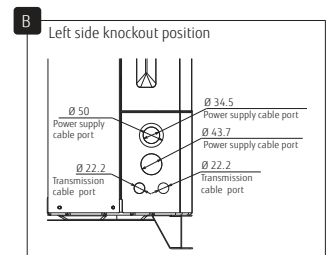
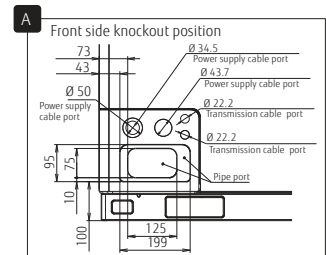
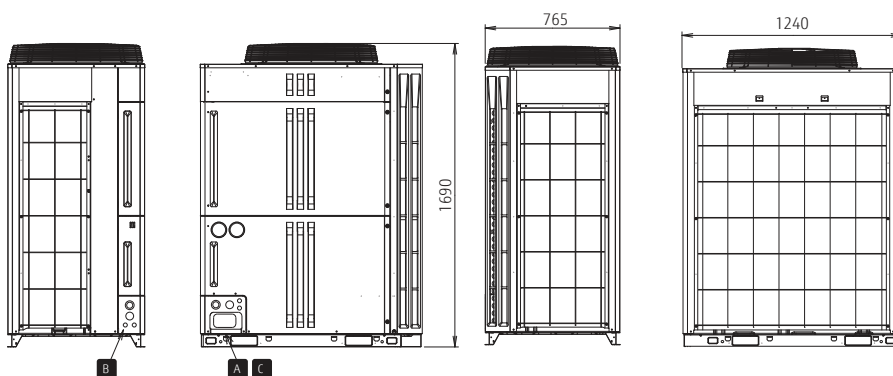
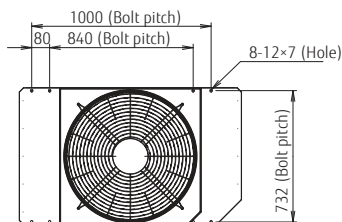





# Heat Pump Modular Type

AIRSTAGE V-III



## Efficiency in actual operation

Top class high COP is achieved for all combinations by our unique heat exchanger structure, highly efficient DC twin compressor.

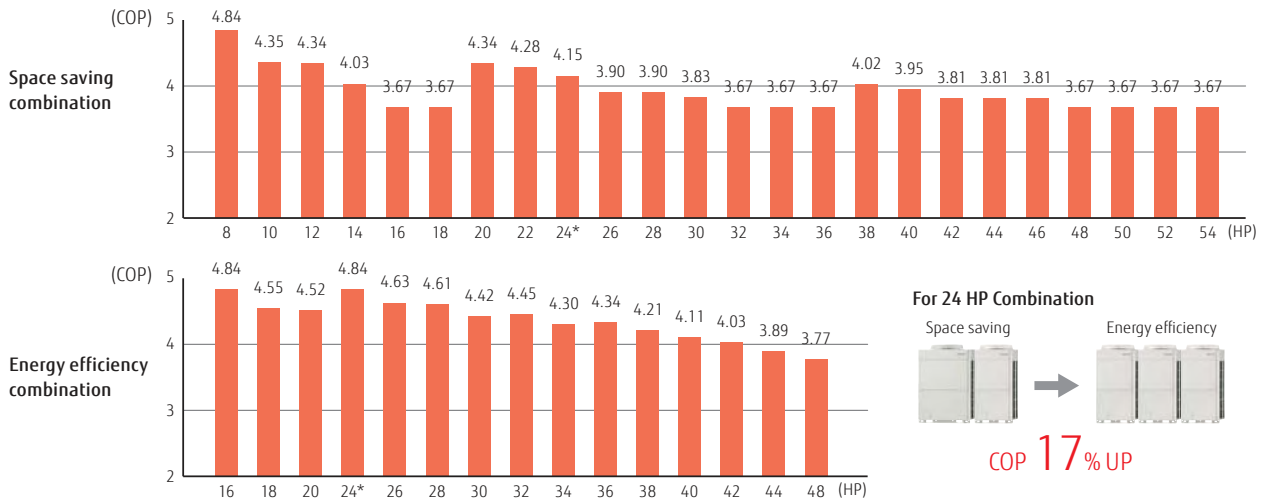

## System configuration example

- This system is used for medium-sized and large buildings. Connecting each outdoor unit makes it possible to create a high capacity system.
- Connection of multiple indoor units using separation tubes and headers.

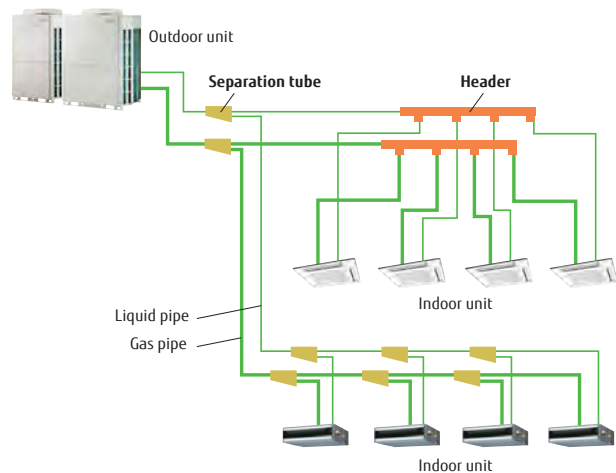

8,10HP: AJY072LALBH / AJY090LALBH  
 12,14,16,18HP: AJY108LALBH / AJY126LALBH / AJY144LALBH / AJY162LALBH



8, 10 HP



12, 14, 16, 18 HP

**Dimensions**

(Unit : mm)

**8, 10 HP**

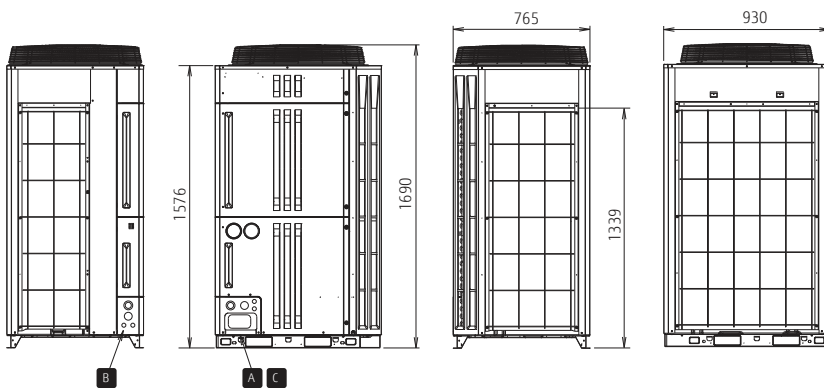
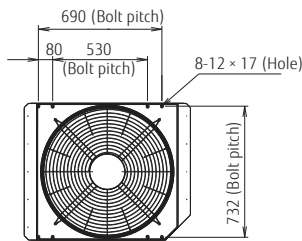



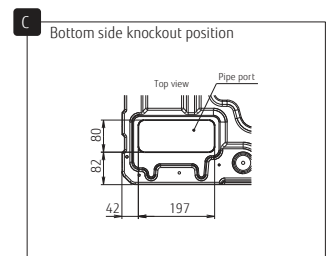
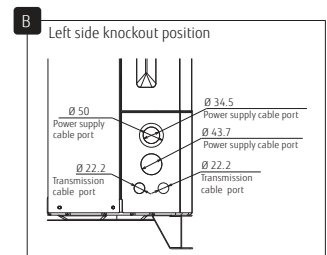
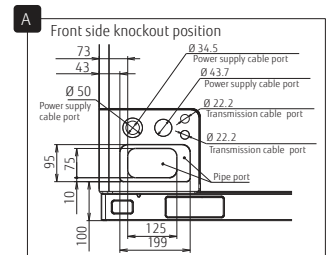
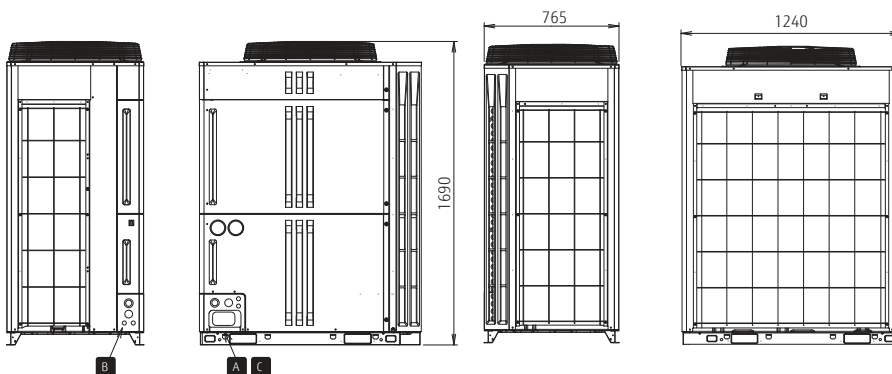
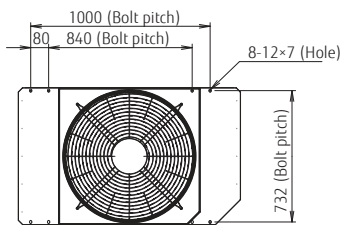



















































**12, 14, 16, 18 HP**







# VRF Indoor Unit Lineup

Capacity range (kW)			1.1	2.2	2.8	3.6			
Class			4	7	9	12			
Cassette	Compact type	Compact Grid type / Standard type	 AUXB 004 GLEH	 AUXB 007 GLEH	 AUXB 009 GLEH	 AUXB 012 GLEH			
	Large type	Circular Flow							
Duct	Low Static Pressure Duct	Mini Duct (With drain pump)	 004 - 014	 018	 ARXK 004 GLGH	 ARXK 007 GLGH	 ARXK 009 GLGH	 ARXK 012 GLGH	
		Slim Duct (With drain pump)	 04 / 007 - 014	 018	 024	 ARXD 04 GALH*3	 ARXD 007 GLEH	 ARXD 009 GLEH	 ARXD 012 GLEH
	Medium Static Pressure Duct	Normal							
	High Static Pressure Duct	Normal	 036 / 45 - 60	 072 - 090	 096				
Floor	Floor (*Same as Ceiling models)					 ABYA 012 GTEH			
	Slim Concealed Floor (*Same as Slim Duct models)	 04 / 007 - 014	 018	 024	 ARXD 04 GALH*3	 ARXD 007 GLEH	 ARXD 009 GLEH	 ARXD 012 GLEH	
	Compact Floor				 AGYA 004 GCGH	 AGYA 007 GCGH	 AGYA 009 GCGH	 AGYA 012 GCGH	
	Compact Floor (EEV external)				 AGYE 004 GCEH	 AGYE 007 GCEH	 AGYE 009 GCEH	 AGYE 012 GCEH	
			With this model, connection of EV kit is necessary.						
Ceiling		 012 - 024	 030 - 054			 ABYA 012 GTEH			
Wall Mounted	Wall Mounted	 004 - 009	 012 - 014	 18 - 24	 030 - 034	 ASYA 004 GTEH	 ASYA 007 GTEH	 ASYA 009 GTEH	 ASYA 012 GCEH
	Wall Mounted (EEV external)	 004 - 009	 012 - 014			 ASYE 004 GTEH	 ASYE 007 GTEH	 ASYE 009 GTEH	 ASYE 012 GCEH
			With this model, connection of EV kit is necessary.						



	4.0	4.5	5.6	7.1	9.0	10.0	11.2	12.5	14.0	18.0	22.4	25.0	28.0
	14	14	18	24	30	34	36	45	54	60	72	90	96
		AUXB 014 GLEH	AUXB 018 GLEH	AUXB 024 GLEH									
			AUXK 018 GLEH	AUXK 024 GLEH	AUXK 030 GLEH	AUXK 034 GLEH	AUXK 036 GLEH	AUXK 045 GLEH	AUXK 054 GLEH				
		ARXD 014 GLEH	ARXD 018 GLEH	ARXD 024 GLEH									
				ARXA 024 GLEH	ARXA 030 GLEH		ARXA 036 GLEH	ARXA 045 GLEH					
							ARXC 036 GTEH	ARXC 45 GATH		ARXC 60 GATH*1	ARXC 072 GTEH*1	ARXC 090 GTEH*1	ARXC 096 GTEH*1
		ABYA 014 GTEH	ABYA 018 GTEH	ABYA 024 GTEH									
		ARXD 014 GLEH	ARXD 018 GLEH	ARXD 024 GLEH									
AGYA 014 GCCG													
AGYE 014 GCEH													
		ABYA 014 GTEH	ABYA 018 GTEH	ABYA 024 GTEH	ABYA 030 GTEH		ABYA 036 GTEH	ABYA 045 GTEH	ABYA 054 GTEH				
ASYA 014 GCEH			ASYA 18 GBCH	ASYA 24 GBCH	ASYA 030 GTEH	ASYA 034 GTEH							
ASYE 014 GCEH													

\*1: ARXC60/072/090/096G cannot be connected to J-IVS / J-IV Series.

\*2: AUXA18/24GALH, ARX0018/024/030GTAH type can be connected to VR-IV / V-III Series only.

\*3: ARXD04GALH cannot be connected to J-IVS / J-IV / J-IVL Series.

\*4: AUXN009/012/014GLAH can be connected to J-IVS / J-IV Series only.

\*5: ARXP009/012/014GLAH can be connected to J-IVS / J-IV / J-IVL Series only.

\*6: Production by order

Specifications and design are subject to change without notice.

Model : AUXB004GLEH / AUXB007GLEH / AUXB009GLEH  
 AUXB012GLEH / AUXB014GLEH / AUXB018GLEH  
 AUXB024GLEH

# Compact Cassette Grid type



## Specifications

Model name		AUXB004GLEH	AUXB007GLEH	AUXB009GLEH	AUXB012GLEH	AUXB014GLEH	AUXB018GLEH	AUXB024GLEH
Power source		Single phase, ~230V, 50Hz						
Capacity	UK Total Cooling	0.80	1.60	2.10	2.70	3.30	4.20	5.30
	UK Sensible Cooling	0.70	1.50	1.70	2.30	2.70	3.20	4.40
	UK Heating	1.20	2.60	3.00	3.80	4.70	5.90	7.40
	Nominal Cooling	1.10	2.20	2.80	3.60	4.50	5.60	7.10
	Nominal Heating	1.30	2.80	3.20	4.10	5.00	6.30	8.00
Input power	W	23	25	25	29	35	36	84
Airflow rate	High	530/530	540	550	600	680	710	1,030
	Med-H	490/480	500	520	560	620	660	910
	Med	450/430	460	480	520	560	590	790
	Med-L	420/380	420	440	480	500	520	680
	Low	390/340	390	400	430	440	460	560
	Quiet	350/300	350	350	390	390	400	450
Sound pressure level	High	34/34	34	35	37	38	41	50
	Med-H	32/31	32	33	34	37	39	46
	Med	30/29	30	31	33	34	36	43
	Med-L	28/26	28	29	31	32	33	39
	Low	27/24	27	27	29	30	30	35
	Quiet	25/21	25	25	27	27	27	30
Net Dimensions (H × W × D)	mm	245 × 570 × 570	245 × 570 × 570	245 × 570 × 570	245 × 570 × 570	245 × 570 × 570	245 × 570 × 570	245 × 570 × 570
Weight	kg(lbs)	14.5 (32)	15 (33)	15 (33)	15 (33)	15 (33)	17 (37)	17 (37)
Connection pipe diameter	Liquid (Flare)	1/4					3/8	
	Gas (Flare)	1/2					5/8	
Cassette Grille	Model name	UTG-UFYE-W						
	Net Dimensions (H×W×D)	mm 50 × 620 × 620						
	Weight	kg(lbs) 2.3(5.1)						

Note : Specifications are based on the following conditions.  
 Cooling : Indoor temperature of 27°CDB / 19°CWB, and outdoor temperature of 35°CDB / 24°CWB.  
 Heating : Indoor temperature of 20°CDB / (15°CWB), and outdoor temperature of 7°CDB / 6°CWB.  
 Pipe length : 7.5 m; Height difference between outdoor unit and indoor unit : 0 m. Voltage : 230 [V].  
 \*1: This value is under cooling operation.

## Optional parts

Fresh Air Intake Kit: UTZ-VXAA      Cassette Grille: UTG-UFYC-W, UTG-UFYE-W  
 External Power Supply Unit: UTZ-GXXA  
 Wireless LAN Interface: UTY-TFSXZ1

Wireless interface for use with Smart home products: FJ-AC-WIFI-1

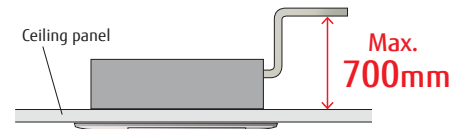

## Dimensions

(Unit : mm)

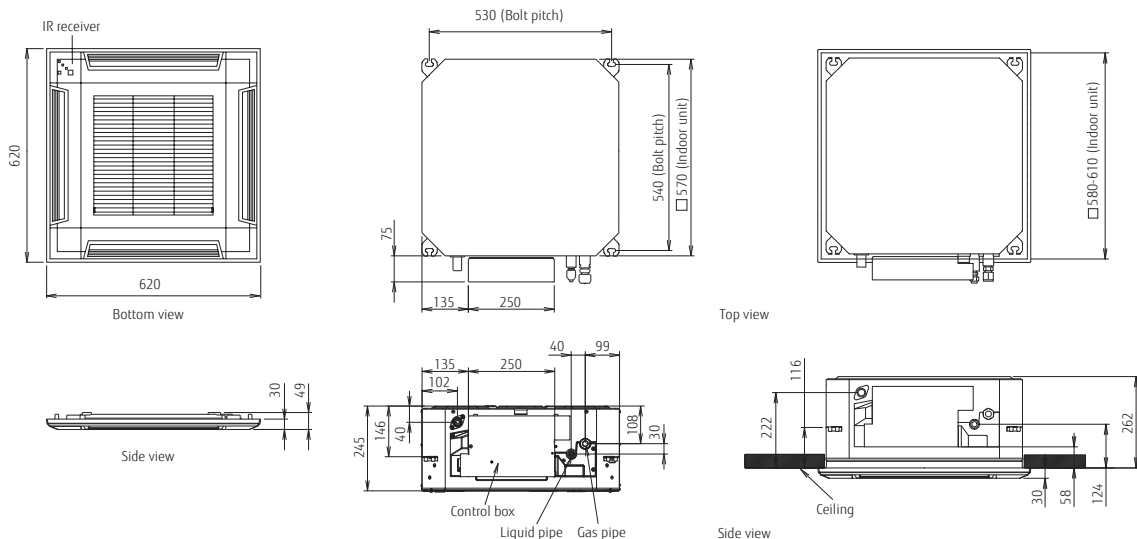

Model : AUXK018GLEH / AUXK024GLEH / AUXK030GLEH  
 AUXK034GLEH / AUXK036GLEH / AUXK045GLEH  
 AUXK054GLEH

# Cassette Large type Circular Flow



## Specifications

Model name		AUXK018GLEH	AUXK024GLEH	AUXK030GLEH	AUXK034GLEH	AUXK036GLEH	AUXK045GLEH	AUXK054GLEH	
Power source		Single phase, ~230V, 50Hz							
Capacity	UK Total Cooling	kW	4.20	5.30	6.70	7.40	8.30	9.30	10.40
	UK Sensible Cooling		3.30	4.40	5.30	5.90	6.70	7.60	8.70
	UK Heating		5.90	7.40	9.30	10.40	11.60	13.00	14.90
	Nominal Cooling		5.60	7.10	9.00	10.00	11.20	12.50	14.00
	Nominal Heating		6.30	8.00	10.00	11.20	12.50	14.00	16.00
Input power		W	40	40	47	47	61	89	116
Airflow rate	High	m <sup>3</sup> /h	1,420	1,420	1,440	1,440	1,620	1,820	2,040
	Med-H		1,360	1,360	1,400	1,400	1,500	1,590	1,800
	Med		1,300	1,300	1,340	1,340	1,400	1,500	1,590
	Med-L		1,270	1,270	1,300	1,300	1,340	1,400	1,440
	Low		1,200	1,200	1,280	1,280	1,280	1,300	1,300
	Quiet		1,150	1,150	1,150	1,150	1,150	1,150	1,150
Sound pressure level	High	dB(A)	38	38	39	39	41	44	47
	Med-H		37	37	38	38	40	42	45
	Med		36	36	37	37	38	40	42
	Med-L		35	35	36	36	37	38	39
	Low		34	34	35	35	36	36	36
	Quiet		33	33	33	33	33	33	33
Dimensions (H × W × D)		mm	288 × 840 × 840						
Weight		kg(lbs)	26.5 (58)	26.5 (58)	29.5 (65)	29.5 (65)	29.5 (65)	29.5 (65)	
Connection pipe diameter	Liquid (Flare)	Inch	1/4		3/8				
	Gas (Flare)	Inch	1/2		5/8				
Cassette Grille	Model name	UTG-UKYC-W							
	Dimensions (H×W×D)	mm	53×950×950						
	Weight	kg(lbs)	6.0 (13)						

Note : Specifications are based on the following conditions.

Cooling : Indoor temperature of 27°CDB / 19°CWB, and outdoor temperature of 35°CDB / 24°CWB.

Heating : Indoor temperature of 20°CDB / (15°CWB), and outdoor temperature of 7°CDB / 6°CWB.

Pipe length : 7.5 m; Height difference between outdoor unit and indoor unit : 0 m. Voltage : 230 [V].

When AUX\*018GLEH is connected to the outdoor unit other than J-IVL, pipe diameter should be  $\varnothing 9.52/\varnothing 15.88$  (Liq/Gas)

When AUXK036GLEH, AUXK045GLEH, and AUXK054GLEH are connected to the outdoor unit other than J-IVL, gas pipe diameter should be  $\varnothing 19.05$ .

## Optional parts

Human Sensor Kit: UTY-SHZXC

Fresh Air Intake Kit:

UTZ-VXRA

Cassette Grille:

UTG-UKYC-W

Wireless LAN Interface: UTY-TFSXZ1

External Power Supply Unit: UTZ-GXXA

IR Receiver Unit:

UTY-LBHXD

Wireless interface for use with Smart home products: FJ-AC-WIFI-1

## Dimensions

(Unit : mm)

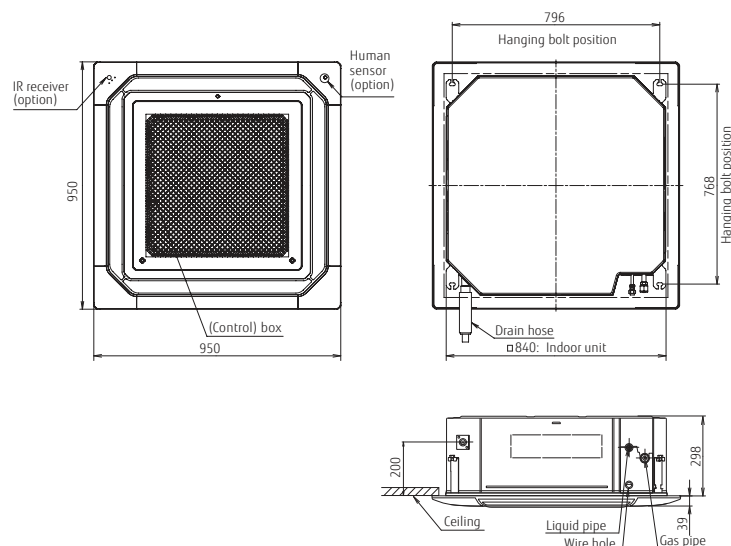

Model : AUXA18GALH / AUXA24GALH / AUXA30GALH  
 AUXA34GALH / AUXA36GALH / AUXA45GALH  
 AUXA54GALH

# Cassette Large type 4-way Flow



## Specifications

Model name		AUXD18GALH*	AUXD24GALH*	AUXA30GALH	AUXA45GALH	AUXA54GALH	
Power source		Single phase, ~230V, 50Hz					
Capacity	UK Total Cooling	4.20	5.30	6.70	9.30	10.40	
	UK Sensible Cooling	3.90	4.80	6.00	7.70	8.40	
	UK Heating	5.90	7.40	9.30	13.00	14.90	
	Nominal Cooling	5.60	7.10	9.00	12.50	14.00	
	Nominal Heating	6.30	8.00	10.00	14.00	16.00	
Input power		W	51	51	59	99	119
Airflow rate	High	m <sup>3</sup> /h	1,420 (394)	1,420 (394)	1,600 (444)	1,900 (528)	2,000 (556)
	Med	1,230 (342)	1,230 (342)	1,300 (361)	1,370 (381)	1,370 (381)	
	Low	1,100/1,000*1 (306/278)	1,100/1,000*1 (306/278)	1,100 (306)	1,100 (306)	1,100 (306)	
Sound pressure level	High	dB(A)	40	40	40	46	47
	Med	36	36	38	39	39	
	Low	33/31*1	33/31*1	33/31*1	33/31*1	33/31*1	
Net Dimensions (H × W × D)		mm	288 × 840 × 840	288 × 840 × 840	288 × 840 × 840	288 × 840 × 840	288 × 840 × 840
Weight		kg(lbs)	27 (60)	27 (60)	27 (60)	27 (60)	27 (60)
Connection pipe diameter	Liquid (Flare)	Inch	3/8			3/4	
	Gas (Flare)		5/8			3/4	
Cassette Grille	Model name		UTG-UGYA-W				
	Net Dimensions (H×W×D)		mm				50 × 950 × 950
	Weight		kg(lbs)				5.5 (12)

Note : Specifications are based on the following conditions.

Cooling : Indoor temperature of 27°CDB / 19°CWB, and outdoor temperature of 35°CDB / 24°CWB.

Heating : Indoor temperature of 20°CDB / (15°CWB), and outdoor temperature of 7°CDB / 6°CWB.

Pipe length : 7.5 m; Height difference between outdoor unit and indoor unit : 0 m. Voltage : 230 [V].

\*1: This value is under cooling operation.

\*:AUXA18/24GALH can be connected to VR-IV / V-III Series only.

## Optional parts

- IR receiver unit: UTY-LRHYB1
- Fresh air intake kit: UTZ-VXGA
- Wireless LAN Interface: UTY-TFSXZ1
- Cassette Grille: UTG-UGYA-W
- Wireless interface for use with Smart home products: FJ-AC-WIFI-1

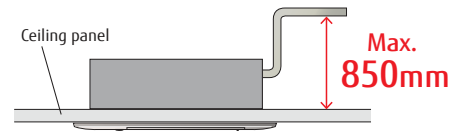

## Dimensions

(Unit : mm)

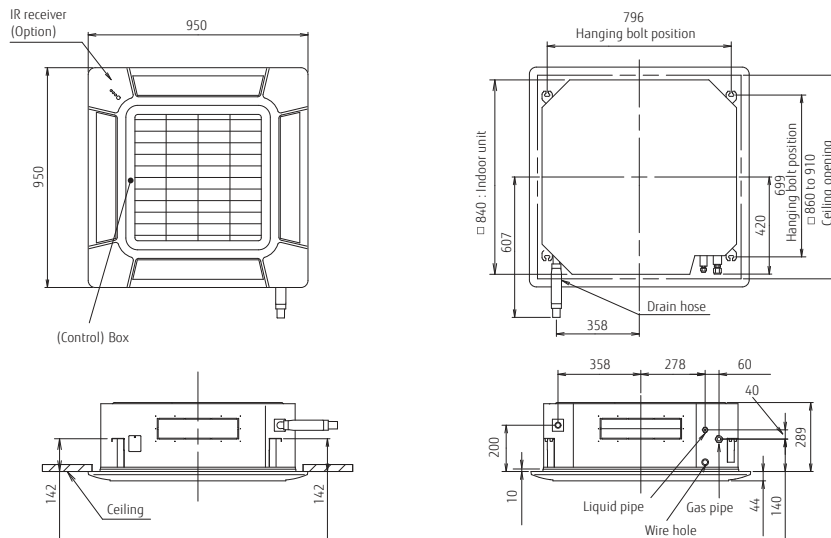

# Mini Duct (With drain pump)



ARXK007/009/012/014GLGH

## Specifications

Model name		ARXK004GLGH	ARXK007GLGH	ARXK009GLGH	ARXK012GLGH	
Power source		Single phase, ~230V, 50Hz				
Capacity	UK Total Cooling	0.80	1.60	2.10	2.70	
	UK Sensible Cooling	0.70	1.50	1.80	2.30	
	UK Heating	1.20	2.60	3.00	3.70	
	Nominal Cooling	1.1	2.20	2.80	3.60	
	Nominal Heating	1.3	2.80	3.20	4.00	
Input power		W	26	28	28	35
Airflow rate	High	460	460	460	550	
	Med-H	440	440	440	520	
	Med	420	420	420	480	
	Med-L	400	400	400	450	
	Low	370	370	370	410	
	Quiet	340	340	340	340	
Static pressure range		Pa	0 to 30	0 to 30	0 to 30	0 to 30
Standard static pressure			10	10	10	10
Sound pressure level	High	25	26	26	29	
	Med-H	24	25	25	27	
	Med	23	24	24	26	
	Med-L	22	23	23	25	
	Low	21	22	22	24	
	Quiet	20	21	21	22	
Net Dimensions (H × W × D)		mm	198 × 700 × 450	198 × 700 × 450	198 × 700 × 450	198 × 700 × 450
Weight		kg(lbs)	14.5 (32)	15.5 (34)	15.5 (34)	16 (35)
Connection pipe diameter	Liquid (Flare)	Inch	1/4			
	Gas (Flare)		1/2			

Note : Specifications are based on the following conditions.

Cooling : Indoor temperature of 27°CDB / 19°CWB, and outdoor temperature of 35°CDB / 24°CWB.

Heating : Indoor temperature of 20°CDB / (15°CWB), and outdoor temperature of 7°CDB / 6°CWB.

Pipe length : 7.5 m; Height difference between outdoor unit and indoor unit : 0 m. Voltage : 230 [V].

## Optional parts

Remote Sensor Unit : UTY-XSZX Auto Louvre Grille Kit: UTD-GXSA-W (004/007/009/012/014)  
 IR Receiver Unit : UTB-YWC UTD-GXSB-W (018)  
 External Power Supply Unit: UTZ-GXXA UTD-GXSC-W (024)

Wireless interface for use with Smart home products: FJ-AC-WIFI-1

## Auto Louvre Grille Kit (Option)

Thin design provides a comfortable living environment over a wide area. Automatic louvre grille provides comfortable air conditioning all the way down to the floor and matches the interior design well. (Optional)

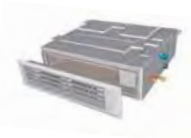

## Dimensions

(Unit : mm)

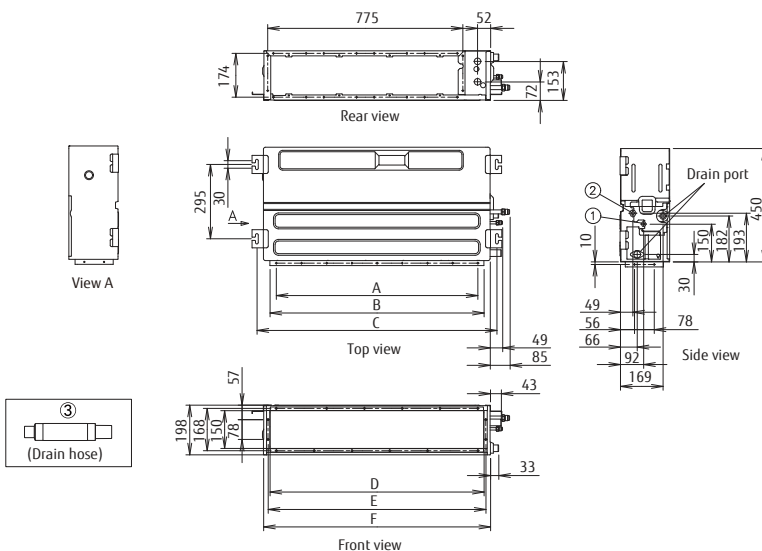

- ① Refrigerant pipe flare connection (Liquid)
- ② Refrigerant pipe flare connection (Gas)
- ③ Drain hose connection

	ARXK004-014	ARXK018	ARXK024
A	P100×6=600	P100×8=800	P100×10=1000
B	650	850	1050
C	752	952	1152
D	650	850	1050
E	665	864	1064
F	700	900	1100

Model : ARXD007GLEH / ARXD009GLEH / ARXD012GLEH / ARXD014GLEH / ARXD018GLEH / ARXD024GLEH

# Slim Duct / Slim Concealed Floor



ARXD04GALH  
ARXD007/009/012/014GLEH



ARXD018GLEH

Slim Concealed Floor



ARXD024GLEH

## Specifications

Model name		ARXD007GLEH	ARXD009GLEH	ARXD012GLEH	ARXD014GLEH	ARXD018GLEH	ARXD024GLEH	
Power source		Single phase, ~230V, 50Hz						
Capacity	UK Total Cooling	kW	1.60	2.10	2.70	3.30	4.20	5.30
	UK Sensible Cooling		1.50	1.80	2.30	2.90	3.50	4.90
	UK Heating		2.60	3.00	3.70	4.70	5.90	7.40
	Nominal Cooling		2.20	2.80	3.60	4.50	5.60	7.10
	Nominal Heating		2.80	3.20	4.00	5.00	6.30	8.00
Input power		W	44	50	54	92	83	122
Airflow rate	High	m <sup>3</sup> /h	550	600	600	800	940	1,330
	Med-H		480	510	530	680	820	1,140
	Med		440	460	490	600	730	1,020
	Med-L		410	420	450	520	630	900
	Low		370	370	410	440	540	780
	Quiet	320	320	340	340	470	610	
Static pressure range		Pa	0 to 90	0 to 90	0 to 90	0 to 90	0 to 90	0 to 50
Standard static pressure			25	25	25	25	25	25
Sound pressure level	High	dB(A)	28	29	30	34	34	35
	Med-H		26	27	28	32	31	31
	Med		25	25	27	30	29	29
	Med-L		24	24	26	28	27	27
	Low		22	22	24	25	25	24
	Quiet	21	21	22	22	23	21	
Net Dimensions (H × W × D)		mm	198 × 700 × 620	198 × 700 × 620	198 × 700 × 620	198 × 700 × 620	198 × 900 × 620	198 × 1,100 × 620
Weight		kg(lbs)	17 (37)	17 (37)	18 (40)	18 (40)	22 (48)	26 (57)
Connection pipe diameter	Liquid (Flare)	Inch			1/4			3/8
	Gas (Flare)		3/8			1/2	5/8	

Note : Specifications are based on the following conditions.

Cooling : Indoor temperature of 27°CDB / 19°CWB, and outdoor temperature of 35°CDB / 24°CWB.

Heating : Indoor temperature of 20°CDB / (15°CWB), and outdoor temperature of 7°CDB / 6°CWB.

Pipe length : 7.5 m; Height difference between outdoor unit and indoor unit : 0 m. Voltage : 230 [V].

\*1: This value is under cooling operation.

\*:ARXD04GALH cannot be connected to J-IVS / J-IV / J-IVL Series.

## Optional parts

Remote Sensor Unit : UTY-XSZX  
 IR Receiver Unit : UTB-YWC (004)  
 External Power Supply Unit : UTZ-GXXA

Auto Louvre Grille Kit: UTD-GXSA-W (04/007/009/012/014)  
 UTD-GXSB-W (018)  
 UTD-GXSC-W (024)

Wireless interface for use with Smart home products: FJ-AC-WIFI-1

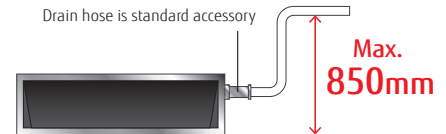

## Dimensions

(Unit : mm)

\*Service accessibility must be allowed for when installing the product. Please consult the installation manual for the necessary service access size.

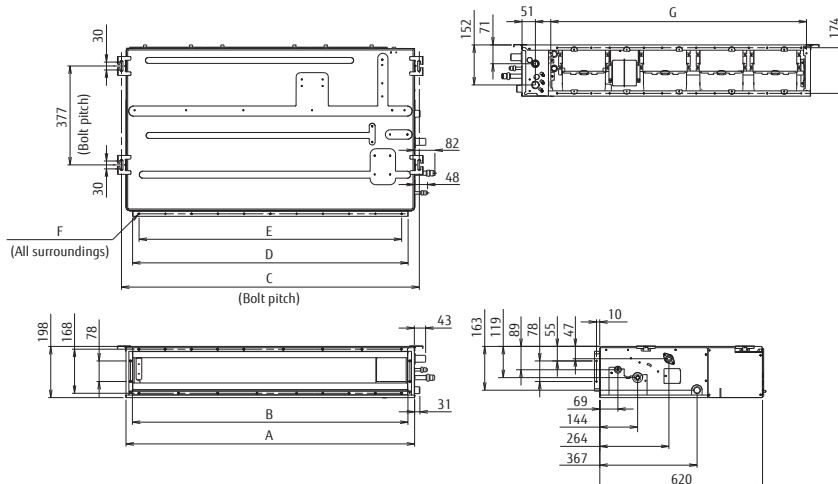

	ARXD04-014	ARXD018	ARXD024
A	700	900	1100
B	650	850	1050
C	734	934	1134
D	650	850	1050
E	P100×6=600	P100×8=800	P100×10=1000
F	18×Ø5	22×Ø5	26×Ø5
G	574	774	974

# Medium Static Pressure Duct



## Specifications

Model name		ARXA024GLEH	ARXA030GLEH	ARXA036GLEH	ARXA045GLEH
Power source		Single phase, ~230V, 50Hz			
Capacity	UK Total Cooling	5.30	6.70	8.30	9.30
	UK Sensible Cooling	4.70	5.60	7.00	7.90
	UK Heating	7.40	9.30	11.60	13.00
	Nominal Cooling	7.10	9.00	11.20	12.50
	Nominal Heating	8.00	10.00	12.50	14.00
Input power	W	94	108	194	240
Airflow rate	High	1,280	1,410	1,840	1,970
	Med-H	1,180	1,350	1,750	1,910
	Med	1,090	1,280	1,660	1,860
	Med-L	1,000	1,240	1,600	1,780
	Low	920	1,190	1,530	1,710
Quiet	840	1,150	1,470	1,640	
Static pressure range	Pa	0 to 150	0 to 150	0 to 150	0 to 150
Standard static pressure	Pa	40	50	50	60
Sound pressure level	High	31	34	37	41
	Med-H	29	33	36	40
	Med	27	32	35	38
	Med-L	26	31	35	38
	Low	24	30	34	37
Quiet	23	29	33	36	
Net Dimensions (H × W × D)	mm	270 × 1,135 × 700	270 × 1,135 × 700	270 × 1,135 × 700	270 × 1,135 × 700
Weight	kg(lbs)	36 (79)	40 (88)	40 (88)	40 (88)
Connection pipe diameter	Liquid (Flare)	3/8			
	Gas (Flare)	5/8			

Note : Specifications are based on the following conditions.

Cooling : Indoor temperature of 27°CDB / 19°CWB, and outdoor temperature of 35°CDB / 24°CWB.

Heating : Indoor temperature of 20°CDB / (15°CWB), and outdoor temperature of 7°CDB / 6°CWB.

Pipe length : 7.5 m; Height difference between outdoor unit and indoor unit : 0 m. Voltage : 230 [V].

## Optional parts

Long Life Filter :	UTD-LF25NA	IR Receiver Unit :	UTY-TRHX
Flange (Square) :	UTD-SF045T	Drain Pump Unit :	UTZ-PX1NBA
Flange (Round) :	UTD-RF204	Wireless LAN Interface :	UTY-TFSXZ1
External Power Supply Unit :	UTZ-GXXA		

Wireless interface for use with Smart home products: FJ-AC-WIFI-1

## Dimensions

(Unit : mm)

\*Service accessibility must be allowed for when installing the product.  
Please consult the installation manual for the necessary service access size.

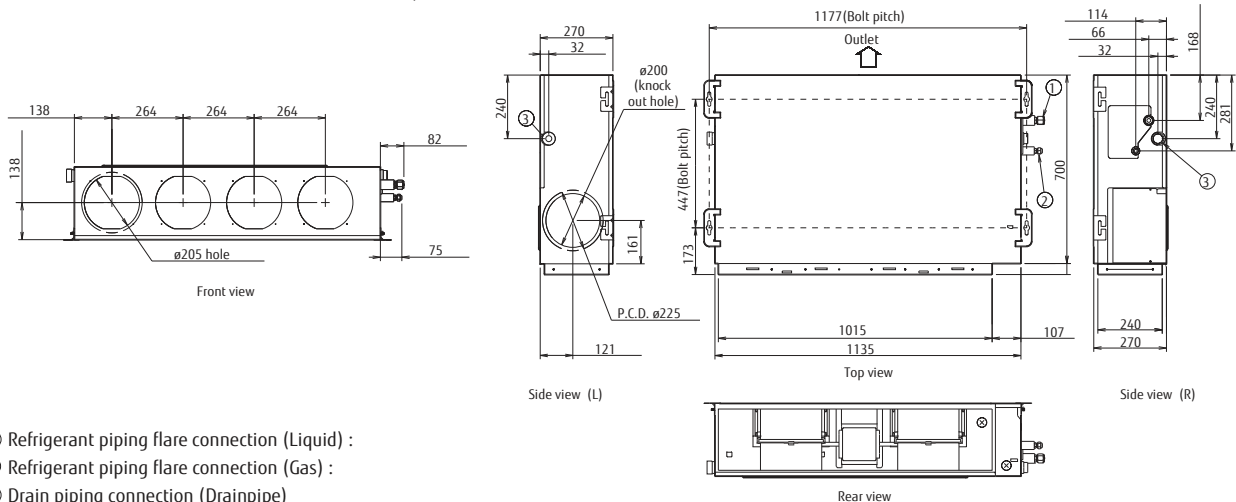

Model : ARXC036GTEH / ARXC45GATH / ARXC60GATH  
 ARXC072GTEH / ARXC090GTEH / ARXC096GTEH

# High Static Pressure Duct



ARXC072/090GTEH

ARXC096GTEH

## Specifications

Model name		ARXC036GTEH	ARXC45GATH	ARXC60GATH*	ARXC072GTEH*	ARXC090GTEH*	ARXC096GTEH*	
Power source		Single phase, ~230V, 50Hz						
Capacity	UK Total Cooling	8.3	9.3	13.4	16.6	18.6	20.8	
	UK Sensible Cooling	7.4	9.2	12.2	15.1	15.6	16.7	
	UK Heating	11.6	13.0	18.6	23.3	26.0	29.3	
	Nominal Cooling	11.2	12.5	18.0	22.4	25.0	28.0	
	Nominal Heating	12.5	14.0	20.0	25.0	28.0	31.5	
Input power	W	207	715	730	681	819	838	
Airflow rate	High	1,990	3,500	3,500	3,900	4,300	4,850	
	Med	1,680	3,000	3,000	3,300	4,000	4,250	
	Low	1,330	2,460	2,460	3,000	3,500	3,600	
Static pressure range	Pa	0 to 200	100 to 250	100 to 250	0 to 300	0 to 300	0 to 300	
Standard static pressure		100	100	100	150	150	150	
Sound pressure level	High	42	49	49	47	48	48	
	Med	36	45	45	43	46	45	
	Low	32	42	42	40	44	42	
Net Dimensions (H × W × D)	mm	400 × 1,050 × 500	400 × 1,050 × 500	400 × 1,050 × 500	450 × 1,587 × 700	450 × 1,587 × 700	550 × 1,587 × 700	
Weight	kg(lbs)	40 (88)	46 (101)	46 (101)	84 (185)	84 (185)	105 (231)	
Connection pipe diameter	Liquid	Inch	3/8 (Flare)				3/8 (Brazing)	
	Gas		5/8 (Flare)	3/4 (Flare)			7/8 (Brazing)	

Note : Specifications are based on the following conditions.  
 Cooling : Indoor temperature of 27°CDB / 19°CWB, and outdoor temperature of 35°CDB / 24°CWB.  
 Heating : Indoor temperature of 20°CDB / (15°CWB), and outdoor temperature of 7°CDB / 6°CWB.  
 Pipe length : 7.5 m; Height difference between outdoor unit and indoor unit : 0 m. Voltage : 230 [V].  
 \*: ARXC60/072/090/096G cannot be connected to J-IVJ-IVS Series.

## Optional parts

- Long-Life Filter : UTD-LF60KA (036/45/60)
  - IR Receiver Unit : UTB-YWC (45/60)  
 UTY-TRHX (036/072/090/096)
  - External Power Supply Unit : UTZ-GXXA (036/072/090/096)
  - Wireless LAN Interface : UTY-TFSXZ1 (036/072/090/096)
- Wireless interface for use with Smart home products: FJ-AC-WIFI-1

## Dimensions

(Unit : mm)

Models: ARXC036 / ARXC45 / ARXC60

Models: ARXC072 / ARXC090

Models: ARXC096

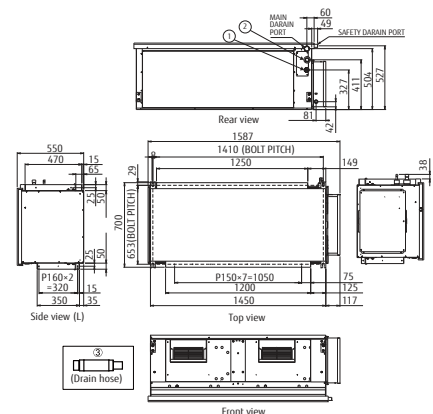
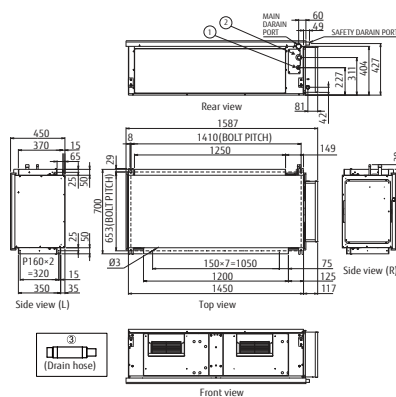
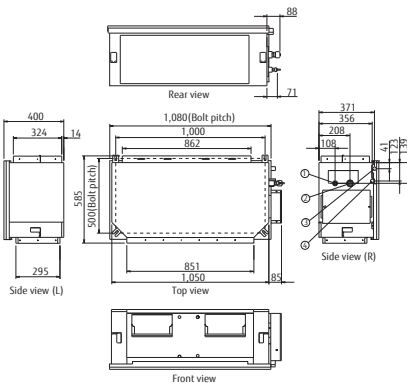

- ① Refrigerant piping flare connection (Liquid)
- ② Refrigerant piping flare connection (Gas)
- ③ Drain piping connection

- ① Refrigerant pipe flare connection (Liquid)
- ② Refrigerant pipe flare connection (Gas)
- ③ Drain hose

- ① Refrigerant pipe flare connection (Liquid)
- ② Refrigerant pipe flare connection (Gas)
- ③ Drain hose



Model : AGYA007GCGH / AGYA009GCGH  
 AGYA012GCGH / AGYA014GCGH

## Compact floor



### Specifications

Model name		AGYA007GCGH	AGYA009GCGH	AGYA012GCGH	AGYA014GCGH
Power source		Single-phase, ~230V, 50Hz			
Capacity	UK Total Cooling	1.60	2.10	2.70	3.00
	UK Sensible Cooling	1.40	1.70	2.30	2.50
	UK Heating	2.60	3.00	3.70	4.20
	Nominal Cooling	2.20	2.80	3.60	4.00
	Nominal Heating	2.80	3.20	4.00	4.50
Input power	W	16	17	22	29
Airflow rate	High	470	500	590	670
	Med-H	420	450	520	590
	Med	390	400	470	520
	Med-L	360	360	420	450
	Low	330	330	390	390
	Quiet	270	270	340	340
Sound pressure level	High	37	38	42	46
	Med-H	35	36	39	42
	Med	33	34	37	39
	Med-L	31	31	35	36
	Low	29	29	33	33
Quiet	22	22	30	30	
Net Dimensions (H × W × D)		mm 600 x 740 x 200			
Weight		kg(lbs) 15 (33)			
Connection pipe diameter	Liquid (Flare)			1/4	
	Gas (Flare)	3/8		1/2	

Note : Specifications are based on the following conditions.

Cooling : Indoor temperature of 27°CDB / 19°CWB, and outdoor temperature of 35°CDB / 24°CWB.

Heating : Indoor temperature of 20°CDB / (15°CWB), and outdoor temperature of 7°CDB / 6°CWB.

Pipe length : 7.5 m; Height difference between outdoor unit and indoor unit : 0 m. Voltage : 230 [V].

When AGYA007/009GCGH, are connected to the outdoor unit other than J-IVL, gas pipe diameter should be Ø12.70.

### Optional parts

Half concealed kit: UTR-STA

External Power Supply Unit : UTZ-GXXA

Wireless LAN Interface : UTY-TFSXZ1

Wireless interface for use with Smart home products: FJ-AC-WIFI-1

### Dimensions

(Unit : mm)

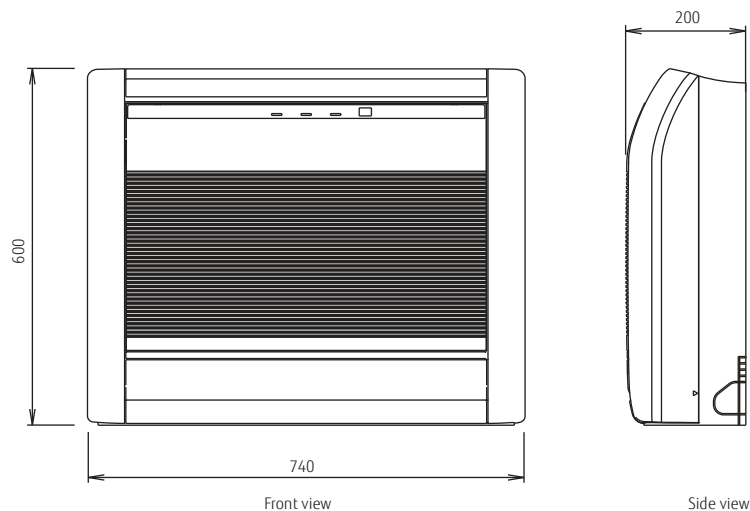

# Floor / Ceiling

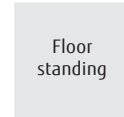

## Specifications

Model name		ABYA012GTEH	ABYA014GTEH	ABYA018GTEH	ABYA024GTEH	
Power source		Single phase, ~230V, 50Hz				
Capacity	UK Total Cooling	2.70	3.30	4.20	5.30	
	UK Sensible Cooling	2.40	3.00	3.80	4.20	
	UK Heating	3.70	4.70	5.90	7.40	
	Nominal Cooling	3.60	4.50	5.60	7.10	
	Nominal Heating	4.00	5.00	6.30	8.00	
Input power		W	30	42	74	99
Airflow rate	High	660	780	1,000	1,000	
	Med-H	620	740	910	930	
	Med	580	690	830	870	
	Med-L	550	640	750	800	
	Low	520	600	660	740	
	Quiet	490	550	580	680	
Sound pressure level	High	36	40	46	47	
	Med-H	34	39	44	45	
	Med	33	38	42	43	
	Med-L	31	36	40	41	
	Low	29	35	37	39	
Quiet	28	34	35	37		
Net Dimensions (H × W × D)		mm	199 × 990 × 655	199 × 990 × 655	199 × 990 × 655	199 × 990 × 655
Weight		kg(lbs)	25 (55)	26 (57)	26 (57)	27 (60)
Connection pipe diameter	Liquid (Flare)	Inch	1/4		3/8	
	Gas (Flare)		1/2		5/8	

Note : Specifications are based on the following conditions.  
 Cooling : Indoor temperature of 27°CDB / 19°CWB, and outdoor temperature of 35°CDB / 24°CWB.  
 Heating : Indoor temperature of 20°CDB / (15°CWB), and outdoor temperature of 7°CDB / 6°CWB.  
 Pipe length : 7.5 m; Height difference between outdoor unit and indoor unit : 0 m. Voltage : 230 [V].

## Optional parts

External Power Supply Unit : UTZ-GXXA

Wireless LAN Interface : UTY-TFSXZ1

Wireless interface for use with Smart home products: FJ-AC-WIFI-1

## Dimensions

(Unit : mm)

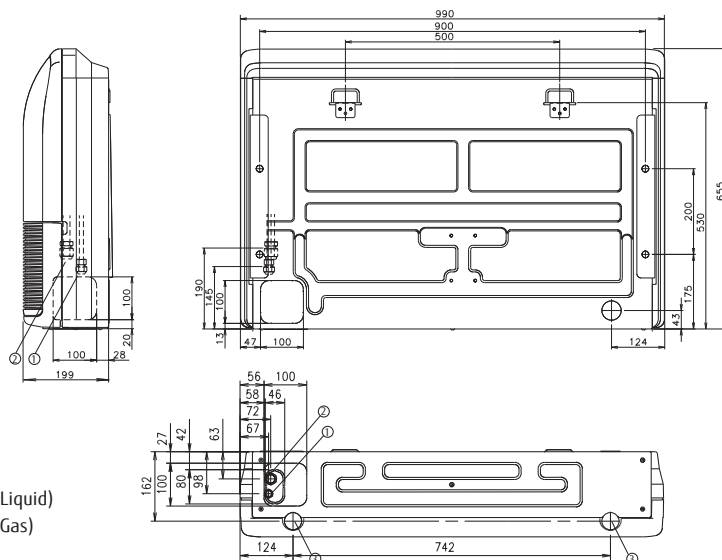

- ① Refrigerant piping flare connection (Liquid)
- ② Refrigerant piping flare connection (Gas)
- ③ Drain piping connection

# Ceiling



## Specifications

Model name		ABYA030GTEH	ABYA036GTEH	ABYA045GTEH	ABYA054GTEH
Power source		Single phase, ~230V, 50Hz			
Capacity	UK Total Cooling	6.70	8.30	9.30	10.40
	UK Sensible Cooling	6.10	6.90	7.90	8.90
	UK Heating	9.30	11.60	13.00	14.90
	Nominal Cooling	9.00	11.20	12.50	14.00
	Nominal Heating	10.00	12.50	14.00	16.00
Input power	W	66	85	131	180
Airflow rate	High	1,630	1,690	2,010	2,270
	Med-H	1,520	1,560	1,840	2,070
	Med	1,420	1,450	1,690	1,860
	Med-L	1,320	1,360	1,530	1,660
	Low	1,220	1,270	1,380	1,470
Sound pressure level	Quiet	1,140	1,170	1,230	1,280
	High	42	45	48	51
	Med-H	40	41	46	49
	Med	39	39	45	46
	Med-L	37	38	41	43
Net Dimensions (H × W × D)	mm	240 × 1,660 × 700	240 × 1,660 × 700	240 × 1,660 × 700	240 × 1,660 × 700
	kg(lbs)	46 (101)	48 (106)	48 (106)	48 (106)
Connection pipe diameter	Liquid (Flare)			3/8	
	Gas (Flare)			5/8	

Note : Specifications are based on the following conditions.

Cooling : Indoor temperature of 27°CDB / 19°CWB, and outdoor temperature of 35°CDB / 24°CWB.

Heating : Indoor temperature of 20°CDB / (15°CWB), and outdoor temperature of 7°CDB / 6°CWB.

Pipe length : 7.5 m; Height difference between outdoor unit and indoor unit : 0 m. Voltage : 230 [V].

## Optional parts

Drain Pump Unit : UTR-DPB24T

Flange : UTD-RF204

External Power Supply Unit : UTZ-GXXA

Wireless LAN Interface : UTY-TFSXZ1

Wireless interface for use with Smart home products: FJ-AC-WIFI-1

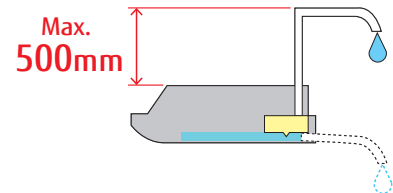

## Dimensions

(Unit : mm)

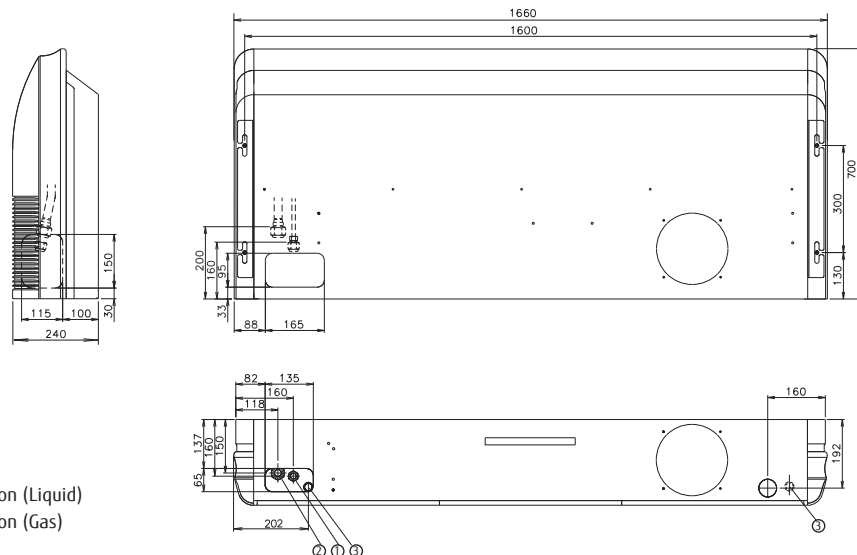

- ① Refrigerant piping flare connection (Liquid)
- ② Refrigerant piping flare connection (Gas)
- ③ Drain piping connection

Model : ASYA004GTEH / ASYA007GTEH / ASYA009GTEH  
 ASYE004GTEH / ASYE007GTEH / ASYE009GTEH

# Wall Mounted



## Specifications

Model name		ASYA004GTEH	ASYA007GTEH	ASYA009GTEH	ASYE004GTEH	ASYE007GTEH	ASYE009GTEH
Power source		Single phase, ~230V, 50Hz			Single phase, ~230V, 50Hz		
Capacity	UK Total Cooling	0.80	1.60	2.10	0.80	1.60	2.10
	UK Sensible Cooling	0.70	1.60	1.90	0.70	1.50	2.00
	UK Heating	1.20	2.60	3.00	1.20	2.60	3.00
	Nominal Cooling	1.10	2.20	2.80	1.10	2.20	2.8
	Nominal Heating	1.30	2.80	3.20	1.30	2.80	3.2
Input power	W	13	19	34	13	19	34
Airflow rate	High	430	550	720	430	550	720
	Med-H	420	460	570	420	460	570
	Med	390	420	500	390	420	500
	Med-L	380	390	410	380	390	410
	Low	360	360	360	360	360	360
	Quiet	330	330	330	330	330	330
Sound pressure level	High	31	35	43	31	35	43
	Med-H	30	32	38	30	32	38
	Med	28	30	34	28	30	34
	Med-L	26	27	29	26	27	29
	Low	24	24	24	24	24	24
Quiet	22	22	22	22	22	22	
Net Dimensions (H × W × D)	mm	262 x 820 x 206	262 x 820 x 206	262 x 820 x 206	262 x 820 x 206	262 x 820 x 206	262 x 820 x 206
Weight	kg(lbs)	7.5 (17)	7.5 (17)	7.5 (17)	7.0 (15)	7.0 (15)	7.0 (15)
Connection pipe diameter	Liquid (Flare)			1/4			
	Gas (Flare)			3/8			
EV Kit (option)		-			UTR-EV09XB		

Note : Specifications are based on the following conditions.  
 Cooling : Indoor temperature of 27°CDB / 19°CWB, and outdoor temperature of 35°CDB / 24°CWB.  
 Heating : Indoor temperature of 20°CDB / (15°CWB), and outdoor temperature of 7°CDB / 6°CWB.  
 Pipe length : 7.5 m; Height difference between outdoor unit and indoor unit : 0 m. Voltage : 230 [V].  
 When ASY\*004GTEH, ASY\*007GTEH, ASY\*009GTEH are connected to the outdoor unit other than J-IVL, gas pipe diameter should be Ø12.70.

## Optional parts

External Power Supply Unit : UTZ-GXXA  
 Wireless LAN Interface : UTY-TFSXZ1  
 Wireless interface for use with Smart home products: FJ-AC-WIFI-1

## Dimensions

(Unit : mm)

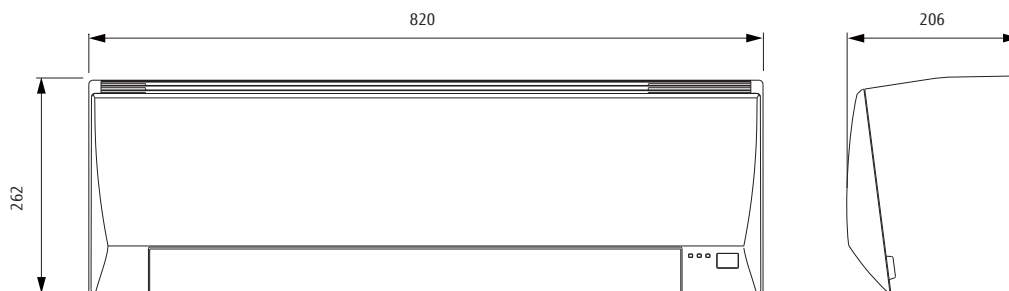

Model : ASYA012GCEH / ASYA014GCEH  
 ASYE012GCEH / ASYE014GCEH

# Wall Mounted



## Specifications

Model name		ASYA012GCEH	ASYA014GCEH	ASYE012GCEH	ASYE014GCEH
Power source		Single phase, ~230V, 50Hz		Single phase, ~230V, 50Hz	
Capacity	UK Total Cooling	2.70	3.00	2.70	3.00
	UK Sensible Cooling	2.30	2.70	2.30	2.70
	UK Heating	3.70	4.20	3.70	4.20
	Nominal Cooling	3.60	4.00	3.6	4.0
	Nominal Heating	4.00	4.50	4.0	4.5
Input power	W	25	36	25	36
Airflow rate	High	690	800	690	800
	Med-H	610	740	610	740
	Med	560	680	560	680
	Med-L	530	610	530	610
	Low	470	550	470	550
	Quiet	330	330	330	330
Sound pressure level	High	40	44	40	44
	Med-H	37	42	37	42
	Med	35	40	35	40
	Med-L	33	37	33	37
	Low	30	34	30	34
Quiet	24	24	24	24	
Net Dimensions (H × W × D)	mm	268 × 840 × 203	268 × 840 × 203	268 × 840 × 203	268 × 840 × 203
Weight	kg(lbs)	8.5 (19)	8.5 (19)	8.5 (19)	8.5 (19)
Connection pipe diameter	Liquid (Flare)			1/4	
	Gas (Flare)			1/2	
EV Kit (option)		-		UTR-EV14XB	

Note : Specifications are based on the following conditions.  
 Cooling : Indoor temperature of 27°CDB / 19°CWB, and outdoor temperature of 35°CDB / 24°CWB.  
 Heating : Indoor temperature of 20°CDB / (15°CWB), and outdoor temperature of 7°CDB / 6°CWB.  
 Pipe length : 7.5 m; Height difference between outdoor unit and indoor unit : 0 m. Voltage : 230 [V].

## Optional parts

External Power Supply Unit : UTZ-GXXA  
 Wireless LAN Interface : UTY-TFSXZ1

Wireless interface for use with Smart home products: FJ-AC-WIFI-1

## Dimensions

(Unit : mm)

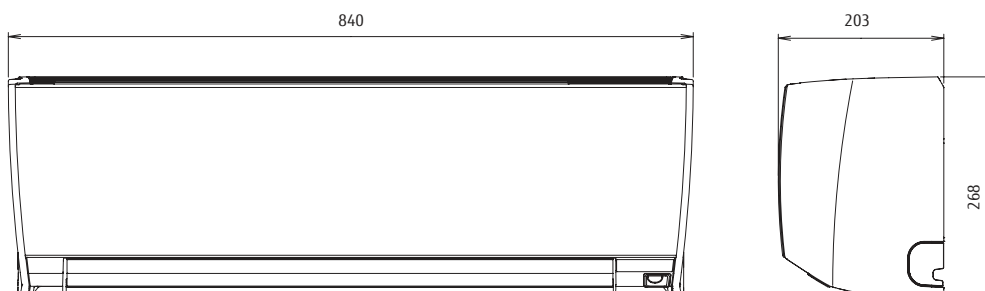

# Wall Mounted



ASYA18/24GBCH



ASYA030/034GTEH

## Specifications

Model name		ASYA18GBCH	ASYA24GBCH	ASYA030GTEH	ASYA034GTEH	
Power source		Single phase, ~230V, 50Hz		Single phase, ~230V, 50Hz		
Capacity	UK Total Cooling	4.20	5.30	6.70	7.40	
	UK Sensible Cooling	3.90	4.80	5.70	6.50	
	UK Heating	5.90	7.40	9.30	10.40	
	Cooling	5.60	7.10	9.00	10.00	
	Heating	6.30	8.00	10.00	11.20	
Input power	W	32	60	74	103	
Airflow rate	High	840	1,100	1,440	1,620 / 1,520	
	Med-H	-	-	1,200	1,300	
	Med	770	910	1,050	1,120	
	Med-L	-	-	940	980	
	Low	690	730	890	890	
	Quiet	-	-	700	700	
Sound pressure level	High	41	48	53	55 / 54	
	Med-H	-	-	49	51	
	Med	39	43	45	47	
	Med-L	-	-	42	43	
	Low	35	35	39	39	
	Quiet	-	-	33	33	
Net Dimensions (H × W × D)		mm	320 x 998 x 238	320 x 998 x 238	340 x 1,150 x 280	340 x 1,150 x 280
Weight		kg(lbs)	15 (33)	15 (33)	18 (40)	18 (40)
Connection pipe diameter	Liquid (Flare)	Inch	1/4		3/8	
	Gas (Flare)		1/2		5/8	

Note : Specifications are based on the following conditions.

Cooling : Indoor temperature of 27°CDB / 19°CWB, and outdoor temperature of 35°CDB / 24°CWB.

Heating : Indoor temperature of 20°CDB / (15°CWB), and outdoor temperature of 7°CDB / 6°CWB.

Pipe length : 7.5 m; Height difference between outdoor unit and indoor unit : 0 m. Voltage : 230 [V].

When ASYA18GBCH is connected to the outdoor unit other than J-IVL, pipe diameter should be Ø9.52/Ø15.88 (Liq/Gas).

## Optional parts

External Power Supply Unit : UTZ-GXXA (030/034)

Wireless LAN Interface : UTY-TFSXZ1 (030/034)

Wireless LAN Interface : FJ-RC-WIFI-2 (18/24)

Wireless interface for use with Smart home products: FJ-AC-WIFI-1 (030/034)

## Dimensions

(Unit : mm)

Models: ASYA18 / ASYA24

Models: ASYA030 / ASYA034

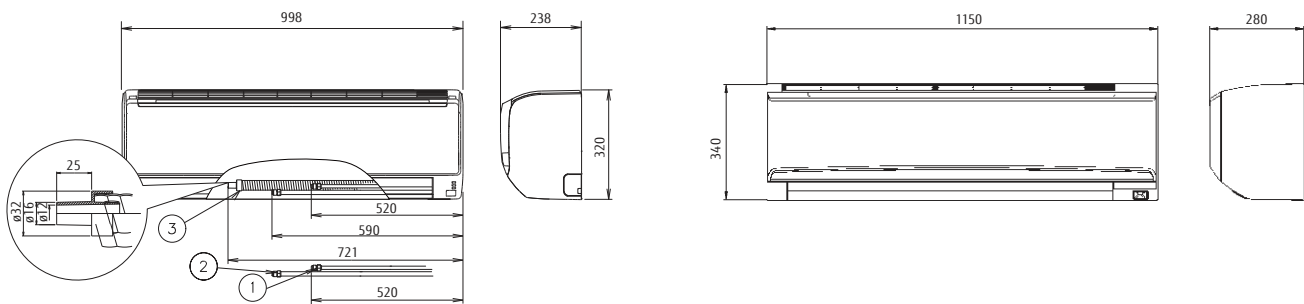

- ① Refrigerant piping flare connection (Liquid)
- ② Refrigerant piping flare connection (Gas)
- ③ Drain piping connection



VRF

Linwood now offer an extensive range of plenum boxes to suit the Fujitsu General Air Conditioning UK range of ducted air conditioning indoor units

Installing air conditioning ducted fan coil units (FCU's) just got easier with these purpose made plenum boxes designed to save you time and money when fitting VRF or split air conditioning systems

Easy to use online ordering & live order processing via [www.airconplenums.com/fujitsu-plenum](http://www.airconplenums.com/fujitsu-plenum)  
*filter not supplied with plenum*

# Control System Overview

For VRF

User's needs are supported by offering a variety of controls, such as individual control, central control and building management control options.

## Air Conditioning Individual Control



**Wired Remote Controller (Touch panel)**  
UTY-RNRYZ3



**NEW Compact Wired Remote Controller**  
UTY-RCRYZ1



**Simple Remote Controller**  
UTY-RSRY  
UTY-RHRY  
Without operation mode



**Wireless Remote Controller**  
UTY-LNHY



For Duct



For 3D Flow Cassette/  
Duct

**IR Receiver Unit**

UTB-YWC For Duct

UTY-TRHX  
For Duct



For Cassette



For Circular Flow Cassette

UTY-LRHYB1 For Cassette  
UTY-LBHXD  
For Circular Flow Cassette

## Air Conditioning Centralised Control

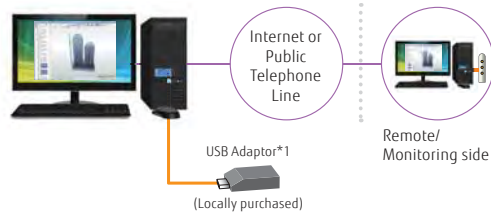

**System Controller Software**  
UTY-APGXZ1/UTY-ALGXZ1 (Lite edition)

**Max. Controllable 1600 indoor units**<sup>\*2</sup>

\*1: USB Adaptor: Echelon® U10 USB Network Interface  
\*2: Lite edition is max. controllable 400 indoor units



**Central Remote Controller**  
UTY-DCGYZ1

**Max. Controllable 100 indoor units**



**Touch Panel Controller**  
UTYDTGYZ1

**Max. Controllable 400 indoor units**





# Convertor/Adaptor

For external control via BMS/Home Automation Systems

## BACnet® Gateway

UTY-ABGXZ1 **Software**



## BACnet® Gateway

UTY-VBGX **Hardware**



## Network Convertor (For LONWORKS®)

UTY-VLGX



## MODBUS® Convertor For indoor unit

UTY-VMSX



## MODBUS® Convertor

UTY-VMGX



## MODBUS® Interface

FJRCMBS1



## KNX® Convertor For indoor unit

UTY-VKSX



## KNX® Convertor For VRF

UTY-VKGX



## KNX® Interface

FJRCKNX1i



## Wireless LAN Interface

UTY-TFSXZ1



## Wireless LAN Interface

FJRCWIF2

FJACWIF1



## External Switch Controller

UTY-TERX



Card-key  
(Locally purchased)



Internet device



BMS/BAS<sup>\*3</sup>

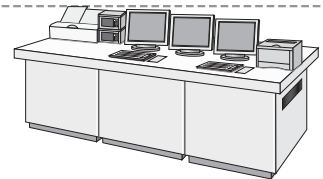

BMS<sup>\*3</sup>, Home automation system



\*3: BMS/BAS: Building Management System/Building Automation System

# Convertor/Adaptor

For system expansion

## Network Convertor

(DC power supply)

UTY-VTGX



## Network Convertor

(AC power supply)

UTY-VTGXV















## Signal Amplifier

UTY-VSGXZ1



# Controller System List (available) For VRF

Controller Options:

Type	Refrigerant	Indoor unit								
		Cassette				Duct				
		Compact Grid type /Standard type	Slim type	Large type	Large type	Low Static Pressure Duct		Medium Static Pressure		
			4-way Flow		Circular Flow	Mini (With drain pump)	Slim (With drain pump)	Normal		
R410A	AUXB 004/007/009/ 012/014/018/ 024GLEH	AUXD 18/24GALH	AUXA 18/24/30/ 34/36/45/54 GALH	AUXK 018/024/030/ 034/036/045/ 054GLEH	ARXK 004/007/009/ 012/014/018/ 024GLGH	ARXD 04GALH	ARXD 007/009/012/ 014/018/024 GLEH	ARXA 024/030/ 036/045 GLEH		
Controllers	 Wired Remote Controller	● UTY-RNRYZ3								
		● UTY-RLRY								
		● UTY-RCRYZ1								
Simple Remote Controller	 2-wire type 3-wire type	● UTY-RSRY UTY-RHRY	● UTY-RSRY, UTY-RHRY, UTY-RSKY, UTY-RHKY	● UTY-RSRY UTY-RHRY	● UTY-RSRY, UTY-RHRY, UTY-RSKY, UTY-RHKY	● UTY-RSRY UTY-RHRY	● UTY-RSRY UTY-RHRY	● UTY-RSRY UTY-RHRY		
Wireless Remote Controller		● UTY-LNHY								
Central Remote Controller		● UTY-DCGVZ1								
System Controller, System Controller Lite		● UTY-APGXZ1, UTY-ALGXZ1								
Interface	BACnet Gateway		● UTY-ABGXZ1, UTY-VBGX							
	Network Converter for LonWorks		● UTY-VLGX							
	MODBUS Converter		● UTY-VMSX		● UTY-VMSX		● UTY-VMSX	● UTY-VMSX		
	MODBUS Converter		● UTY-VMGX							
	KNX Converter		● UTY-VKSX		● UTY-VKSX		● UTY-VKSX	● UTY-VKSX		
	KNX Converter		● UTY-VKGX							
	Wireless LAN Interface		● UTY-TFSXZ1		● UTY-TFSXZ1		● UTY-TFSXZ1	● UTY-TFSXZ1		
	External Switch Controller		● UTY-TERX							



Indoor unit												
Duct		Floor				Wall Mounted						
High Static Pressure		-	EEV external	Ceiling/ Floor	Ceiling	-	EEV external	-	EEV external	-	-	
Normal												
ARXC 45/60GATH	ARXC 036/072/ 090/096 GTEH	AGYA 004/007/ 009/012/014 GCGH	AGYE 004/007/ 009/012/014 GCEH	ABYA 012/014/ 018/024 GTEH	ABYA 030/036/ 045/054 GTEH	ASVA 004/007/009 GTEH	ASVE 004/007/009 GTEH	ASVA 012/014GCEH	ASVE 012/014GCEH	ASVA 18/24GBCH	ASVA 030/034GTEH	
● UTY-RNRYZ3												
● UTY-RLRY												
● UTY-RCRYZ1												
● UTY-RSRY, UTY-RHRY, UTY-RSKY, UTY-RHKY	● UTY-RSRY UTY-RHRY							● UTY-RSRY, UTY-RHRY, UTY-RSKY, UTY-RHKY	● UTY-RSRY UTY-RHRY			
● UTY-LNHY												
● UTY-DCGYZ1												
● UTY-APGXZ1, UTY-ALGXZ1												
● UTY-ABGXZ1, UTY-VBGX												
● UTY-VLGX												
	● UTY-VMSX							● UTY-VMSX		● UTY-VMSX		
● UTY-VMGX												
	● UTY-VKSX							● UTY-VKSX		● UTY-VKSX		
● UTY-VKGX												
	● UTY-TFSXZ1							● UTY-TFSXZ1		● UTY-TFSXZ1		
● UTY-TERX												



# CONTROL SYSTEM & OPTIONAL PARTS



Fujitsu offers a wide product lineup to meet a variety of needs

We can flexibly meet customer needs through a variety of offerings including wired and wireless individual remote controllers, central remote controllers that simultaneously control multiple indoor units, and a variety of converters that link with other systems.

## CONTROL SYSTEM



### INDIVIDUAL CONTROL

- 190 Wired Remote Controller (Touch Panel)
- 190 Wired Remote Controller Compact Wired Remote Controller
- 191 Simple Remote Controller

### CONVERTOR/ADAPTOR

- 192 MODBUS® Convertor  
KNX® Convertor
- 193 Wireless LAN Interface
- 195 External Switch Controller



### INDIVIDUAL CONTROL

- 194 Wired Remote Controller
- 195 Wireless Remote Controller
- 196 IR Receiver Unit

### CENTRALISED CONTROL

- 197 Central Remote Controller

### CONVERTOR/ADAPTOR

- 198 MODBUS® Interface  
KNX® Interface
- 199 Wireless LAN Interface
- 200 Network Convertor for Single Split



### INDIVIDUAL CONTROL

- 201 Wireless Remote Controller  
IR Receiver Unit  
For Duct, Cassette

### CENTRALISED CONTROL

- 202 Central Remote Controller
- 204 System Controller **Software**  
System Controller Lite **Software**

### CONVERTOR/ADAPTOR

- 208 BACnet® Gateway **Software**
- 209 BACnet® Gateway **Hardware**  
Network Convertor for LONWORKS®
- 210 MODBUS® Convertor  
KNX® Convertor
- 211 Signal Amplifier

## OPTIONAL PARTS



- 214 Auto Louvre Grille Kit
- 215 External Power Supply Unit
- 
- 216 Optional Parts List
- 218 Function List
- 220 Separation Tube etc.
- 222 Service Tool
- 223 Web Monitoring Tool
- 
- 224 Leak Detection



SPLIT



MULTI-SPLIT



VRF J Series



VRF V Series

# Wired Remote Controller (Touch Panel)

UTY-RNRYZ3

SPLITS/MULTI/VRF



## Easy operation by high-definition large STN-LCD touch panel screen

- Easy finger touch operation with LCD panel
- Built-in weekly/daily timer (ON/OFF, Temp., Mode)
- Backlight enables easy operation in a darkened room
- Room temperature display
- Control up to 16 indoor units
- Corresponds to 12 different languages (English, Chinese, French, German, Spanish, Russian, Polish, Italian, Greek, Portuguese, Turkish and Dutch)
- 2-wire type

Max. Controllable  
**16** indoor units

Max. Controllable  
**1** Group

## High performance and compact size

In addition to the individual control, weekly timer, and various energy saving controls can be realised using one remote controller only.



### Specifications

Model name	UTY-RNRYZ3
Power Source	DC 12 V
Dimensions (H × W × D) (mm)	120 × 120 × 20.4
Weight (g)	220

DC 12 V is supplied by the indoor unit.

# Compact Wired Remote Controller

UTY-RCRYZ1

SPLITS/MULTI/VRF

NEW

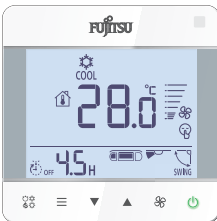

- Simple design to match the stylish interior
- Easy to install : Body of controller is designed to fit in European standard junction box
- Can be operated both by wireless and wired remote controller.
- 2-wire type

## Large screen and simple display

- Although the size is compact, the screen is large
- Large letters makes it easy to see
- Operation is simple and easy-to-understand

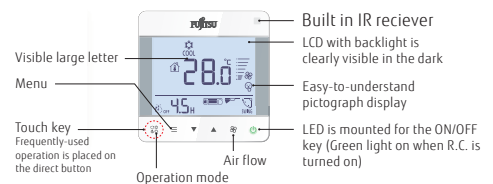

Max. Controllable  
**1** single indoor unit

Max. Controllable  
**1** Group

## System overview

### VRF connection

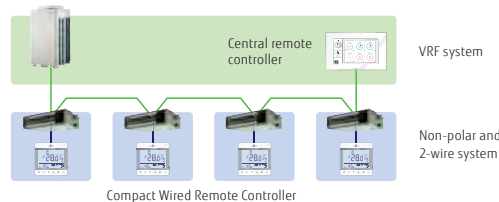

### RAC connection

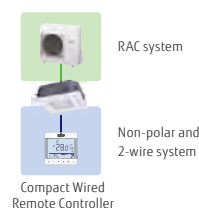

### Specifications

Model name	UTY-RLRY	UTY-RCRYZ1
Power Source	DC 12 V	DC12V
Dimensions (H × W × D) (mm)	120 × 120 × 17	86 × 86 × 44
Weight (g)	170	135

DC 12 V is supplied by the indoor unit.

# Simple Remote Controller

UTY-RSRY / UTY-RHRY (Without operation mode)

SPLITS/MULTI/VRF



UTY-RSRY

UTY-RHRY  
(Without operation mode)

## Compact remote controller provides access to basic functions

- Up to 16 indoor units can be controlled with one remote controller.
- Suitable for hotels or offices as it is easily operated with no complex functions.
- Stylish design: Simple design to match the stylish interior.
- Large LCD screen & simple operation buttons
- Backlight: White coloured backlight on monitor enable easy operation in dark.
- 2-wire type

Max. Controllable

**16** indoor units

Max. Controllable

**1** Group

## Corresponding to various applications

- **Vertical louvre control:** Vertical air flow direction can be adjusted for Duct types with auto louvre and Cassette types, which are installed in hotels and conference rooms, can be adjusted.
- **Room temperature set point limitation:** The Simple Remote Controller can manage to energy saving operation in small buildings without the central control unit.
- **Built in room temperature sensor:** The Simple Remote Controller detects actual room temperature and controls room climate accuracy.

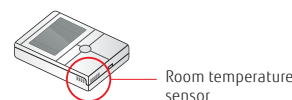
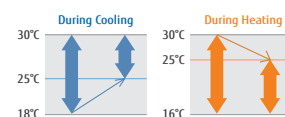

# Simple Remote Controller

UTY-RSNYM, UTY-RSKY/UTY-RHKY (Without operation mode)

SPLITS/MULTI/VRF



UTY-RSNYM  
UTY-RSKY

UTY-RHKY  
(Without operation mode)

## Compact remote controller provides access to basic functions

- Up to 16 indoor units can be controlled with one remote controller.
- Suitable for hotels or offices as it is easily operated with no complex functions.
- Backlight enables easy operation in a darkened room.
- 3-wire type

Max. Controllable

**16** indoor units

Max. Controllable

**1** Group

## Easy-to-use operation

- Provides access to basic operations, such as Start / Stop, Fan control, Operation mode switching, and Room temperature setting.
- A large On / Off button is provided in the centre of the remote controller for easy operation.
- Can be used jointly with another individual control unit.
- Following an error display, diagnostics can be carried out on the controller.

## Specifications

Model name	UTY-RSRY	UTY-RHRY	UTY-RSNYM, UTY-RSKY	UTY-RHKY
Power Source	DC 12 V	DC 12 V	DC 12 V	DC 12 V
Dimensions (H × W × D) (mm)	120 × 75 × 19.4	120 × 75 × 19.4	120 × 75 × 19.4	120 × 75 × 14
Weight (g)	120	120	120	90

DC 12 V is supplied by the indoor unit.

# MODBUS® Convertor for Indoor Unit

UTY-VMSX

## SPLITS/MULTI/VRF



Max. Connectable  
**1** Single indoor unit

The MODBUS Convertor allows a complete integration of air conditioners into MODBUS Networks.

- Simple installation due to small and compact size.
- No separate external power supply required.
- The MODBUS Convertor must be connected one by one within the indoor unit.
- The MODBUS Controller permits central monitoring and control of air conditioners from BMS/Central/Home Controller.

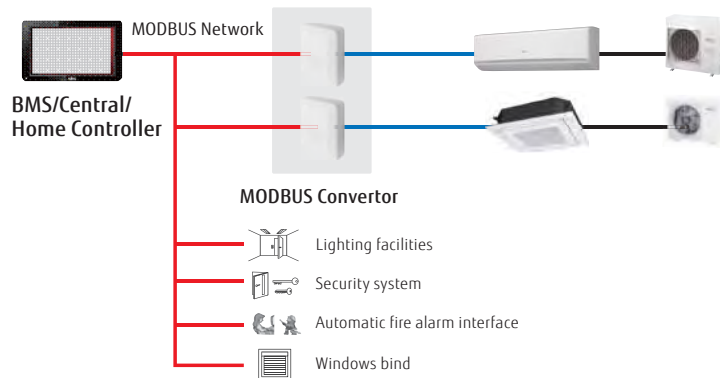

### Basic control

- Turning the units on and off
- Mode control (Heat, Cool, Dry, Auto, Fan)
- Fan speed setting
- Louvre position (Airflow direction setting)
- Room temperature setting and display
- Economy mode setting
- Error status

### Easy Installation

Flexible installation locations with neat wirings are feasible since no power supply cable is used in the convertor.

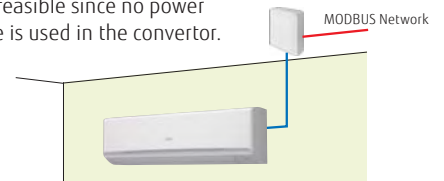

# KNX® Convertor for Indoor Unit

UTY-VKSX

## SPLITS/MULTI/VRF



Max. Connectable  
**1** Single indoor unit

KNX Convertor is useful for individual control of indoor.

- New KNX Convertor enables to connect central/home controller and Fujitsu General indoor unit.
- Compact and light weight design

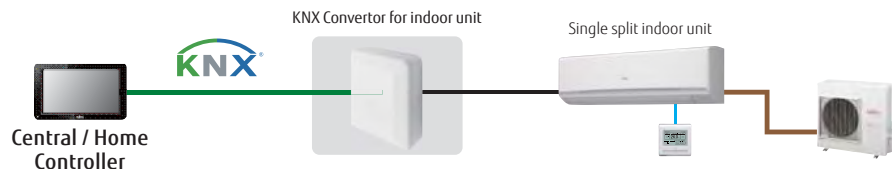

### Specifications

Model name	UTY-VMSX
Power supply	DC 12 V
Input Power (W)	Max. 1.2
Dimensions (H×W×D)(mm)	140 × 117 × 43
Weight (g)	200
Maximum Connectable indoor unit number per 1 MODBUS Convertor	1

### Modbus communication specifications

Transfer mode	RTU mode
Communication speed	9600/19200bps
Data bit	8
Parity	even/odd/none
Stop bit	1/2 (no parity)
Network	RS485
Maximum cable length	1000m (3280 ft)

Model name	UTY-VKSX
Power supply	DC 12 V
Power consumption (W)	0.6
Dimensions (H×W×D)(mm)	140 × 117 × 43
Weight (g)	215



# Wireless LAN Interface

UTY-TFNXZ1 / UTY-TFSXZ1, UTY-TFSXW1, UTY-TFSXF2

SPLITS/MULTI/VRF

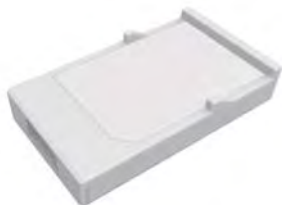

USB type for single split models  
UTY-TFSXF2

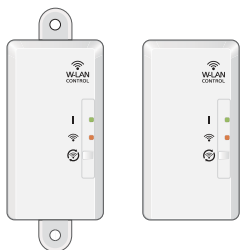

UTY-TFNXZ1  
UTY-TFSXZ1

UTY-TFSXW1

- Allows users to remotely manage an Air Conditioning system using all sort of mobile devices such as Smartphones, and tablets.
- No separate external power supply required
- Can be used for single indoor units and multi system indoor units

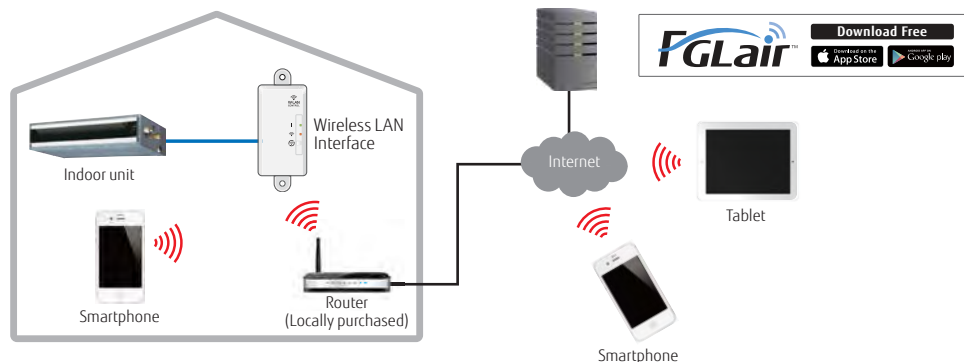

Max. Connectable

1 Single indoor unit

## Basic control

- Turning the units on and off
- Mode control (Heat, Cool, Dry, Auto, Fan)
- Fan speed setting
- Louvre position (Airflow direction setting)
- Timer operation setting (Weekly timer)
- Economy mode setting

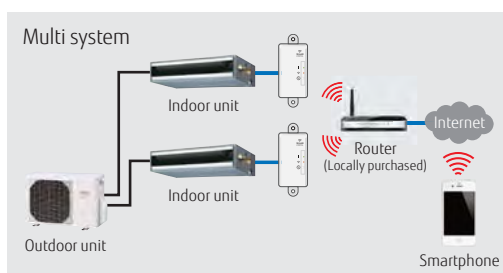

## Multiple air conditioning management

- Multiple air conditioning management at difference locations.

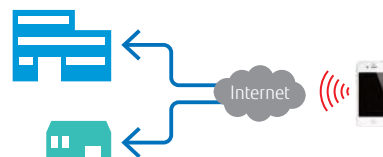

## Error display & E-mail notification

- Alerts e-mail notification
- Air conditioning malfunction display
- It enables rapid service response when error occurs.

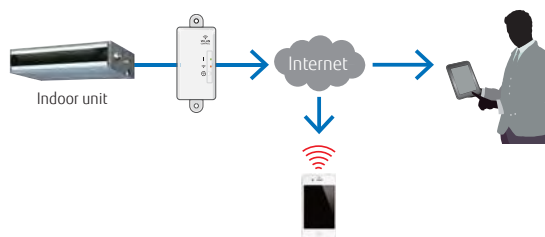

## Wireless LAN Interface (USB type) UTY-TFSXF2

New compact USB type is available. Specialised installation work is not required and it can be installed to indoor unit easily.



## Specifications

Model name	UTY-TFNXZ1 / UTY-TFSXZ1	UTY-TFSXW1	UTY-TFSXF2
Dimensions (H × W × D) (mm)	71 × 38 × 15	71 × 38 × 15	56.7 × 34 × 9.72
Weight (g)	35	35	30

# Wired Remote Controller

UTY-RVNYM

SPLITS/MULTI



## Hi-grade individual control using various functions.

- 3.7-inch LCD backlight screen.
- Supporting various Energy Saving functions with simple operation.
- Multiple Language Support.  
(English, German, French, Spanish, Russian, Portuguese, Italian, Greek, and Turkish)

Max. Controllable  
**16** indoor units

Max. Controllable  
**1** Group

## High visibility and Easy operation

- Icon display of effectual functions.
- Main functions in large icons: "Mode", "Set Temp", and "Fan".
- Easy to operate by Control guide display.
- Simple operation with easy 4-way navigation pad.

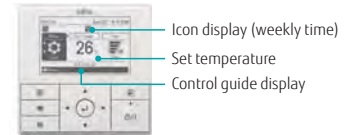

## High performance and compact size

- In addition to the individual control, various energy saving controls can be realised using only one remote controller.



## Various energy saving control

### Weekly Timer function

- Can be set up to 8 times per day (On/Off, mode, Temp)
- 2 pattern settings (i.e. Summer/Winter setting) are available.

### Auto OFF Timer

- Set Temperature Auto Return
- Set Temperature Upper and Lower Limit Setting

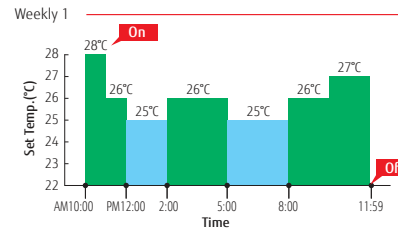

Setting menu in remote controller

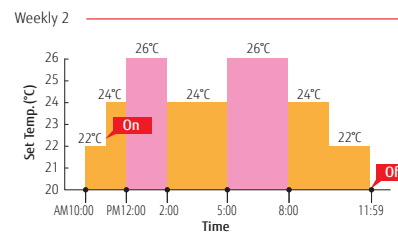
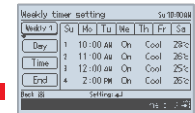

Setting menu in remote controller

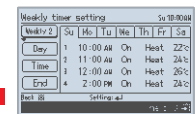

## Specifications

Model name	UTY-RVNYM
Power Source	DC 12 V
Dimensions (H x W x D) (mm)	120 x 120 x 21.3
Weight (g)	220

DC 12 V is supplied by the indoor unit.

# External Switch Controller

UTY-TERX

SPLITS/MULTI/VRF



Max. Controllable  
**1** group

## Air conditioner switching can be controlled by connecting other sensor switches

- In combination with a field supply Card-Key Switch or other sensor, the External Switch Controller allows control of the ON / OFF, Room temperature, Fan speed and Master control functions. This makes this product suitable for installations such as hotel rooms.
- Card-key or other sensor switches are available as a locally purchased parts.
- The set temperature can be specified at two points for cooling and heating individually (4 points).



### Specifications

Model name	UTY-TERX	
Power Supply	DC 6.5-16 V	
Dimensions (H × W × D) (mm)	140 × 117 × 43	
Weight (g)	250	

DC 12 V is supplied by the indoor unit.

# Wireless Remote Controller

UTY-LNTY

SPLITS/MULTI



Max. Controllable  
**16** indoor units

Max. Controllable  
**1** Group

Selectable  
**4** daily timers

## Simple and sophisticated operations with a choice of 4 daily timers

- A single controller controls up to 16 indoor units.

### Built-in timers

4 timer programs: On / Off / Program / Sleep

Program timer: Operates ON/OFF timer once within 24 hours

Sleep timer: Corrects the set temperature automatically during sleep time

### Easy installation and operation

Code selector switch prevents indoor unit mix-up (up to 4 codes)

Wide and precise transmitting range

### Specifications

Model name	UTY-RNNYM	UTY-LNTY
Power Source	DC 12 V	DC5V
Dimensions (H × W × D) (mm)	120 × 120 × 18	145 × 90 × 30
Weight (g)	160	150

DC 12 V is supplied by the indoor unit.

## IR Receiver Unit for Duct

UTY-LRHYM, UTY-LBTYM

SPLITS/MULTI

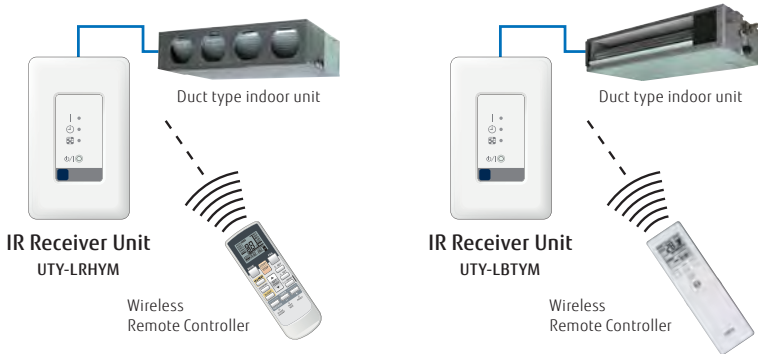

Duct type indoor units can be controlled with Wireless Remote Controller

## IR Receiver Unit for Cassette

UTY-LRHYA2, UTY-LBTYC

SPLITS/MULTI



Cassette type indoor unit can be controlled with Wireless Remote Controller

## IR Receiver Unit for Ceiling

UTY-LBTYH

SPLITS/MULTI

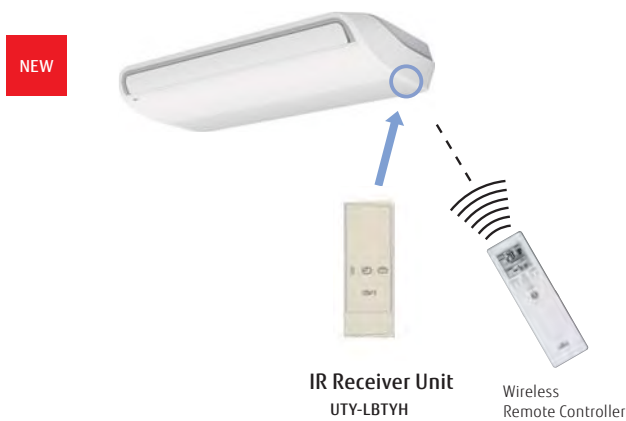

Ceiling type indoor unit can be controlled with Wireless Remote Controller

### Specifications

Model name	UTY-LRHYM	UTY-LBTYM	UTY-LRHYA2	UTY-LBTYC	UTY-LBTYH
Battery	DC5V	DC5V	DC5V	DC5V	DC5V
Dimensions (H × W × D) (mm)	145 × 90 × 30	145 × 90 × 30	193.9 × 193.9 × 31.2	193.9 × 193.9 × 31.2	174.8 × 48.6 × 23.1
Weight (g)	150	150	140	140	TBA

DC 12 V is supplied by the indoor unit.

# Central Remote Controller

UTY-DMMYM

MULTI



Max. Controllable  
**1** multi system

Max. Controllable  
**6** indoor units

## For 5-unit, 6-unit, multi-split type

- Batched control of up to 8 indoor units. The temperature, airflow volume, and remote control prohibition settings of all indoor units can be batched.
- Corresponds to 9 different languages (English, German, French, Spanish, Russian, Portuguese, Italian, Greek, and Turkish)
- Large backlight LED screen
- Large easy-to-see operation panel

### System configuration

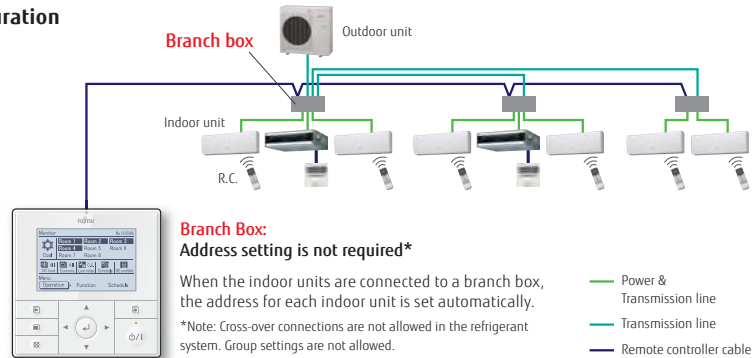

## Central Remote Controller Functions

### Weekly schedule timer

The ON/OFF setting can be set for 4 times a day. Two weekly patterns can be set to match the cooling and heating seasons.

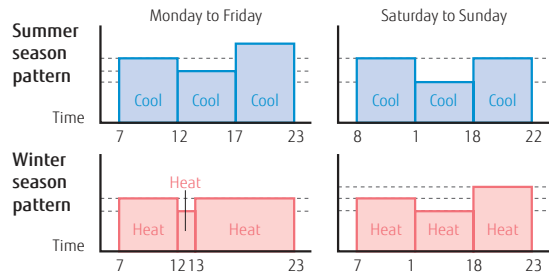

### Low noise operation

Users can choose from 4 low noise levels, depending on the installation environment. The operation time can be set using the timer.

### 10°C heat operation

When you leave, minimum heating operation is performed to maintain the room temperature (maintain at 10°C).

### Economy operation

Economy operation is energy saving, as the set temperature of indoor unit is shifted by 1°C and the maximum electric value of the outdoor unit is suppressed.

### Prohibited Settings

The remote controller operation of all indoor units comes with a lock function to prevent unapproved operations in the various rooms. The central remote controller also has a key lock function to prevent children from playing with it, etc.

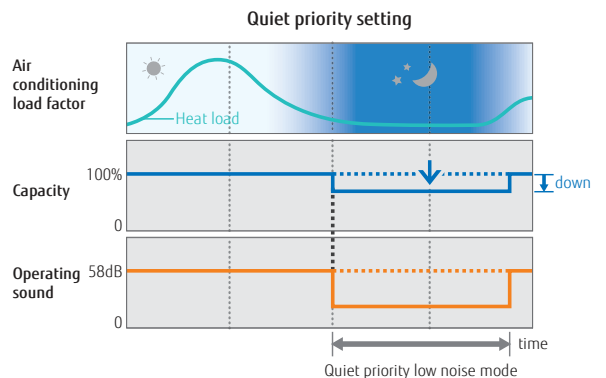

## Specifications

Model name	UTY-DMMYM
Power Source	DC 12 V
Dimensions (H × W × D) (mm)	120 × 120 × 21.3
Weight (g)	220

DC 12 V is supplied by the indoor unit.

# MODBUS® Interface

FJ-RC-MBS-1

SPLITS/MULTI



The MODBUS Interface allows a complete integration of air conditioners into MODBUS Networks.

- Simple installation due to small and compact size.
- No separate external power supply required.
- The MODBUS Interface permits central monitoring and control of air conditioners from BMS.

Max. Connectable

1 Single indoor unit

Max. Controllable

1 Group

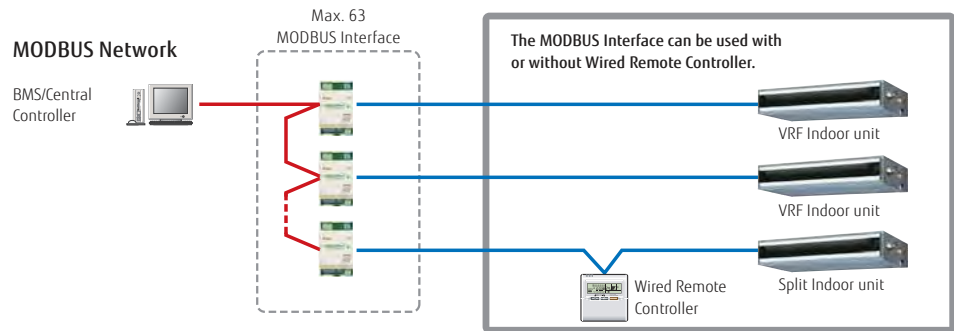

# KNX® Interface

FJ-RC-KNX-1i

SPLITS/MULTI



The KNX Interface allows a complete integration of air conditioners with KNX Network systems.

- Simple installation due to small and compact size.
- No separate external power supply required (just KNX bus power).
- Can be used for single indoor unit and group controlled (up to 16) indoor units.

Max. Connectable

1 Single indoor unit

Max. Controllable

1 Group

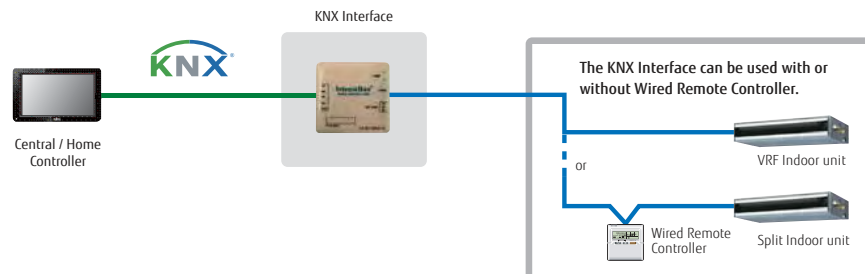

## Specifications

Model name	FJ-RC-MBS-1	FJ-RC-KNX-1i
Dimensions (H × W × D) (mm)	93 × 53 × 58	70 × 70 × 28
Weight (g)	85	70

# Wireless LAN Interface

FJ-RC-WIFI-2, FJ-IR-WIFI-1, FJ-AC-WIFI-1

SPLITS/MULTI



Max. Connectable

1 Single indoor unit

Max. Controllable

1 Group



- It is the most advanced solution to remotely manage an Air Conditioning system using all sort of mobile devices such as Smartphones, Tablets and PC
- No separate external power supply required
- Can be used for single indoor unit and group controlled (up to 16) indoor units

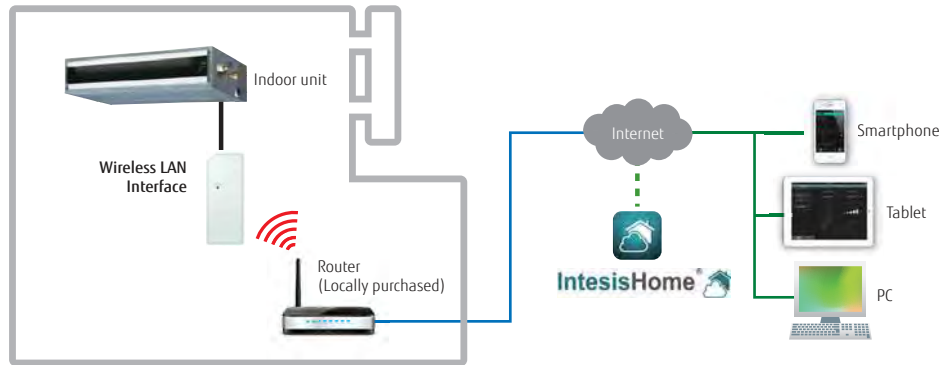

- **FJ-IR-WIFI-1** - IR version compatible with most AC units with an IR wireless remote controller
- **FJ-RC-WIFI-2** - Compatible with most 3-wire remote controller models
- **FJ-AC-WIFI-1** - Compatible with CN6 / CN65 R410A and R32 models

## Basic control

- Alexa, Google, IFTTT Compatible
- Turning the units on and off
- Mode control (Heat, Cool, Dry, Auto, Fan)
- Fan speed setting
- Louvre position (Airflow direction setting)
- Room temperature display
- Set temperature control
- Multi Language
- One Scene and Timer



(Application screen image)

## Advanced control (Optional functions)

- Climate working modes (ECO, Comfort, Powerful) (future release)
- Schedule functions (ON/OFF, Modes, Set point temperature, Fan Speed, Louvre position)
- Set temperature limitation (future release)
- Multiple Scenes & Timers and Calendar function

## Notifications and history

- Alerts e-mail notification (future release)
- Air conditioning malfunction alerts
- Connectivity monitoring and alerts
- History (future release)

## Specifications

Model name	FJ-RC-WIFI-1	FJ-IR-WIFI-1	FJ-AC-WIFI-1
Dimensions (H × W × D) (mm)	108 × 70 × 28		
Weight (g)	80		

# Network Converter for Single Split

UTY-VTGX / UTY-VTGXV

SPLITS/MULTI



UTY-VTGX  
DC power supply type

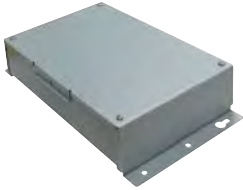

UTY-VTGXV  
AC power supply type

- The network converters are required when connecting single split system to VRF network system.
- Compact and light weight design
- Connectable to both types of 2-wire and 3-wire remote controllers

## Installation example.

- 2 types of 1 remote controller type and 2 remote controllers type are available.
- Power supply (AC220-240V, 50/60 Hz) is required for 2 remote controllers type.

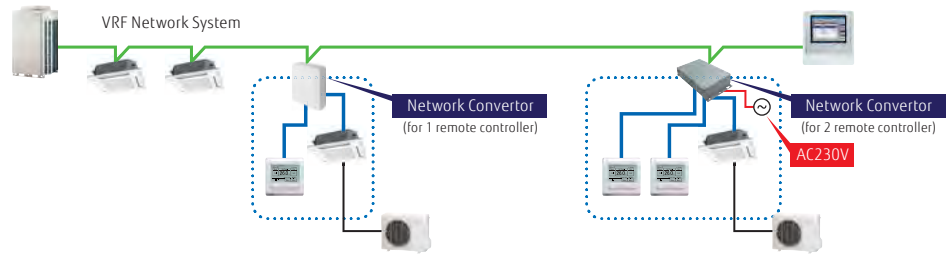

Max. Controllable  
**16**  
single indoor units

Max. Controllable  
**1** Group

Max. Controllable  
**100**  
Network Convertors

- 2-wire and 3-wire type of the wired remote controller can be connectable.

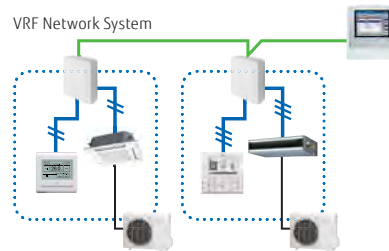

- A central control can be provided for the single split systems. (Up to 100 units of Network Converter is connectable in one VRF network system)

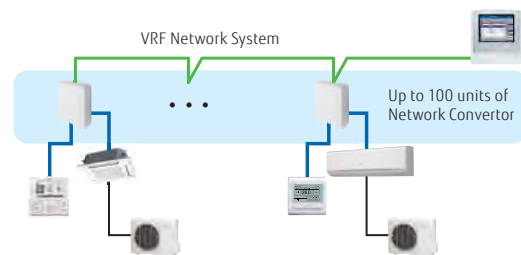

## Specifications

Model name	UTY-VTGX		UTY-VTGXV
	Power Supply	polar 3-wire DC 12 V	non-polar 2-wire DC 12 V
Input power (W)	Max. 1.2		Max. 3
Dimensions (H × W × D) (mm)	140 × 117 × 43		54 × 260 × 150
Weight (g)	250		1,100



# Wireless Remote Controller

UTY-LNHY

VRF



Max. Controllable  
**16** indoor units

Max. Controllable  
**1** Group

Selectable  
**4** daily timers

## Simple and sophisticated operations with a choice of 4 daily timers

- A single controller controls up to 16 indoor units.

### Built-in timers

- 4 timer programs: On / Off / Program / Sleep
- Program timer: Operates ON/OFF timer once within 24 hours
- Sleep timer: Corrects the set temperature automatically during sleep time

### Easy installation and operation

- Code selector switch prevents indoor unit mix-up (up to 4 codes)
- Wide and precise transmitting range

## IR Receiver Unit for Duct

UTB-YWC, UTY-TRHX

VRF

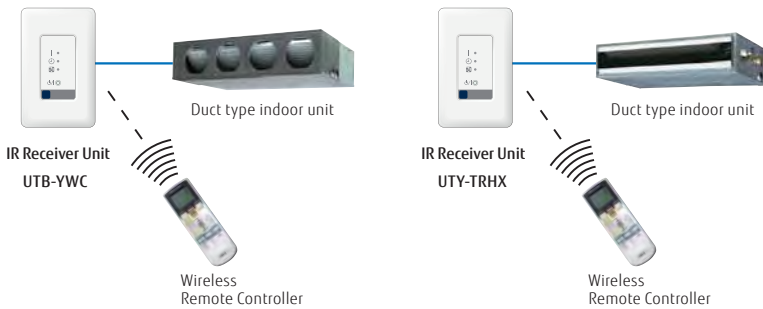

Duct type indoor units can be controlled with Wireless Remote Controller

\*The wireless remote controller (Model: UTY-LNHY) is necessary separately

## IR Receiver Unit for Cassette

UTY-LRHYB1, UTY-LBHDX, UTY-TRHX

VRF

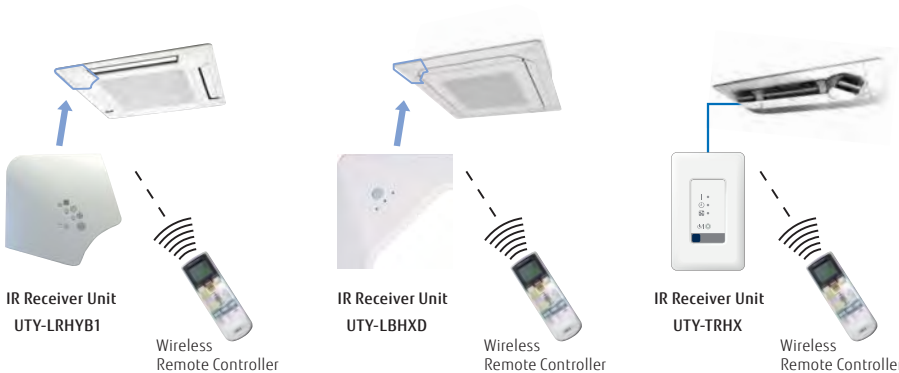

Cassette type indoor unit can be controlled with Wireless Remote Controller

\*The wireless remote controller (Model: UTY-LNHY) is necessary separately

### Specifications

Model name	UTY-LNHY	UTB-YWC	UTY-LRHYB1	UTY-LBHDX	UTY-TRHX
Battery	1.5 V (R03 / LR03 / AAA)×2	DC 5 V	DC5V	DC5V	DC 5 V
Dimensions (H × W × D) (mm)	170 × 56 × 19	145 × 90 × 30	193.9 × 193.9 × 31.2	193.9 × 193.9 × 31.2	145 × 90 × 30
Weight (g)	85	150	140	140	150

DC 12 V is supplied by the indoor unit.

# Central Remote Controller

UTY-DCGYZ1

VRF



## For small- and medium-sized buildings and tenants

- Individual control and monitor of 100 indoor units
- 7.0inch TFT colour screen
- High visibility and easy operation
- Supports 12 different languages (English, Spanish, German, French, Italian, Russian, Portuguese, Turkish, Polish, Greek, Dutch, Chinese)

Max. Controllable  
**100** indoor units

Max. Controllable  
**50** groups

## Easy operation

- The new central remote controller realised an intuitive operation feeling by touch panel operation.
- All functions can be accessed from the top display and the following operations are displayed at pop-up window.

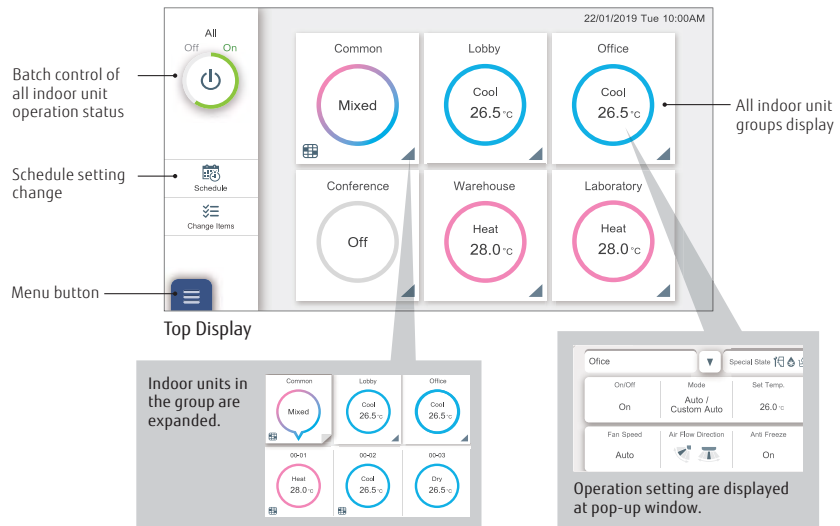

## Trouble support function

### Display error details

Display descriptive explanation when an error occurs

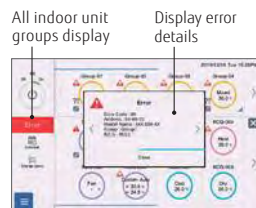

### Sensor value monitoring function

Monitor sensor data of indoor unit / outdoor unit, send mail

### Notify room temperature by email\*

Notify by e-mail when the temperature around the air conditioner is too high or too low

\*:This function is available only when using wired remote controller.

## Remote monitoring / Remote operation

New central remote controller can control your tenant's air conditioner anytime and anywhere.

### Example

- Control / Monitoring Fujitsu air conditioner
- Error notification by E-mail

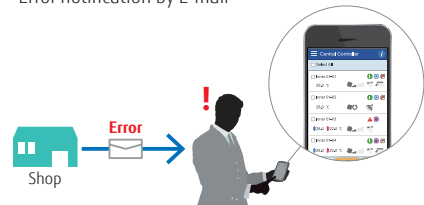

## Specifications

Model name	UTY-DCGYZ1	
Power Supply	100-240 V 50/60 Hz	
Dimensions (H × W × D) (mm)	134.6 × 216.2 × 37.9	
Weight (g)	800	

# Touch Panel Controller

UTY-DTGYZ1

VRF



- Large-sized 7.5-inch TFT colour
- LCD Easy finger touch operation
- Stylish shape and design to suit all applications
- Up to 400 indoor units can be controlled
- Selectable 2 display types (Icon / List) in monitoring mode
- Supports 7 different-languages ,English, Chinese, French, German, Spanish, Russian, Polish.
- Mounted with LAN interface for remote control & operation, external input / output with emergency stop and batch ON / OFF

Max. Controllable  
**400** indoor units

Max. Controllable  
**100** outdoor units

Max. Controllable  
**400** groups

## Easy Operation

- Wide range of simple-to-understand icons
- Operation can be selected using your finger or the dedicated touch pen by pressing the appropriate on-screen icon.
- Back colour identifies current control operation blue for monitoring, green for operational control.

## Easy maintenance

- Flat touch screen is easily cleaned
- Non-glare coating on touch panel controller minimises fingerprint marking
- Easy-to-remove front cover

## Easy installation

- Touch Panel Controller is easily mounted to the wall.
- Flat back surface allows to be installed wherever it is needed.
- No additional component is required for installation



## Electricity charge apportionment

(Option: UTYPGXA only compatible with UTYDTGYZ1)

- Electricity charge apportionment can be performed easily for the power consumed when billing users for air conditioning power charges.

- Apportionment charge/bill calculation
- Tenant (block) setting
- Common facilities apportionment setting
- Rated power consumption allotment setting
- Individual calculation at cooling and heating
- Electricity meter supported

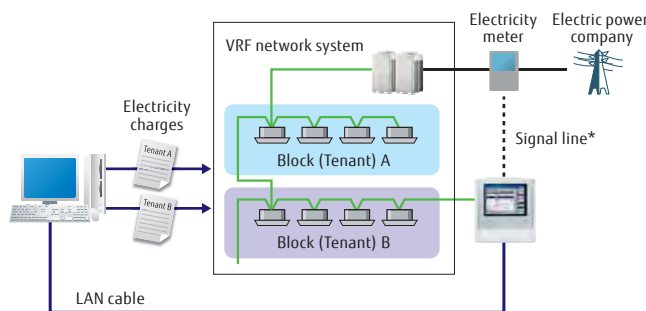

\*: Electricity meter (1unit) can be connected to external input connector of the TPC unit. In this case, electricity meter cannot be connected to outdoor unit simultaneously.

## Up to 400 indoor units can be controlled

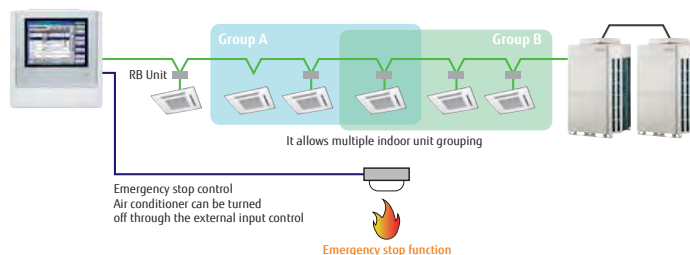

## Specifications

Model name	UTYDTGYZ1
Power Supply	100-240 V 50/60 Hz, Single phase
Dimensions (H x W x D) (mm)	260 x 246 x 54
Weight (g)	2,150
Interface	Transmission/LAN/USB/EXT IN/EXT OUT/Reset SW

# System Controller

UTY-APGXZ1 **Software**

Max. Controllable  
**4** VRF network systems

Max. Controllable  
**400** outdoor units

Max. Controllable  
**1,600** indoor units

VRF



System Controller realises the advanced integrated monitoring & control of VRF network system from small scale buildings to large scale buildings.

- Up to a maximum of 4 VRF network systems, 1600 indoor units, and 400 outdoor units can be controlled.
- In addition to air conditioning precision control function, central remote control, electricity charge calculation, schedule management, and energy saving functions are strengthened and building manager and owner needs are met.
- Corresponds to 7 different languages (English, Chinese, French, German, Spanish, Russian, Polish)

# System Controller Lite

UTY-ALGXZ1 **Software**

Max. Controllable  
**1** VRF network systems

Max. Controllable  
**100** outdoor units

Max. Controllable  
**400** indoor units

VRF



System Controller Lite has standard functions sufficient for air conditioner management in small and medium scale buildings .

- Up to a maximum of 1 VRF network system, 400 indoor units, and 100 outdoor units can be controlled.
- In addition to air conditioning precision control function, a variety of management software is available as an option to give customers a wide range of choice.
- Corresponds to 7 different languages (English, Chinese, French, German, Spanish, Russian, Polish)

## High visibility and Easy operation

**Click & Operate:** The property is shown visually from the perspective most suitable for operation and operated accordingly (Click & Operate). You can select from among the 4 displays of site, building, floor, or list.

**Freely define groups for batched control:** Indoor units can be freely grouped for simple batched control from a tree menu. Grouping by hierarchal structure, such as by section, division or department is possible.

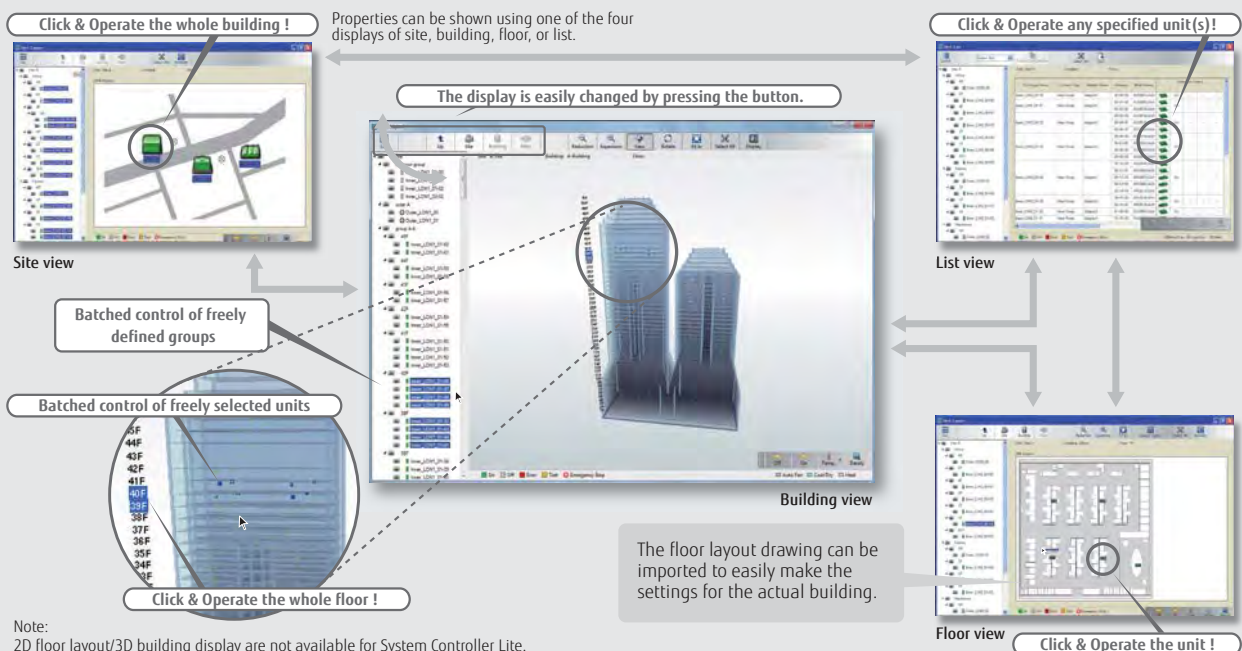

### 3rd party devices connected by Modbus can be controlled.

**Standard** for System Controller **Option** for System Controller Lite UTY-PLGXX2

When Modbus Adaptor (locally purchased) is connected to PC, the electric facilities supported by Modbus can be controlled centrally. By using Modbus wasted electricity charge can be reduced in the entire building.

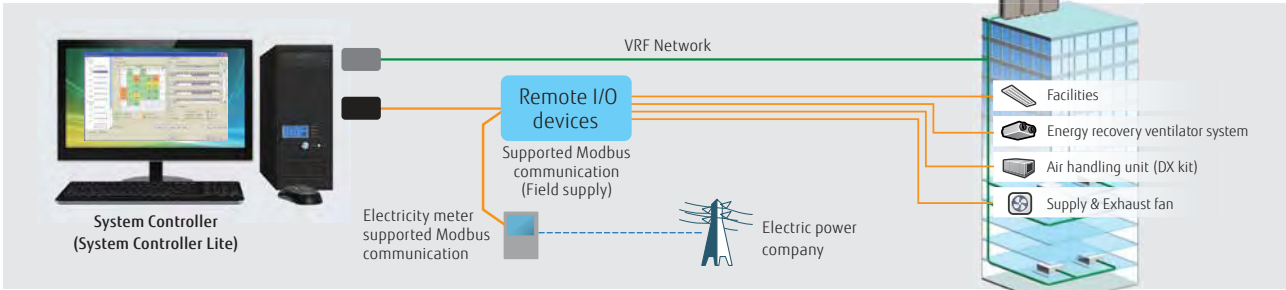

### Diverse operation management & Data management

**Standard** for System Controller and System Controller Lite

#### Schedule management

- Annual schedules can be set for each remote controller group / user defined group.
- Start / stop, operating mode, remote controller prohibition, and temperature settings can be set up to 143 times per day at 10 minute intervals for up to 101 configurations for each remote controller group.
- Settings can be made for periods straddling midnight.
- Allows programming of special settings for holidays, including public holidays, for a complete year.
- Low noise operation of outdoor unit can be scheduled.

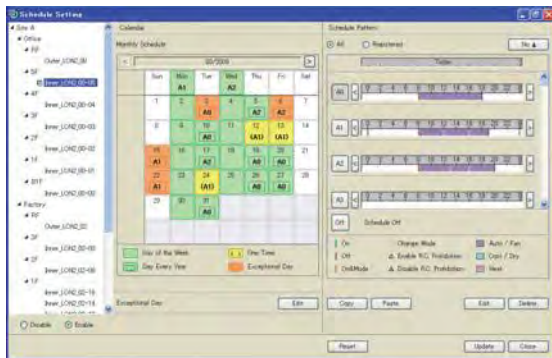

#### Diverse control of indoor unit and outdoor unit

- Indoor unit operation state, operation mode, etc. are displayed
- Indoor unit start / stop and operation mode switching
- Room temperature set point limitation
- Outdoor unit low noise setting

#### Remote controller prohibition

This prohibits changes to the operation mode, temperature, start/stop, etc.

#### Error display & E-mail notification

Error is notified with popup message, audible sound and E-mail real time when error occurs. Errors for the past 1 year are logged and can be reviewed later.

#### Operating & control record

Displays the history of operation status and control.

#### Data base import/export

Imports/exports registration data, layout data, and image data. Only the administrator can make this setting.

#### Automatic clock adjustment

The time setting of each controller can be set in batch automatically.

### Electricity charge apportionment

**Standard** for System Controller

**Option** for System Controller Lite UTY-PLGXA2

#### Electricity charge apportionment calculation framework

Suppose you want to find the power consumed by the air conditioners for each tenant. With the electricity charge apportionment function, the used energy ratio will be provided, calculating in detail the energy consumed by the units used by each tenant. This information is then used to calculate the charges for the electricity consumed by air conditioning for each tenant by using the electricity bill provided by the power company

(See figure at right)

The detailed calculation takes into consideration such things as unused rooms and nighttime electricity charges and shows them in a charges calculation sheet.

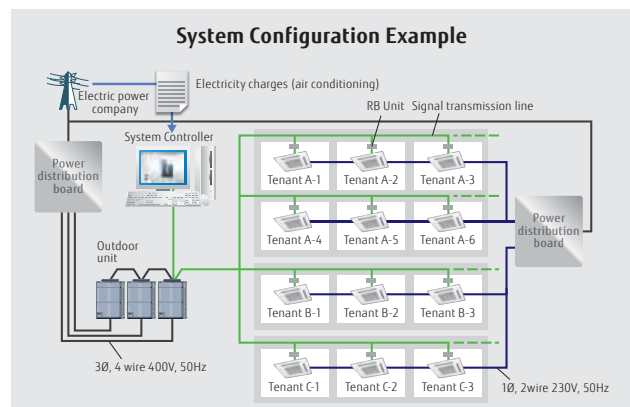

Features: System Controller/System Controller Light

### Remote management

- Standard** for System Controller
- Option** for System Controller Lite UTY-PLGXR2

System Controller may be used on site or remotely over various networks for remote central control. System Controller requires 2 software working together. VRF Controller runs on site and communicate with VRF system. VRF Explorer runs remotely and provides user interface and communicate with the VRF Controller. VRF Controller and VRF Explorer program may run in a single PC or in different PCs separated by network. By using VRF Explorer software, one PC can perform central control of 10 VRF system sites with max. 20 buildings per site.

#### On site central control

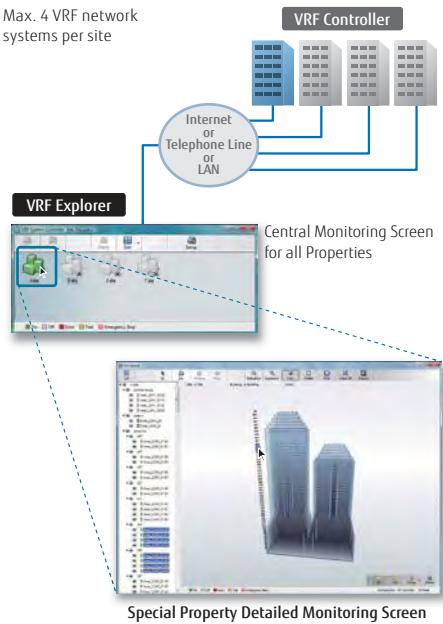

#### Remote central control

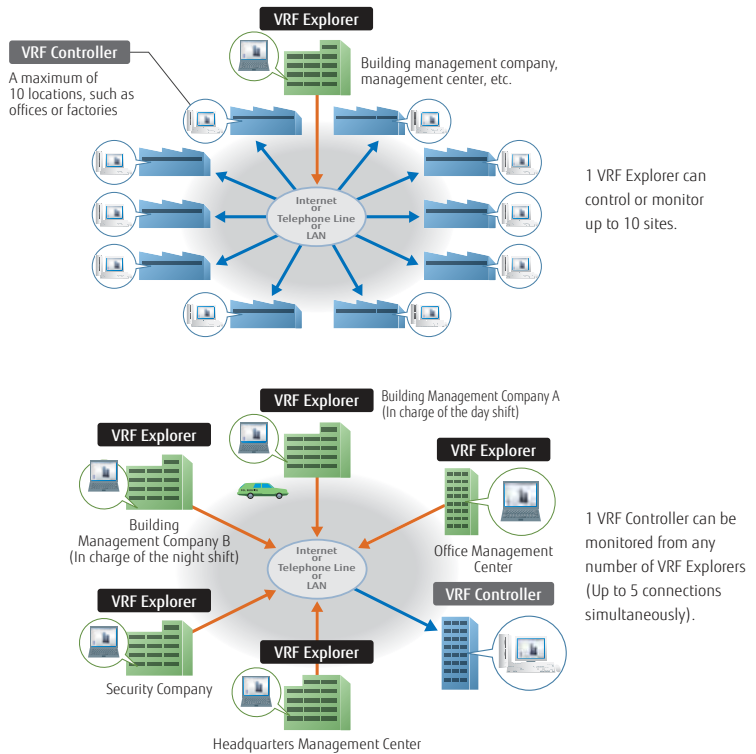

### Energy saving management

- Option** for System Controller UTY-PEGXZ1
- Option** for System Controller Lite UTY-PLGXZ2

A variety of energy saving operations can be set and managed depending on the season, weather, and time period. Excellent energy saving operation is performed while keeping users comfortable.

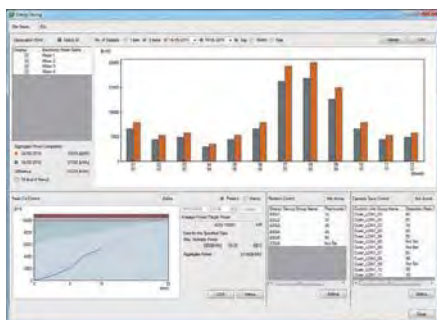

Energy Saving Management Main Screen

Energy saving graph data: This graph compares the electricity consumption with the previous month and previous year to make it easy to analyse the energy saving effect.

#### Indoor unit rotation operation

The operation of indoor units can be automatically rotated within a group in accordance with the set annual schedule to reduce power consumption while maintaining comfort. The indoor unit operation stoppage rate can be selected.

#### Peak cut operation

A power meter is connected to detect the total power consumption while shifting the indoor unit set temperature, set the indoor unit forced thermostat off, and taking other measures to carefully control the power consumed while maintaining comfort and conducting control to maintain the target power consumption set for each time. The indoor units to be controlled can be freely grouped and the control level can be set.

#### Outdoor unit capacity save

Outdoor unit capacity save switches the outdoor unit capability upper limit to suppress power consumption during hot summers and cold winters by averaging the power saving effect of each refrigerant system. You can select from 50% or more of the capacity upper limit.

## FUNCTIONS SUMMARY

Function	Type	System controller			System controller lite			
		UTY-APGXZ1	Option UTY-PEGXZ1	UTY-ALGXZ1	Option UTY-PLGXR2	Option UTY-PLGXA2	Option UTY-PLGXE2	Option UTY-PLGXX2
System specification	Max. VRF networks supported	4	—	1	—	—	—	—
	Max. indoor unit / remote controller groups per VRF network	400	—	400	—	—	—	—
	Max. outdoor units per VRF network	100	—	100	—	—	—	—
	Max. indoor units / remote controller groups per System controller	1600	—	400	—	—	—	—
	Max. outdoor units per System controller	400	—	100	—	—	—	—
Site supervision	Multi site display	10	—	10	—	—	—	—
	Number of building / 1 site	20	—	—	—	—	—	—
	Number of floor per 1 site	200	—	—	—	—	—	—
	Number of floor per 1 building	50	—	—	—	—	—	—
	3D graphical layout view	●	—	—	—	—	—	—
	2D graphical layout view	●	—	—	—	—	—	—
	List display	●	—	●	—	—	—	—
	Tree display	●	—	●	—	—	—	—
Error management	Group display	●	—	—	—	—	—	—
	Error notification	●	—	●	—	—	—	—
	Audible alarm	●	—	●	—	—	—	—
History	Error e-mail notification	●	—	●	—	—	—	—
	Error history	●	—	●	—	—	—	—
	Operation history	●	—	●	—	—	—	—
Operation control	Individual control	Control history	●	—	●	—	—	—
		On/Off	●	—	●	—	—	—
		Operation mode*	●	—	—	—	—	—
		Room temperature	●	—	●	—	—	—
		Fan speed	●	—	●	—	—	—
		Air flow direction	●	—	●	—	—	—
		Economy mode	●	—	●	—	—	—
		Room temperature set point limitation	●	—	●	—	—	—
	Individual management	Antifreeze	●	—	●	—	—	—
		Outdoor unit low noise setting	●	—	●	—	—	—
		Remote control prohibition setting	●	—	●	—	—	—
	Other	Temperature upper and lower limit setting	●	—	●	—	—	—
		Filter sign reset	●	—	●	—	—	—
		Memory operation	●	—	●	—	—	—
	Schedule	Pattern operation	●	—	●	—	—	—
		Annual Schedule	●	—	●	—	—	—
		Special day setting	●	—	●	—	—	—
On / off per day		72	—	72	—	—	—	
On / off per week		504	—	504	—	—	—	
Day off		●	—	●	—	—	—	
Min. unit of timer setting (Minutes)		10	—	10	—	—	—	
Remote management	Low noise mode Weekly schedule	●	—	●	—	—	—	
	Web Operation	●	—	●	—	—	—	
	Remote monitoring	●	—	—	●	—	—	
Electricity charge apportionment	Remote operation control	●	—	—	●	—	—	
	Remote function setting	●	—	—	●	—	—	
	Apportionment charge/bill calculation	●	—	—	—	●	—	
	Tenant (block) setting	●	—	—	—	●	—	
	Common facilities apportionment setting	●	—	—	—	●	—	
	Rated power consumption allotment setting	●	—	—	—	●	—	
Energy saving management	Individual calculation at cooling and heating	—	●	—	—	—	—	
	Electricity meter supported	—	●	—	—	—	●	
	Indoor unit rotation	—	●	—	—	—	●	
	Peak cut control	—	●	—	—	—	●	
	Outdoor unit capacity save	—	●	—	—	—	●	
	Record of energy saving operation	—	●	—	—	—	●	
	Energy saving information	—	●	—	—	—	●	
External Device Control	Power consumption monitor	—	●	—	—	—	●	
	Electricity meter supported	—	●	—	—	—	●	
	Monitor	●	—	—	—	—	—	
Others	Control	●	—	—	—	—	—	
	Database import/export	●	—	●	—	—	—	
	Automatic clock adjustment	●	—	●	—	—	—	
	Multi language	7 languages	—	7 languages	—	—	—	
	Refrigerant leakage detection function	●	—	●	—	—	—	
	Power shutdown	●	—	●	—	—	—	

●●: Available. - : Not available.

### Personal computer system requirements

The required PC specifications are shown in the following table.

	System Controller	System Controller Lite
Operating system	<ul style="list-style-type: none"> <li>• Microsoft® Windows® 7 Home Premium (32-bit or 64-bit) SP1, Windows® 7 Professional (32-bit or 64-bit) SP1</li> <li>• Microsoft® Windows® 8.1 (32-bit or 64-bit), Windows® 8.1 Pro (32-bit or 64-bit)</li> <li>• Microsoft® Windows® 10 Home (32-bit or 64-bit), Windows® 10 Pro (32-bit or 64-bit)</li> </ul> [Supported languages] English, Chinese, French, German, Russian, Spanish, and Polish	
CPU	Intel® Core™ i3 2 GHz or higher	
Memory	<ul style="list-style-type: none"> <li>• 2 GB or more (for Windows® 7 [32-bit])</li> <li>• 4 GB or more (for Windows® 7 [64-bit], Windows® 8.1, and Windows® 10)</li> </ul>	
HDD	40 GB or more of free space	
Display	1024 x 768 or higher resolution	
Interface	<ul style="list-style-type: none"> <li>• Ethernet port (for getting access to the Internet using LAN) or Modem (for getting access to the Internet using Public Telephone Line)</li> <li>• USB ports (Maximum of 6 ports)</li> </ul> (Required only for the Server PC that works as VRF Controller) - Maximum of 2 USB ports are required for WHITE-USB-KEY/WibuKey connection - Maximum of 4 USB ports are required for Echelon® U10 USB Network Interface * Maximum number of required USB port depends on the applicable system configuration.	<ul style="list-style-type: none"> <li>• Ethernet port (for getting access to the Internet using LAN) or Modem (for getting access to the Internet using Public Telephone Line)</li> <li>• USB ports (Maximum of 6 ports)</li> </ul> (Required only for the Server PC that works as VRF Controller) - Maximum of 4 USB ports are required for WHITE-USB-KEY/WibuKey connection - 1 USB port is required for Echelon® U10 USB Network Interface * The maximum number of required USB port depends on the applicable system configuration.
Graphic accelerator	Microsoft® DirectX® 9.0c compatible	
Software	Adobe® Reader® 9.0 or later	

• Echelon® U10 USB Network Interface - TP/FT-10 Channel (Model number: 75010R) (Required for each VRF Network.)

### PACKING LIST

Type	For System controller			For System controller Lite			
	System Controller	Option Energy manager	System Controller Lite	Remote access	Option Electricity charge apportionment	Energy saving	Central Control
Model name	UTY-APGXZ1	UTY-PEGXZ1	UTY-ALGXZ1	UTY-PLGXR2	UTY-PLGXA2	UTY-PLGXE2	UTY-PLGXX2
WHITE-USB-KEY	1	1	1	1	1	1	1

\*1: Software protection key to be inserted in a USB slot running System Controller or System Controller Lite.

System Controller or System Controller Lite may only run on a PC with WHITE-USB-KEY. However, WHITE-USB-KEY is not required for remote VRF Explorer software.

# BACnet® Gateway

UTY-ABGXZ1 Software

# VRF



**WHITE-USB-KEY**  
(Software Protection Key)



BACnet is a registered trademark of ASHRAE. ASHRAE does not endorse, approve or test products for compliance with ASHRAE standards. Compliance of listed products to the requirements of ASHRAE Standard 135 is the responsibility of BACnet International (BI). BTL is a registered trademark of BACnet International.

- It is possible to connect medium to large sized BMS to VRF network system via BACnet®, a global standard for open networks.
- A maximum of 1600 indoor units with 4 VRF network systems (a maximum of 400 indoor units & 100 outdoor units for one network system) can be connected to one BACnet® Gateway.
- It is possible to control or monitor VRF network system from BMS via BACnet® Gateway.
- Compatible with BACnet® (ANSI / ASHRAE-135-2014) application specific controller (B-ASC).
- Compatible with BACnet®/IP over Ethernet.
- Scheduling function, Alarm & Event functions as well as Electricity Change Apportionment function are provided in BACnet® Gateway.
- Connection between VRF network system to personal computer is possible via small U10 USB interface. However, both U10 USB interface & personal computer are field supplied items.
- Corresponds to 7 different languages, English, Chinese, French, German, Spanish, Russian, Polish.

Max. Controllable

**4**

VRF network systems

Max. Controllable

**400**

outdoor units

Max. Controllable

**1,600**

indoor units

## Installation example

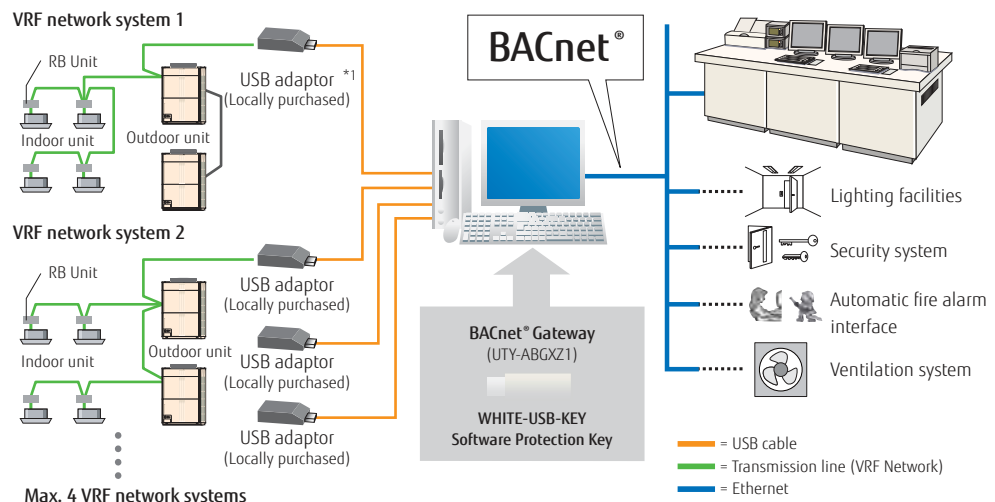

\*1: USB adaptor is U10 USB Network Interface of Echelon® Corporation.

## Personal computer system requirements

UTY-ABGXZ1	
Operating system	<ul style="list-style-type: none"> <li>• Microsoft® Windows® 7 Home Premium (32-bit or 64-bit) SP1, Windows® 7 Professional (32-bit or 64-bit) SP1</li> <li>• Microsoft® Windows® 8.1 (32-bit or 64-bit), Windows® 8.1 Pro (32-bit or 64-bit)</li> <li>• Microsoft® Windows® 10 Home (32-bit or 64-bit), Windows® 10 Pro (32-bit or 64-bit)</li> </ul> [Supported languages] English, Chinese, French, German, Russian, Spanish, and Polish
CPU	Intel® Core™ i3 2 GHz or higher
Memory	<ul style="list-style-type: none"> <li>• 2 GB or more (for Windows® 7 [32-bit])</li> <li>• 4 GB or more (for Windows® 7 [64-bit], Windows® 8.1, and Windows® 10)</li> </ul>
HDD	40 GB or more of free space
Display	1024 x 768 or higher resolution
Interface	<ul style="list-style-type: none"> <li>• Ethernet port (for getting access to the Internet using LAN)</li> <li>• USB ports (Maximum of 5 ports)                             <ul style="list-style-type: none"> <li>- 1 USB port is required for WHITE-USB-KEY/WibuKey connection</li> <li>- Maximum of 4 USB ports are required for Echelon® U10 USB Network Interface</li> </ul> </li> </ul> * Maximum number of required USB ports depends on the applicable system configurations.
Software	Adobe® Reader® 9.0 or later

• Echelon® U10 USB Network Interface – TP/FT-10 Channel (Model number: 75010R) (Required for each VRF Network.)

## <Packing list>

Name and shape	Quantity	Application
WHITE-USB-KEY	1	Includes the software and manuals, license for BACnet® Gateway.



# BACnet® Gateway

UTY-VBGX **Hardware**

VRF



BACnet is a registered trademark of ASHRAE. ASHRAE does not endorse, approve or test products for compliance with ASHRAE standards. Compliance of listed products to the requirements of ASHRAE Standard 135 is the responsibility of BACnet International (BI). BTL is a registered trademark of BACnet International.

- BACnet® Gateway enables to connect a BMS and Fujitsu General VRF system.
- A maximum of 128 indoor units and 32 refrigerant system can be connected to a single BACnet® Gateway.
- Compatible with BACnet® (ANSI / ASHRAE-135-2012) application specific controller (B-ASC).
- Compatible with BACnet®/IP over Ethernet.

Max. Controllable  
**1** VRF network system

Max. Controllable  
**32** refrigerant systems

Max. Controllable  
**128** indoor units

## Installation example

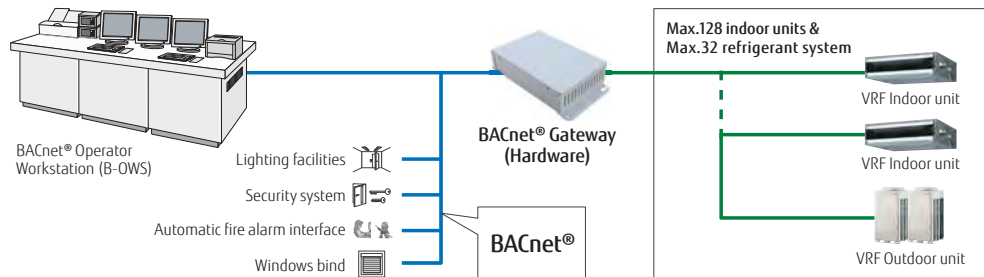

### Specifications

Model name	UTY-VBGX
Number of controllable indoor units	128
Number of controllable refrigerant system	32
Number of controllable VRF network	1
Number of connectable units / one VRF network	4

Model name	UTY-VBGX
Power Supply	Single phase, 100-240V, 50/60 Hz
Power Consumption (W)	4.6 (max.)
Dimensions (H × W × D) (mm)	59.6 × 270.4 × 176
Weight (g)	1,200

# Network Convertor for LONWORKS®

UTY-VLGX

VRF



- For connection between VRF network system and a LONWORKS® open network for management of small to medium-sized BMS and VRF network system.
- The UTY-VLGX permits central monitoring and control of a VRF network system from a BMS through a LONWORKS® interface.
- Up to 128 Indoor units can be connected to one Network Convertor for LONWORKS®

Max. Controllable  
**4** units to BMS

Max. Controllable  
**100** outdoor units

Max. Controllable  
**128** indoor units

## Installation example

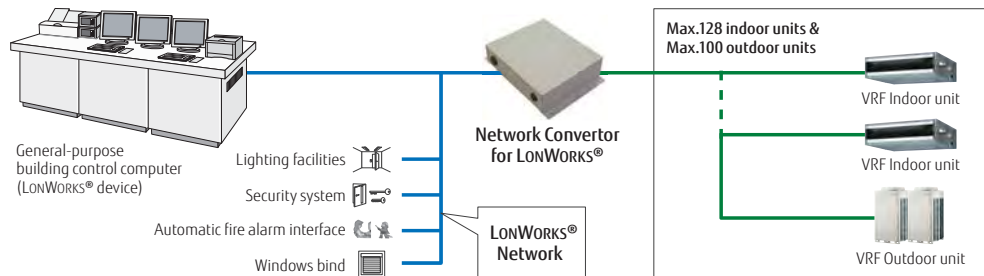

### Specifications

Model name	UTY-VLGX
Power Supply	208-240 V 50/60 Hz, Single phase
Power Consumption (W)	4.5
Dimensions (H × W × D) (mm)	67 × 288 × 211
Weight (g)	1,500

### Transmission specifications (BMS side)

Transmission speed	78 kbps
Transceiver	FT-X1 (Echelon® Corporation)
Transmission way form	Free topology
Terminal resistor	None (It attaches at the terminal of a network.)

# MODBUS<sup>®</sup> Convertor for VRF

UTY-VMGX

VRF

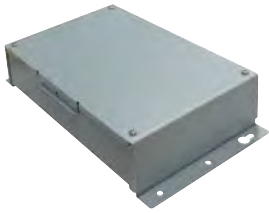

The MODBUS Convertor allows a complete integration of air conditioners into MODBUS Networks.

- Compact and lightweight design
- Direct connection to MODBUS Network
- Up to 128 indoor units can be controlled in one MODBUS Convertor
- The MODBUS Convertor permits central monitoring and control of air conditioners from BMS or Central Controller.
- Up to 9 converters can be connected to a VRF network. The simultaneous controls such as ON/OFF or temperature settings can be done for each zone.
- It is easy to locate the source of error if any connection errors should occur after completion of installation works.

Max. Controllable  
**9** units to one VRF

Max. Controllable  
**100** outdoor units

Selectable  
**128** indoor units

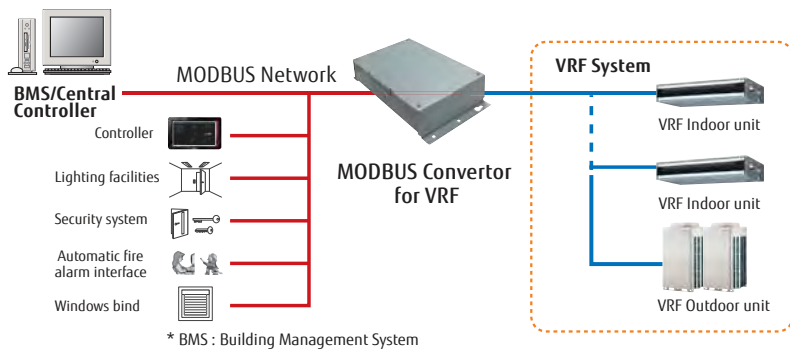

# KNX<sup>®</sup> Convertor for VRF

UTY-VKGX

VRF

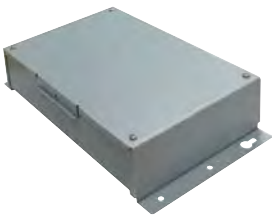

KNX Convertor is useful for centralised control in a system.

- New KNX Convertor enables to connect central/home controller and Fujitsu General VRF system.
- A maximum of 128 indoor units and 100 outdoor units can be connected to single KNX Convertor.

Max. Controllable  
**100** outdoor units

Selectable  
**128** indoor units

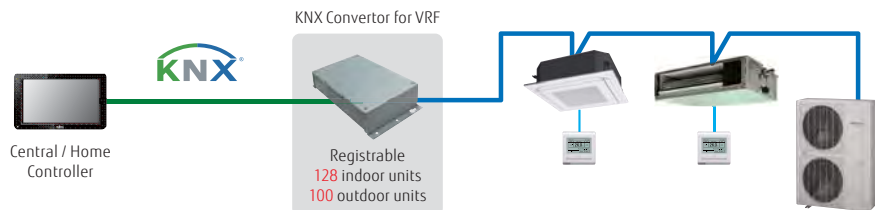

## Specifications

Model name	UTY-VMGX
Power Supply	220-240 V 50/60 Hz
Input power (W)	Max. 2
Dimensions (H × W × D) (mm)	54 × 260 × 150
Weight (g)	1,100

Model name	UTY-VKGX
Power supply	220-240 V 50/60 Hz
Power consumption (W)	1.5
Dimensions (H × W × D) (mm)	54 × 260 × 150
Weight (g)	1,200

# Signal Amplifier

UTY-VSGXZ1

VRF



- Transmission Line length can be extended up to 3,600 m with multiple Signal Amplifiers.
- Up to 8 signal amplifiers can be installed in a VRF network system.
- A signal amplifier is required,
  - (1) When the total wiring length of the transmission line exceeds 500 m.
  - (2) When the total number of units on the transmission line exceeds 64.

## Installation example

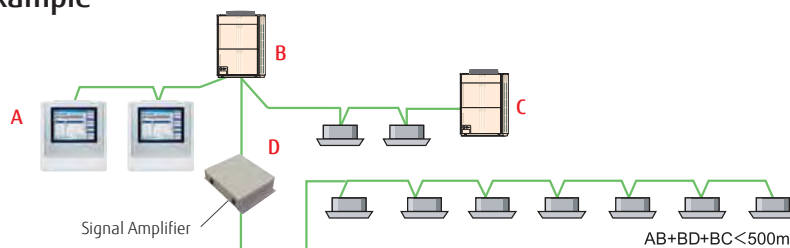

## Specifications

Model name	UTY-VSGXZ1
Power Supply	208-240 V 50/60 Hz, Single phase
Power Consumption (W)	4.5
Dimensions (H × W × D) (mm)	67 × 288 × 211
Weight (g)	1,500



# Optional Parts Overview

## VRF

Various optional parts are provided to install the selected indoor unit properly according to the environment.

### Optional Parts For Cassette



#### Human Sensor Kit

The room temperature can be controlled by detecting the temperature accurately from the built-in sensor



For Compact Cassette



For Cassette Circular Flow

#### Cassette Grille

Cassette grille lineup matching the various interior is available. In addition, grid ceiling type cassette grille is also added to the lineup.

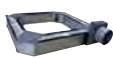

For Compact Cassette



For Cassette

#### Fresh Air Intake Kit

Fresh air can be taken in by a fan which can be connected using external control unit.

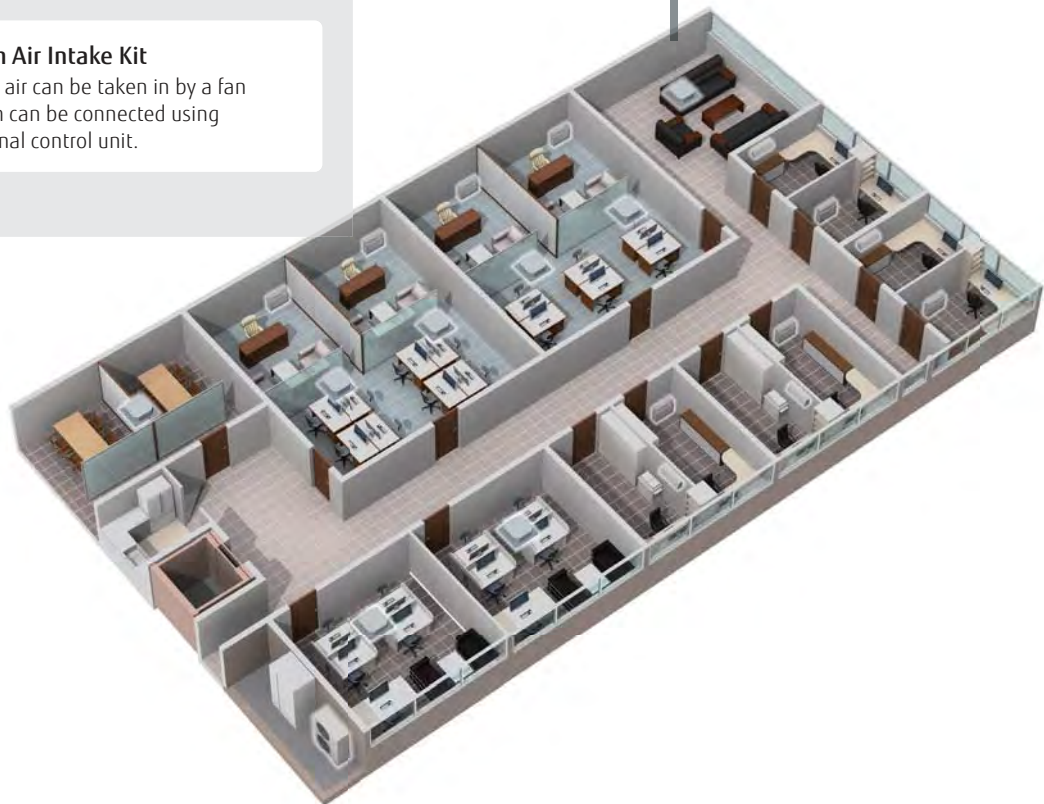



## Optional Parts For Duct & Ceiling



**Auto Louvre Grille Kit**  
Simple flat Auto louvre will provide comfort airflow and harmonise with luxury Interior



**Remote Sensor Unit**  
New amenity space can be offered by installing the Remote sensor.



**Long Life Filter**  
Grit and dust can be caught sufficiently. In consideration of running cost, long-life design is achieved.



**Flange**  
Flange is used for Medium Static Pressure Duct type and Ceiling type to connect between pipes.



**Drain Pump Unit**  
This device can drain the collected water during operation.

## Connection Parts

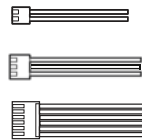

**External Connect Kit & Set**  
These wires can connect between the product PCB and external device.



**Connection Units**  
Connection units are provided to separate the pipes at the connection of multiple indoor units in multi-split type or VRF system.



**External Power Supply Unit**  
External Power Supply Unit can protect the units in the system even if some powers of indoor units are shut down in the system.

# Auto Louvre Grille Kit

UTD-GXSA-W / UTD-GXSB-W / UTD-GXSC-W

# SPLITS/MULTI/VRF



Simple flat Auto Louvre will provide comfort airflow and harmonise with luxury interior.



## Flexible Control

- Operation with indoor unit**  
 Auto Louvre can be operated by synchronising remote controller of indoor unit.
- UP and Down auto swing**
  - Auto airflow direction and auto swing
  - 4 steps selectable
- Auto-closing louvre**  
 When operation of indoor unit is stopped, the louvre will automatically close.

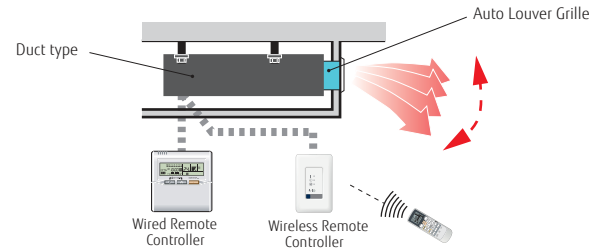

## Dimensions

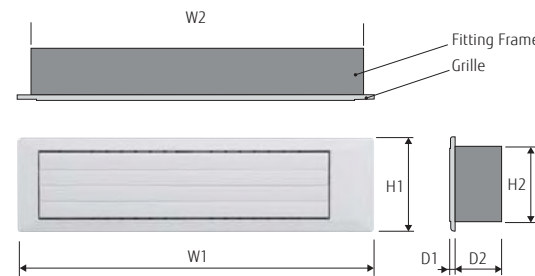

Unit:mm

Model Name	W1	W2	H1	H2	D1	D2
UTD-GXSA-W	683	645	180	148	9	84
UTD-GXSB-W	883	845				
UTD-GXSC-W	1,083	1,045				

## Specifications

Model name		UTD-GXSA-W		UTD-GXSB-W		UTD-GXSC-W	
Applicable Indoor Unit		ARYG07/09LLTA ARYG12/14LLTB ARXD007/009/012/014GLEH (For VRF) ARXK004/007/009/012/014GLEH (For VRF) ARXD04GALH (For VRF)		ARYG18LLTB ARXD018GLEH (For VRF) ARXK018GLEH (For VRF)		ARXD024GLEH (For VRF) ARXK024GLEH (For VRF)	
Power Supply		Connecting with Control box of indoor unit					
Fixing of Auto Louvre Grille		Screw fixing to Flange or Square Duct					
Extension Square Duct Limit		1.0m (Max. duct length between indoor unit and Grille)					
Net Dimension (H × W × D)		mm	180×683×(84+9)		180×883×(84+9)		180×1083×(84+9)
Weight	Net	kg (lbs)	2.0 (4.4)		2.5 (5.6)		3.0 (6.7)
	Gross		3.0 (6.7)		3.5 (7.8)		4.0 (8.9)
Color		White					
Louvre Motor		Stepping Motor					
Accessories		Fitting Frame, etc.					
Operation range	Cooling	°C	18 to 32				
		% RH	80% or less				
	Heating	°C	16 to 30				

# External Power Supply Unit

UTZ-GXXA

VRF



External Power Supply Unit can protect the units in the system even if some powers of indoor units are shut down in the system.

Power is supplied to the indoor unit from auxiliary power by connecting to External Power Supply Unit. This makes it possible to operate continuously without system error.

## High Reliability

- A: Main power shut down can be detected at power shut down detection part.
- B: The power for indoor unit expansion valve drive, etc. is supplied. (DC 12V, 5V)
- C: Power supply from External Power Supply Unit is notified.

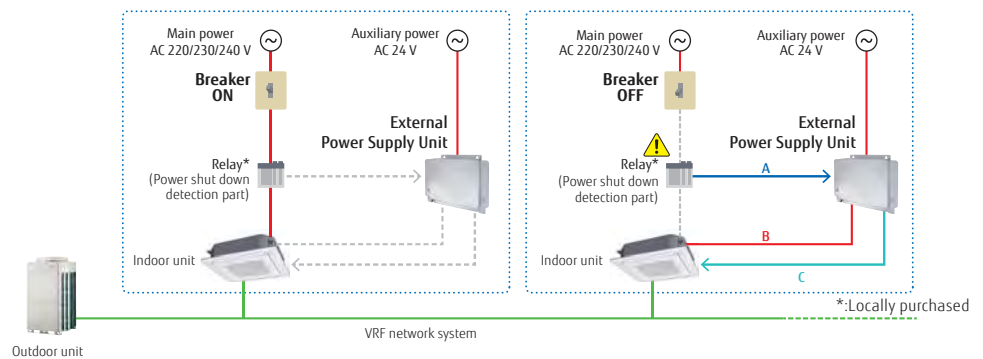

### Note

- When changing the power supply voltage to AC24V, use a power transformer with an insulation structure equivalent to CLASS 2.
- Indoor units that are powered off and driven by an External Power Supply Unit are handled in the same manner as operation off units in the electricity charge apportionment function. Since standby power may be charged to them, the electricity charge apportionment result for them may not be 0.

## Specifications

Model name	UTZ-GXXA
Power Supply	AC 24 V 50/60 Hz, single phase
Dimensions (H × W × D) (mm)	65 × 186 × 178
Weight (g)	500



# Optional Parts List For VRF

Type	Refrigerant	Indoor unit										
		3D Flow	Compact Grid type / Standard type	Cassette				Duct				
				Slim type	Large type	Slim type	Large type	Low Static Pressure Duct				
				4-way Flow		Circular Flow		Mini (With drain pump)	Slim (With drain pump)		Slim High Efficiency	
R410A	AUXS 018/024GLEH	AUXB 004/007/009/ 012/014/018/ 024GLEH	AUXD 18/24GALH	AUXA 18/24/30/ 36/45/54 GALH	AUXN 009/012/014 GLAH, AUXM 018/024/030 GLEH	AUXK 018/024/030/ 034/036/045/ 054GLEH	ARXK 004/007/009/ 012/014/018/ 024GLGH	ARXD 04GALH	ARXD 007/009/012/ 014/018/024 GLEH	ARXP 009/012/ 014/018 GLAH		
IR Receiver Unit		● UTY-TRHX			● UTY-LRHYB1		● UTY-LBHxD		● UTY-TRHX	● UTB-YWC	● UTY-TRHX	● UTB-YWC
Human Sensor Kit						● UTY-SHZXC						
Remote Sensor Unit	 New amenity space can be offered by installing the Remote sensor.									● UTY-XSZX		
Cassette Grille	 UTG-USYA-W UTG-UFYE-W UTG-UFYC-W UTG-UKYC-W UTG-UGYA-W	● UTG-USYA-W	● UTG-UFYE-W UTG-UFYC-W	● UTG-UGYA-W		● UTG-UKYC-W						
Auto Louver Grille Kit									● UTD-GXTA-W, UTD-GXTB-W (18), UTD-GXTC-W (24)		● UTD-GXTC-W (009/012/014)	
Long Life Filter												● UTD-LF25NA (018)
Flange												● UTD-SF045T (018) UTD-RF204 (018)
Drain Pump Unit												● UTZ-PXINBA (018)
Fresh Air Intake Kit*1	 For Compact Cassette For Cassette		● UTZ-VXAA	● UTZ-VXGA		● UTZ-VXRA						
External Power Supply Unit		● UTZ-GXXA				● UTZ-GXXA					● UTZ-GXXA	

















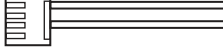

Indoor unit													
Duct						Floor		Floor / Ceiling	Ceiling	Wall Mounted			
Medium Static Pressure			High Static Pressure			-	EEV external			-	EEV external	-	-
Normal	High Efficiency		Normal	High Efficiency									
ARXA 024/030/ 036/045 GLEH	ARXQ 018/024GTAH	ARXP 024/030GTAH	ARXC 45/60GATH	ARXC 036/072/ 090/096 GTEH	ARXO 030GTAH	AGYA 004/007/ 009/012/014 GCGH	AGYE 004/007/ 009/012/014 GCEH	ABYA 012/014/ 018/024 GTEH	ABYA 030/036/ 045/054 GTEH	ASVA 004/007/009 GTEH, ASVA 012/014GCEH	ASVE 004/007/009 GTEH, ASVE 012/014GCEH	ASVA 18/24GBCH	ASVA 030/034GTEH
● UTY-TRHX	● UTB-YWC		● UTY-TRHX	● UTB-YWC									
● UTY-XSZX													
● UTD-LF25NA		● UTD-LFNA	● UTD-LF60KA (45/60/036)										
● UTD-SF045T UTD-RF204									● UTD-RF204				
● UTZ-PX1NBA									● UTR-DPB24T				
● UTZ-GXXA				● UTZ-GXXA		● UTZ-GXXA						● UTZ-GXXA	

# Function List For VRF

## External Inputs & Outputs

<p><b>For Indoor unit</b></p> <p>UTY-XWZXZ7 </p> <p>UTY-XWZXZB </p> <p>UTY-XWZXZC </p>	<p>UTY-XWZXZD </p> <p>UTY-XWZXZE </p>	<p><b>For Outdoor unit</b></p> <p>UTY-XWZXZ6 </p> <p>UTY-XWZXZ9 </p> <p>UTY-XWZXZF </p>
<p><b>For RB unit</b></p> <p>UTY-XWZXZ6 </p> <p>UTY-XWZXZB </p>	<p><b>For Central Remote Controller</b></p> <p>UTY-XWZXZ7 </p> <p>UTY-XWZXZ8 </p> <p>UTY-XWZXZA </p>	<p><b>For Touch Panel Controller</b></p> <p>UTY-XWZXZA </p>

## Function list

	Indoor unit	Outdoor unit	Controller		Other	
			Central Remote Controller	Touch Panel Controller	RB Unit	
Input	Operation / Stop	●UTY-XWZXZD ○UTY-XWZXZB	—	—	—	
	All On / All Off	—	—	●*3 ○*3	—	
	Batch Stop	—	●UTY-XWZXZ6	—	—	
	Forced Stop	●UTY-XWZXZD ○UTY-XWZXZB	—	—	—	
	Emergency Stop	●UTY-XWZXZD ○UTY-XWZXZB	●UTY-XWZXZ6	●UTY-XWZXZ7 ○UTY-XWZXZ8	●*3 ○*3	—
	Forced Thermostat off	●UTY-XWZXZE ○UTY-XWZXZ7	—	—	—	—
	Low Noise Mode Operation	—	●UTY-XWZXZ6	—	—	—
	Cooling / Heating Priority	—	●UTY-XWZXZ6*1	—	—	●UTY-XWZXZ6 ○UTY-XWZXZB
	"Outdoor Unit Operation Peak Control"	—	●UTY-XWZXZ6	—	—	—
	"Power Usage Information from Electricity Meter"	—	●UTY-XWZXZF	—	●*3 ○*3	—
Output	Operation Status	●UTY-XWZXZC	○UTY-XWZXZ6	○UTY-XWZXZA	○UTY-XWZXZA	—
	Error Status	●UTY-XWZXZC	○UTY-XWZXZ6	○UTY-XWZXZA	○UTY-XWZXZA	—
	Indoor Unit Fan Operation Status	●UTY-XWZXZC	—	—	—	—
	Auxiliary Heater Output	●UTY-XWZXZC*2	—	—	—	—
	Base Heater	—	●UTY-XWZXZ9	—	—	—

\*1. Heat Pump type only

\*2. Duct type only

\*3. Touch Panel Controller has these functions for Dry contact and Apply voltage, however, above External Connect Kit is not necessary because Touch Panel Controller has an external input terminal block.

●: Dry Contact ○: Apply Voltage

For Duct type

**Flange (Round)**

UTD-RF204

For Medium Static Pressure Duct type /  
Ceiling type - pack of 4



**Flange (Square)**

UTD-SF045T

For Medium Static Pressure Duct type



**Remote Sensor Unit**

UTY-XSZX

For All Duct type

New amenity space can be offered by installing the Remote sensor.



**Long-Life Filter**

UTD-LF25NA

For Medium Static Pressure Duct type



UTD-LF60KA

For High Static Pressure Duct type



**Auto Louvre Grille Kit**

UTD-GXSA-W

(for ARXD04-14GALH, ARXK07-12GCLH)

UTD-GXSB-W

(for ARXD18GALH)

UTD-GXSC-W

(for ARXD24GALH)



**Drain Pump Unit**

UTZ-PX1NBA

For Medium Static Pressure Duct type



For Cassette type

**Fresh Air Intake Kit**

UTZ-VXAA

For Compact Cassette type

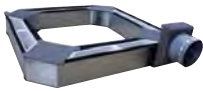

**Fresh Air Intake Kit**

UTZ-VXGA

For Cassette type



**Fresh Air Intake Kit**

UTZ-VXRA

For Circular Flow Cassette type



**Human Sensor Kit**

UTY-SHZXC

For Circular Flow Cassette



**Cassette Grille**

UTG-UFYD-W

For Compact Cassette type



**Cassette Grille**

UTG-UKYC-W

For Circular flow Cassette type



**Cassette Grille**

UTG-UFYE-W

For Compact Cassette type VRF



For Ceiling type

**Drain Pump Unit**

UTR-DPB24T

For Ceiling type



**Flange (Round)**





UTD-RF204

For Ceiling type  
pack of 4





















# Separation Tube etc.











## For SPLIT/MULTI SPLIT/SIMULTANEOUS MULTI

Separation Tube		Comtest	Service Monitoring Tool	Heat Sink Pack
UTPSX236A / UTPSX254A For 3-phase Simultaneous Multi  UTPSX272A For Simultaneous Multi Twin / Triple / Quad  	UTPSX354A For 3-phase Simultaneous Multi  UTPSX372A For Simultaneous Multi Twin / Triple / Quad  	Comtest COMTEST  	Service Monitoring Tool UTYASSX  	Heat Sink Pack HSPACK01  

## For VRF

Separation Tube			
UTPAX054A  Gas Pipe    Liquid Pipe  	UTPAX090A  Gas Pipe    Liquid Pipe  	UTPAX180A  Gas Pipe    Liquid Pipe  	UTPAX567A  Gas Pipe    Liquid Pipe  
UTPBX090A  Suction Gas Pipe    Discharge Gas Pipe    Liquid Pipe  	UTPBX180A  Suction Gas Pipe    Discharge Gas Pipe    Liquid Pipe  	UTPBX567A  Suction Gas Pipe    Discharge Gas Pipe    Liquid Pipe  	UTPLX180A For DX-Kit  

## Header

UTRH0906L UTRH1806L  Gas Pipe    Liquid Pipe  	UTRH0908L UTRH1808L  Gas Pipe    Liquid Pipe  	UTRJ0906A UTRJ1806A Suction Gas Pipe    Discharge Gas Pipe    Liquid Pipe  	UTPJ0908A UTPJ1808A Suction Gas Pipe    Discharge Gas Pipe    Liquid Pipe  
---	---	---	--

## Outdoor Unit Branch Kit

UTPCX567A  Gas Pipe    Liquid Pipe  	UTPDX567A  Suction Gas Pipe    Discharge Gas Pipe    Liquid Pipe  	USB Adaptor USB75010R Needed for UTYASGXZ1 UTYAMGXZ1 UTYALGXZ1 UTYAPGXZ1 UTYABGXZ1  	Outdoor Unit Strip & Rebuild (Terms & Conditions Apply)  
--	---	---	---

## For VRF

### EV Kit

Model code ≧ 09 : UTR-EV09XB  
 Model code ≧ 12 : UTR-EV14XB For  
**Compact Wall Mounted type**



### RB Unit

UTP-RX01AH  
 UTP-RX01BH  
 UTP-RX01CH  
**Single type**



UTP-RX04BH  
**Multi-split type**



UTP-RX08AH  
**Multi-split type**

NEW



UTP-RX12AH  
**Multi-split type**

NEW



## Specifications

### Separation Tube

Model name	UTP-AX054A	UTP-AX090A	UTP-AX180A	UTP-AX567A
Total cooling capacity of indoor unit (kW)	19.6 or less	28.0 or less	28.1 to 56.0	56.1 or more

Model name	UTP-BX090A	UTP-BX180A	UTP-BX567A
Total cooling capacity of indoor unit (kW)	28.0 or less	28.1 to 56.0	56.1 or more

### Header

Model name	3-6 Branches	UTR-H0906L	UTR-H1806L
	3-8 Branches	UTR-H0908L	UTR-H1808L
Total cooling capacity of indoor unit (kW)	28.0 or less		28.1 to 56.0

Model name	3-6 Branches	UTP-J0906A	UTP-J1806A
	3-8 Branches	UTP-J0908A	UTP-J1808A
Total cooling capacity of indoor unit (kW)	28.0 or less		28.1 to 56.0

### Outdoor unit Branch kit

Model name	UTP-CX567A (for V-III/V-III Tropical)	UTP-DX567A (for VR-II)
Number of outdoor unit	2 outdoor units	1
	3 outdoor units	2

### EV Kit

Model name	UTR-EV09XB		UTR-EV14XB	
Application model	ASYE004GTEH ASYE007GTEH ASYE009GTEH	AGYE004GTEH AGYE007GTEH AGYE009GTEH	ASYE012GCEH ASYE014GCEH	AGYE012GCEH AGYE014GCEH

### RB Unit

Type	Single type			Multi-split type		
Model name	UTP-RX01AH	UTP-RX01BH	UTP-RX01CH	UTP-RX04BH	UTP-RX08AH	UTP-RX12AH
Power source	V/∅/Hz					
	230/ 1 / 50					
Input power	17	24	31	96	136	204
Number of branches	1	1	1	4	8	12
Maximum capacity of connectable indoor units (Q)	Q ≤ 8.0	Q ≤ 18.0	Q ≤ 28.0	Q ≤ 56.1*1	Q ≤ 72.0	Q ≤ 95.0
Maximum capacity of connectable indoor units per branch (Q)	Q ≤ 8.0	Q ≤ 18.0	Q ≤ 28.0	Q ≤ 18.0	Q ≤ 8.0	Q ≤ 8.0
Maximum number of connectable indoor units per branch	3	8	8	8	7	7
Dimensions (H×W×D)	198×298×268			260×658×428	298×660×618	298×990×618

\*1: In case of two RB units connected in series ( total 8-branches ), maximum capacity of connectable indoor units is up to 56.0 kW.

# Service Tool

## Extensive monitoring and analysis functions for installation and maintenance

- Operation status can be checked and analysed to detect even the smallest abnormalities
- Storage of data on system operation status on a PC allows access even from off site.
- Up to 400 indoor units (a single VRF network system) can be controlled and monitored for large scale buildings or hotels
- This software can be connected to any point of transmission line with USB adaptor (locally purchased)

\* The saved data can be displayed offline. However, the data saved by the following model cannot be displayed.

- UTR-YSTB/UTR-YSTC (Service Tool)
- UTR-YMSA (Web Monitoring Tool)

## Automatic operation check for refrigeration cycle

After product installation, operation check can be performed automatically. Self-diagnosis function automatically judges whether each sensor value is normal, so the operation check work can be reduced. The diagnosis can also be output as a report.



[Note] Use only as a guide and judge for yourself finally.

Whether each sensor value is normal is judged automatically.

- ✓ Discharge temperature normal value OK
- ✓ Super heat volume normal value OK
- ✓ High pressure pipe normal value OK
- ✓ Low pressure pipe normal value OK
- ...etc.



## Remote technical support & maintenance

On-site check screen can be shared with the skilled person in a distant place. When visiting for troubleshooting on site, operation status can be shared in real time and get assistance easily. Online chat function helps to support on site staff.

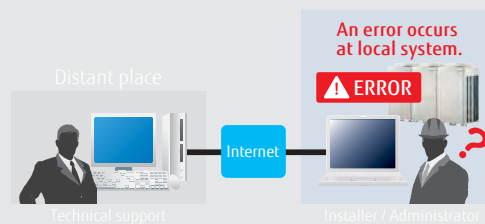

## Various trend graph display

Previously, only 3 kinds of each sensor value can be displayed. However, multiple graphs can be displayed in new Service Tool depending on the situation. The refrigeration cycle can be checked in detail.

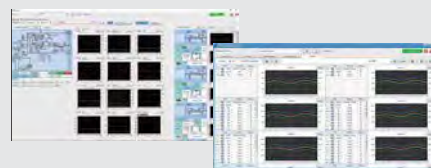

## Personal computer system requirements

UTY-ASGXZ1	
Operating system	<ul style="list-style-type: none"> <li>• Microsoft® Windows® 7 Professional (32-bit or 64-bit) SP1</li> <li>• Microsoft® Windows® 8.1 Pro (32-bit or 64-bit)</li> <li>• Microsoft® Windows® 10 Pro (32-bit or 64-bit)</li> </ul>
CPU	1 GHz or higher
Memory	<ul style="list-style-type: none"> <li>• 1 GB or more (for Windows® 7 [32-bit], Windows® 8.1 [32-bit], and Windows® 10 [32-bit])</li> <li>• 2 GB or more (for Windows® 7 [64-bit], Windows® 8.1 [64-bit], and Windows® 10 [64-bit])</li> </ul>
HDD	40 GB or more of free space
Display	1366 x 768 or higher resolution
Interface	• USB port for U10 USB Network Interface and Software protection key
Software	Internet Explorer® 11 or Microsoft Edge

### <Packing list>

Name and shape	Quantity	Application
WHITE-USB-KEY (Software protection key)	1	Software protection key to be connected to USB port on the Service Tool-installed PC. These products run only on a PC with WibuKey.

- Personal computer that satisfies the following system requirements
- Echelon® U10 USB Network Interface – TP/FT-10 Channel (Model number: 75010R) (Required for each VRF Network.)

# Web Monitoring Tool

## Product features

- Troubleshooting is performed by monitoring each air conditioning unit remotely during periodical system checks.
- Error notification can be automatically transmitted to several locations using the internet\*1.
- Requires either a dedicated internet connection or public telephone line.
- Determination of an error occurrence can be made through error warnings and equipment status information obtained from a remote location.
- The monitoring data in a remote side can be optionally downloaded. And, this data can be displayed in offline mode of the service tool.
- Monitoring side computer is not required to install special software, requires only general web browser.

\*1: Use of internet mail system required.

## Web Monitoring System

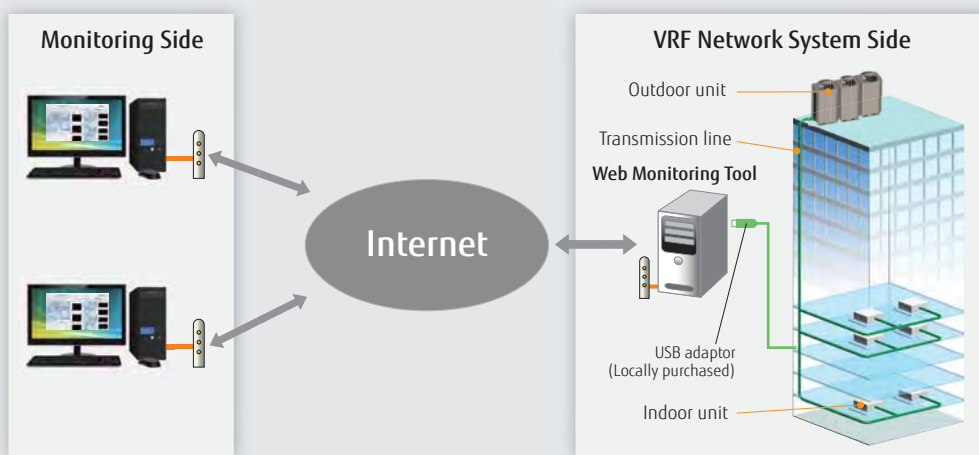

## Support 4 VRF network systems

USB adaptor (max. 4 adaptors per PC) permit, monitoring of up to 1,600 indoor units.

Suitable for large-scale buildings or hotels.

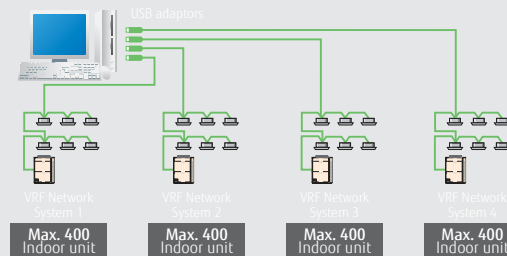

## Personal computer system requirements

	UTY-AMGXZ1
Operating system	<ul style="list-style-type: none"> <li>• Microsoft® Windows® 7 Professional (32-bit or 64-bit) SP1</li> <li>• Microsoft® Windows® 8.1 Pro (32-bit or 64-bit)</li> <li>• Microsoft® Windows® 10 Pro (32-bit or 64-bit)</li> </ul>
CPU	1 GHz or higher
Memory	<ul style="list-style-type: none"> <li>• 1 GB or more (for Windows® 7 [32-bit], Windows® 8.1 [32-bit], and Windows® 10 [32-bit])</li> <li>• 2 GB or more (for Windows® 7 [64-bit], Windows® 8.1 [64-bit], and Windows® 10 [64-bit])</li> </ul>
HDD	40 GB or more of free space
Display	1366 x 768 or higher resolution
Interface	<ul style="list-style-type: none"> <li>• USB port (for 10 USB Network Interface Max.4, Software protection key)</li> <li>• Either of the following interface is required for remote connection:                             <ul style="list-style-type: none"> <li>- Public Telephone Line: Modem is required</li> <li>- Internet using LAN: Ethernet port is required</li> </ul> </li> </ul>
Software	Internet Explorer® 11 or Microsoft Edge

## <Packing list>

Name and shape	Quantity	Application
WHITE-USB-KEY (Software protection key)	1	Software protection key to be connected to USB port on the Service Tool-installed PC. These products run only on a PC with WibuKey.

- Personal computer that satisfies the following system requirements
- Echelon® U10 USB Network Interface - TP/FT-10 Channel (Model number: 75010R) (Required for each VRF Network.)

# Refrigerant Leak Detection

The F-Gas regulations are an EU environmental regulation brought into effect on the 4th July 2007, as part of the European Union's obligations under the Kyoto protocol. F-gasses or HFC's (hydrofluorocarbons) can cause harm to our environment and cause climate change. These regulations are directed at reducing cover both pure HFC's such as R134a and blends like R404a.

## Refrigerant Leak Detection

To Meet the requirements of BS-EN378 all split / VRF systems containing refrigerant gasses installed in a Category Class A space (Hotel Bedroom or similar) must meet the limitations regarding maximum system refrigerant volumes that could leak within the space

Fujitsu's Design Simulator program can be used to accurately calculate the actual refrigerant volumes based on the system size and the proposed pipe-work lengths and configuration

If these aforementioned limitations are exceeded there must be an alarm system to alert the occupier through both audible and visual indication, this alarm must also alert the staff such as supervisors, night porters etc.

There is no specific requirement for the alarm system to be linked to the refrigerant system to pump down or stop the operation.

## Individual Sensors



### TQ31

Monitors all refrigerant gasses typically used in air conditioning systems

Stand alone, single point refrigerant detector and alarm unit ideal for room monitoring.

Resistant to cross sensitivity from hairspray and deodorants so are ideally suited in a hotel / Bedroom environment.

Designed as a single point, self contained unit but can be connected to a TQ32 Area Alarm panel for remote monitoring and group alarms.



# Area Alarm Panels & Indicator Panel



## TQ32 (32 Channel & 64 Channel)

Upto 64 individual sensor inputs gives wide area coverage

The TQ32 Area Alarm Panel combined with the TQ31 sensors enables the group monitoring of individual rooms for common refrigerants used in air conditioning systems

Designed for hotel or office use, a single alarm panel will typically monitor 1 or 2 floors depending on the number of sensors needed.

The 3 digit LED display shows individual room numbers.

Configurable alarm outputs can provide plant trip signals and alert the reception desk, via the optional TQ34 indicator panel or a 3rd party alarm.

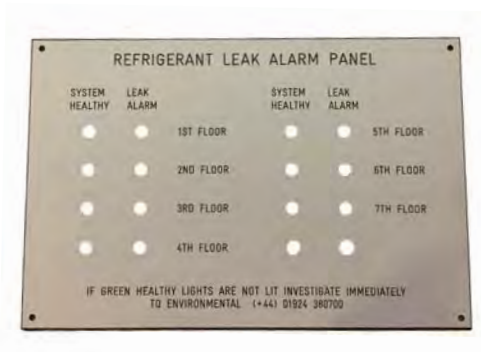

## TQ34

Upto 8(max) Area Alarm Panel inputs for whole building coverage

The TQ34 Floor Indicator Panel combined with the TQ32 Area Alarm Panels and the TQ31 Individual Sensors enables the monitoring of the entire building

Designed for hotel or office use, a Indicator panel will typically monitor 1-8 floors depending on the number of Area Alarm panels used



### Specifications

Model name	TQ31	TQ32 (32 Channel)	TQ32 (64 Channel)	TQ34
Power Source	220/240v 50Hz	220/240v 50Hz	220/240v 50Hz	220/240v 50Hz
Power Consumption	<1.5w	<1.5w	<1.5w	<1.5W
Max switching current (Amp)	2	2	2	2
Indicator LED's	Power, Alarm	Power, Alarm, Room Number	Power, Alarm, Room Number	Power, Alarm, Floor Number
Audible Alarm (minimum dB)	75	85	85	85
Gases Detected	Halocarbon Refrigerants	-	-	-
Detection Range	10000 PPM (factory set 1000-5000)	-	-	-
Dimensions (H x W x D) (mm)	85 x 146 x 50	364 x 284 x 120	364 x 284 x 120	364 x 284 x 120
Weight (Kg)	0.3	1 approx.	1 approx.	1 approx.

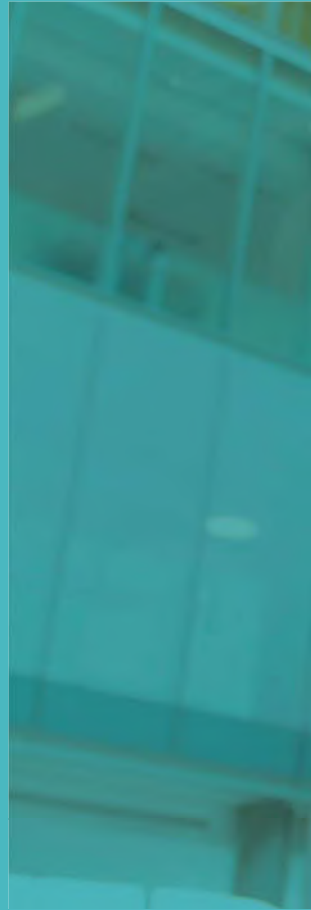

## Residential, Commercial & Light Commercial

# VENTILATION

### VENTILATION Lineup

- 228 Energy Recovery Ventilator
- 232 DX-Kit for Air Handling Application
  - for VRF Outdoor Unit
- 234 DX-Kit for Air Handling Application
  - for Single Split Outdoor Unit
- 236 AIR HANDLING UNIT

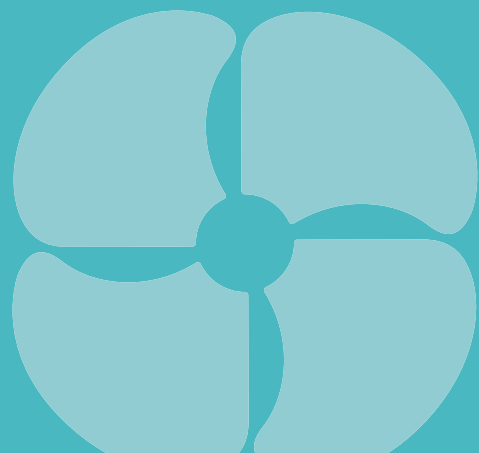

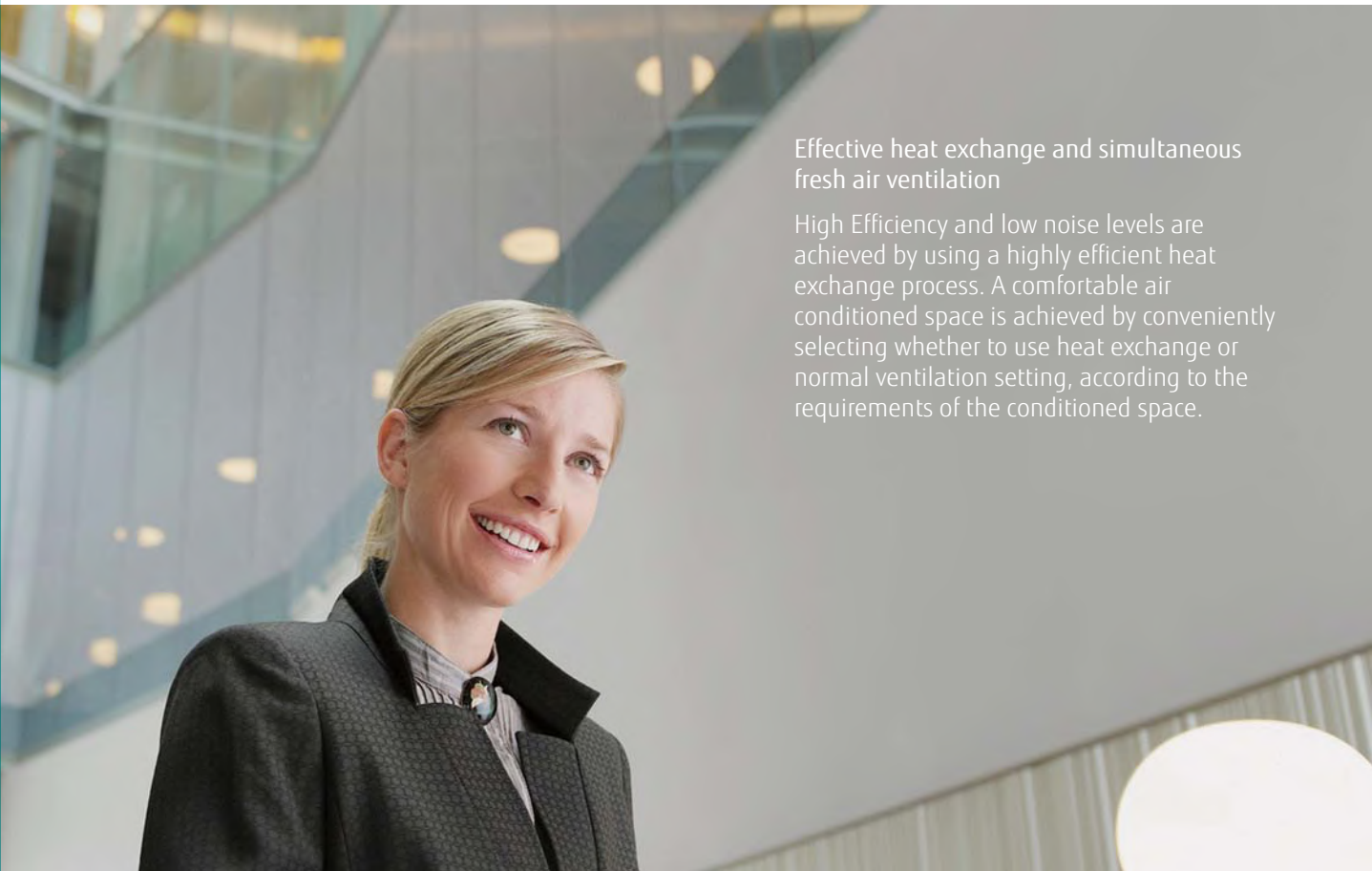











Effective heat exchange and simultaneous fresh air ventilation

High Efficiency and low noise levels are achieved by using a highly efficient heat exchange process. A comfortable air conditioned space is achieved by conveniently selecting whether to use heat exchange or normal ventilation setting, according to the requirements of the conditioned space.

## Lineup

Airflow rate (m <sup>3</sup> /h)	250		350		500		800		1000	
<b>Energy Recovery Ventilator</b>										
	UTZ-BD025C		UTZ-BD035C		UTZ-BD050C		UTZ-BD080C		UTZ-BD100C	
Connectable capacity class (kW)	5.0	6.3	8.0	10.0	12.5	14.0	20.0	25.0	40.0	50.0
<b>DX-Kit for Air Handling Applications for VRF Outdoor Unit</b>										
	EEV unit UTP-VX30A Control unit UTY-VDGX		EEV unit UTP-VX60A Control unit UTY-VDGX		EEV unit UTP-VX90A Control unit UTY-VDGX		EEV unit UTP-VX90A×2 Control unit UTY-VDGX			
Connectable capacity class (kW)	3.5 - 22.0									
<b>DX-Kit for Air Handling Applications for Single Split Outdoor Unit</b>										
	UTY-XDZXUK									
Connectable capacity class (kW)	25 - 96									
<b>Air Handling Unit</b>										
	AHYA / AHYB / AHYC / AHYD / AHYE									

# Energy Recovery Ventilator



Energy recovery ventilator unit offers maximum comfort and greater energy savings.

## Heat exchange ventilation and normal ventilation

### Heat exchange ventilation

When a room is cooled or heated, the exhausted cooling / heating energy is recovered by heat-exchange ventilation.

### Normal ventilation

The operation is used during periods when the room space requires no cooling or heating effect, i.e. when there is minimal temperature difference between the indoor and outdoor environments.

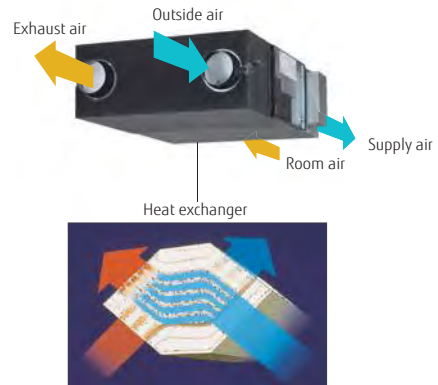

Adopts a highly efficient counter-flow heat exchange element

## Energy efficiency and ecology

Energy consumption is dramatically reduced by using a counter-flow heat-exchange element. Air conditioning load is reduced by approximately 20%, resulting in significant energy savings. Recovers up to 77% of the heat in the outgoing air.

## Features of heat exchange element

With the cross-flow element, air moves in a straight line across the element. With the counter-flow element, air flows through the element for a longer time (longer distance), so the heat-exchange effect improved.

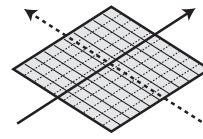

Other element (Cross-flow element)

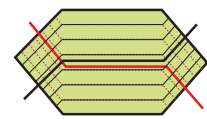

Fujitsu element (Counter-flow element)

## Quiet operation

Significantly reducing low pressure loss and noise allows low-noise operation.

**25.5dB**  
(UTZ-BD035C)

## Extended range of an external static pressure

An external static pressure is improved by adopting a powerful fan motor. This allows for application in a wide variety building.

## Slim shape and easier installation

Counter-flow heat exchange element used for reduced noise and slimmer, more compact body shape.

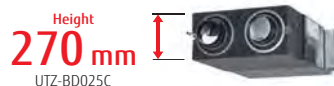

## Reverse mountable direct air supply / exhaust system

Adoption of straight air supply / exhaust system: Duct design is simplified because the air supply / exhaust ducts are straight.

Since each unit can be mounted in reverse position, only one inspection hole is needed for two units: Two units can share one inspection hole so duct work is easier and more flexible.

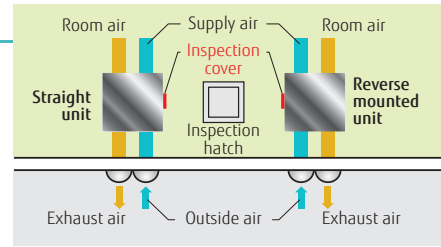

## Simple remote operation

Easy operation by connecting a liquid crystal switch

- POWER ON/OFF
- Air volume High/Low
- Heat exchange/Normal Ventilation
- ON/OFF Timer
- Clean filter display



Model : UTZ-BD025C / UTZ-BD035C / UTZ-BD050C / UTZ-BD080C / UTZ-BD100C



UTZ-BD025C



UTZ-BD035C



UTZ-BD050C



UTZ-BD080C



UTZ-BD100C

## Specifications

Rated flow rate			250 m <sup>3</sup> /h	350 m <sup>3</sup> /h	500 m <sup>3</sup> /h	800 m <sup>3</sup> /h	1000 m <sup>3</sup> /h	
Model No.			UTZBD025C	UTZBD035C	UTZBD050C	UTZBD080C	UTZBD100C	
Power source			220 - 240V, 50Hz					
Heat Exchange Ventilation	Input power	(Extra high)/High/Low	W	128 / 123 / 96	190 / 185 / 168	289 / 225 / 185	418 / 378 / 295	464 / 432 / 311
	Air flow rate	(Extra high)/High/Low	m <sup>3</sup> /h	250 / 250 / 190	350 / 350 / 240	500 / 500 / 440	800 / 800 / 630	1000 / 1000 / 700
	External static pressure	(Extra high)/High/Low	Pa	105 / 95 / 45	140 / 60 / 45	120 / 60 / 35	140 / 110 / 55	105 / 80 / 75
	Temperature Exchange Efficiency	(Extra high)/High/Low	%	75 / 75 / 77	75 / 75 / 78	75 / 75 / 76	75 / 75 / 76	75 / 75 / 79
	Energy Exchange Efficiency Cooling	(Extra high)/High/Low	%	63 / 63 / 65	66 / 66 / 71	62 / 62 / 64	65 / 65 / 68	65 / 65 / 70
	Energy Exchange Efficiency Heat pump	(Extra high)/High/Low	%	70 / 70 / 72	69 / 69 / 73	67 / 67 / 69	71 / 71 / 74	71 / 71 / 76
	Sound pressure level	(Extra high)/High/Low	dB*	31.5 / 30.5 / 26.5	33 / 31 / 25.5	37.5 / 35.5 / 32.5	37.5 / 37 / 34.5	38.5 / 37.5 / 34.5
Normal Ventilation	Input power	(Extra high)/High/Low	W	128 / 123 / 96	190 / 185 / 168	289 / 225 / 185	418 / 378 / 295	464 / 432 / 311
	Air flow rate	(Extra high)/High/Low	m <sup>3</sup> /h	250 / 250 / 190	350 / 350 / 240	500 / 500 / 440	800 / 800 / 630	1000 / 1000 / 700
	External static pressure	(Extra high)/High/Low	Pa	105 / 95 / 45	140 / 60 / 45	120 / 60 / 35	140 / 110 / 55	105 / 80 / 75
	Sound pressure level	(Extra high)/High/Low	dB*	31.5 / 30.5 / 26.5	33 / 31 / 25.5	38.5 / 38 / 32.5	37.5 / 37 / 34.5	40.5 / 39.5 / 36.5
Dimensions	W×D×H	mm	882 x 599 x 270	1050 x 804 x 317	1090 x 904 x 317	1322 x 884 x 388	1322 x 1134 x 388	
Weight		kg	29	49	57	71	83	
Outlet duct diameter		mm	150	150	200	250	250	
Operation range		°C	-10 to 40	-10 to 40	-10 to 40	-10 to 40	-10 to 40	
Maximum humidity		%	85	85	85	85	85	

\* The noise level must be measured 1.5 m below the centre of the unit.

## Dimensions

(Unit : mm)

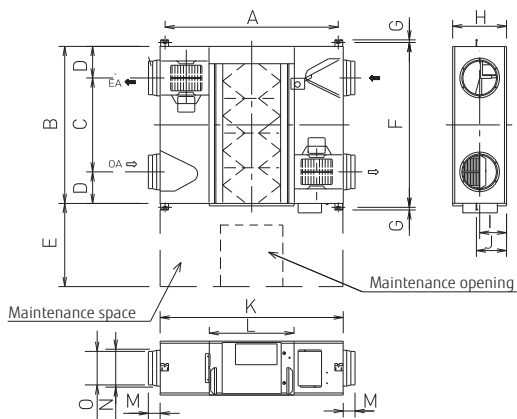

	UTZ-BD025C	UTZ-BD035C	UTZ-BD050C	UTZ-BD080C	UTZ-BD100B
A	810	978	1,018	1,250	1,250
B	599	804	904	884	1,134
C	315	580	640	428	678
D	142	112	132	228	228
E	600	600	600	600	600
F	655	860	960	940	1,190
G	19	19	19	19	19
H	270	317	317	388	388
I	135	159	159	194	194
J	159	182	182	218	218
K	882	1,050	1,090	1,322	1,322
L	414	470	470	612	612
M	95	70	70	85	85
N	Ø164	Ø164	Ø210	Ø258	Ø258
O	Ø144	Ø144	Ø194	Ø242	Ø242

# Energy Recovery Ventilator Options

Energy recovery ventilator unit offers maximum comfort and greater energy savings.



## ERV RELAY

This accessory will allow an Energy Recovery Ventilator unit to start & stop in unison with the connected indoor unit  
(There will be no control over on / off, fan speed or damper bypass)

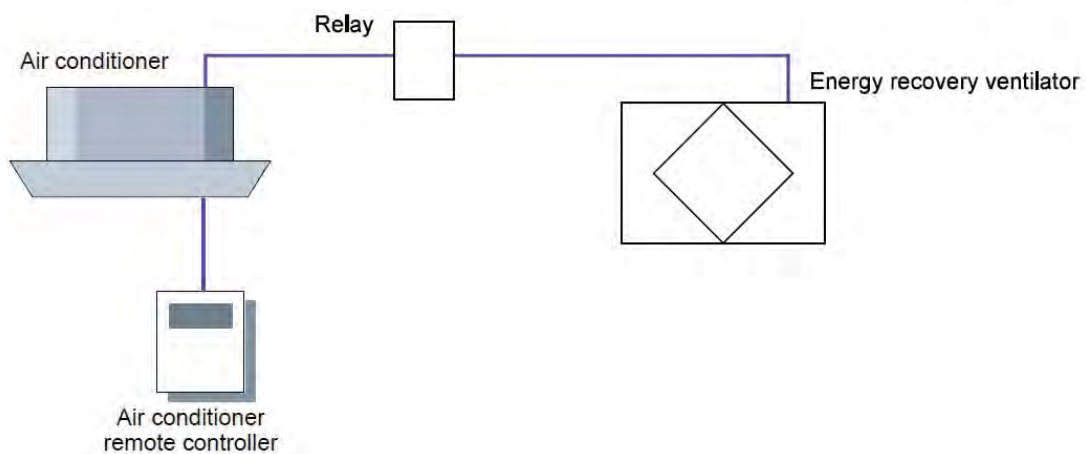

Model Name		UTY-ERVRELAY1	
Power source		208 - 240V, 50Hz, Single Phase	
Dimensions (H x W x D)	mm	TBC	
Weight	g	TBC	

# Hard wired Control Interface

In order to use a Fujitsu hard-wired controller with the ERV units an interface is required

The UTIERV2 interface provides the following features:-

- UTI-ERV2 interface is supplied with an outside air intake duct sensor for control of the ERV bypass damper e.g. heat recovery or "free cooling" bypass mode
- Dry contact terminals for remote on/off e.g. from BMS
- Allows the use of a Fujitsu UTY-RNNYM\* hard wired controller which has the following features:
- Allows ERV fan speed selection from the remote controller
- Controller has an integral 7 day programmable time clock
- Controller has temperature selection for auto control of the damper
- Filter clean indicator facility
- Manual or Auto control of the bypass damper

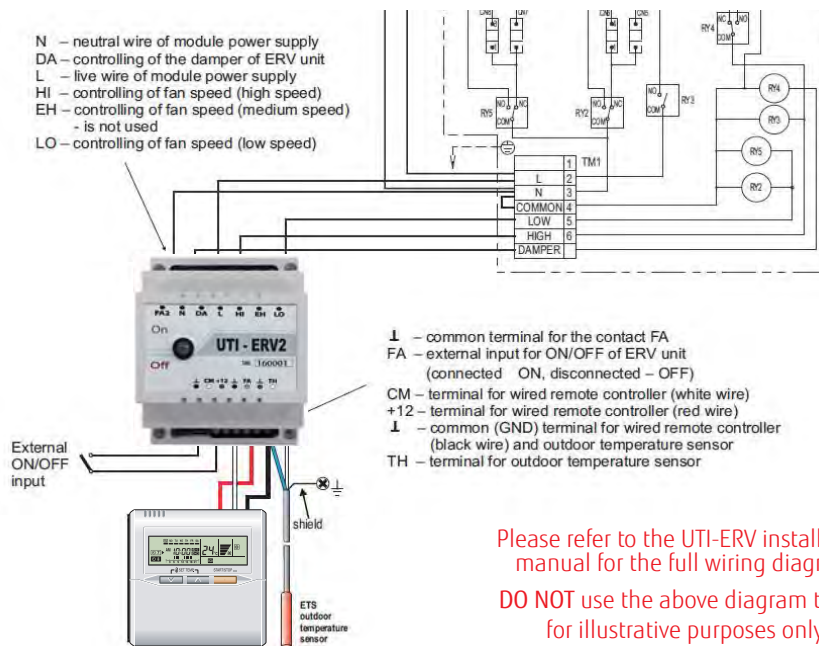

Please refer to the UTI-ERV installation manual for the full wiring diagram  
DO NOT use the above diagram this is for illustrative purposes only

## Description of the buttons on UTY-RNNYM remote

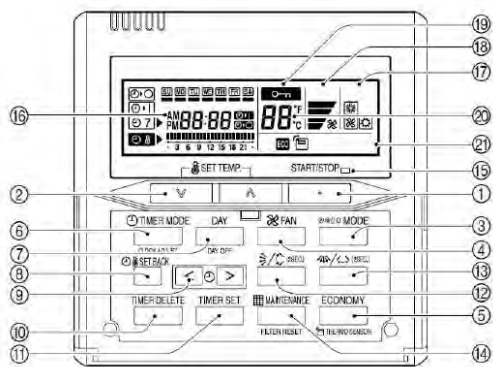

1. Start / Stop
  2. Set Temperature
  3. Master Control
  4. Fan Control
  5. ERV on/off
  6. Timer mode (clock adjust)
  7. Day (day off)
  8. Set Back
  9. Set Time
  10. Delete
  11. Set
  12. N/A
  13. N/A
  14. Filter Button
  15. Operation Lamp
  16. Timer & Clock Display
  17. Operation Mode Display
  18. Fan Speed Display
  19. Operation Lock Display
  20. Temperature Display
  21. Function Display
- Delete  
 Set Button

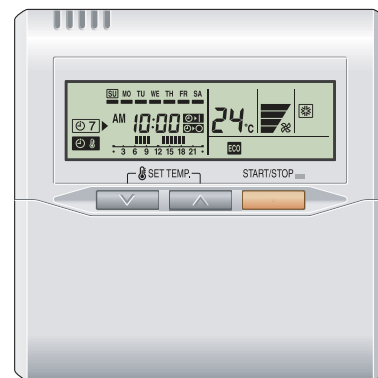

Model Name	UTIERV2		UTYRNNYM
Power source	208 - 240V, 50/60Hz, Single Phase		From UTIERV2
Power Consumption	W	6.5	-
Dimensions (H x W x D)	mm	67 x 288 x 211	120 x 120 x 18
Weight	g	1,500	160

\*UTYRNNYM to be ordered separately

# DX-Kit for Air Handling Application for VRF Outdoor Unit



These kits enable other manufacturers air handling units (AHU) and fan coil units (FCU) to be incorporated into a Fujitsu VRF system or, be connected to a dedicated Fujitsu VRF outdoor unit as a 1:1 system to control outside air ventilation (AHU) or room temperature (FCU).

## Multiple temperature sensors optimally control the air handling unit and fan coil unit.

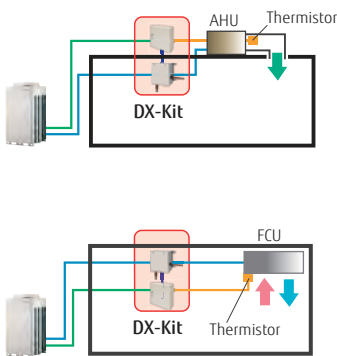

When connecting to an air handling unit, the supply air temperature is controlled by the discharge sensor.

When connecting to a fan coil unit, the room temperature is controlled by the return air temperature sensor.

### Arrangement as part of a VRF system

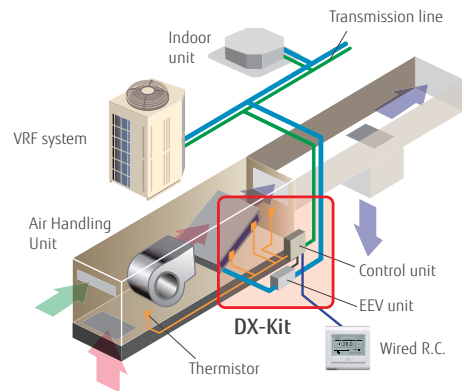

## Supports a wide range of capacity classes

- 2 EEV units can be connected in parallel and up to 20 HP (50 kW) large capacity units. (Separation Tube of UTP-LX180A is required.)
- Connectable capacity range: 5 kW to 50 kW

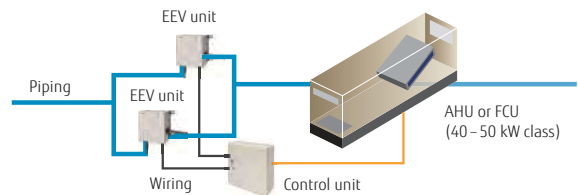

## A variety of controls to match the application

Central control using our VRF controllers or central management controllers

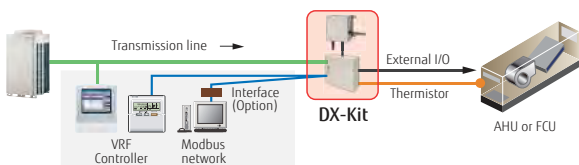

Central control from external controllers

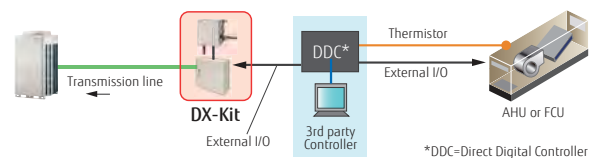

\*DDC=Direct Digital Controller



## Functions Summary

## Inputs

- ON/OFF
- Setting temperature
- Capacity demand
- Heating / Cooling operation mode
- Fault information

## Outputs

- ON/OFF indication
- Fan ON/OFF indication
- Thermo ON/OFF indication
- Defrost indication
- Fault indication

## MODBUS® Control

Possible to control via a MODBUS enabled BMS by using optional interface.

## Installation Limitation

- Connectable VRF Series: All VRF Series
- Connectable DX-Kit system capacity range: 50 to 100% of the outdoor unit capacity
- Connectable DX-Kit system capacity range with indoor units: 30% or less of the outdoor unit capacity
- Max. wiring length from control unit: 10 m
- Max. piping length between EEV unit and indoor unit: 5 m
- Outdoor installation: Control unit (IP54 class) and EEV unit can be installed at an outdoor space.

### For 2 EEV units connection (option) Separation Tube: UTP-LX180A



### Connectable capacity

#### • Single connection

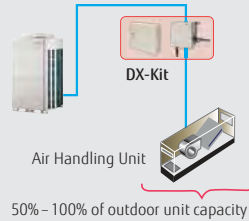

#### • Mixed connection

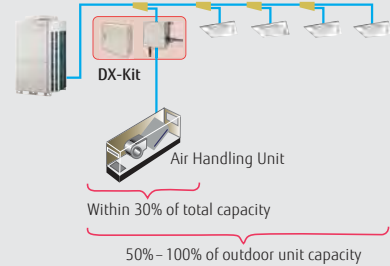

### Piping and wiring length

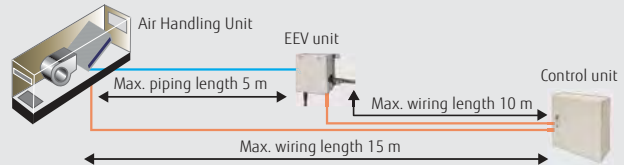

### Control unit: UTY-VDGX

### EEV unit: UTP-VX30A / UTP-VX60A / UTP-VX90A



## Specifications

Connectable Capacity class		5.0 kW	6.3 kW	8.0 kW	10.0 kW	12.5 kW	14.0 kW	20.0 kW	25.0 kW	40.0 kW	50.0 kW
Capacity	Cooling	5.6	6.3	8.0	10.0	12.5	14.0	22.4	25.0	40.0	50.4
	Heating	6.3	7.1	9.0	11.2	14.0	16.0	25.0	28.0	45.0	56.5

Control unit		UTY-VDGX	
Power source	V/Ø/Hz	230/1/50	
Dimensions (H × W × D)	mm	400 × 400 × 120	

EEV unit		UTP-VX30A	UTP-VX60A	UTP-VX90A	UTP-VX90A×2
Connection pipe diameter (Liquid)	mm	Ø9.53	Ø12.70	Ø12.70	Ø12.70
Dimensions (H × W × D)		160 × 220 × 90			

Note: Specifications are based on the following conditions.

Cooling: Indoor temperature of 27°CDB / 19°CWB, and outdoor temperature of 35°CDB / 24°CWB.

Heating: Indoor temperature of 20°CDB / (15°CWB), and outdoor temperature of 7°CDB / 6°CWB.

Pipe length: 7.5 m Voltage: 230 [V].

# DX-Kit

for Air Handling Application  
for Single Split Outdoor Unit



This kit enables other manufacturers air handling units (AHU) and fan coil units (FCU) to be incorporated into a Fujitsu General Split outdoor unit.

## Flexible connectivity

This kit is a control unit to allow connection to third party manufacturer equipment. Fujitsu General single split outdoor units can be used with this control unit, creating an ideal solution when a unique air handling unit is required.

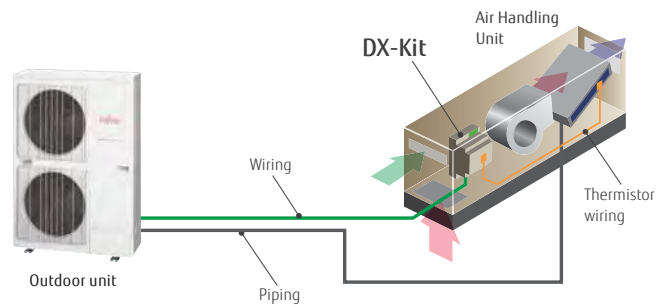

## Supports a wide range of capacity class

Connectable large capacity range: 3.5 kW ~ 22.0 kW (Nominal)



## Operation from anywhere on your mobile device

Available to use operation and management from remote control such as Smartphones and Tablets

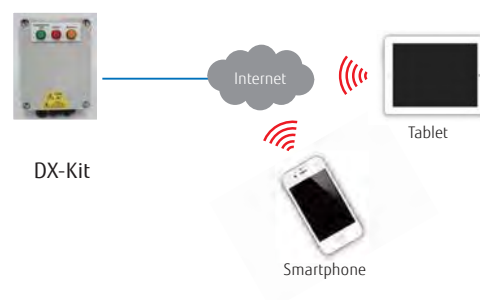

## Functions Summary

## Inputs

- ON/OFF
- Heating/Cooling operation mode
- Capacity demand (analogue 0-10 V)
- Heat exchanger temperature

## Outputs

- Status of Compressor, Defrost, Error (Potential free relays)
- LED status indication

## Wireless LAN Control

Wireless LAN control with cloud connectivity enables safe remote monitoring and control from anywhere.

## Easy installation

- Simple installation through compact DIN rail mountable enclosure
- No need for expansion devise
- No separate external power required



**Model: UTY-XDZXUK**



## Specifications

BTU			12	14	18	24	30	36	45	54	60	72	90
Capacity (Nominal)	Cooling	kW	3.5	4.3	5.2	6.8	8.5	9.4	12.1	13.3	15.0	19.0	22.0
	Heating		4.1	5.0	6.0	7.8	10.0	10.8	13.3	15.8	18.0	22.4	27.0
Model No.		UTY-XDZXUK											
Power source	V/Ø/Hz	230/1/50 (fed from outdoor unit)											
Dimensions (H x W x D)	mm	225 x 155 x 90											
Weight	Kg	0.855											

Note: Specifications are based on the following conditions.

Cooling: Indoor temperature of 27°CDB / 19°CWB, and outdoor temperature of 35°CDB / 24°CWB.

Heating: Indoor temperature of 20°CDB / (15°CWB), and outdoor temperature of 7°CDB / 6°CWB.

Pipe length: 5.0 m Voltage: 230 [V].



# Light Commercial & Commercial AIR HANDLING UNIT

- 238 System Overview
- 240 AIRSTAGE™ Lineup
- 242 Air Handling Units Overview
- 244 Features
  - Structure
  - Filtration
  - Thermal Exchange Sections
  - Fan Section
  - Humidifier
  - Heat Recovery Section
- 250 Dimensions
- 253 Loose Accessories
- 254 Total Pressure Drops Calculation
- 255 Fan Characteristic Curves
- 258 Specifications
- 260 Control System
  - AHU Controller
  - System Controller, System Controller Lite





# System Overview

The Air handling applications for the AIRSTAGE™ system is the Fujitsu general solution to the most demanding installations, where energy efficiency meets with the highest comfort.

The system is composed of AIRSTAGE™ outdoor units from 10 to 54 HP and Air handling unit for civil and industrial buildings for thermo-ventilation and air conditioning purposes, covering air flow ranges from 4,300 to 18,100 m<sup>3</sup>/h and cooling capacities from 25 to 96 kW.



AHU CONTROLLER



SYSTEM CONTROLLER



Controller line

Controller line

Transmission line

Transmission line

Piping line



- For AHU control: AHU controller (Only For AHU)  
 - For mixed connection control: System controller, or 3rd party controller with Modbus convertor



NEW

# AHU

AIR HANDLING UNIT



## The Advantages of the System

### Full comfort

The system offers full comfort and air quality in the buildings providing clean treated air thanks to the advanced filtration and balanced temperature.

### Easy design and installation



The system is simple design and installation. No additional external kit is required as the Air Handling Unit includes DX-kit (Expansion valve and control PCB) AHU model selection is easy by using Selection Software.

### Total solution concept

Integrating an Air Handling Unit into the total building climate system simplifies both design and installation procedures based on a single common technology. From project follow-up to installation, commissioning and maintenance, all procedures are simplified. There is a requirement for not more than one installer.

# AIRSTAGE™ Lineup

Fujitsu General provides multi air conditioning systems for buildings AIRSTAGE™ Series matched to the size and application of the property.

Capacity (kW)		28.0	33.5	40.0	45.0	50.4	55.9	61.5	67.0	73.5	78.5	85.0
HP		10	12	14	16	18	20	22	24	26	28	30
<b>J-IVL Series</b>		 AJY090 LELBH	 AJY108 LELBH	 AJY126 LELBH	 AJY144 LELBH	 AJY162 LELBH						
<b>V-III Series Heat Pump</b>	<b>Space Saving</b>											
	<b>Set Model</b>	AJY090 LALBH	AJY108 LALBH	AJY126 LALBH	AJY144 LALBH	AJY162 LALBH	AJY180 LALBH	AJY198 LALBH	AJY216 LALBH	AJY234 LALBH	AJY252 LALBH	AJY270 LALBH
	<b>Energy Efficiency</b>											
	<b>Set Model</b>			AJY144 LALBHH	AJY162 LALBHH	AJY180 LALBHH		AJY216 LALBHH	AJY234 LALBHH	AJY252 LALBHH	AJY270 LALBHH	























## AIRSTAGE™ J-IVL

for Small Office

Fujitsu General provides air conditioning systems for a wide range of applications from small office buildings and stores to large houses.



90.0	95.0	100.5	107.0	112.0	118.5	123.5	130.0	135.0	140.0	145.0	150.0
32	34	36	38	40	42	44	46	48	50	52	54
 AJY288 LALBH	 AJY306 LALBH	 AJY324 LALBH	 AJY342 LALBH	 AJY360 LALBH	 AJY378 LALBH	 AJY396 LALBH	 AJY414 LALBH	 AJY432 LALBH	 AJY450 LALBH	 AJY468 LALBH	 AJY486 LALBH
 AJY288 LALBHH	 AJY306 LALBHH	 AJY324 LALBHH	 AJY342 LALBHH	 AJY360 LALBHH	 AJY378 LALBHH	 AJY396 LALBHH	 AJY414 LALBHH				



## AIRSTAGE™ V-III

for Large Office

Smart and cutting edge design. Extensive line-up from 10 HP to 54 HP in 2 HP increments. Connectable indoor unit capacity ratio up to 100%

# Air Handling Units Overview

AHU is the range of Air Handling Units for civil and industrial buildings for thermo-ventilation and air conditioning purposes, designed to be connected with AIRSTAGE™ Series Outdoor units.

Units are available in different models and several additional modular sections to meet all installation needs, with air flow ranges varying from 4,300 to 18,100m<sup>3</sup>/h and covering a cooling capacity from 25 to 96kW.

AHU is made of extruded aluminium profiles and nylon angle bars. The "sandwich-type" double-skin panels (50 mm thick) with galvanised sheets, externally pre-painted, and thermal insulation in high density polyurethane foam are fastened on the units by means of an aluminium snap-in locking system.

AHU fan section is equipped with EC Inverter Plug-Fans and is provided with Automatic Regulation Control Systems for Constant Air Flow and Constant Available Static Pressure. An electronic device with pressure sensors on the system and control sensors on EC Plug-Fans adjust the flow rate and the available static pressure to keep the air flow constant.

## 5 configurations are Available

### Configuration A

#### In line with Front Damper

For fresh air operation up to 100% external air

### Configuration B

#### In line with Top Inlet Damper

For fresh air operation up to 100% external air

### Configuration C

#### In line with Inlet Mixing Box

For fresh air operation up to 20% external air

### Configuration D

#### Double Deck with Cross-Flow Heat Exchanger

### Configuration E

#### Double Deck with Thermal Wheel

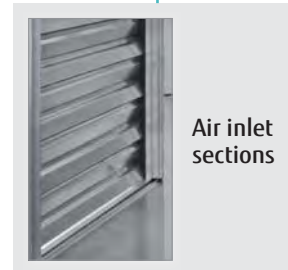
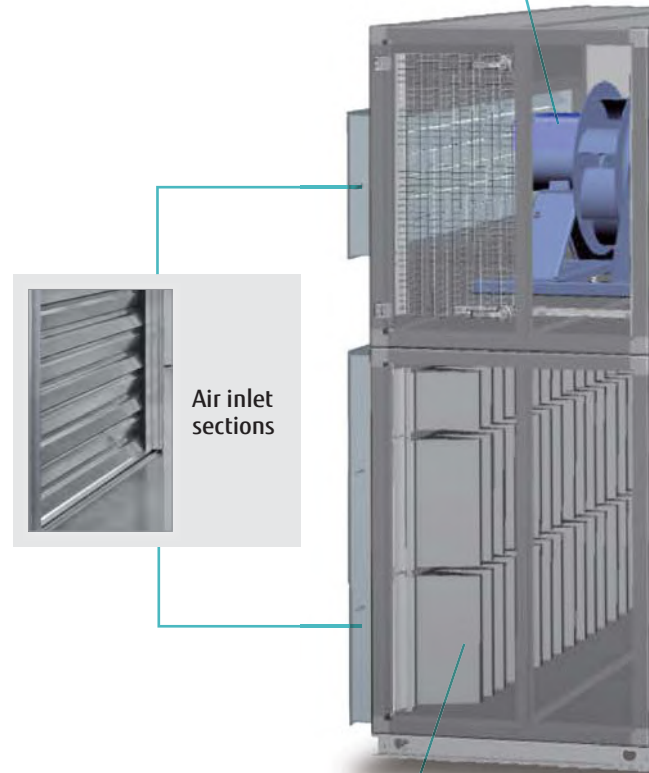
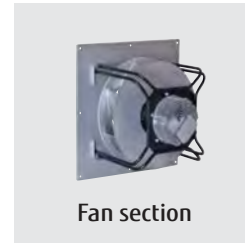



Coil section including built-in expansion valve with PCB control



Electrical heating section

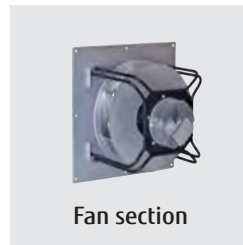

Fan section

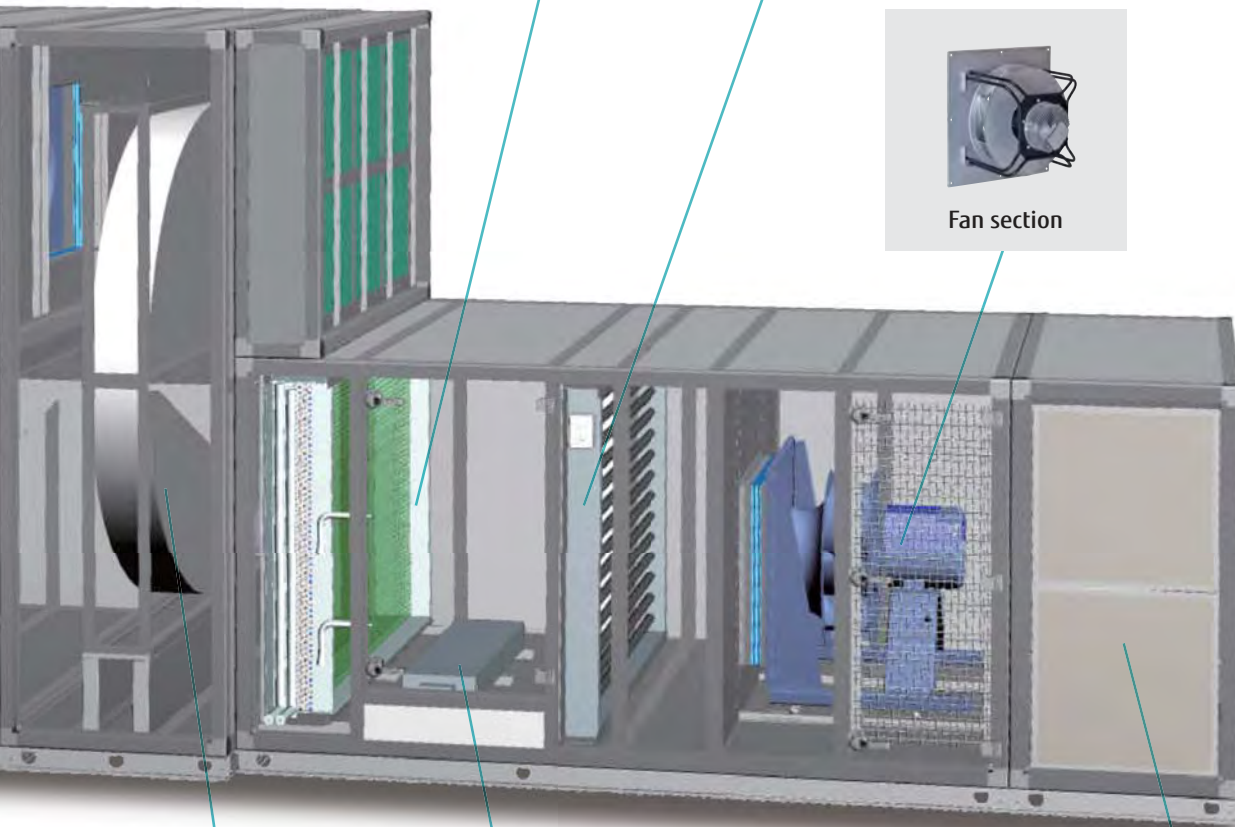
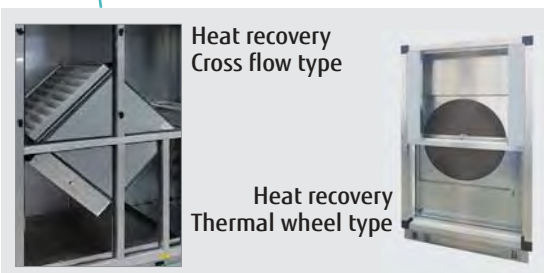

Photo: Configuration E



Humidification sections



Heat recovery Cross flow type

Heat recovery Thermal wheel type

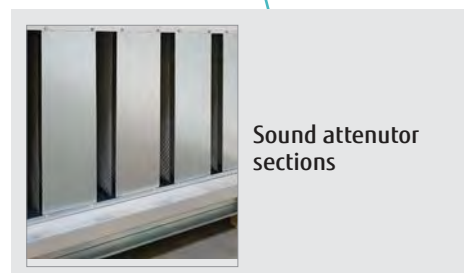

Sound attenuator sections

# Feature

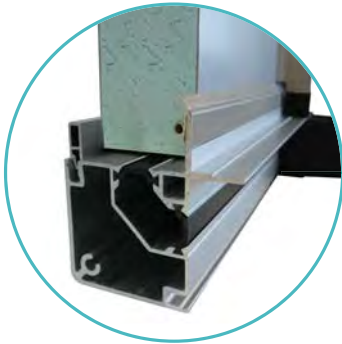

Photo: Configuration C

## Structure

Section of extruded profile 62 × 62 mm (SNAP-IN system)

- The Air Handling Units are manufactured with bearing framework and sandwich paneling.
- The frame is made of extruded anticorrosional aluminium alloy profiles of AlMgSi 0,5- UNI 9006/1 type.

### Mechanical characteristics of extruded aluminium alloy

Denomination	Specific weight (kg/dm <sup>3</sup> )	Unitary load of traction break R (kg/mm <sup>2</sup> )	Yielding load S (0,2) (kg/mm <sup>2</sup> )	Stretch (%)	Brinell hardness (kg/mm <sup>2</sup> )
ANTICORODAL 050 UNI 9006/1 EX UNI 3569 (6060) ISO = Al Mg Si 0.5	2,70	20 ÷ 23	16 ÷ 20	12 ÷ 15	60 ÷ 70

## Profile

- The exclusive bearing structure made by Fujitsu General, having actual dimension of 62 x 62 mm, uses the lock panel system in aluminium (SNAP-IN system). This system permits to reach paneling tightnesses beyond 2500 Pa (10 in WG), because of the homogeneity of the pressure over the paneling perimeter, not achievable with the traditional system (selfdrilling screw fastening). This profile doesn't require the aid of internal and external screws, providing a more solid and aesthetically pleasing appearance.
- Because of the dimensions of the profile, the used panel has actual dimensions of 50 mm.
- The profile hasn't got external sharp edges, as foreseen by the safety and accident-prevention rules in force.
- Air Handling Units are certified for the highest performance standards.



- The EUROVENT certification on Fujitsu General units proves the reliability and correctness of declared performance data and features.
- Fujitsu General units and all internal components are compliant to ErP EcoDesign 2018 LOT6 Regulation.
- The compliance of Fujitsu General units to UNI EN 1886 European Regulation about structure thermal and mechanical performance is also certified by Eurovent.

(Unit : mm)

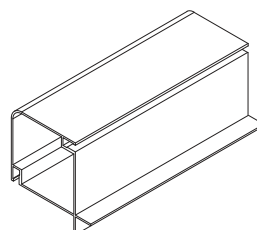
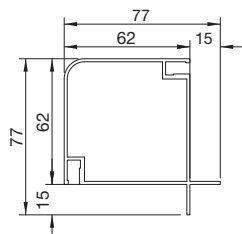

## Panelling

The panelling is double skin sandwich type made of galvanised sheet, with polyurethane foam insulation of minimum density 45 kg/m<sup>3</sup>, actual thickness: -50 mm

### Panels are made as follows:

**Inner skin:** Hot dipped galvanised sheet (galvanisation not less than 140 g/m<sup>2</sup>), 5/10 mm thick.

**Insulation:** Rigid polyurethane foam minimum density 45 kg/m<sup>3</sup>, thermal conductivity 0,018 ÷ 0,024 w/m<sup>2</sup> °c.

**Outer skin:** Hot dipped pre-painted galvanised sheet (galvanisation not less than 140 g/m<sup>2</sup>), 6/10 mm thick.

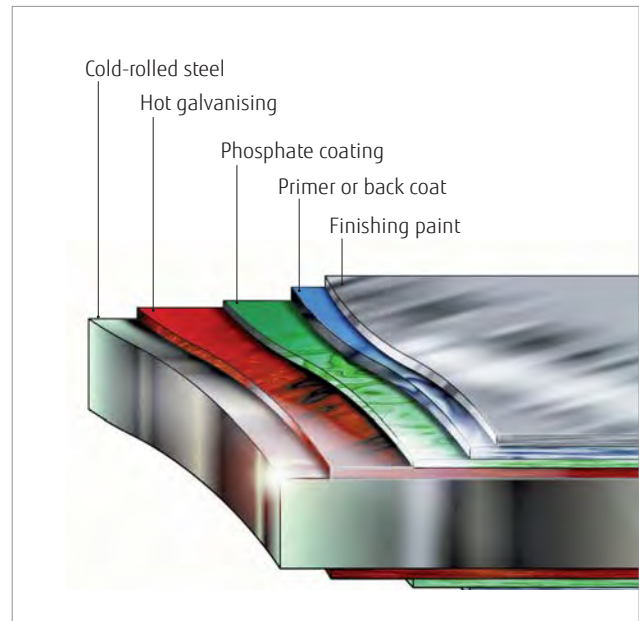

PRE-PAINTED GALVANISED STEEL SHEET

## Steel Sheet Features

Hot dipped galvanised steel sheet type Fe P02 GZ 140 UNI En 10142 with galvanisation not less than 140 g/m<sup>2</sup>. The thickness is 6/10 mm.

Pre-painted steel sheet 6/10 mm thick with base support made of hot dipped galvanised steel (galvanisation not less than 140 g/m<sup>2</sup>) EURONORM 142-79 and coating, colour white-grey for a special resistance to weathering. The protective system consists of a dry film of 25 µm on the exposed skin and of a dry film of 5 µm on the non-exposed skin.

**Hardness of film:** F on the Koh - i - Noor's scale.

### Other chemical-physical characteristics:

- Resistance beyond 250 h in salty mist (ECCA T8)
- Resistance beyond 1000 h in high humidity conditions (ASTM D 714)
- Film resistance to the cleaving and adhesion after bending (ECCA T7).

A self-adhesive PVC film is laid on the steel sheet exposed surface in order to avoid damages during the manufacturing procedures and transport.

## Baseframe

The bearing baseframe is made of galvanised steel with pressure bent, bolted or welded profile, according to the configuration of the unit.

It is arranged for the sections lifting and suitable for water piping passage and drain.

Perimeter baseframes heights and profiles are dimensioned as follows: H = 100 mm with bolted C profile for all units

The baseframes of all the above solutions are made of galvanised steel sheet with minimum thickness 2.0 mm.

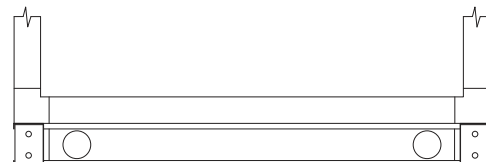

SECTION VIEW.

The baseframe is flush with the panelling

## Covering Roof (TT - Accessory)

- All units that must be positioned outside or generally speaking are exposed to the weather may be equipped with a hot galvanised steel sheet roof (galvanisation not less than 140 g/m<sup>2</sup>) as accessory element.
- The roof overhang with regard to the unit outer dimensions is of about 100 mm.
- All roof corners are equipped with accident prevention corners protections.

## Filtration

Plate Filters COARSE 55%

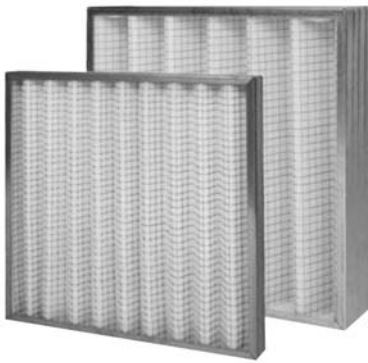

**Plate filters filter the air at a low and medium efficiency.**

- Plate filters are commonly used as prefilters in order to keep a longer efficiency of filters installed downstream.
- Plate filters are installed on guides fastened inside the unit. In this case the air by-pass is minimum.

---

**Plate filters are highly used because of the following features**

- Easy removal
- Easy availability on spare parts market
- Regenerability (they can be washed with warm water and soap or common domestic detergents).

---

**Plate filters are made of**

- Galvanised steel sheet frame 48 mm th.
- Support containing net made of galvanised electrowelded wire
- Filtering material made of synthetic fiber with filtration efficiency COARSE 55%.

---

## Filtration

Bag Filters ePM1 50%



N.B. ePM1 50% bag filters are mandatory for ECODESIGN ErP 2016 compliance

**Bag filters have the characteristic of giving a wide filtering area thanks to their bag shape and therefore they highly reduce the crossing air speed.**

The bags are installed on galvanised slides for side extraction. This filtering section includes the access door.

---

**Soft bag filter features**

- Efficiency, ePM1 50%
- Depth 287 mm
- Fiberglass filtering stuff
- Galvanised steel sheet frame
- 80% of the material is recyclable
- Limit relative humidity 100%.

## Thermal Exchange Sections

### DX Coil



### The section consists of

- DX coil with copper tubes and aluminium fins, specifically designed to guarantee an high thermal exchange and an excellent ratio between sensible and latent heat;
- One distributor and one electronic expansion valve for each circuit connected to its control PCB, which is located in close proximity to avoid every possible interference, immunity and electromagnetic disturbance problems;
- Temperature probes installed at the front, at the rear and in the middle of the coil provide the data to the control PCB, which consequently determines the opening of the electronic expansion valve, depending on the work point and the set point;

On multi-module units the cooling circuits are interlaced to guarantee a full exploitation of the exchange surface and air treated uniformity also at partial loads. The section includes the PCB control.

## Thermal Exchange Sections

### Electrical Heating



Electrical heating section is used for the execution of heating and post-heating treatment

### They are manufactured as follows

- galvanised steel sheet flanged containing frame
- finned steel tubular heaters on base insulators
- safety fix thermostat with manual reset
- electrical heating is foreseen for 3-Stage 400V/3P/50 up to 36 kW capacity.

## Fan Section

EC Inverter Plug-Fan



### The fan section is equipped with EC Inverter Plug-Fan.

- The EC Inverter Plug-Fans are managed by an electronic control adjusting fans rotational speed to adapt air flow and static pressure to the system capacity. They supply a variable air flow according to the requested thermal load, providing important benefits in terms of energy consumption and low noise operation especially when the unit is operating at partial load.
- The EC Inverter Plug-Fans can be set to different working conditions, according to the unit needs, directly on site through the control panel installed on the Electrical Board section.
- Compared to traditional Plug-Fans, thanks to EC Inverter technology the overall efficiency and acoustic behaviour of the fans has been significantly improved. The blade geometry with a diagonal trailing edge has positive effects on the aerodynamic performance and on the running smoothness of the fans. The same is true for the implemented nozzle contour.
- The overall dimension of the section can be kept at minimum thanks to the fan dimension: the EC motor is integrated directly in the impeller. A belt drive between the motor and the fan, which is commonly used otherwise, is not necessary. This reduces the required installation volume and the associated installation effort.
- The EC Plug-Fans significantly exceed the ErP 2015 norm and the requirements of energy efficiency class A+ stated in German manufacturer's association RLT Directive 01, "General Requirements for Ventilation and Air-conditioning Devices".
- AHU fan section equipped with EC Inverter Plug-Fans is provided with the Automatic Regulation Control Systems for Constant Air Flow and Constant Available Static Pressure. An electronic device with pressure sensors on the system and control sensors on EC Plug-Fans adjust the flow rate and the available static pressure to keep the air flow constant.

## Humidifier



### Electrode humidifiers specifically designed for installation inside air handling units.

- The humidifier is constituted by two parts connected together electrically: the hydraulic part and the control unit based on a microprocessor board. The hydraulic part is completely inserted into the AHU, lying on the condensate drain tank immediately downstream of the cooling coil.
- The control is fully integrated in the microprocessor installed aboard the AHU.
- The hydraulic boiler is made up of plastic polypropylene "channel" having a section of 33 cm x 16 cm height, and having a length proportional to the width of the AHU. Inside the boiler are arranged longitudinally the stainless steel electrodes, connected to the power supply phases and easily removable. The lid is made of plastic sections with slope, so as to allow any condensation that falls by gravity into the boiler in order to avoid power losses.
- Between the plastic sections is obtained a narrow longitudinal slot which allows the output of the steam produced, that meets the air for the whole length of the AHU section.
- This solution prevents the formation of condensate in the pipes and also prevents any increase in steam pressure in the boiler due to blockages in the pipes conveying steam.

### On one side of the kettle (the easiest to access once installed) you have the body of hydraulic management of the system

- Maximum water level sensor
- Draining bloc the draining bloc has been specially designed to empty the tank from water and limestone pieces without having to block and having to be able to work without pressure.

A electronic rotation sensor, rigidly grafted on the pivot motor, communicating with the microprocessor which manage the correct operation and shown in the display any faults that may appear.



## Heat Recovery Section

### Cross Flow Heat Recovery



### The recovery unit efficiency has values up to 85%.

- The fixed plates static recovery units are air to air type, without moving parts, therefore working in a reliable and safe way. The air movement is in a crossed flow with heat transfer directly from higher temperature flow to the lower temperature one. The recovery unit efficiency has values up to 85%.
- This type of heat exchanger is made of pressed aluminium sheets, housed in a variable spacing depending on the use type.
- Sealings are made along the edges in order to prevent contamination on renewal air from polluting agents contained in exhaust air.

### The normal supply foresees

- Recovery units with aluminium fins
- Cell prefilters COARSE 55% type (85% eff.) on fresh air side
- Galvanised steel sheet drain pan to collect possible condensation.

## Heat Recovery Section

### Thermal Wheel Recovery Units



### The working principle is the following

- The exhaust air crosses half circular rotor sector and gives part of its heat to the metallic mass. This, slowly wheeling, is invested from cold renewal air crossing in counterflow the other half of the exchanger, taking the heat given from the exhaust air. When the rotor is hygroscopic type, also humidity contained into the exhaust air will be partially transferred to the renewal air.
- The words "warm air" and "cold air" of the above description are valid for winter working cycle; in summer cycle the functions of transfer and absorption of heat and humidity are evidently inverted.

### Usually these type of recovery units are made as follows

- aluminium rotor
- galvanised steel sheet frame
- constant speed electric gearmotor

# Dimensions

## Configurations A

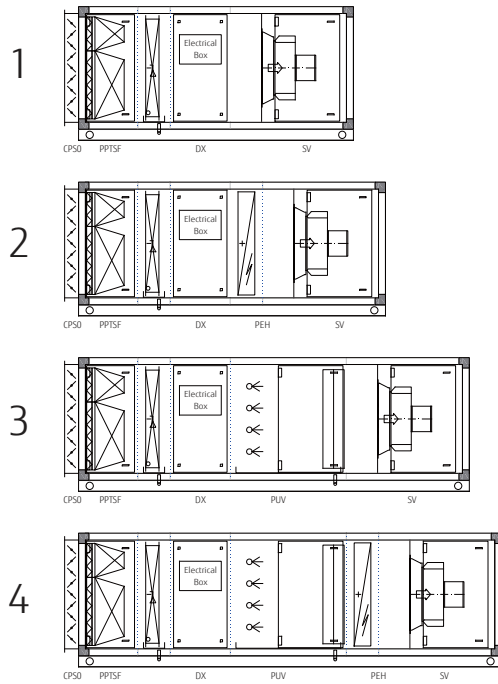

Model name	Config.	H (mm)	W (mm)	L (mm)	kg	L (with silencer) (mm)
AHYA025GWAA	1	1,064	1,154	2,619	611	3,529
AHYA025GWAB	2	1,064	1,154	3,109	679	4,019
AHYA025GWAC	3	1,064	1,154	2,619	629	3,529
AHYA025GWAD	4	1,064	1,154	3,109	697	4,019
AHYA040GWAA	1	1,199	1,354	2,749	844	3,659
AHYA040GWAB	2	1,199	1,354	3,319	931	4,229
AHYA040GWAC	3	1,199	1,354	2,749	865	3,659
AHYA040GWAD	4	1,199	1,354	3,319	952	4,229
AHYA048GWAA	1	1,309	1,574	2,749	921	3,659
AHYA048GWAB	2	1,309	1,574	3,319	1,023	4,229
AHYA048GWAC	3	1,309	1,574	2,749	944	3,659
AHYA048GWAD	4	1,309	1,574	3,319	1,046	4,229
AHYA080GWAA	1	1,544	2,074	3,189	1,542	4,099
AHYA080GWAB	2	1,544	2,074	3,839	1,701	4,749
AHYA080GWAC	3	1,544	2,074	3,189	1,570	4,099
AHYA080GWAD	4	1,544	2,074	3,839	1,729	4,749
AHYA096GWAA	1	1,789	2,250	3,189	1,691	4,099
AHYA096GWAB	2	1,789	2,250	3,839	1,869	4,749
AHYA096GWAC	3	1,789	2,250	3,189	1,724	4,099
AHYA096GWAD	4	1,789	2,250	3,839	1,899	4,749

## Configurations B

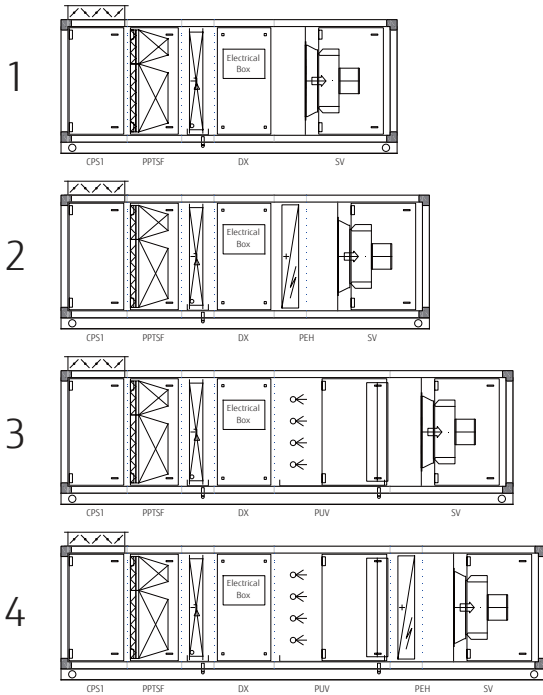

## Configurations C

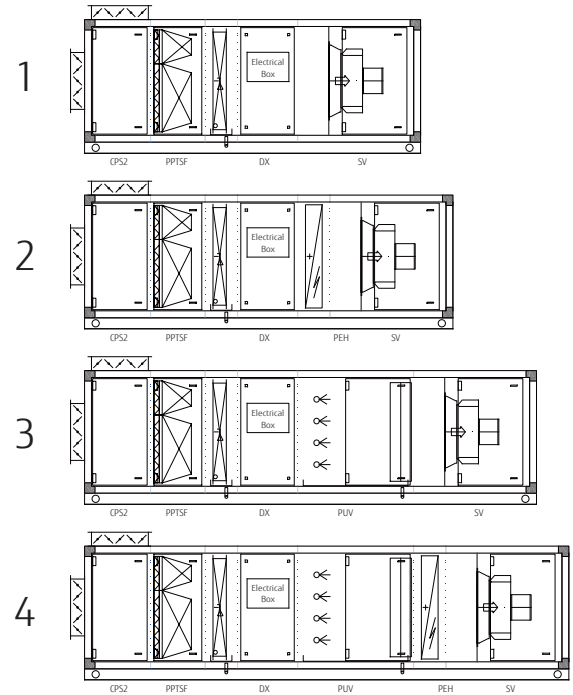

Model name	Config.	H (mm)	W (mm)	L (mm)	kg	L (with silencer) (mm)
AHYB025GWAA	1	1,179	1,154	2,854	628	3,764
AHYB025GWAB	2	1,179	1,154	3,344	696	4,254
AHYB025GWAC	3	1,179	1,154	2,854	646	3,764
AHYB025GWAD	4	1,179	1,154	3,344	714	4,254
AHYB040GWAA	1	1,314	1,354	3,084	873	3,994
AHYB040GWAB	2	1,314	1,354	3,654	960	4,564
AHYB040GWAC	3	1,314	1,354	3,084	894	3,994
AHYB040GWAD	4	1,314	1,354	3,654	981	4,564
AHYB048GWAA	1	1,424	1,574	3,084	953	3,994
AHYB048GWAB	2	1,424	1,574	3,654	1,055	4,564
AHYB048GWAC	3	1,424	1,574	3,084	976	3,994
AHYB048GWAD	4	1,424	1,574	3,654	1,078	4,564
AHYB080GWAA	1	1,659	2,074	3,624	1,591	4,534
AHYB080GWAB	2	1,659	2,074	4,274	1,749	5,184
AHYB080GWAC	3	1,659	2,074	3,624	1,619	4,534
AHYB080GWAD	4	1,659	2,074	4,274	1,777	5,184
AHYB096GWAA	1	1,904	2,250	3,724	1,760	4,634
AHYB096GWAB	2	1,904	2,250	4,374	1,936	5,284
AHYB096GWAC	3	1,904	2,250	3,724	1,790	4,634
AHYB096GWAD	4	1,904	2,250	4,374	1,966	5,284

Model name	Config.	H (mm)	W (mm)	L (mm)	kg	L (with silencer) (mm)
AHYC025GWAA	1	1,179	1,154	2,969	650	3,879
AHYC025GWAB	2	1,179	1,154	3,459	718	4,369
AHYC025GWAC	3	1,179	1,154	2,969	668	3,879
AHYC025GWAD	4	1,179	1,154	3,459	736	4,369
AHYC040GWAA	1	1,314	1,354	3,199	899	4,109
AHYC040GWAB	2	1,314	1,354	3,769	986	4,679
AHYC040GWAC	3	1,314	1,354	3,199	920	4,109
AHYC040GWAD	4	1,314	1,354	3,769	1,007	4,679
AHYC048GWAA	1	1,424	1,574	3,199	980	4,109
AHYC048GWAB	2	1,424	1,574	3,769	1,082	4,679
AHYC048GWAC	3	1,424	1,574	3,199	1,003	4,109
AHYC048GWAD	4	1,424	1,574	3,769	1,105	4,679
AHYC080GWAA	1	1,659	2,074	3,739	1,624	4,649
AHYC080GWAB	2	1,659	2,074	4,389	1,782	5,299
AHYC080GWAC	3	1,659	2,074	3,739	1,652	4,649
AHYC080GWAD	4	1,659	2,074	4,389	1,810	5,299
AHYC096GWAA	1	1,904	2,250	3,839	1,799	4,749
AHYC096GWAB	2	1,904	2,250	4,489	1,975	5,399
AHYC096GWAC	3	1,904	2,250	3,839	1,829	4,749
AHYC096GWAD	4	1,904	2,250	4,489	2,005	5,399

### Configurations D

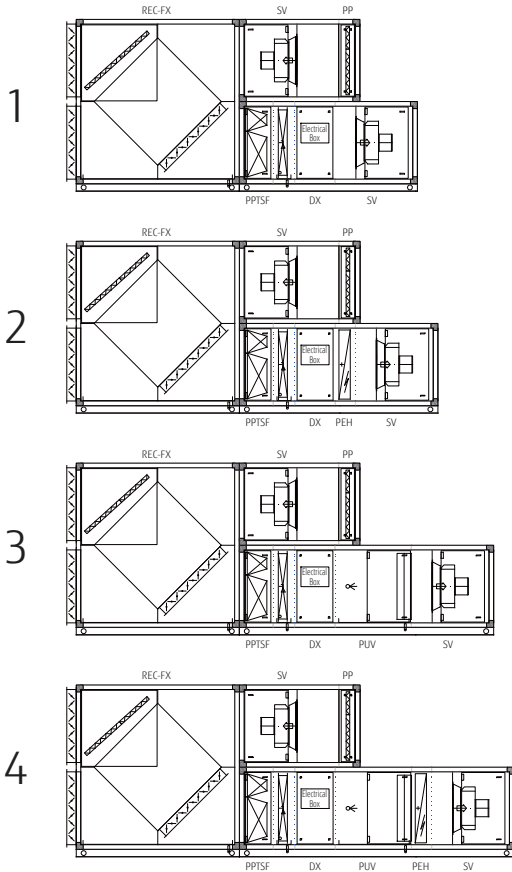

### Configurations E

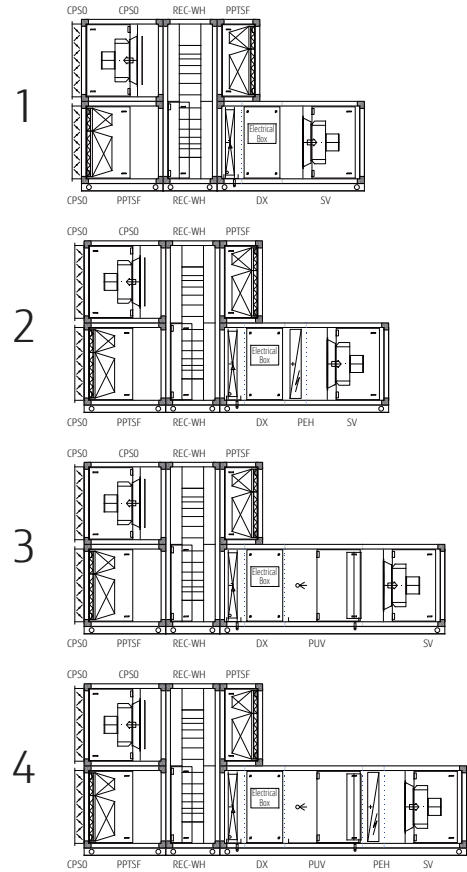

Model name	Config.	H (mm)	W (mm)	L (mm)	kg	L (with silencer) (mm)
AHYD025GWAA	1	2028/1064	1424/1154	4,311	1,259	5,221
AHYD025GWAB	2	2028/1064	1424/1154	4,801	1,327	5,711
AHYD025GWAC	3	2028/1064	1424/1154	4,311	1,277	5,221
AHYD025GWAD	4	2028/1064	1424/1154	4,801	1,345	5,711
AHYD040GWAA	1	2298/1199	1574/1354	4,871	1,750	5,781
AHYD040GWAB	2	2298/1199	1574/1354	5,441	1,837	6,351
AHYD040GWAC	3	2298/1199	1574/1354	4,871	1,771	5,781
AHYD040GWAD	4	2298/1199	1574/1354	5,441	1,858	6,351
AHYD048GWAA	1	2518/1309	1824/1574	4,871	1,978	5,781
AHYD048GWAB	2	2518/1309	1824/1574	5,348	2,080	6,258
AHYD048GWAC	3	2518/1309	1824/1574	4,778	2,001	5,688
AHYD048GWAD	4	2518/1309	1824/1574	5,348	2,103	6,258
AHYD080GWAA	1	2988/1544	2,074	6,161	3,361	7,071
AHYD080GWAB	2	2988/1544	2,074	6,811	3,520	7,721
AHYD080GWAC	3	2988/1544	2,074	6,161	3,389	7,071
AHYD080GWAD	4	2988/1544	2,074	6,811	3,548	7,721
AHYD096GWAA	1	3478/1789	2,250	6,451	3,849	7,361
AHYD096GWAB	2	3478/1789	2,250	7,008	4,025	7,918
AHYD096GWAC	3	3478/1789	2,250	6,451	3,879	7,268
AHYD096GWAD	4	3478/1789	2,250	7,008	4,055	7,918

Model name	Config.	H (mm)	W (mm)	L (mm)	kg	L (with silencer) (mm)
AHYE025GWAA	1	2028/1064	1429/1154	3,813	1,150	4,723
AHYE025GWAB	2	2028/1064	1429/1154	4,303	1,226	5,213
AHYE025GWAC	3	2028/1064	1429/1154	3,813	1,168	4,723
AHYE025GWAD	4	2028/1064	1429/1154	4,303	1,244	5,213
AHYE040GWAA	1	2298/1199	1729/1354	4,073	1,571	4,983
AHYE040GWAB	2	2298/1199	1729/1354	4,643	1,658	5,553
AHYE040GWAC	3	2298/1199	1729/1354	4,073	1,592	4,983
AHYE040GWAD	4	2298/1199	1729/1354	4,643	1,679	5,553
AHYE048GWAA	1	2518/1309	1829/1574	4,073	1,696	4,983
AHYE048GWAB	2	2518/1309	1829/1574	4,643	1,798	5,553
AHYE048GWAC	3	2518/1309	1829/1574	4,073	1,719	4,983
AHYE048GWAD	4	2518/1309	1829/1574	4,643	1,821	5,553
AHYE080GWAA	1	2988/1544	2374/2074	4,953	2,753	5,863
AHYE080GWAB	2	2988/1544	2374/2074	5,603	2,912	6,513
AHYE080GWAC	3	2988/1544	2374/2074	4,953	2,781	5,863
AHYE080GWAD	4	2988/1544	2374/2074	5,603	2,940	6,513
AHYE096GWAA	1	3478/1789	2582/2250	4,953	3,035	5,863
AHYE096GWAB	2	3478/1789	2582/2250	5,603	3,211	6,513
AHYE096GWAC	3	3478/1789	2582/2250	4,953	3,065	5,863
AHYE096GWAD	4	3478/1789	2582/2250	5,603	3,241	6,513

## Silencer PI

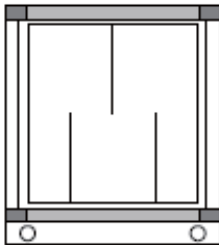

## Loose Accessories

### Galvanised metal sheet roof

All units that must be positioned outside or generally speaking are exposed to the weather may be equipped with a hot-galvanised metal sheet roof (galvanisation not less than 140 g/m<sup>2</sup>) an accessory element.

The roof overhang with regard to the unit outer dimensions is of about 100 mm. All roof corners are equipped with accident prevention protections.

Connectable AHU model name	H (mm)	L (mm)	W (mm)	Kg
AHY* 025GWA*	1064	910	1154	209
AHY* 040GWA*	1199	910	1354	233
AHY* 048GWA*	1309	910	1574	274
AHY* 080GWA*	1544	910	2074	280
AHY* 096GWA*	1789	910	2250	444

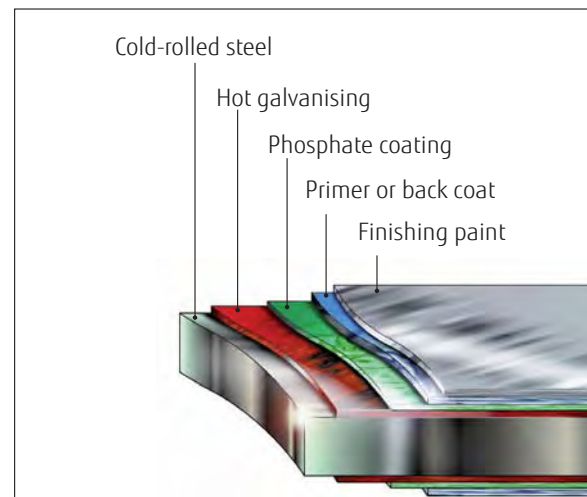

# Total Pressure Drops Calculation

**AHU units, being controlled by EC Inverter Plug-Fans, can satisfy a high range of required air flow rate and static pressure.**

The EC Inverter Plug-Fans can be set to different working conditions, according to the unit needs, directly on site through the control panel installed on the Electrical Board section.

## Procedure for selection

- Select the AHU model most suitable according the air volume.
- Check the air flow static pressure operating point on the curve of the chosen fan by crossing the required air flow rate with the value of the overall static pressure.

To calculate the total static pressure value refer to the Components Pressure Drop table and add the net static pressure required for the plant.



## Components Pressure Drop table

ODU	AHU SIZE	MIN NOM MAX	Airflow	Inlet damper (Config. A-E)	Inlet damper (Config. B-C)	COARSE 55% filters - supply	ePM1 50% filters	DX coil	Silencer	PHE + dampers + COARSE 55% filters-supply	PHE + damper -exhaust	COARSE 55% filters - exhaust (Config. D)	Heat wheel - supply	COARSE 55% filters - supply (Config. E)	ePM1 50% filters (Config. E)	Heat wheel - exhaust	COARSE 55% filters - exhaust (Config. E)	Exhaust damper (Config. E)	Humidifier	Electrical heater
			m³/h	Pa	Pa	Pa	Pa	Pa	Pa	Pa	Pa	Pa	Pa	Pa	Pa	Pa	Pa	Pa	Pa	Pa
10HP	025	MIN	4,300	1	12	91	156	55	26	206	120	91	162	93	144	159	84	7	-	-
		NOM	4,500	1	13	98	158	59	28	210	122	95	167	93	146	165	95	8	-	-
		MAX	5,000	2	16	99	164	71	36	235	147	96	187	95	150	185	96	10	-	-
14HP	040	MIN	5,000	1	4	91	138	37	4	154	70	91	116	89	135	114	91	4	-	-
		NOM	7,200	2	13	87	149	68	10	240	145	87	172	93	144	169	94	8	-	-
		MAX	8,000	2	16	96	153	82	12	243	165	96	193	94	147	190	96	9	-	-
18HP	048	MIN	8,100	1	12	96	153	50	10	225	139	92	167	94	147	165	92	9	-	-
		NOM	8,600	1	13	97	156	55	11	241	155	93	178	95	149	176	93	10	-	-
		MAX	9,100	2	15	98	159	60	13	257	171	93	189	95	152	187	93	11	-	-
2X 14HP	080	MIN	11,000	1	8	91	140	30	9	148	62	90	121	90	137	119	90	6	-	-
		NOM	14,500	2	14	94	148	47	16	188	101	93	163	93	143	161	93	10	-	-
		MAX	16,100	2	17	96	153	56	19	209	122	94	183	94	147	180	94	13	-	-
2X 18HP	096	MIN	16,000	1	10	96	152	37	16	157	74	91	146	92	142	144	91	10	-	-
		NOM	17,300	1	11	97	156	42	19	168	86	92	159	93	145	157	92	11	-	-
		MAX	18,100	1	13	98	158	46	21	175	93	92	167	93	146	165	92	13	-	-

# Fan Characteristic Curves

## Fan type 400 mm

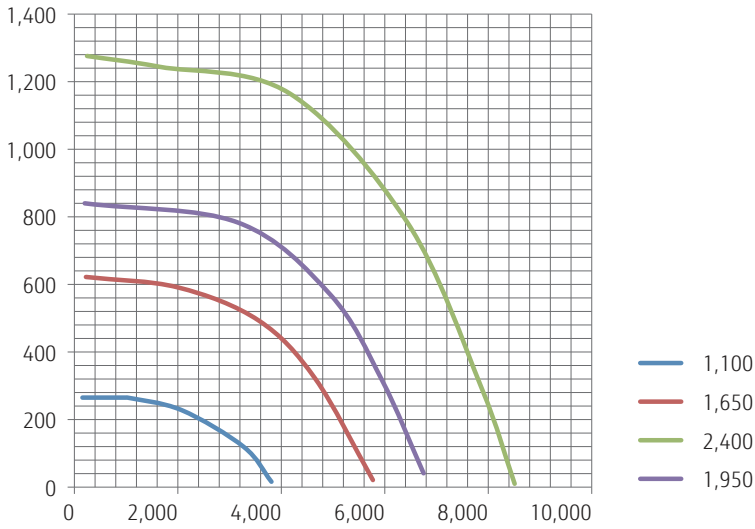

fan type	m³/h	Pa Total static pressure	W	n	LwAin	LwAout
				[1/min]	[dB]	[dB]
400 mm	156	265	124	1100	63	71
400 mm	334	265	134	1100	63	70
400 mm	1002	265	187	1100	62	69
400 mm	1025	265	181	1100	62	69
400 mm	2072	228	234	1100	58	66
400 mm	3275	119	224	1100	62	69
400 mm	3809	16	173	1100	69	74
400 mm	223	622	352	1650	75	82
400 mm	2005	591	642	1650	72	79
400 mm	3564	493	767	1650	68	75
400 mm	4656	321	708	1650	71	77
400 mm	5770	21	487	1650	79	83
400 mm	200	840	509	1950	79	86
400 mm	3163	783	1154	1950	74	81
400 mm	4946	570	1223	1950	74	80
400 mm	5948	316	1027	1950	78	83
400 mm	6750	41	773	1950	83	87
400 mm	245	1276	921	2400	85	92
400 mm	1649	1244	1497	2400	86	92
400 mm	4163	1165	2223	2400	81	87
400 mm	6438	783	2237	2400	81	87
400 mm	7864	296	1738	2400	86	91
400 mm	8510	10	1389	2392	89	93

## Fan type 560 mm

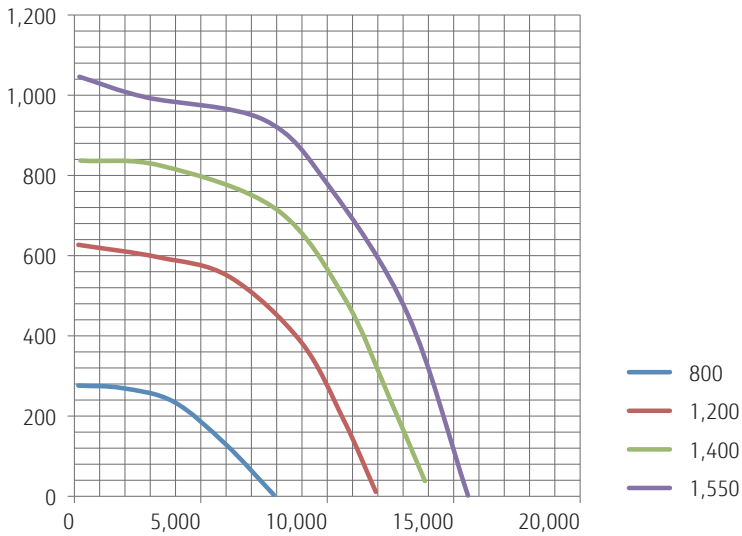

fan type	m³/h	Pa Total static pressure	W	n	LwAin	LwAout
				[1/min]	[dB]	[dB]
560 mm	158	276	209	800	65	72
560 mm	1861	270	345	800	65	71
560 mm	3921	236	438	800	61	67
560 mm	5980	130	452	800	62	67
560 mm	7881	4	313	800	69	74
560 mm	158	627	591	1200	77	83
560 mm	3327	596	1164	1200	75	82
560 mm	6139	547	1471	1200	71	77
560 mm	8950	386	1473	1200	72	78
560 mm	10653	190	1212	1200	76	82
560 mm	11921	11	936	1200	80	85
560 mm	238	837	901	1400	80	87
560 mm	3446	824	1743	1400	80	87
560 mm	8000	715	2403	1400	75	81
560 mm	10693	493	2260	1400	76	82
560 mm	12475	243	1859	1400	80	86
560 mm	13861	38	1521	1400	85	89
560 mm	198	1046	1210	1550	84	90
560 mm	2812	995	2086	1550	84	91
560 mm	7485	939	3131	1550	78	84
560 mm	10059	774	3249	1550	77	84
560 mm	13188	453	2901	1550	82	88
560 mm	15564	2	1948	1550	91	94



## Fan type 710 mm

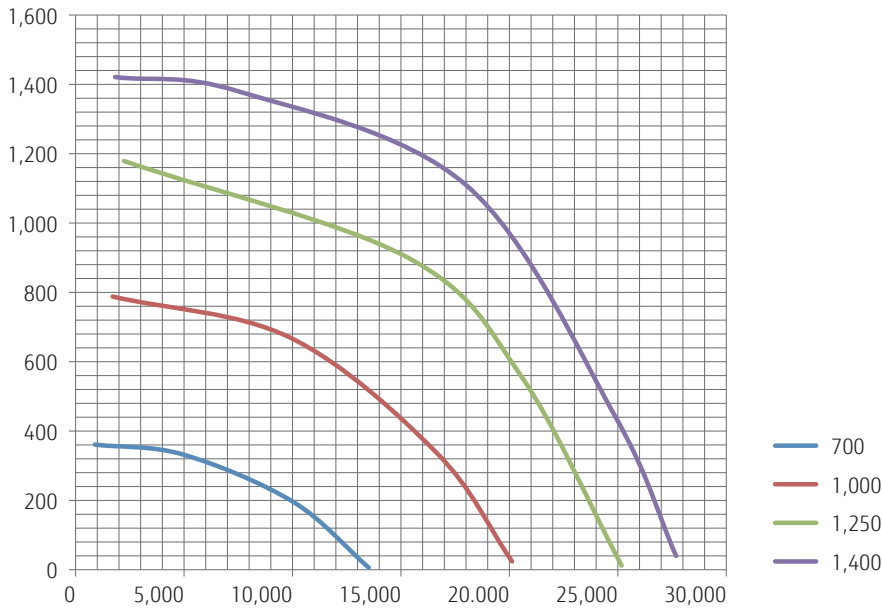

fan type	m <sup>3</sup> /h	Pa Total static pressure	W	n	LwAin	LwAout
				[1/min]	[dB]	[dB]
710 mm	891	361	744	700	71	77
710 mm	4975	332	1290	700	69	74
710 mm	10025	196	1427	700	69	75
710 mm	13515	6	880	700	77	83
710 mm	1708	788	1693	1000	81	88
710 mm	9876	670	3179	1000	77	83
710 mm	16634	338	3084	1000	80	86
710 mm	20124	24	2177	1000	87	93
710 mm	2228	1179	3015	1250	87	94
710 mm	15297	901	6054	1250	83	89
710 mm	20495	563	5794	1250	86	92
710 mm	25173	12	3857	1250	92	98
710 mm	1821	1421	3716	1400	89	96
710 mm	7500	1380	5851	1400	89	95
710 mm	17996	1110	8301	1400	86	92
710 mm	24855	445	6916	1400	91	98
710 mm	27685	40	5271	1400	95	101

# Specifications

### Configuration A-B-C

Model FG		025	040	048	080	096
Model name		AHYA025GWA* AHYB025GWA* AHYC025GWA*	AHYA040GWA* AHYB040GWA* AHYC040GWA*	AHYA048GWA* AHYB048GWA* AHYC048GWA*	AHYA080GWA* AHYB080GWA* AHYC080GWA*	AHYA096GWA* AHYB096GWA* AHYC096GWA*
Casing						
Material		Outer skin in 0.6 mm pre-painted galvanised sheet; inner skin in 0.6 mm galvanised sheet				
Insulation		PU foam, 50 mm thickness, 45 kg/m <sup>3</sup>				
Performances						
Cooling capacity	kW	25	40	48	78	96
Heating capacity	kW	31.5	45	50	81.5	100
Available static pressure	Pa	200	200	200	200	200
Power supply	W/Ph/Hz	400/3/50	400/3/50	400/3/50	400/3/50	400/3/50
Air flow						
Max	m <sup>3</sup> /h	5000	8000	9100	16100	18100
Rated	m <sup>3</sup> /h	4500	7200	8600	14500	17300
Min	m <sup>3</sup> /h	4300	5000	8100	11000	16000
Cross flow heat recovery						
Efficiency (*)	%	—	—	—	—	—
Eurovent Energy Class (**)						
Rated		A+	A	A	A	A
DX Coil						
Rows	n°	4				
Coil type		25x22 - 3/8"				
Coil duty		Cooling - Heating				
Fluid		R410A				
Pipes material		Copper				
Fins material		Aluminium				
Electrical heating						
Stages	n°	3				
Heating capacity	kW	9	15	18	30	36
Humidifier						
Fix steam capacity	kg/h	15	25	30	45	60
Fan						
Type		EC Plug Fan				
Motor data	mm	400	560	560	710	710
	kW	2.4	3.4	3.4	7.3	7.3
Thermal transmittance of the casing(TT) class		T3	T3	T3	T3	T3
Thermal bridging factor(TBF) class		TB3	TB3	TB3	TB3	TB3
Casing strength(CS) class		D2(M)	D2(M)	D2(M)	D2(M)	D2(M)
Casing air leakage(CAL) class@-400Pa		L2(M)	L2(M)	L2(M)	L2(M)	L2(M)
Casing air leakage(CAL) class@+700Pa		>L3(M)	>L3(M)	>L3(M)	>L3(M)	>L3(M)
Filter bypass leakage (FBL) class		F9(M)	F9(M)	F9(M)	F9(M)	F9(M)

(\*) at rated air flow  
(\*\*) configuration 1

Model FG	
Model name	
Casing	
Material	
Insulation	
Performances	
Cooling capacity	kW
Heating capacity	kW
Available static pressure	Pa
Power supply	W/Ph/Hz
Air flow	
Max	m <sup>3</sup> /h
Rated	m <sup>3</sup> /h
Min	m <sup>3</sup> /h
Heat recovery	
Efficiency (*)	%
Eurovent Energy Class (**)	
Rated	
DX Coil	
Rows	n°
Coil type	
Coil duty	
Fluid	
Pipes material	
Fins material	
Electrical heating	
Stages	n°
Heating capacity	kW
Humidifier	
Fix steam capacity	kg/h
Fan	
Type	
Motor data	mm
	kW
Thermal transmittance of the casing(TT) class	
Thermal bridging factor(TBF) class	
Casing strength(CS) class	
Casing air leakage(CAL) class@-400Pa	
Casing air leakage(CAL) class@+700Pa	
Filter bypass leakage (FBL) class	

**Configuration D**

025	040	048	080	096
AHYD025GWA*	AHYD040GWA*	AHYD048GWA*	AHYD080GWA*	AHYD096GWA*
Outer skin in 0,6 mm pre-painted galvanised sheet; inner skin in 0,6 mm galvanised sheet				
PU foam, 50 mm thickness, 45 kg/m <sup>3</sup>				
25	40	48	78	96
31.5	45	50	81.5	100
200	200	200	200	200
400/3/50	400/3/50	400/3/50	400/3/50	400/3/50
5000	8000	9100	16100	18100
4500	7200	8600	14500	17300
4300	5000	8100	11000	16000
73.3	74.4	74.2	73.7	73.6
A+	A+	A+	A+	A
4				
25x22 - 3/8"				
Cooling - Heating				
R410A				
Copper				
Aluminium				
3				
9	15	18	30	36
15	25	30	45	60
EC Plug Fan				
2.4	3.4	3.4	7.3	7.3
T3	T3	T3	T3	T3
TB3	TB3	TB3	TB3	TB3
D2(M)	D2(M)	D2(M)	D2(M)	D2(M)
L2(M)	L2(M)	L2(M)	L2(M)	L2(M)
>L3(M)	>L3(M)	>L3(M)	>L3(M)	>L3(M)
F9(M)	F9(M)	F9(M)	F9(M)	F9(M)

**Configuration E**

025	040	048	080	096
AHYE025GWA*	AHYE040GWA*	AHYE048GWA*	AHYE080GWA*	AHYE096GWA*
Outer skin in 0,6 mm pre-painted galvanised sheet; inner skin in 0,6 mm galvanised sheet				
PU foam, 50 mm thickness, 45 kg/m <sup>3</sup>				
25	40	48	78	96
31.5	45	50	81.5	100
200	200	200	200	200
400/3/50	400/3/50	400/3/50	400/3/50	400/3/50
5000	8000	9100	16100	18100
4500	7200	8600	14500	17300
4300	5000	8100	11000	16000
75.6	74.7	74.2	75.3	75.6
A+	A+	A+	A	A
4				
25x22 - 3/8"				
Cooling - Heating				
R410A				
Copper				
Aluminium				
3				
9	15	18	30	36
15	25	30	45	60
EC Plug Fan				
2.4	3.4	3.4	7.3	7.3
T3	T3	T3	T3	T3
TB3	TB3	TB3	TB3	TB3
D2(M)	D2(M)	D2(M)	D2(M)	D2(M)
L2(M)	L2(M)	L2(M)	L2(M)	L2(M)
>L3(M)	>L3(M)	>L3(M)	>L3(M)	>L3(M)
F9(M)	F9(M)	F9(M)	F9(M)	F9(M)

(\*) at rated air flow  
 (\*\*) configuration I

# Control System

AHU units include built-in electrical panel and expansion valve with PCB control. Set point is fixed via standard wired control.

The cooling load is determined by the air return temperature and set point on the wired control.

## AHU Controller

UTY-TXUX



### Features

- Easy to install. Control connects to AHU PLC.
- Able to install the control after building decoration.
- Mode lock function: user can lock the running mode of Air Handling Unit.

### Easy Opration

The remote controller realised an intuitive operation feeling by touch panel operation.

### Functions

- Schedule setting change
- Set temperature and humidity
- Ambient's name
- Alarms setting
- Event setting

### Specifications

Model name		UTY-TXUX
Format	mm	120 x 86 x 25
Display		Display touch color 3.5" 320 x 240
Power supply		24 Vac - 24 Vac/dc
Analogue inputs		1 x Integrated NTC
Connectivity		RS485 - Modbus SL, USB Micro-B (debug and programming)
Operating temperature		0 - +50 °C

# System Controller

UTY-APGXZ1 Software

## Features

System Controller realises the advanced integrated monitoring & control of VRF network system from small scale buildings to large scale buildings.

- Up to a maximum of 4 VRF network systems, 1,600 indoor units, and 400 outdoor units can be controlled.
- In addition to air conditioning precision control function, central remote control, electricity charge calculation, schedule management, and energy saving functions are strengthened and building manager and owner needs are met.

Max. Controllable

**4** VRF network systems

Max. Controllable

**400** outdoor units

Max. Controllable

**1,600** indoor units

# System Controller Lite

UTY-ALGXZ1 + UTY-PLGXX2 Software

## Features

System Controller Lite has standard functions sufficient for air conditioner management in small and medium scale buildings.

- Up to a maximum of 1 VRF network system, 400 indoor units, and 100 outdoor units can be controlled.
- In addition to air conditioning precision control function, a variety of management software is available as an option to give customers a wide range of choice.

Max. Controllable

**1** VRF network systems

Max. Controllable

**100** outdoor units

Max. Controllable

**400** indoor units



It is possible to perform centralised control to stop the operation of lighting and ventilation equipment in addition to air conditioners. This is useful in energy saving management over the whole building.



Functions Summary

Function	Type	System controller		System controller lite					
		UTY-APGXZ1	Option UTY-PEGXZ1	UTY-ALGXZ1	Option UTY-PLGXR2	Option UTY-PLGXA2	Option UTY-PLGXE2	Option UTY-PLGXX2	
System specification	Max. VRF networks supported	4	-	1	-	-	-	-	
	Max. indoor unit / remote controller groups per VRF network	400	-	400	-	-	-	-	
	Max. outdoor units per VRF network	100	-	100	-	-	-	-	
	Max. indoor units / remote controller groups per System controller	1600	-	400	-	-	-	-	
Site supervision	Max. outdoor units per System controller	400	-	100	-	-	-	-	
	Multi site display	10	-	10	-	-	-	-	
	Number of building / 1 site	20	-	-	-	-	-	-	
	Number of floor per 1 site	200	-	-	-	-	-	-	
	Number of floor per 1 building	50	-	-	-	-	-	-	
	3D graphical layout view	●	-	-	-	-	-	-	
	2D graphical layout view	●	-	-	-	-	-	-	
	List display	●	-	●	-	-	-	-	
	Tree display	●	-	●	-	-	-	-	
Error management	Group display	●	-	●	-	-	-	-	
	Error notification	●	-	●	-	-	-	-	
	Audible alarm	●	-	●	-	-	-	-	
History	Error e-mail notification	●	-	●	-	-	-	-	
	Error history	●	-	●	-	-	-	-	
Operation control	Operation history	●	-	●	-	-	-	-	
	Control history	●	-	●	-	-	-	-	
	Individual control	On/Off	●	-	●	-	-	-	-
		Operation mode*	●	-	●	-	-	-	-
		Room temperature	●	-	●	-	-	-	-
		Fan speed	●	-	●	-	-	-	-
		Air flow direction	●	-	●	-	-	-	-
		Economy mode	●	-	●	-	-	-	-
		Room temperature set point limitation	●	-	●	-	-	-	-
	Individual management	Antifreeze	●	-	●	-	-	-	-
		Outdoor unit low noise setting	●	-	●	-	-	-	-
		Remote control prohibition setting	●	-	●	-	-	-	-
	Other	Temperature upper and lower limit setting	●	-	●	-	-	-	-
		Filter sign reset	●	-	●	-	-	-	-
Memory operation		●	-	●	-	-	-	-	
Schedule	Pattern operation	●	-	●	-	-	-	-	
	Annual Schedule	●	-	●	-	-	-	-	
	Special day setting	●	-	●	-	-	-	-	
	On / off per day	72	-	72	-	-	-	-	
	On / off per week	504	-	504	-	-	-	-	
	Day off	●	-	●	-	-	-	-	
	Min. unit of timer setting (Minutes)	10	-	10	-	-	-	-	
Remote management	Low noise mode Weekly schedule	●	-	●	-	-	-	-	
	Web Operation	●	-	●	-	-	-	-	
	Remote monitoring	●	-	-	●	-	-	-	
Electricity charge apportionment	Remote operation control	●	-	-	●	-	-	-	
	Remote function setting	●	-	-	●	-	-	-	
	Apportionment charge/bill calculation	●	-	-	-	●	-	-	
	Tenant (block) setting	●	-	-	-	●	-	-	
	Common facilities apportionment setting	●	-	-	-	●	-	-	
Energy saving management	Rated power consumption allotment setting	●	-	-	-	●	-	-	
	Individual calculation at cooling and heating	-	●	-	-	●	-	-	
	Electricity meter supported	-	●	-	-	●	-	-	
	Indoor unit rotation	-	●	-	-	-	●	-	
	Peak cut control	-	●	-	-	-	●	-	
	Outdoor unit capacity save	-	●	-	-	-	●	-	
External Device Control	Record of energy saving operation	-	●	-	-	-	●	-	
	Energy saving information	-	●	-	-	-	●	-	
	Power consumption monitor	-	●	-	-	-	●	-	
Others	Electricity meter supported	-	●	-	-	-	●	-	
	Monitor	●	-	-	-	-	-	●	
	Control	●	-	-	-	-	-	●	
	Database import/export	●	-	●	-	-	-	-	
	Automatic clock adjustment	●	-	●	-	-	-	-	
Others	Multi language	7 languages	-	7 languages	-	-	-	-	
	Refrigerant leakage detection function	●	-	●	-	-	-	-	
	Power shutdown	●	-	●	-	-	-	-	

●●: Available. -: Not available.

### Personal Computer System Requirements

The required PC specifications are shown in the following table.

	System Controller	System Controller Lite
Operating system	<ul style="list-style-type: none"> <li>• Microsoft® Windows® 7 Home Premium (32-bit or 64-bit) SP1, Windows® 7 Professional (32-bit or 64-bit) SP1</li> <li>• Microsoft® Windows® 8.1 (32-bit or 64-bit), Windows® 8.1 Pro (32-bit or 64-bit)</li> <li>• Microsoft® Windows® 10 Home (32-bit or 64-bit), Windows® 10 Pro (32-bit or 64-bit)</li> </ul> [Supported languages] English, Chinese, French, German, Russian, Spanish, and Polish	
CPU	Intel® Core™ i3 2 GHz or higher	
Memory	<ul style="list-style-type: none"> <li>• 2 GB or more (for Windows® 7 [32-bit])</li> <li>• 4 GB or more (for Windows® 7 [64-bit], Windows® 8.1, and Windows® 10)</li> </ul>	
HDD	40 GB or more of free space	
Display	1024 x 768 or higher resolution	
Interface	<ul style="list-style-type: none"> <li>• Ethernet port (for getting access to the Internet using LAN) or Modem (for getting access to the Internet using Public Telephone Line)</li> <li>• USB ports (Maximum of 6 ports) (Required only for the Server PC that works as VRF Controller)</li> <li>- Maximum of 2 USB ports are required for WHITE-USB-KEY/WibuKey connection</li> <li>- Maximum of 4 USB ports are required for Echelon® U10 USB Network Interface</li> <li>* Maximum number of required USB port depends on the applicable system configuration.</li> </ul>	<ul style="list-style-type: none"> <li>• Ethernet port (for getting access to the Internet using LAN) or Modem (for getting access to the Internet using Public Telephone Line)</li> <li>• USB ports (Maximum of 6 ports) (Required only for the Server PC that works as VRF Controller)</li> <li>- Maximum of 4 USB ports are required for WHITE-USB-KEY/WibuKey connection</li> <li>- 1 USB port is required for Echelon® U10 USB Network Interface</li> <li>* The maximum number of required USB port depends on the applicable system configuration.</li> </ul>
Graphic accelerator	Microsoft® DirectX® 9.0c compatible	
Software	Adobe® Reader® 9.0 or later	

• Echelon® U10 USB Network Interface - TP/FT-10 Channel (Model number: 75010R) (Required for each VRF Network.)

### Packing List

Type	For System controller		For System controller Lite				
	System Controller	Option Energy manager	System Controller Lite	Remote access	Option Electricity charge apportionment	Energy saving	Central Control
Model name	UTY-APGXZ1	UTY-PEGXZ1	UTY-ALGXZ1	UTY-PLGXR2	UTY-PLGXA2	UTY-PLGXE2	UTY-PLGXX2
WHITE-USB-KEY	1	1	1	1	1	1	1

\*1: Software protection key to be inserted in a USB slot running System Controller or System Controller Lite.  
System Controller or System Controller Lite may only run on a PC with WHITE-USB-KEY. However, WHITE-USB-KEY is not required for remote VRF Explorer software.

## Notice for specifications

I.U. = Indoor Unit O.U. = Outdoor Unit Qu = Quiet \* = Not decided yet

- Specifications and design are subject to change without notice for future improvement.
- For further details, please check with our authorised dealer.
- Cooling/Heating capacities are based on the following conditions.

Cooling	Indoor temp. : 27°C DB/19°C WB Outdoor temp.: 35°C DB/24°C WB	Heating	Indoor temp. : 20°C DB Outdoor temp.: 7°C DB/6°C WB
---------	--	---------	--

UK Cooling Conditions	Indoor temp. : 23°C DB/16°C WB Outdoor temp.: 35°C	UK Heating Conditions	Indoor temp. : 20°C DB Outdoor temp.: 0°C DB/-2°C WB
-----------------------	---	-----------------------	---

- Performance test is in accordance with EN14511
- Seasonal efficiency test is on accordance with EN14825
- Sound power test is in accordance with EN12102



Fujitsu General (Thailand) Co., Ltd.

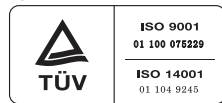

ISO 9001 Certified number: 01 100 075229  
ISO 14001 Certified number: 01 104 9245

Fujitsu General (Shanghai) Co., Ltd.



ISO 9001 Certified number: 01 100 79269  
ISO 14001 Certified number: CNB312244-UK

Fujitsu General Central Air-conditioner (Wuxi) Co., Ltd.



ISO 9001 Certified number: 15917020073R5M  
ISO 14001 Certified number: 15918E20021R5M

- The products or equipments in this catalogue contain fluorinated greenhouse gases.
- **AIRSTAGE** is a worldwide trademarks of FUJITSU GENERAL LIMITED and are registered trademarks in Japan and other countries or areas.
- **nocria** is a worldwide trademark of FUJITSU GENERAL LIMITED.
- **PGlair** is a worldwide trademark of FUJITSU GENERAL LIMITED.
- "DUAL BLASTER & device" is a worldwide trademark of FUJITSU GENERAL LIMITED and is a registered trademark in Japan and other countries or areas.
- iPhone and iPod touch are trademarks of Apple Inc., registered in the U.S. and other countries.
- "Microsoft", "Windows", "Direct X" are trademarks of Microsoft Corporation in the United States and certain other countries.
- IntesisHome® is a registered trademark of Intesis Software S.L.
- "BACnet" is a trademark or registered trademark of the American Society of Heating, Refrigerating and Air-Conditioning Engineers, Inc.
- "MODBUS" is a registered trademark of Schneider Electric.
- "LONWORKS" and Echelon are trademarks of Echelon Corporation registered in the United states and other countries.
- Adobe® Reader® is either registered trademarks or trademarks of Adobe Systems Incorporated in the United States and/or other countries.
- Other company and product names mentioned herein may be registered trademarks, trademarks or trade names of their respective owners.

Distributed by:

