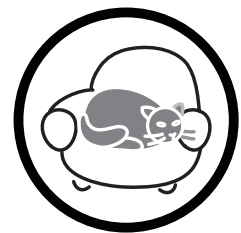
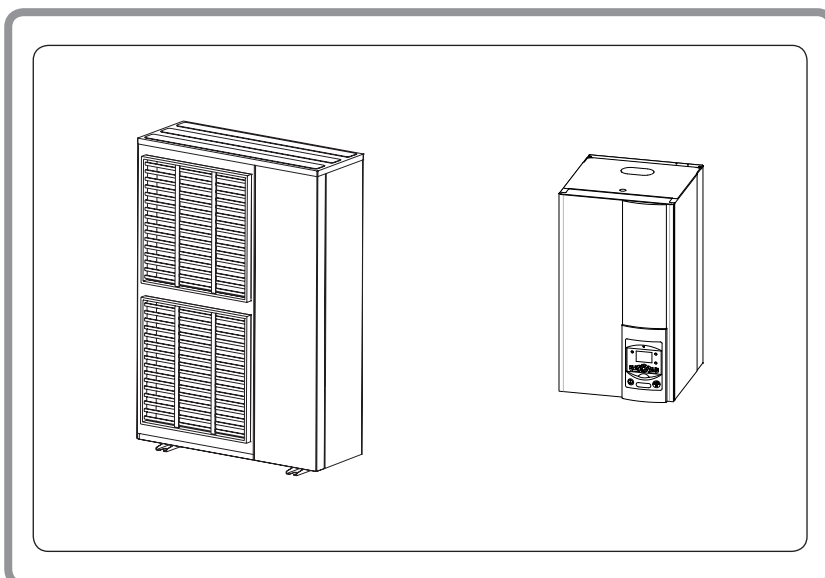
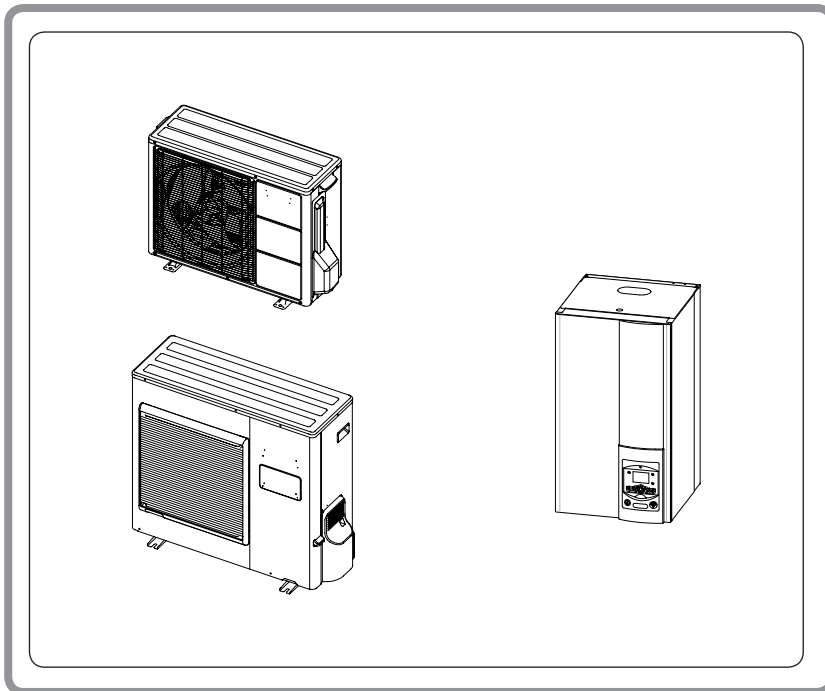


Air to Water Heat Pump

Split system



Operation manual
intended for professionals
and end users.

To be saved for
future consultation

Fujitsu General (Euro) GmbH
Wertstrasse 20
40549 Düsseldorf - Germany

Subject to modifications without notice.
Non contractual document.

Packing list

Heat Pump	Outdoor Unit	Hydraulic Unit
Model	Reference	Reference
Waterstage Comfort 5	WO*A060LDC	WS*A050DD6
Waterstage Comfort 6	WO*A060LDC	WS*A100DD6
Waterstage Comfort 8	WO*A080LDC	
Waterstage Comfort 10	WO*A100LDT	
Waterstage High Power 112 single phase	WO*G112LCT	WS*G140DC6
Waterstage High Power 140 single phase	WO*G140LCT	
Waterstage High Power 112 3-phase	WO*K112LCT	WS*K160DC9
Waterstage High Power 140 3-phase	WO*K140LCT	
Waterstage High Power 160 3-phase	WO*K160LCT	

Contents

Instructions to be read before using the equipment. 3

Safety instructions 3	Precautions and warnings regarding your installation. 4
Start-up 3	The outdoor unit 4
Use 3	The hydraulic unit. 4
Maintenance 3	Control system 4
	The radiators 4
	Floor-heating systems 4
	Fan convectors with integrated control system . . 4
	Domestic hot water (DHW) 4

Overall view of the installation 5

Operation of the installation. 6

User interface, Remote control (option) and Room thermostat (option). 6	Parametering the setting 12
Description of the display 8	General 12
Appliance start up 9	Setting parameters 12
Quick start-up 9	List of "End user" settings 12
Setting the time 10	Information display 16
Structure of the "End user" control menu 11	Details 16
	Operation of the DHW system. 17
	Selecting cooling mode 17
	Pilot-wire. 17
	Telephone modem. 17
	Configuring remote control (option) 17

Maintenance 18

Regular checks 18
Checking the outdoor unit 18

1 Instructions to be read before using the equipment

Please comply with the following instructions in order to avoid any risk of injury or inappropriate use of the appliance.

1.1 Safety instructions

1.1.1 Start-up

- ☞ Do not switch the appliance on until every fillings have been done.
- ☞ Do not try to install this appliance yourself.
- ☞ This heat pump requires an appropriately qualified person to install it.
- ☞ The installation must always be connected to the Earth and fitted with a protective circuit breaker.
- ☞ Do not modify the electricity supply.
- ☞ The appliances are not fireproof and should therefore not be installed in a potentially explosive atmosphere.

1.1.2 Use

- ☞ Do not let children insert foreign bodies into the fan protection grill or climb on top of the outdoor unit. The fins on the air exchanger are extremely fine and cause cuts.
- ☞ Nothing should obstruct the air circulation through the evaporator and from the fan.
- ☞ The outdoor unit must only be installed outdoor (outdoors). If a shelter is required, it must have broad openings on the 4 walls and observe the installation clearances (see with your installer).
- ☞ Do not climb on the top of the outdoor unit.
- ☞ The room in which the appliance is operating must be correctly ventilated in order to prevent any loss of oxygen if there is an escape of refrigerant gas.
- ☞ Consult your Installer before making any changes or modifications to the premises where the appliance is installed.
- ☞ Do not place any heat source under the remote control.

1.1.3 Maintenance

- ☞ Do not try to repair this appliance yourself.
- ☞ This appliance does not contain any components capable of being repaired by the user himself. Removing one or other of the covers can expose you to dangerous electrical voltages.
- ☞ In any case, switching off the current is not sufficient to protect you from any external electrical shocks (capacitors).
- ☞ Do not open the outdoor unit or the hydraulic unit while they are operating.
- ☞ Switch off the power supply if there are any abnormal noises, smells or smoke coming from the appliance and contact your installer.
- ☞ Switch off the power to the appliance before you clean it.
- ☞ Do not use aggressive cleaning liquid or solvents to clean the body work.
- ☞ Do not use a pressure washer to clean the outdoor unit. This could damage the air exchanger and the water might penetrate into the electrical circuits.

1.2 Precautions and warnings regarding your installation.

1.2.1 The outdoor unit

The outdoor unit contains the equipment for capturing energy from the ambient air.

Your installer has placed this unit in a location that enables it to operate in an optimum manner.

Nothing should obstruct the air circulation through the evaporator and from the fan.

The control system for your heating system is designed in flow temperature for the water based on the outdoor temperature (water control).

In cold periods, this water freezes in contact with the exchanger and is drained away by regular defrosting cycles. The control system automatically controls the defrosting cycle, whose operation can lead to the quite normal emission of steam.

1.2.2 The hydraulic unit

The hydraulic unit contains the heat pump complete control system, in charge of controlling the heating comfort level and the production of domestic hot water (if the installation is fitted with a DHW tank with electrical back-up heating).

The heat pump is equipped with an electric back-up system, which is designed to provide additional heat during the coldest periods.

1.2.3 Control system

Your installer has carefully adjusted your installation. Do not modify setting parameters without his agreement. If in doubt, do not hesitate to contact him.

The control system for your heating system is designed in flow temperature for the water based on the outdoor temperature (water control).

The installation of a room thermostat (option) allows to improve operation of the regulation (the influence of the room temperature is taken into account).

The frost protection works in all modes of operation and has priority over other functions (provided that the heat pump's electrical power supply is not interrupted).

☞ **Warning ! In winter, in case of power failure, the frost protection is no longer assured.**

The water in the tank of the hydraulic module can freeze and cause damage.

1.2.4 The radiators

To ensure the function of the regulation with room influence, it's necessary that the room in which the room thermostat is installed has no thermostatic valve or that they must be completely open.

1.2.5 Floor-heating systems

New floor-heating systems require to be initially heated slowly to avoid any problems with cracking. Check with your installer that this initial heating procedure has indeed been performed before using your heating system freely.

The great stability in a regulation system for floor-heating systems avoids sharp differences in temperature. However, this stability involves a reaction time of the order of several hours, (approx 6 hours).

Any changes to the setting must be made slowly, leaving the installation time to react. Adjusting the system to exaggerated setting or in an untimely manner always results in significant temperature fluctuations during course of the day.

Similarly if your dwelling has a floor-heating system, do not reduce the heating or switch it off if you will be absent for a short period. The reheating period is always quite long (approx 6 hours).

1.2.6 Fan convectors with integrated control system

Do not use a room sensor in the area.

1.2.7 Domestic hot water (DHW)

This function is designed as an option through the use of a DHW tank with electrical back-up heating.

When the DHW production is required, the heat pump adapts to this demand with higher priority.

No space heating is produced while the domestic hot water is being prepared.

Domestic hot water (DHW) is produced by the heat pump and then topped up, if necessary, by electrical backup heating or the boiler.

To ensure a DHW setting over 45°C, the electrical back-up heating or the boiler must be left on (Optional boiler connection kit).

The electrical back-up heating enables anti-legionella cycles to be conducted efficiently.

2 Overall view of the installation

Your heat pump has been configured by your installer. It is composed of the following main elements:

- The outdoor unit is positioned, as its name indicates, outside your dwelling and extracts energy from the outside air.
- The hydraulic unit positioned in your boiler room, cellar, garage or even your kitchen, transfers the energy to the heating circuit (and the domestic hot water).
- The outdoor sensor detects the outdoor temperature.

Optional equipment:

- Room thermostat.
- Remote control.

Heat pumps are systems that can be connected to any form of **low temperature heat distribution systems** : the heat captured by the heat pump can therefore be used in different ways:

- Floor-heating systems.
- Radiators or fan coil heaters.
- Domestic hot water (DHW).
- The pool.

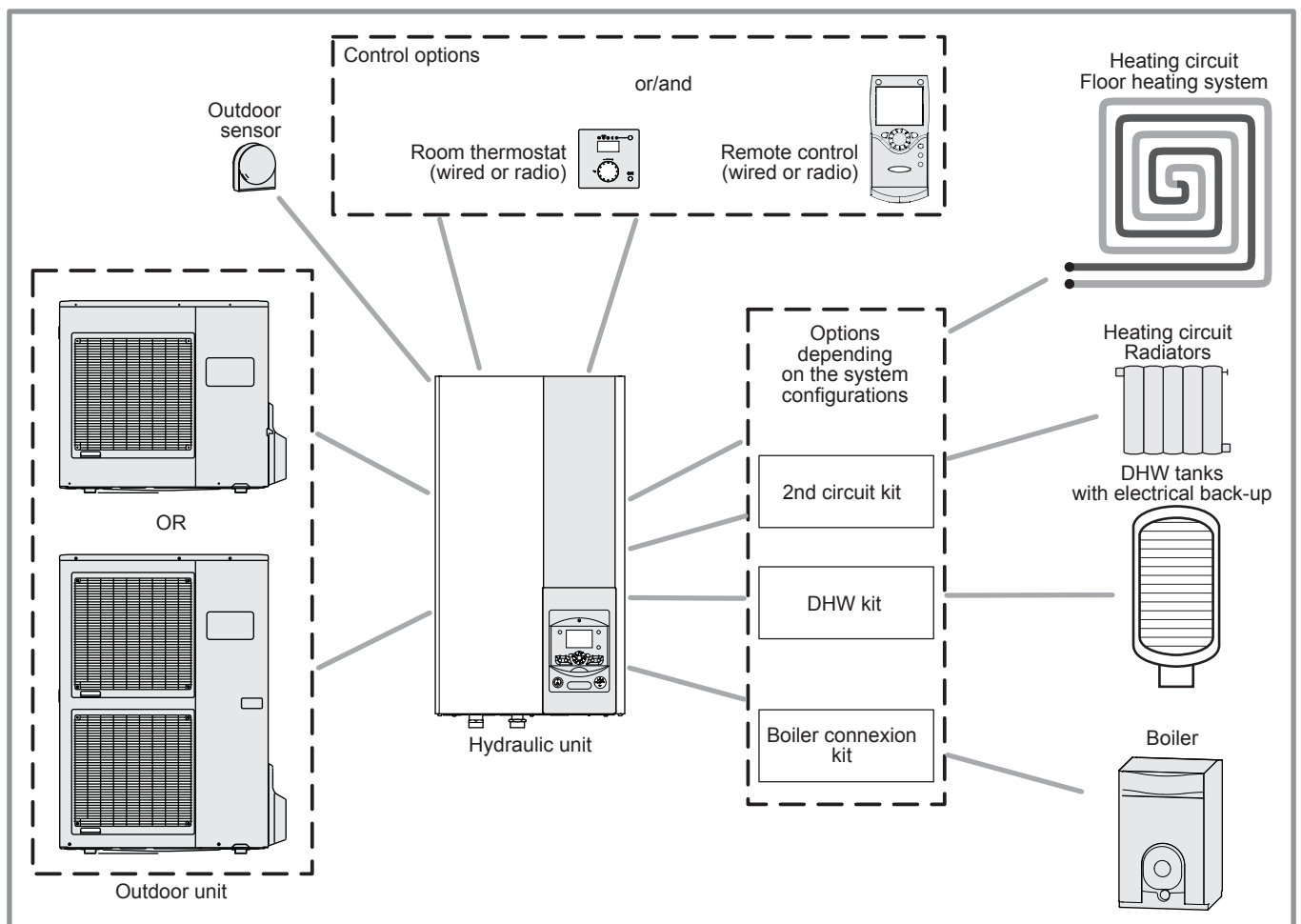


figure 1 - Overall view of the configuration of a complete installation

3 Operation of the installation

3.1 User interface, Remote control (option) and Room thermostat (option)

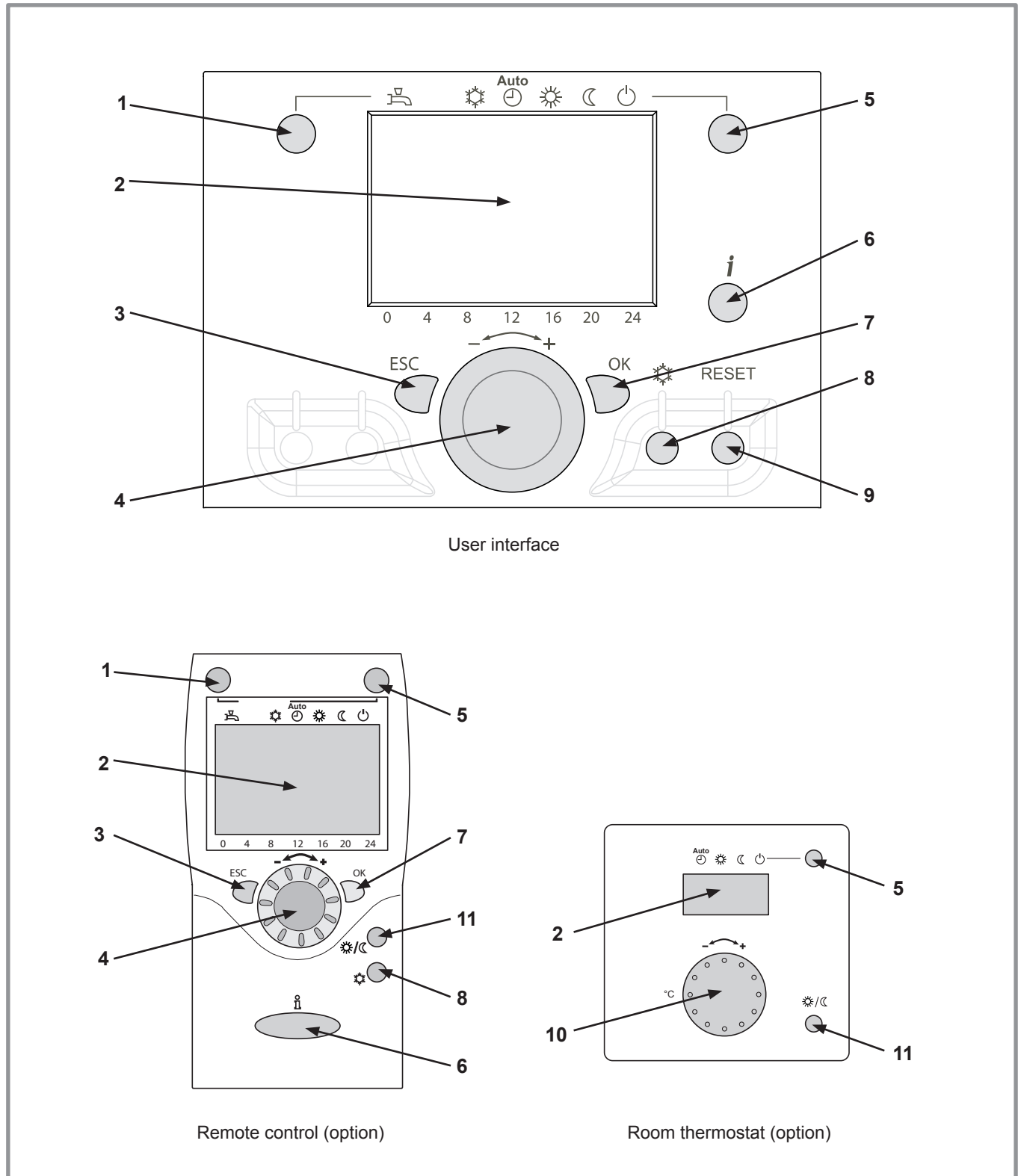












figure 2 -

Ref.	Functions	- Definitions
1	Selecting of the DHW operating mode (Domestic hot water).  On  Off	<ul style="list-style-type: none"> - If the installation is fitted with a DHW tank. - On: Production of DHW according to the time program. - Off: Preparing the domestic hot water for stopping with the anti-frost function active. - Manual start button: Hold down the DHW key for 3 seconds. Switch from "reduced" to "comfort" until the next time the ECS timer switches over.
2	Digital display.	<ul style="list-style-type: none"> - Operating control. Readout of the current temperature, of the heating mode and of any faults . - View the settings.
3	Exit "ESC".	<ul style="list-style-type: none"> - Quit the menu.
4	Navigation and setting.	<ul style="list-style-type: none"> - Selecting the menu. - Setting parameters. - Adjusting the ambient temperature setpoint.
5	Selecting the heating mode.	<ul style="list-style-type: none"> -  Heating operating according to the heating program (Summer/winter mode switchover is automatic). -  Constant comfort temperature. -  Constant reduced temperature. -  Stand-by mode with anti-frost protection (Provided that the heat pump's electrical power supply is not interrupted).
6	Information display.	<ul style="list-style-type: none"> - Various data (see page 16). -  Reading error codes (see Installation and operating manual). -  Information concerning maintenance, special mode.
7	Confirm "OK".	<ul style="list-style-type: none"> - Input into the selected menu. - Confirmation of the parameter settings. - Confirmation of the adjustment to the comfort temp. setting.
8	Selecting cooling mode.	<ul style="list-style-type: none"> - If the installation is fitted with the cooling kit: -  Cooling operating according to the heating program (Summer/winter mode switchover is automatic).
9	RESET button (Hold down the "RESET" key for 3 sec).	<ul style="list-style-type: none"> - Reinitialising the parameters and cancelling error messages. <p>Do not use during normal operation.</p>
10	Control knob.	<ul style="list-style-type: none"> - Adjusting the ambient temperature setpoint.
11	Presence key.	<ul style="list-style-type: none"> - Comfort / Reduced switchover.

3.2 Description of the display

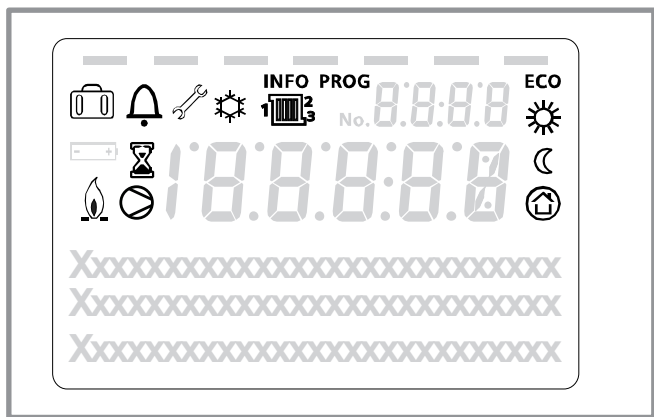


figure 3 -

Symbols	Definitions
	- Heating mode active with reference to the heating circuit.
	- Heating in comfort mode.
	- Heating in reduced mode.
	- Heating in "standby" mode (freeze protection).
	- Cooling mode active.
	- Holiday mode activated.
	- Process in progress.
	- Compressor operation.
	- Burner operation.
	- Default message.
	- Service / Special operation.
INFO	- Information level activated.
PROG	- Program activated.
ECO	- ECO mode activated (Heating temporarily stopped).
	- Hour / Parameter number / Setpoint value.
	- Room temperature / Setpoint value.
	- Setpoint information / Parameter Information.

3.3 Appliance start up

- The installation and 1st start up of the appliance must be done by a qualified installer. That person will also give you instructions on starting and running the appliance.
- Ensure that the installation is fully filled with water and has been correctly bled and that there is a sufficient pressure of 1,5 to 2 bars on the manometer (ref. 2, figure 4).
- Close the installation's main circuit breaker.

In winter, so that the compressor can be preheated, close the installation's main circuit breaker (outdoor unit's power supply) some hours before pressing the on/off button.

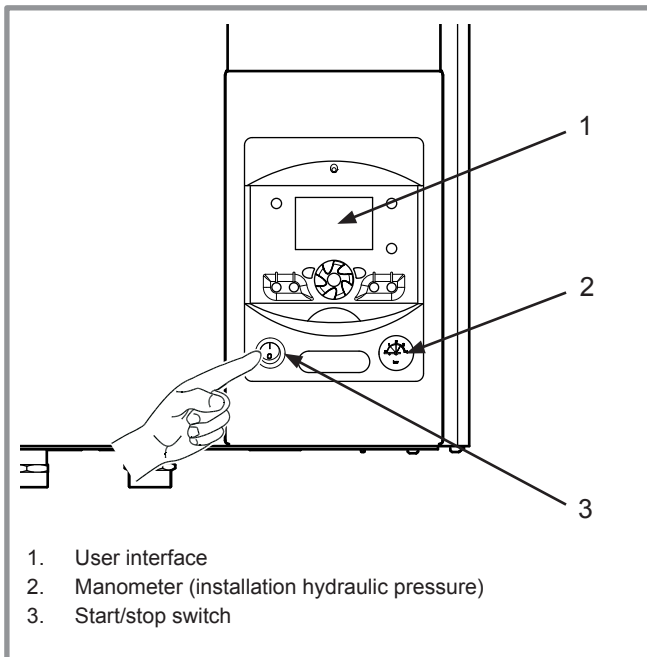


figure 4 - Start-up

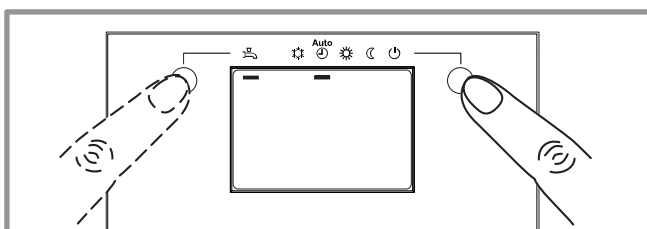


figure 5 - Selecting the heating mode AUTO and Select the DHW mode

3.4 Quick start-up

Once your installer has started your installation for the first time:

- Engage the start/stop switch.

During the regulator initialisation phase, the display shows all the symbols and then "Data, update" and then "State heat pump".
- Select the "AUTO" heating mode (figure 5).
- Select the DHW mode (figure 5).
- Adjust the date and time if necessary (figure 6).

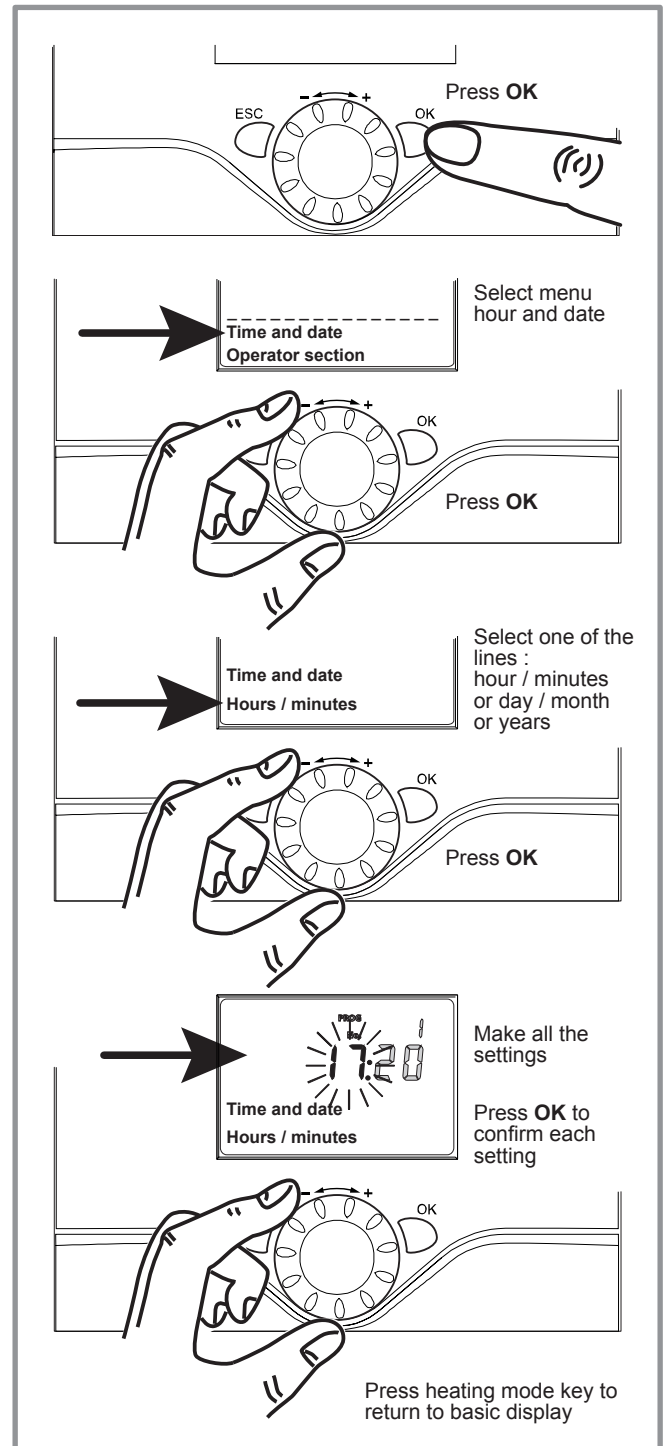


figure 6 - Setting the time and the date

3.5 Setting the time

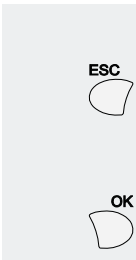
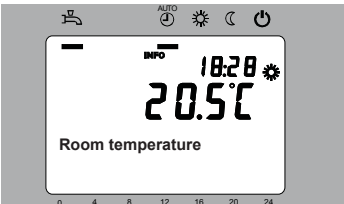
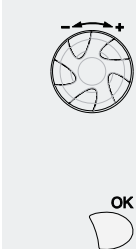
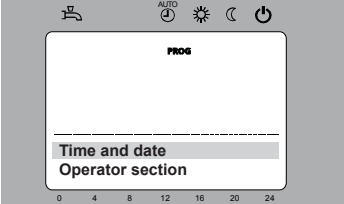
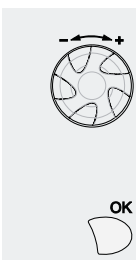
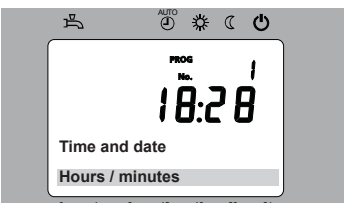

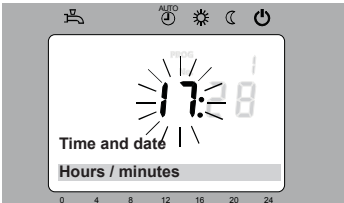
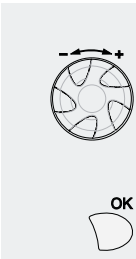
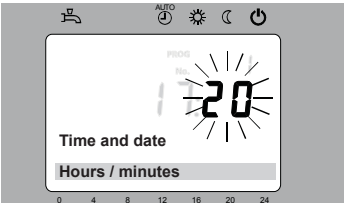
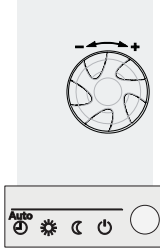
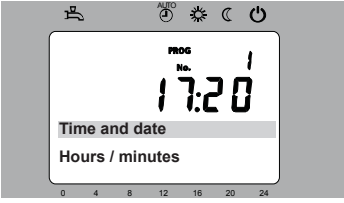
Keys	Display example	Description
<p>1</p> 		<p>Basic display</p> <p>If the basic display is not shown, press ESC to return to it</p> <p>Press OK to confirm.</p>
<p>2</p> 		<p>Turn the knob</p> <p>Select menu hour and date</p> <p>Press OK to confirm.</p>
<p>3</p> 		<p>Turn the knob</p> <p>Select line 1 Hours / minutes</p> <p>Press OK to confirm.</p>
<p>4</p> 		<p>The hour display flashes</p> <p>Turn the knob to set the time</p> <p>Press OK to confirm.</p>
<p>5</p> 		<p>The minutes display flashes</p> <p>Turn the knob to set the minutes</p> <p>Press OK to confirm.</p>
<p>6</p> 		<p>The setting are recorded</p> <p>Turn the knob to make other settings</p> <p>or</p> <p>Press heating Mode key to return to basic display.</p>

figure 7 -

3.6 Structure of the "End user" control menu

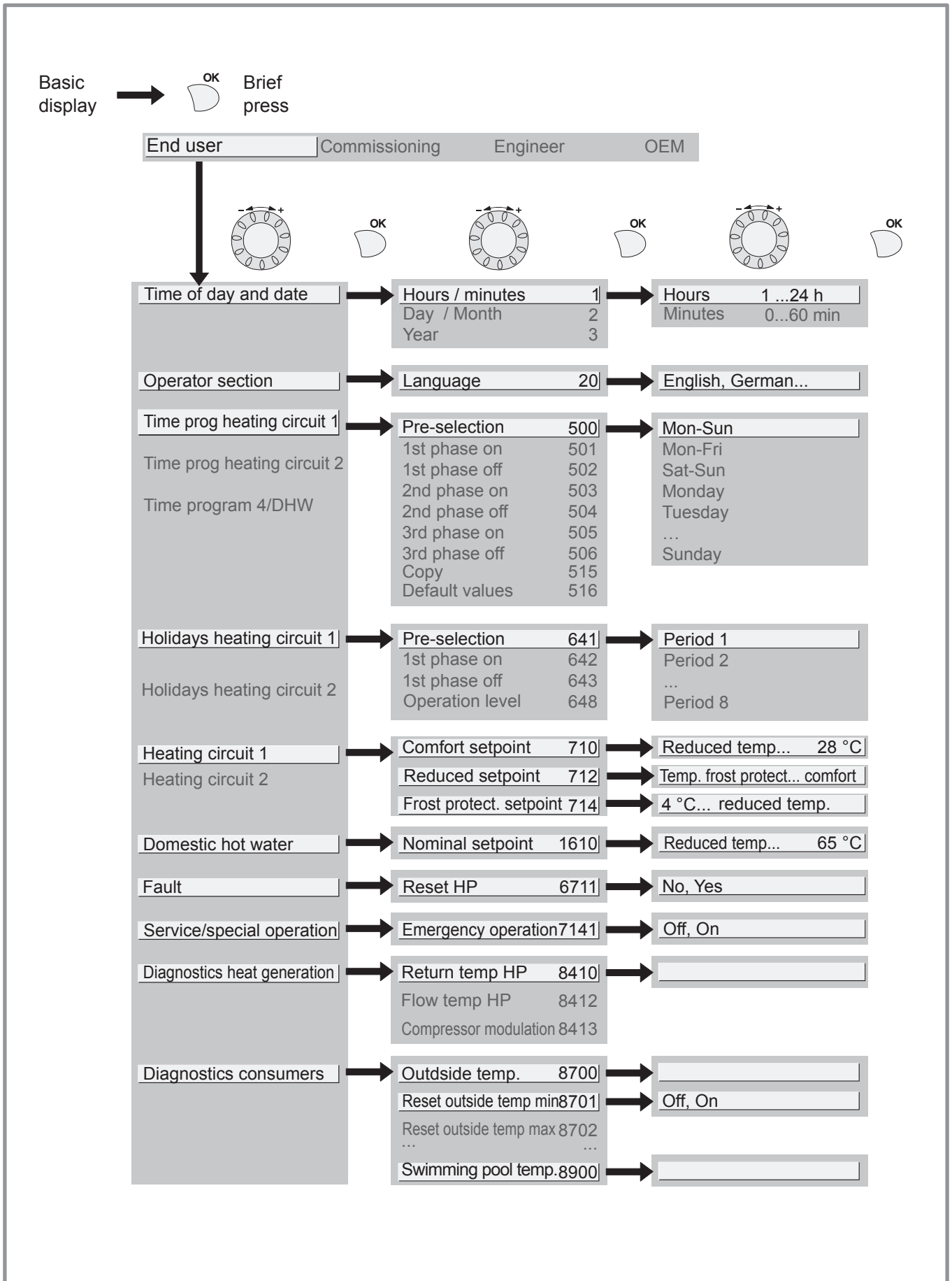


figure 8 -

3.7 Parametering the setting

3.7.1 General

Only the parameters accessible to levels:

End user

... are described in this document.

The parameters accessible at level:

Commissioning

Engineer

... are described in the document reserved for these professional specialists. **Do not make any modifications to these parameters without advice from these professional specialists. Incorrect use of any kind may result in serious malfunctioning.**

3.7.2 Setting parameters

With the screen on basic display.

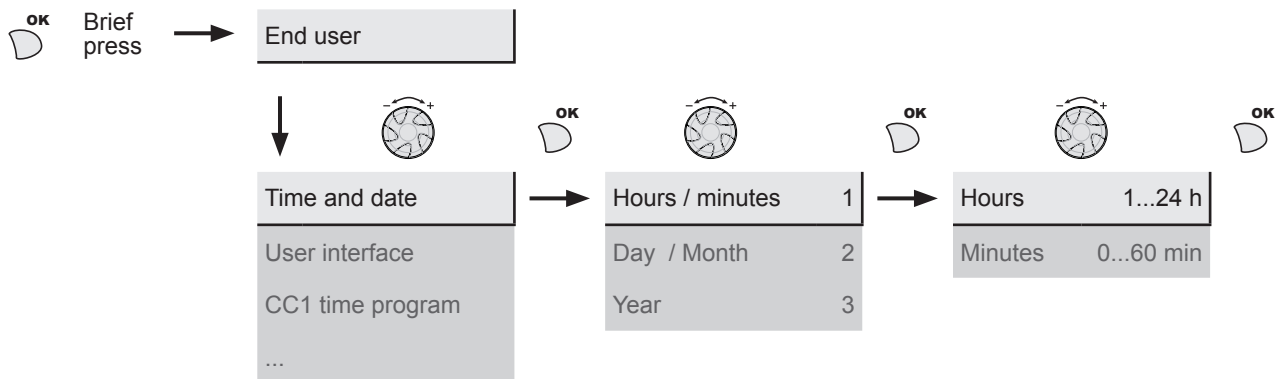
- Press **OK**.

Once in "End user" level.

- Scroll the menu list.
- Choose the desired menu.
- Scroll the function lines.
- Choose the desired line.
- Adjust the parameter.
- Check the setting by pressing **OK**.

- To return the menu, press **ESC**.

If no setting is made for 8 minutes, the screen returns automatically to the basic display.



3.7.3 List of "End user" settings

Line	Function	Setting range or display	Setting increment	Basic setting
Time of day and date				
1	Hours / minutes	00:00... 23:59	1	
2	Day / Month	01.01... 31.12	1	
3	Year	1900... 2099	1	
Operator section				
20	Language	English, Deutsch, Français, Italiano, Nederlands,...		English

<i>Line</i>	<i>Function</i>	<i>Setting range or display</i>	<i>Setting increment</i>	<i>Basic setting</i>
Time program heating, circuit 1				
500	Pre-selection (Day / Week)	Mon-Sun, Mon-Fri, Sat-Sun, Monday, Tuesday, ...		Mon-Sun
501	1st phase On (start)	00:00... --:--	10 min	6:00
502	1st phase Off (end)	00:00... --:--	10 min	22:00
503	2nd phase On (start)	00:00... --:--	10 min	--:--
504	2nd phase Off (end)	00:00... --:--	10 min	--:--
505	3rd phase On (start)	00:00... --:--	10 min	--:--
506	3rd phase Off (end)	00:00... --:--	10 min	--:--
515	Copy			
516	Default values	No, Yes		No
Yes + OK: The default values memorised in the regulator replace and cancel the customised heating programs. Your customised settings are therefore lost.				
Time program heating, circuit 2				
Only with the 2nd circuit kit option.				
520	Pre-selection (Day / Week)	Mon-Sun, Mon-Fri, Sat-Sun, Monday, Tuesday, ...		Mon-Sun
521	1st phase On (start)	00:00... --:--	10 min	6:00
522	1st phase Off (end)	00:00... --:--	10 min	22:00
523	2nd phase On (start)	00:00... --:--	10 min	--:--
524	2nd phase Off (end)	00:00... --:--	10 min	--:--
525	3rd phase On (start)	00:00... --:--	10 min	--:--
526	3rd phase Off (end)	00:00... --:--	10 min	--:--
535	Copy			
536	Default values	No, Yes		No
Yes + OK: The default values memorised in the regulator replace and cancel the customised heating programs. Your customised settings are therefore lost.				
Time program 4 / DHW				
If the installation is fitted with the DHW kit (Only with the DHW kit option).				
560	Pre-selection (Day / Week)	Mon-Sun, Mon-Fri, Sat-Sun, Monday, Tuesday, ...		Mon-Sun
561	1st phase On (start)	00:00... --:--	10 min	00:00
562	1st phase Off (end)	00:00... --:--	10 min	05:00
563	2nd phase On (start)	00:00... --:--	10 min	14:30
564	2nd phase Off (end)	00:00... --:--	10 min	17:00
565	3rd phase On (start)	00:00... --:--	10 min	--:--
566	3rd phase Off (end)	00:00... --:--	10 min	--:--
575	Copy			
576	Default values	No, Yes		No
Yes + OK: The default values memorised in the regulator replace and cancel the customised heating programs. Your customised settings are therefore lost.				


<i>Line</i>	<i>Function</i>	<i>Setting range or display</i>	<i>Setting increment</i>	<i>Basic setting</i>
Time program 5 / Cooling				
If the installation is fitted with the cooling kit (Only with the cooling kit option).				
600	Pre-selection (Day / Week)	Mon-Sun, Mon-Fri, Sat-Sun, Monday, Tuesday, ...		Mon-Sun
601	1st phase On (start)	00:00... --:--	10 min	8:00
602	1st phase Off (end)	00:00... --:--	10 min	20:00
603	2nd phase On (start)	00:00... --:--	10 min	--:--
604	2nd phase Off (end)	00:00... --:--	10 min	--:--
605	3rd phase On (start)	00:00... --:--	10 min	--:--
606	3rd phase Off (end)	00:00... --:--	10 min	--:--
615	Copy			
616	Default values	No, Yes		No
Yes + OK: The default values memorised in the regulator replace and cancel the customised heating programs. Your customised settings are therefore lost.				
Holidays, heating circuit 1 (For the Holiday program is active, the heating mode should be on AUTO).				
641	Preselection	Period 1 to 8		Period 1
642	Period Start (Day / Month)	01.01... 31.12	1	
643	Period End (Day / Month)	01.01... 31.12	1	
648	Operating level	Frost protection, Reduced		Frost protection
Holidays, heating circuit 2 (For the Holiday program is active, the heating mode should be on AUTO).				
If the installation consists of 2 heating circuits (Only with the 2nd circuit kit option).				
651	Preselection	Period 1 to 8		Period 1
652	Period Start (Day / Month)	01.01... 31.12	1	
653	Period End (Day / Month)	01.01... 31.12	1	
658	Operating level	Frost protection, Reduced		Frost protection
Heating, circuit 1				
710	Comfort setpoint	Reduced setpoint... 28 °C	0,5 °C	20 °C
712	Reduced setpoint	Frost protection setpoint... Comfort setpoint	0,5 °C	19 °C
714	Frost protection setpoint	4 °C... Reduced setpoint	0,5 °C	8 °C
Cooling circuit 1				
If the installation is fitted with the cooling kit (Only with the cooling kit option).				
901	Operating mode	Off, Automatic		Off
902	Comfort cooling setpoint	17... 40 °C	0,5 °C	24 °C
907	Release	24h/day, Time program HC, Time program 5 / Cooling		Time program 5
If the installation is fitted with a DHW tank, set the parameter 907 to "Time program 5 / Cooling" (In order to activate cooling only during the day and leave the DHW system to operate during the night).				
Heating, Circuit 2				
Only with the 2nd circuit kit option (If the installation consists of 2 heating circuits).				
1010	Comfort setpoint	Reduced setpoint... 28 °C	0,5 °C	20 °C
1012	Reduced setpoint	Frost protection setpoint... Comfort setpoint	0,5 °C	19 °C
1014	Frost protection setpoint	4°C... Reduced setpoint	0,5 °C	8 °C

<i>Line</i>	<i>Function</i>	<i>Setting range or display</i>	<i>Setting increment</i>	<i>Basic setting</i>
Domestic hot water				
If the installation is fitted with the DHW kit (Only with the DHW kit option).				
1610	Nominal setpoint	Reduced setpoint (line 1612)... 65 °C	1	55 °C
The backup electrical system is required to reach this level.				
1612	Reduced setpoint	8 °C... Nominal setpoint (line 1610)	1	40 °C
Swimming pool (Only with swimming pool kit option)				
2056	Setpoint source heating	8... 35 °C		22 °C
Error				
6711	Reset HP	No, Yes		No
Maintenance / special regime				
7141	Emergency operation	Off, On		Off
Off: Heat pump functions normally (with boosters if necessary). On: Heat pump uses the electric boost system or the boiler connection. Use the "On" position only in Assist mode or Test mode: may result in high power bills.				
Diagnostics heat generation				
8410	Return temp HP	0... 140 °C		
	Setpoint (flow) HP			
8412	Flow temp HP	0... 140 °C		
	Setpoint (flow) HP			
8413	Compressor modulation	0... 100%		
Diagnostics consumers				
8700	Outside temperature	-50... 50 °C		--
8701	Outside temp min Reset ? (no, yes)	-50... 50 °C		--
8702	Outside temp max Reset ? (no, yes)	-50... 50 °C		--
8740	Room temperature 1	0... 50 °C		--
	Room setting 1			20 °C
8743	Flow temperature 1	0... 140 °C		--
	Flow temperature setpoint 1			--
8756	Cooling flow temperature 1	0... 140 °C		--
	Cooling flow temperature setpoint 1			--
8770	Room temperature 2	0... 50 °C		--
	Room setpoint 2			20 °C
8773	Flow temperature 2	0... 140 °C		--
	Flow temperature setpoint 2			--
8830	DHW (domestic hot water) temperature	0... 140 °C		--
	DHW temperature setpoint			50 °C
8900	Swimming pool temperature	0... 140 °C		--
	Swimming pool temperature setpoint			22 °C


3.8 Information display

Various data can be displayed by pressing the info button.

Depending on the type of unit, configuration and operating state, some of the info lines listed below may not appear.

- Possible error messages: The display shows the "Bell" symbol  .

☞ **Consult your heating technician.**

- Service messages ; Special mode messages: The display shows the "Key" symbol  .

☞ **Consult your heating technician.**

- Various data (see below).

<i>Designation</i>	<i>Line</i>
Floor drying current setpoint .	-
Current drying day.	-
Terminated drying days.	-
State heat pump.	8006
State supplementary source.	8022
State DHW.	8003
State swimming pool.	8011
State heating circuit 1.	8000
State heating circuit 2.	8001
State cooling circuit 1.	8004
Outdoor temperature.	8700
Room temperature 1.	8740
Room setpoint 1.	
Flow temperature 1.	8743
Flow temperature setpoint1.	
Room temperature 2.	8770
Room setpoint 2.	
Flow temperature 2.	8773
Flow temperature setpoint 2.	
DHW (domestic hot water) temperature.	8830
Heat pump return temperature.	8410
Setpoint (return) HP.	
Heat pump flow temperature.	8412
Setpoint (flow) HP.	
Swimming pool temperature.	8900
Swimming pool temperature setpoint.	
Minimum remaining stop time for compressor 1.	-
Minimum remaining running time for compressor 1.	-

3.9 Details

If the electrical power supply has been cut off while the heat pump is operating (electrical power failure or unprogrammed pressing of the on/off switch on the hydraulic unit) the display will show error 370 when the appliance restarts. Do not be concerned, the communication between the outdoor and hydraulic unit will re-establish itself in a few moments.

3.10 Operation of the DHW system

The key enables you to switch the DHW (domestic hot water) mode on and off. The selection is shown by a bar, which appears under the corresponding symbol.

Manual activation: Hold down the DHW key for 3 seconds (Switch from "reduced" to "nominal" until the next time the DHW timer switches over).

To ensure a DHW setting over 45°C, the electrical back-up heating or the boiler must be left on.

In order to optimise operation of the DHW, it is possible to:

- Program the timer settings (parameters 560 to 576),
- Adjust the nominal temperature set point (parameter 1610),
- Adjust the reduced temperature set point (parameter 1612).

Press the info key to obtain the details on the DHW (temperature setting operation).

3.11 Selecting cooling mode

If the installation is fitted with the cooling kit.

The key activates and deactivates cooling mode.

3.12 Pilot-wire (if Regulation extension kit AVS 55)

It's possible to order up to 15 electric heaters via output "pilot wire".

The "pilot wire" handles only the hourly operation of radiators (comfort mode / reduced mode commutation and Frost protection mode).

The comfort temperature setting should be done directly on the radiator(s). The "pilot wire" does not handle the temperature of the radiators. Refer to the manual supplied with the radiator(s).

Put the radiators on "**PROG**" mode or "**AUTO**" mode for piloting by the regulation board.

The difference between the comfort temperature and the reduced temperature is from 3,5 °C.

Frost protection temperature is preset at 8°C (parameter 1014).

In the absence of signal (HP on "Off"), radiators operating in comfort mode.

3.13 Telephone modem (if Regulation extension kit AVS 55)

It is possible to command the switching of the heating mode to the freeze protection mode (and vice versa) on the heat pump using a modem contact (e.g. Siemens TEL50.GSM).

The telephone command switches the current heat pump settings to freeze protection mode (and vice versa). In accordance with the setting, any temperature requests from the heating circuits and the DHW are ignored or activated.

The freeze protection mode must not be selected on the heat pump and/or the remote control.

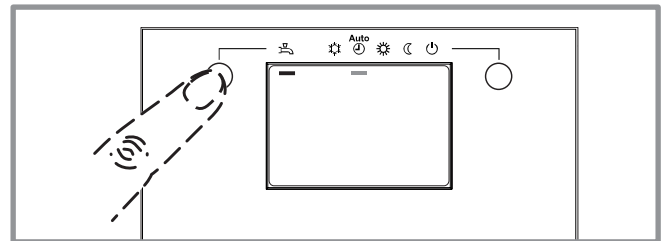


figure 9 - Select the DHW mode

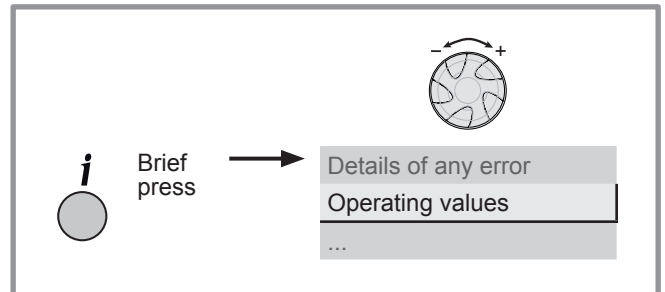


figure 10 - Information key

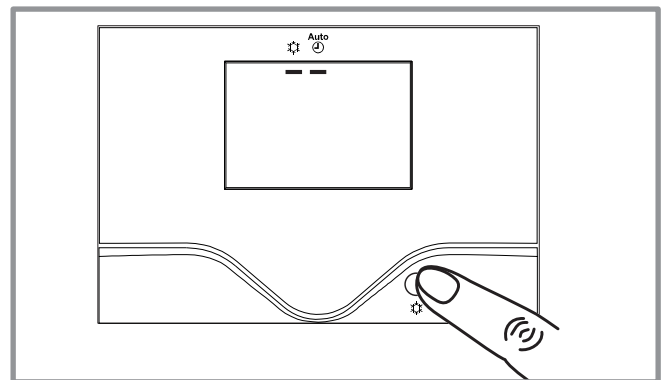


figure 11 - Selecting cooling mode

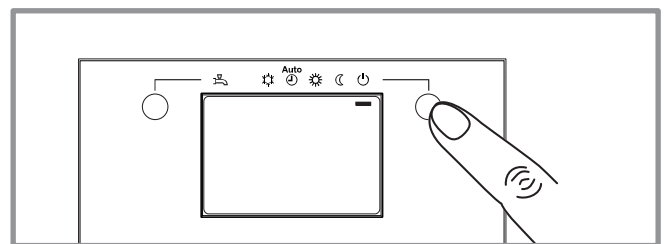


figure 12 - Selecting Frost protection mode

3.14 Configuring remote control (option)

In the event that the remote control (see figure 2), is used, on start-up, after initialising for around 3 minutes, the language needs setting:

- Press **OK**.
- Choose menu "Operator section".
- Choose language "Language" **English**.

4 Maintenance

In order to insure your appliance operates correctly for many years, the maintenance operations described below are required at the start of each heating season. Generally, these are performed as part of a service contract.

4.1 Regular checks

- Periodically check the water pressure in the heating circuit (Refer to the pressure recommended by the installer - between 1 to 2 bar).
- If filling and re-pressurization are required, check what type of fluid has been used initially (If in any doubt, contact your installer).

- If frequent refills are required it is essential that you look for any leaks.
 - ☞ **The frequent water supply is at risk of scaling for the Heat exchanger and degrades performance and longevity of it.**

4.2 Checking the outdoor unit

Dust off the heat exchanger if necessary, being careful not to damage the fins.

Check that there is nothing obstructing the passage of air.

• Checking the refrigeration circuit

When the refrigerant charge is in excess of 2kg (models > 10kW) it is compulsory to have an approved after sales service check the refrigeration circuit every year (with a certificate of capacity for the handling of refrigerants). Consult your heating technician.





This appliance is marked with this symbol. This means that electrical and electronic products shall not be mixed with general household waste. European Community countries(*), Norway, Iceland and Liechtenstein should have a dedicated collection system for these products. Do not try to dismantle the system yourself as this could have harmful effects on your health and on the environment. The dismantling and treatment of refrigerant, oil and other parts must be done by a qualified installer in accordance with relevant local and national regulations. This appliance must be treated at a specialized treatment facility for re-use, recycling and other forms of recovery and shall not be disposed of in the municipal waste stream. Please contact the installer or local authority for more information.
* subject to the national law of each member state

Date of installation :

Contact of your heating technician or your after-sales service.